

Single Shared Platform

User Detailed Functional Specifications

- Core Services -

1st book

Version 13.01

25 October 2019



Table of Contents

1	Management Summary	1
1.1	Introduction	1
1.2	Concept of TARGET2	3
1.3	Role of central banks (CBs) in TARGET2	4
1.4	Scope and framework of TARGET2	5
1.4.1	Overview of core and optional services offered by the SSP	6
1.4.2	Payments Module (PM)	9
1.4.3	Information and Control Module (ICM)	9
1.4.4	Reserve Management (RM) and Standing Facilities (SF)	11
1.4.5	Home Accounting Module (HAM)	11
1.4.6	Statistical information	13
1.4.7	The monetary policy execution	13
2	User Guide for Payments Module (PM)	15
2.1	Participation in and access to TARGET2	15
2.1.1	Direct participation	16
2.1.2	Indirect participation	20
2.1.3	Comparison of direct and indirect participation/access	21
2.1.4	Multi-addressee access (“technical BIC access”)	22
2.1.5	Access as correspondent BICs (“addressable BICs”)	24
2.1.6	Access as T2S Actor in TARGET2	24
2.1.7	Exclusion	25
2.1.7.1	General aspects	25

2.1.7.2	Exclusion of a direct PM participant.....	25
2.1.7.3	Exclusion of an ancillary system (AS).....	31
2.1.8	Directories of the participants	31
2.2	Accounting	32
2.3	Liquidity transfer	36
2.3.1	Liquidity transfer between RTGS and HAM account.....	36
2.3.1.1	Liquidity injection at the start of the business day	36
2.3.1.2	Liquidity transfer during the business day	38
2.3.2	Liquidity transfer between RTGS and proprietary home account (PHA) ...	41
2.3.2.1	Liquidity supply at the start of the business day.....	41
2.3.2.2	Liquidity transfer during the business day	43
2.3.3	Retransfer of liquidity at the end of the business day	45
2.4	Payment types	49
2.4.1	General overview	49
2.4.2	Comparison of different payment types	53
2.4.3	Definition of execution time.....	55
2.4.4	Warehouse functionality.....	57
2.4.5	Backup payments.....	58
2.4.5.1	Backup contingency payments	59
2.4.5.2	Backup liquidity redistribution payments	61
2.5	Liquidity management	63
2.5.1	Reservation facilities	63
2.5.1.1	Highly urgent reserve	63
2.5.1.2	Urgent reserve.....	63
2.5.1.3	Rules for definition of reserves	64
2.5.2	Use of limits	66
2.5.2.1	Bilateral limits	66
2.5.2.2	Multilateral limit.....	67
2.5.2.3	Rules for definition of limits	67

Table of Contents

2.5.3	Dedicated liquidity for AS settlement	69
2.5.4	Effect of reservation and definition of limits (examples)	70
2.5.4.1	Examples for the effects of reservations	70
2.5.4.2	Examples for the effects of limits	75
2.5.5	Pooling of liquidity	79
2.5.5.1	Description and possible options	79
2.5.5.2	Virtual account	82
2.5.5.3	Consolidated information	96
2.6	Flow of payments	98
2.6.1	Payment Interface	99
2.6.2	Payment flow	107
2.6.2.1	Payments sent from a direct PM participant	108
2.6.2.1.1	... to another direct PM participant	109
2.6.2.1.2	... to a participant with indirect access/a participant as an “addressable BIC“	114
2.6.2.1.3	... to a HAM account holder	119
2.6.2.1.4	... to a CB customer (with an account in HAM)	122
2.6.2.1.5	... to an account holder with a PHA	124
2.6.2.2	Payments received by a PM participant	126
2.6.2.2.1	... from a direct PM participant	127
2.6.2.2.2	... from a participant with indirect access/a participant as an “addressable BIC“	131
2.6.2.2.3	... from a HAM account holder	135
2.6.2.2.4	... from a CB customer (with an account in HAM)	137
2.6.2.2.5	... from a participant with a PHA	139
2.6.3	Rejection of payments	141
2.6.3.1	General information	141
2.6.3.2	Incorrect payments	142
2.7	Processing of payments	142
2.7.1	Entry disposition	142
2.7.1.1	General remarks	142

Table of Contents

2.7.1.2	Settlement of payments in the entry disposition	144
2.7.2	Comprehensive queue management.....	150
2.7.3	Dissolution of payment queue.....	155
2.7.3.1	Settlement of queued (highly) urgent payments.....	155
2.7.3.2	Settlement of queued normal payments.....	156
2.7.3.3	Optimisation on sub-accounts.....	169
2.7.4	Processing backup payments	170
2.7.4.1	Generation.....	170
2.7.4.2	Notification to the affected participant (sender).....	171
2.7.4.3	Notification to the receiver	171
2.7.4.4	Treatment in the settlement process	172
2.7.5	Subsequent delivery of single payments	172
2.7.5.1	Transmission of unprocessed payments with new value date	173
2.7.5.2	Transmission of unprocessed payments with original value date	173
2.8	Settlement of ancillary systems	174
2.8.1	Ancillary System Interface	174
2.8.2	Work flow of settlement procedures (liq. trans., real-time, bilat., stand. and simult. multilat.)	190
2.8.2.1	Liquidity transfer	190
2.8.2.2	Real-time settlement	194
2.8.2.3	Bilateral settlement.....	197
2.8.2.4	Standard multilateral settlement	200
2.8.2.5	Simultaneous multilateral settlement	205
2.8.2.6	Optional connected mechanisms.....	209
2.8.3	Work flow of “dedicated liquidity” settlement procedure.....	214
2.8.3.1	General aspects	214
2.8.3.2	Night-time business.....	222
2.8.3.2.1	Night-time business: real-time model	223
2.8.3.2.2	Night-time business: interfaced model.....	232
2.8.3.3	Daylight business	254
2.8.4	Contingency measures	257

2.9	Interconnection with TARGET2 Securities	260
2.9.1	TARGET2 Securities Interface (T2SI)	261
2.9.2	Overview of provided services	263
2.9.2.1	Core services.....	264
2.9.2.2	Value Added Services	266
2.9.3	Flow of Liquidity Transfers	267
2.9.3.1	Push Liquidity to T2S	267
2.9.3.1.1	Standing orders	268
2.9.3.1.2	Current orders by account owner.....	271
2.9.3.1.2.1	Initiation via XML message	271
2.9.3.1.2.2	Initiation via MT message (Value added service)	276
2.9.3.1.2.3	Initiation via ICM	281
2.9.3.1.3	Current orders by T2S Actors in TARGET2 initiated via XML message..	283
2.9.3.2	Incoming Liquidity Transfers from T2S.....	286
2.9.3.3	Pull Liquidity from T2S (Value added service)	288
2.9.3.3.1	Initiation via XML message	290
2.9.3.3.2	Initiation via MT message.....	295
2.9.3.3.3	Initiation via ICM	299
2.9.4	Contingency measures.....	301
2.10	Interconnection with TIPS	302
2.10.1	TIPS Interface (TIPSI)	302
2.10.2	Overview of provided services	304
2.10.2.1	Core services.....	305
2.10.2.2	“Pull” Liquidity from TIPS.....	306
2.10.3	Flow of Liquidity Transfers	307
2.10.3.1	Push Liquidity to TIPS	307
2.10.3.1.1	Standing orders	308
2.10.3.1.2	Current orders by account owner.....	311
2.10.3.1.2.1	Initiation via XML message	311
2.10.3.1.2.2	Initiation via ICM	315
2.10.3.2	Incoming Liquidity Transfers from TIPS.....	317
2.10.3.3	Pull Liquidity from TIPS	319

2.10.3.3.1	Initiation via XML message.....	321
2.10.3.3.2	Initiation via ICM.....	326
2.10.4	Contingency measures	327
3	User Guide for Static Data Module (SD)	329
3.1	General overview	329
3.1.1	Main features.....	329
3.1.2	Users	329
3.1.3	Controls and responsibilities for data.....	330
3.2	Static Data description	331
3.2.1	Participants' structure.....	336
3.2.2	Data for ancillary systems management	340
3.2.3	Specific credit institution data	341
3.2.4	Credit institution specific T2S Static data	342
3.2.5	Credit institution specific TIPS Static data	343
3.2.6	SSP data	343
3.3	Static Data access	344
4	User Guide for Enhanced Contingency Solution (ECONS I)	345
4.1	User administration	352
4.1.1	Use of RBAC	352
4.1.2	Overview of user roles for participants	
4.1.3	Login	353
4.2	Security	354

5	SSP Infrastructure.....	356
5.1	General architecture.....	356
5.2	SWIFT Interface	359
5.3	Contingency Network.....	360
6	Operational model.....	361
6.1	Operating times and operational hours.....	361
6.2	Customer contacts	368
6.3	Problem management and contingency procedures	369
6.4	Restart after disaster	370
6.4.1	Overview.....	370
6.4.2	Technical restart of region 2 as SSP environment	373
6.4.3	Description of the reconstruction process.....	374
6.4.3.1	SWIFT bulk retrieval of FIN messages	374
6.4.3.2	Reconstruction of the PM database	375
6.4.3.2.1	General remarks	375
6.4.3.2.2	Business cases considered.....	375
6.4.3.2.3	Pre-processing	377
6.4.3.2.4	Re-settlement	377
6.4.3.3	Reconstruction of the HAM database	378
6.4.3.3.1	Pre-processing	378
6.4.3.3.2	Re-settlement	379
6.4.3.4	Process in ASI	380
6.4.3.4.1	Pre-processing	380
6.4.3.4.2	Re-settlement	380
6.4.4	Reopening	381

6.4.5	Manual reconciliation - Reporting	382
6.4.5.1	Report to participants related to PM	382
6.4.5.2	Report to participants related to HAM.....	382
6.4.5.3	Nature of information sent related to ASI	383
6.4.6	Conclusion.....	383
7	Information and Control Module (ICM)	384
7.1	Overview on ICM	384
7.2	ICM access	390
7.2.1	ICM access to PM.....	390
7.2.2	ICM access to SD.....	393
7.3	User roles for ICM access	395
7.3.1	Two eyes/four eyes principle	395
7.3.2	User roles in A2A	397
7.3.3	User roles in U2A	397
8	Enhanced Contingency Solution (ECONS I) -User Handbook	406
8.1	Business approach of ECONS I	406
8.2	Functions available in ECONS I	407
9	Technical Specifications	409
9.1	SWIFTNet FIN related issues	409

Table of Contents

9.1.1	SWIFTNet FIN - General aspects	409
9.1.1.1	Business Identifier Codes (BICs) for SSP	409
9.1.1.2	Public Key Infrastructure (PKI)	415
9.1.1.3	SWIFTNet FIN messages	416
9.1.1.3.1	Structure	416
9.1.1.3.2	Formatting rules for fields	417
9.1.2	SWIFTNet FIN Messages - Details	418
9.1.2.1	Header and Trailer	418
9.1.2.1.1	Header	418
9.1.2.1.1.1	Basic Header	418
9.1.2.1.1.2	Application Header	419
9.1.2.1.1.3	User Header	421
9.1.2.1.2	Trailer	428
9.1.2.1.2.1	General description	428
9.1.2.1.2.2	Handling of PDMPDE Trailer	431
9.1.2.2	Textblock of the different message types	437
9.1.2.2.1	Payment messages	437
9.1.2.2.1.1	MT 103	437
9.1.2.2.1.2	MT 103+	442
9.1.2.2.1.3	MT 202	447
9.1.2.2.1.4	MT 202 COV	457
9.1.2.2.1.5	MT 204	463
9.1.2.2.2	Cash flow management messages	466
9.1.2.2.2.1	MT 900	466
9.1.2.2.2.2	MT 910	474
9.1.2.2.2.3	MT 940	484
9.1.2.2.2.4	MT 950	491
9.1.2.3	SWIFT system messages	498
9.1.2.3.1	MT 012	498
9.1.2.3.2	MT 019	500
9.1.2.4	Examples for addressing payments	502
9.1.2.4.1	Payments among PM participants	504
9.1.2.4.2	Payments between HAM and PM	509

9.1.2.4.3	Payments with proprietary home accounts.....	513
9.1.2.4.4	Liquidity transfers with T2S.....	518
9.2	SWIFTNet InterAct and FileAct related issues.....	519
9.2.1	Overview.....	519
9.2.2	How to use the application-to-application approach	527
9.2.3	Common use cases	527
9.2.3.1	System time.....	528
9.2.3.2	Get tasks	528
9.2.3.3	Get pending data.....	529
9.2.3.4	Broadcasts.....	529
9.2.4	Use cases for Payments Module	530
9.2.4.1	Liquidity management.....	530
9.2.4.1.1	Account information on	530
9.2.4.1.1.1	... account in PM.....	530
9.2.4.1.1.2	... proprietary home account	531
9.2.4.1.2	Credit line	532
9.2.4.1.3	Liquidity transfer between	532
9.2.4.1.3.1	... accounts of the same participant.....	532
9.2.4.1.3.2	... two accounts of a group of accounts	534
9.2.4.1.4	Standing order liquidity transfer	535
9.2.4.1.4.1	Get standing order liquidity transfer	535
9.2.4.1.4.2	Define standing order liquidity transfer	536
9.2.4.1.4.3	Modify standing order liquidity transfer	537
9.2.4.1.5	Limit management.....	539
9.2.4.1.5.1	Get limit	539
9.2.4.1.5.2	Define limit.....	540
9.2.4.1.5.3	Modify standing order limit	541
9.2.4.1.5.4	Modify current limit	542
9.2.4.1.5.5	Delete standing order limits	543
9.2.4.1.5.6	Delete current limit	543
9.2.4.1.5.7	Modify all / several current bilateral limits	544

Table of Contents

9.2.4.1.5.8	Modify all / several standing order limits and define several standing order limits	545
9.2.4.1.5.9	Delete all / several current bilateral limit	546
9.2.4.1.5.10	Delete all / several standing order limits	547
9.2.4.1.6	Reservations.....	547
9.2.4.1.6.1	Get reservations	547
9.2.4.1.6.2	Define current reservation	548
9.2.4.1.6.3	Define standing order reservation	549
9.2.4.1.6.4	Modify current reservation.....	550
9.2.4.1.6.5	Delete current reservation	551
9.2.4.1.6.6	Modify standing order reservation.....	552
9.2.4.1.7	Levelling out sequence.....	553
9.2.4.1.7.1	Get levelling out sequence	553
9.2.4.1.7.2	Define/Modify levelling out sequence	554
9.2.4.2	Management of payment queue	555
9.2.4.2.1	Get payment	555
9.2.4.2.2	Cancel payment.....	557
9.2.4.2.3	Reordering of payments	558
9.2.4.2.4	Change priority	559
9.2.4.2.5	Change execution time.....	560
9.2.4.3	Liquidity Redistribution/contingency payments.....	561
9.2.4.4	Business day information	562
9.2.5	Use cases for Static Data.....	563
9.2.5.1	Get legal entity.....	563
9.2.5.2	Get CB	564
9.2.5.3	Get participant	564
9.2.5.4	Get T2WildCard.....	565
9.2.5.5	Get RTGS account	566
9.2.5.6	Get direct debit	566
9.2.5.7	Get sub-account	567
9.2.5.8	Get group of accounts	567
9.2.5.9	Get contact item	568
9.2.5.10	Get AS	569

Table of Contents

9.2.5.11	Get AS settlement bank	569
9.2.5.12	Get TARGET events	570
9.2.5.13	Get calendar	571
9.2.5.14	Get error codes	571
9.2.6	Use cases for AS.....	572
9.2.6.1	Payment orders sent by AS to ASI	572
9.2.6.2	Liquidity adjustment sent by settlement bank via ICM for real-time models	575
9.2.6.3	Liquidity adjustment sent by settlement bank via ICM for interfaced models	576
9.2.6.4	Specific orders sent by CB via ASI	577
9.2.6.5	Notice received by Real-time AS from ASI	578
9.2.6.6	Broadcast received by AS or settlement bank via ICM	579
9.2.6.7	Business information received by AS via ASI	582
9.2.6.8	Information on dedicated amounts received by AS via ASI	582
9.2.6.9	Business information sent by AS via ASI	583
9.2.6.10	Orders sent by AS via ICM	585
9.2.6.11	Orders sent by settlement banks via ICM for connected mechanisms....	586
9.2.6.12	Receipt sent by AS via ASI	586
9.2.7	Use cases for T2S.....	586
9.2.7.1	Liquidity management with T2S DCAs	586
9.2.7.1.1	Push liquidity to T2S	586
9.2.7.1.2	Pull liquidity from T2S	588
9.2.7.1.3	Receive liquidity from T2S	589
9.2.7.1.4	Receive RTGS debit notification	589
9.2.7.2	Request T2S DCA balances via T2	590
9.2.7.3	Interactions for T2S Actors in TARGET2.....	591
9.2.7.3.1	Ask for liquidity transfer status	591
9.2.7.3.2	Revoke a pending liquidity transfer to T2S.....	592
9.2.8	Use cases for TIPS	593
9.2.8.1	Liquidity management with TIPS accounts.....	593
9.2.8.1.1	Push liquidity to TIPS	593
9.2.8.1.2	Pull liquidity from TIPS	594

9.2.8.1.3	Receive liquidity from TIPS	595
9.2.8.1.4	Receive RTGS debit notification	595
9.2.8.2	Request TIPS account balances via T2.....	596
9.3	Internet access related issues	597
9.3.1	Overview	597
9.3.2	Account statement.....	597
9.4	TARGET2 directory	603
9.4.1	Purpose	603
9.4.2	Structure	603
9.4.3	Distribution.....	620
9.4.4	Administration by central banks	623
9.5	Entry check.....	626
9.5.1	Double entry check for PM.....	626
9.5.2	Error codes	629
10	Migration and test procedures	651
	Glossary and Abbreviations.....	653

1 Management Summary

1.1 Introduction

On 24 October 2002, the Governing Council of the ECB took a strategic decision on the direction of the next generation of TARGET - TARGET2. In accordance with this decision, TARGET2 is a multiple platform system based on the principles of:

- Harmonisation
- A single price structure applicable for the core services
- Cost effectiveness
- No competition among its components

In the light of the aforementioned decision of the Governing Council, Banca d' Italia, Banque de France and Deutsche Bundesbank have declared to cooperate on the development of the new payment system TARGET2.

In November 2007, the first group of central banks migrated to the SSP. A complete enumeration of all TARGET2 participants is available on the ECB homepage: <http://www.ecb.europa.eu/paym/t2/html/index.en.html>.

After the full migration, TARGET2 started with 879 direct participants. In average it settles more than 350,000 payments per day which accounts for a total sum of EUR 2.78 trillion on a daily basis. In the first year after going live the technical availability of the SSP reached 99.99%.

This document is based on the idea of having only “one single shared“ platform, that will be operated by the three above-mentioned central banks under the control of all participating central banks including the European Central Bank (ECB).

The User Detailed Functional Specifications (UDFS) document is based on the General Functional Specifications (GFS) approved by the Governing Council.

The next generation of TARGET

Start of the Single Shared Platform (SSP)

User specifications

Content of this document

This document will be updated twice a year and is part of the regular re-release process. The modifications include not only changes of the SSP in the course of the regular November software release of the SSP but also comments by credit institutions, market infrastructures and central banks on the previous version.

This document aims at presenting the UDFS of the core services of the TARGET2 system. It is complemented by a second book dealing with the optional services of TARGET2 and by a third book providing additional information for central banks. The fourth book describes the formats of XML messages and is complemented by the schema files provided in an electronic form. Furthermore, detailed information on ICM screens is provided in the ICM User Handbooks. These books constitute the whole set of UDFS for TARGET2.

This document is structured as follows:

- [Chapter 2 User Guide for Payments Module \(PM\), page 15](#)
User guide for Payments Module presents the user functionality of the Payments Module.
- [Chapter 3 User Guide for Static Data Module \(SD\), page 329](#)
User Guide for Static Data Module presents the user functionality of the Static Data Module which is available to all users.
- [Chapter 4 User Guide for Enhanced Contingency Solution \(ECONS I\), page 345](#)
User Guide for Enhanced Contingency Solution presents the user functionality of the Enhanced Contingency Solution as a high level business continuity tool and the security aspects.
- [Chapter 5 SSP Infrastructure, page 356](#)
SSP infrastructure presents the main characteristics of the IT architecture that will support the services offered by the SSP and of the SWIFT Interface.
- [Chapter 6 Operational model, page 361](#)

This chapter presents the operating times and hours of functioning of the SSP as well as customer contacts and principles of problem management and contingency.

- [Chapter 7 Information and Control Module \(ICM\), page 384](#)
This chapter provides a general overview of the Information and Control Module. Detailed information on the ICM, the related screens and the user roles are provided in a separated document “ICM User Handbook I”.
- [Chapter 8 Enhanced Contingency Solution \(ECONS I\) - User Handbook, page 406](#)
This chapter presents an overview of the operations available on the Enhanced Contingency Solution. Detailed information on the ECONS I functionalities and the related screens are provided in a separate document.
- [Chapter 9 Technical Specifications, page 409](#)
Technical specifications present the use of the SWIFT services, the description of the messages used within the SSP and other technical aspects, eg structure of TARGET2 directory.
- [Chapter 10 Migration and test procedures, page 651](#)
This chapter describes the migration to the SSP and gives general information on the test procedures.

Note: References to time should be read as references to CET/CEST (even if it is not mentioned separately). CEST (Central European Summer Time) is a daylight saving time/summer time zone. It is generally only used during the summer and during the winter CET is used instead.

1.2 Concept of TARGET2

TARGET2 is the real-time gross settlement system of the Eurosystem. It is based on integrated central technical infrastructure called the Single Shared Platform (SSP).

From a user's perspective, TARGET2 offers a broad range of features and services to meet the requirements of the European banking industry, the na-

TARGET2

No phased approach

tional central banks and the ECB. In addition to payment processing the current TARGET2 provides also:

- Most modern liquidity management
- An advanced standard interface for the settlement of ancillary systems
- A dedicated interface for the liquidity management and communication with T2S (T2SI) based on XML messages
- A dedicated interface for the liquidity management and communication with TIPS (TIPSI) based on XML messages
- High resilience and state-of-the-art business continuity

Core and optional services

In order to accommodate the individual needs of banks and infrastructures, TARGET2 offers high flexibility, in particular with regard to liquidity management. Many features like reservation facilities and the use of limits are designed in such way as to allow participating banks or banking communities to decide whether or not they want to use this specific feature.

1.3 Role of central banks (CBs) in TARGET2

Basics

The payment processing in TARGET2 takes place on a centralised technical platform. Nevertheless, the decentralised nature of the relationship between the central banks and their national banking communities has been kept unchanged. Indeed, the principle of a single shared platform enables the central banks to provide improved, harmonised and cost-efficient payment services to their counterparties.

Responsibilities of the central banks

Each central bank remains fully responsible for the business relations vis-à-vis its national TARGET2 participants. Therefore, the system is designed in a "client-based" way in order to meet the administrative and monitoring requirements of the participating CBs.

All features of the system are defined with respect to the level playing field commitment of the Eurosystem. The services offered by the SSP are uniform, irrespective of the national specifics of the CB or the banking community to which they are provided.

Tasks of the central banks

In the context of TARGET2, the central banks have the following responsibilities:

Administrative tasks	Operational tasks
<ul style="list-style-type: none">• All contacts and provision of any kind of support to their participants (credit institutions, ancillary systems)	<ul style="list-style-type: none">• Inclusion and exclusion of participants• Monitoring the activity of their participants• Provision of intraday liquidity necessary for the smooth running of the system• Initiating payments on behalf of their own or on behalf of their participants• Billing to their participants• Handling of local contingency

CBs as participants

Each central bank has also the status of a direct TARGET2 participant. In practical terms, this means that each central bank must be:

- directly addressable in TARGET2 in order to receive payments from other participants
- able to submit payments on its own or on behalf of its customers to TARGET2

1.4 Scope and framework of TARGET2

Specific role of TARGET2

The main objectives of the TARGET2 system can be summarised as follows:

- To serve the needs of the Eurosystem's monetary policy
- To provide a reliable and safe mechanism for the settlement of payments on an RTGS basis

1 Management Summary

1.4 Scope and framework of TARGET2

1.4.1 Overview of core and optional services offered by the SSP

- To increase the efficiency of intra-European payments and to become one of the “core” infrastructures in the envisaged Single Euro Payments Area (SEPA)

Scope of TARGET2

TARGET2 concentrates mainly on payments processing.

In particular, the following aspects should not be considered as part of TARGET2, irrespective of the fact that these activities belong to the common monetary policy of the Eurosystem and, thus, have a close connection to TARGET2:

- Collateral management
- Execution of monetary policy
- Reserve management and standing facilities

Each CB remains fully responsible for the execution of the above-mentioned tasks.

1.4.1 Overview of core and optional services offered by the SSP

A wide range of core and optional services

In order to accommodate the needs of the central banks wishing to use commonly shared resources to a larger extent, the SSP also offers standardised optional modules.

1 Management Summary

1.4 Scope and framework of TARGET2

1.4.1 Overview of core and optional services offered by the SSP

Overview

The following tables give a comprehensive overview of all services offered by the SSP:

Services provided to all users		
Mandatory	Optional	
<ul style="list-style-type: none">• Payments processing in the Payments Module (PM)• Information and Control Module (ICM)• Enhanced Contingency Solution (ECONS I)• Static Data (Management) Module (SD)	<ul style="list-style-type: none">• Liquidity pooling• Limits• Liquidity reservations• Value added services related to the T2 interconnection with T2S	Scope of this book

Services provided to all users subject that the relevant CB has opted for these services		
Mandatory	Optional	
<ul style="list-style-type: none">• Standing Facilities (Module) (SF)• Reserve Management (Module) (RM)	<ul style="list-style-type: none">• Home Accounting Module (HAM)	Scope of Book 2

Note: The fact that a central bank does not opt for one of the services mentioned above does not mean that it will not provide it to its users, but that it will use a proprietary application to provide them instead of using the application provided by the SSP.

1 Management Summary

- 1.4 Scope and framework of TARGET2
- 1.4.1 Overview of core and optional services offered by the SSP

Services provided only to central banks		
Mandatory	Optional	
<ul style="list-style-type: none"> • Monitoring • Mandatory CRSS services (CROSS, storage, archiving, files for billing calculation) • Static Data (specific consultation/updates by the CBs) 	<ul style="list-style-type: none"> • Billing optional services (CRISP) • Query and report optional services (CRAKS1) • Customer relationship optional services (CRAKS3) 	Scope of Book 3

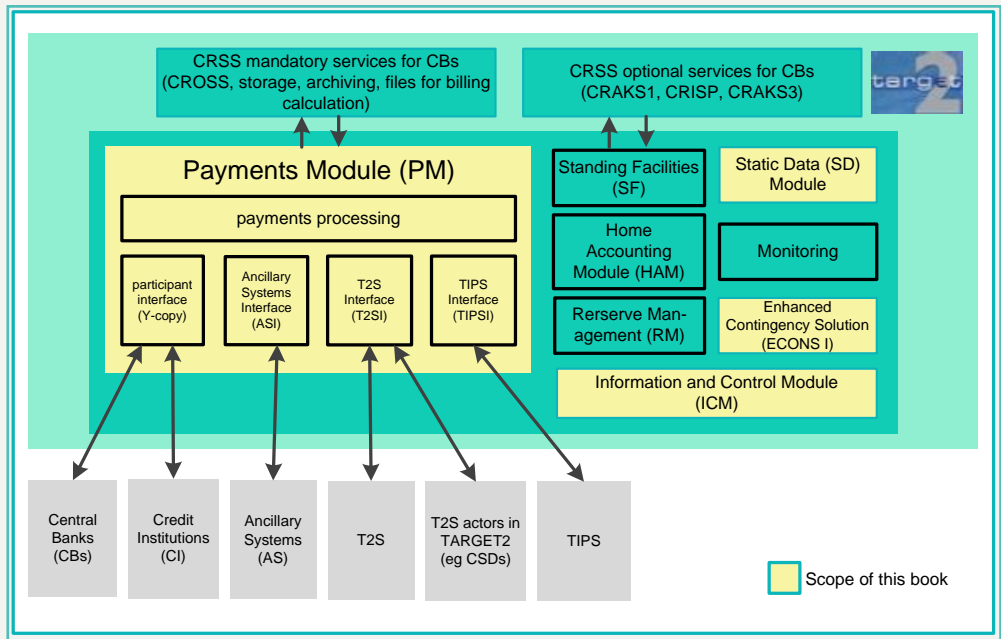

Pricing

The different mandatory and optional services mentioned above are billed according to dedicated pricing schemes. For details please refer to the “User information guide to the TARGET2 pricing” provided on ECB website under <http://www.ecb.europa.eu/paym/t2/professional/fees/html/index.en.html>.

Payments Module

1.4.2 Payments Module (PM)

The Payments Module (PM) integrates all services related to the processing of payments. All direct participants - credit institutions, market infrastructures, other participants and CBs (see chapter [2.1.1 Direct participation, page 16](#) about access criteria) have to maintain an RTGS account managed within the PM. All transactions submitted to and processed by the PM are settled on these RTGS accounts.

In addition to the services related to the processing of payments (settlement including optimisation procedures, queue management, etc.), the PM offers advanced services for liquidity management such as limits, reservation of liquidity, etc. The communication with the participants takes place via four interfaces:

- participant interface (PI) for credit institutions based on the SWIFT FIN Y-copy
- ancillary system interface (ASI) with six generic settlement models based on SWIFTNet XML standards for the ancillary systems business
- T2S interface (T2SI) based on SWIFTNet XML standards offering a broad set of core and optional services for the communication with T2S.
- TIPS interface (TIPSI) based on SWIFTNet XML standards offering a broad set of services for the communication with TIPS.

1.4.3 Information and Control Module (ICM)

The Information and Control Module (ICM) allows participants to access all information related to their accounts and use control measures through a comprehensive online information tool. In particular, the participants benefit from a “single window access” to the Payments Module (PM), Static Data (Management) Module (SD) and depending whether the relevant CB has decided to use optional services, to the Home Accounting Module (HAM), the Reserve Management (Module) (RM) and Standing Facilities (Module) (SF).

Information and Control Module

1 Management Summary

- 1.4 Scope and framework of TARGET2
- 1.4.3 Information and Control Module (ICM)

The ICM enables direct participants to control and manage actively their liquidity and payment flows (visibility of incoming and outgoing payment queue).

The ICM allows access to data of the current business day only.

The ICM can be accessed either through application-to-application (A2A) mode or user-to-application (U2A) mode.

Internet access

In order to meet the needs of smaller banks which are not interested in direct participation via SWIFT, TARGET2 offers an ICM access via Internet in U2A mode. For one given account, however, the ICM U2A access is only possible either via SWIFT or via the Internet.

The Internet-based participants will be able to access via ICM U2A the Payments Module (PM), the Static Data Module (SDM) for information purposes about general static data of participation (eg legal entities, ancillary systems) and SSP data (eg error codes) and to use the functionalities of the Home Accounting Module (HAM), the Standing Facilities (SF) and Reserve Management (RM) Modules, if the respective central banks have opted for these services.

Internet-based participants can be direct PM participants with an RTGS and optional sub-accounts as well as a HAM account (if CB opted for this service). They can be also indirect PM participants (ie no RTGS account) with a HAM account, HAM account holder only (ie banks with only a HAM account but no direct or indirect PM participation) or CB customer (further details in UDFS book 2).

As the communication via Internet is only provided for the ICM U2A access (there is neither a connection to the participant interface nor to the ancillary system interface of the Payments Module), the ICM provides for Internet-based direct PM participants, in addition to the functionalities of a SWIFT-based ICM access, specific screens for the issuing of credit transfer payments (MT 103, MT 103+, MT 202, MT 202 COV, no MT 204).

Note: If differences between the SWIFT and the Internet participation are not explicitly highlighted in the UDFS, the description or the respective functionality is valid for both types of access.

1 Management Summary

1.4 Scope and framework of TARGET2

1.4.4 Reserve Management (RM) and Standing Facilities (SF)

Reserve Management and Standing Facilities

1.4.4 Reserve Management (RM) and Standing Facilities (SF)

With regard to Reserve Management (RM) and Standing Facilities (SF), the choice to adopt standardised SSP modules or to manage them locally is up to the individual central bank. For the local management, specific applications have to be in place at CB level.

Central banks who opt for these standardised SSP modules can offer the following services to their users:

Reserve Management Module (RM)	Standing Facilities Module (SF)
<ul style="list-style-type: none">• Receiving end-of-day balances• Monitoring of the running average in the current reserve period• Calculation and settlement of interest to be paid by the CB for minimum reserves• Calculation and settlement of interest for excess of reserve to be paid by the relevant participants in case of negative rate• Penalties that participants have to pay for non-fulfilment of reserve requirement	<ul style="list-style-type: none">• Management of<ul style="list-style-type: none">– Overnight deposit accounts– Marginal lending accounts• Transfer of liquidity to the overnight deposit account• Granting of overnight credit either<ul style="list-style-type: none">– “on request“ or– automatically, if intraday credit remains at the end-of-day.• Calculation and settlement of interest to be paid by the CB (in case of positive overnight deposit rate) or by the participant (in case of negative overnight deposit rate) and penalties to be paid by the participant (marginal lending facility)• Automatic repayment of the deposit or the overnight credit

1.4.5 Home Accounting Module (HAM)

Direct TARGET2 participants have to maintain an RTGS account in the Payments Module (PM). Nevertheless, each central bank is free to maintain

1 Management Summary

1.4 Scope and framework of TARGET2

1.4.5 Home Accounting Module (HAM)

Need for home accounting

also additional “home accounts“. This “home accounting“ functionality could be used for the following reasons:

- Some banks may not be interested to participate directly in the RTGS system, but are nevertheless subject to minimum reserve requirement. In addition, they may wish to directly manage cash withdrawals etc. Therefore, they need an account with the central bank outside the RTGS system.
- In some cases, depending on the specific situation in each country, it may be preferable to have a second set of accounts. This could be used for specific operations of direct participants which already have an RTGS account.

Each central bank is fully responsible for the execution of its home accounting business. In this context, each central bank is also free to choose:

- Either to offer proprietary home accounting services or to rely only on TARGET2.
- For what type of business the home accounting application is used.

Proprietary Home Accounting (PHA) application

In this case, the service offered to the banks contains a limited number of dedicated transactions, but never fully-fledged payment services.

Home Accounting Module (HAM)

The SSP also offers a standardised Home Accounting Module (HAM).

This module is not intended to offer real payment services. These activities must be performed through a direct PM participant.

The purpose is to accommodate the needs of those central banks wishing to use commonly shared resources to a larger extent. The HAM allows to manage accounts for financial institutions as well as accounts for central bank customers not allowed, according to the TARGET Guideline, to open accounts in the PM (hereafter referred to as “CB customer’s accounts“).

Central banks which opt for the use of this module can offer to their customers the following standardised account services:

1 Management Summary

1.4 Scope and framework of TARGET2

1.4.6 Statistical information

- Liquidity holding (eg maintaining reserve requirement either through RM or proprietary application) on an account with the central bank
- Interbank transfers between accounts in the HAM held by the same central bank
- Interbank transfers between the HAM accounts and RTGS accounts of direct participants
- Cash withdrawals with the respective central bank
- Access to standing facilities either through the SF or through a proprietary application managed by the central bank

There is also the possibility that the HAM account is managed by a PM participant as a co-manager. However, this option is available only for SWIFT-based participants. The aim of the co-management function is to allow small banks to manage directly their reserve requirement but delegate cash flow management to other banks.

The co-management is also available on a cross-border basis.

The HAM is technically integrated in the SSP and can be accessed by customers via SWIFTNet or Internet access.

1.4.6 Statistical information

The Eurosystem provides statistics on the overall TARGET2 activity.

In addition, each central bank can decide to what extent and in which way to offer other statistical information (eg country-related figures, participant-related profiles) to its customers.

CRSS services can support the Eurosystem and CBs in the provisioning of TARGET2 statistics.

1.4.7 The monetary policy execution

TARGET2 is the medium for the smooth conduct of the Eurosystem's monetary policy. The SSP ensures that:

Statistical information

General remarks

1 Management Summary

1.4 Scope and framework of TARGET2

1.4.7 The monetary policy execution

- Technical failures occur as rarely as possible to minimise the related disturbance to the money market.
- The system allows an easy, cheap and secure handling of payments by banks to minimise the recourse to standing facilities and the building up of excess reserves in relation to failures to use the system.
- The flow of liquidity is frictionless and real-time, to support an efficient interbank money market.

Way of executing monetary policy operations

The variety of Eurosystem monetary policy operations is very broad as there are many different procedures - eg a pre-pledged (collateral) pool or repo transactions and different ways for the technical organisation of the collateral management of a CB.

The following table shows some examples in the way in which refinancing operations might be executed:

Activity	Mechanism	Procedure
Liquidity injection	Via repo	<ul style="list-style-type: none">• The CB collateral application/cross-CB payments would initiate a DVP transaction (settlement as ancillary system)
	Via pledge	<ul style="list-style-type: none">• The CB could initiate a standard payment in favour of the participant or increase its credit line
Liquidity withdrawal	Via repo	<ul style="list-style-type: none">• The CB collateral application/cross-CB payments would initiate a DVP transaction (settlement as ancillary system)
	Via pledge	<ul style="list-style-type: none">• The CB could initiate a direct debit or decrease the participant's credit line

CBs which opt for a proprietary home accounting system may opt to execute monetary policy via these accounts.

2 User Guide for Payments Module (PM)

2.1 Participation in and access to TARGET2

General remarks

TARGET2 offers a fair and open access to its services. There are a number of ways to access the TARGET2 system. These include direct and indirect participation, access as correspondent BICs (“addressable BICs”), “multi-addressee access” (“technical BIC access”) and access as T2S actor in TARGET2. More details can be found in the legal documentation.

Different types of access

The following diagram gives an overview of the different types of access from a business point of view.

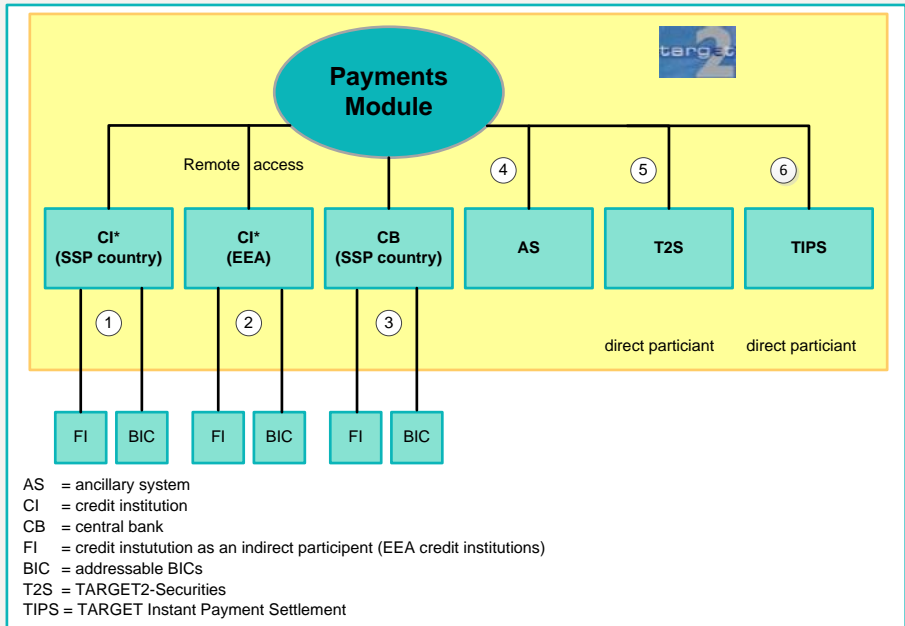

2 User Guide for Payments Module (PM)

2.1 Participation in and access to TARGET2

2.1.1 Direct participation

Number	Explanation
1	CI is a direct participant in the PM. It is located in a country taking part in SSP. The direct participant takes part in the SSP from the country where his home CB is located. Via this participant indirect access is provided to the PM.
2	CI is a direct participant in the PM (remote access participation). It is located in a country of the European Economic Area (EEA). The direct participant takes part in the SSP via a country where his home CB is not located. Via this participant indirect access is provided to the PM.
3	CBs are also direct PM participants.
4	Also ASs may become direct PM participants but the ASI provides a range of services to support AS settlement.
5	TARGET2-Securities is connected via a dedicated interface directly to PM. All liquidity transfers are routed over the T2S transit account in PM.
6	TIPS is connected via a dedicated interface directly to PM. All liquidity transfers are routed over the TIPS transit account in PM.

Mentioning the CBs separately should explicitly point out that also CBs of the ESCB are direct TARGET2 participants.

Note: The diagram does not represent the technical connection to the PM. For multi-addressee access see below.

2.1.1 Direct participation

Characteristics

Direct participants have:

- direct access to the PM
- to hold an RTGS account in the PM
- access to real-time information and control measures

2.1 Participation in and access to TARGET2

2.1.1 Direct participation

They can provide indirect access to the PM for other institutions and offer them additional services. They are responsible for their own liquidity management in the PM and for monitoring the settlement process. Furthermore, they are responsible for all payments sent or received on their account by any entity registered through them in TARGET2 (see chapter [2.1.2 Indirect participation, page 20](#), chapter [2.1.4 Multi-addressee access \(“technical BIC access“\), page 22](#), chapter [2.1.5 Access as correspondent BICs \(“addressable BICs“\), page 24](#) and chapter [2.1.6 Access as T2S Actor in TARGET2, page 24](#)).

For ASs a special interface (Ancillary System Interface) which is also SWIFT-based and integrated in the PM is offered. ASs do not need an own RTGS account depending on the nature of their services. Details about the offered settlement procedures are described in chapter [2.8 Settlement of ancillary systems, page 174](#).

For the provision of liquidity to TARGET2-Securities and vice versa a dedicated interface (T2SI) is built in PM. Liquidity transfers are routed via the T2S transit account in PM. Details about the processing of T2S related liquidity transfers are included in chapter [2.9 Interconnection with TARGET2 Securities, page 260](#).

For the provision of liquidity to TIPS and vice versa a dedicated interface (TIPSI) is built in PM. Liquidity transfers are routed via the TIPS transit account in PM. Details about the processing of TIPS related liquidity transfers are included in chapter [2.10 Interconnection with TIPS, page 302](#).

Access criteria

The basic access criteria for direct participants are as follows:

- supervised credit institutions - as defined in Article 4 (1) of Regulation(EU) No 575/2013, see TARGET2 Guideline and the respective terms and conditions of the national TARGET2 component systems
- treasury departments of member states’ central or regional governments active in money markets
- the public sector - as defined in Article 3 of Council Regulation 3603/93 of 13 December 1993 specifying definitions for the application of the pro-

2.1 Participation in and access to TARGET2

2.1.1 Direct participation

hibitions referred to in Articles 104 and 104 (b) (1) of the Treaty - of member states authorised to hold accounts for customers

- investment firms - as defined in Article 4 (1) (1) of Directive 2004/39/EC of the European Parliament and of the Council of 21 April 2004 on markets in financial instruments amending Council Directives 85/611/EEC and 93/6/EEC and Directive 2000/12/EC and repealing Council Directive 93/22/EEC³ with the exclusion of the entities mentioned in Article 2 (1) of Directive 2004/39/EC, provided that the investment firm in question is entitled to carry out the activities referred to under items 2, 3, 6 and 7 of Section A of Annex I to Directive 2004/39/EC
- organisations providing clearing or settlement services and subject to oversight by a competent authority may be eligible
- central banks (CBs) of the European System of Central Banks (ESCB) and the European Central Bank (ECB) (not separately mentioned in the TARGET Guideline)

In addition to the legal basis mentioned above, direct participants have to fulfil some more technical prerequisites:

- In general, they need a connection to SWIFT's Secure IP Network (such participants are called SWIFT-based participants).
 - directly with an own SWIFT Interface
 - via a SWIFT Service Bureau

Particularly for small and medium size banks it is possible to use an Internet connection (therefore they are also called Internet-based participants) instead of a connection to SWIFT (such participants are called SWIFT-based participants). The Internet connection, however, provides (via ICM) access to the main but not all TARGET2 services.

- In general, they need 8- or 11-digit published SWIFT-BIC to connect to SWIFT's Secure IP Network. It is optional to choose
 - full SWIFT membership
 - limited SWIFT membership (ie: PSPA - Payment system participants)

Limitations and differences of the Internet-based access

- They have to successfully complete a series of tests to prove their technical and operational competence before taking part in the PM.

In case of credit institutions they are able to have “special purpose” accounts for non-payment activity (eg for the maintenance of reserve requirements) in the PM. Upon decision of the respective credit institution, the respective BIC will not be published in the TARGET2 directory, but in the SWIFT BIC directory. In general, an institution (ie one legal entity) can hold several accounts in the PM, each identified via the 8- or 11-digit BIC or - in case of Internet access - also via a not FIN connected BIC.

Internet-based direct participants mainly have access to the same functionalities compared to the SWIFT-based direct participants, but there exist some minor differences and limitations.

A first limitation associated to the Internet-based access is that the ICM is only available in User to Application (U2A) mode and not in Application to Application (A2A) mode.

In addition, not all functionalities will be provided. In particular:

- Payments (MT 103(+), MT 202 (COV)) to any other direct participant (SWIFT- or Internet-based) can only be issued via ICM screens accessed via Internet of the Internet-based participant and not via SWIFT FIN messages.
- Unlike a SWIFT-based participant, incoming payments can only be displayed via the ICM for the Internet-based participant
- MT 204 can be received (including connected payments) but cannot be sent. In case of incoming MT 204 only one sequence B is allowed.
- Based on the general rule, that an Internet-based participant will not receive messages like a SWIFT-based participant, it will also not be possible to receive MT 900/910 or MT 940/950, but account statements with detailed payment information similar to MT 940 will be available for download at the start of the next business day. The account statement will be available at downloading for 10 business days. For further details see chapter [9.3.2 Account statement, page 597](#).

2.1 Participation in and access to TARGET2

2.1.2 Indirect participation

- It will not be possible to use an Internet-based account in a group of account arrangement.
- It will not be possible to use an Internet-based account in a multi-addressee and addressable access arrangement.
- It will not be possible to download the TARGET2 directory, which can be instead consulted only online.
- An Internet-based participant is identified via the 8- or 11-digit BIC (irrespective of its FIN connectivity status).
- An Internet-based participant does not have access to T2S information and cannot initiate standing order or current order liquidity transfers to T2S.
- An Internet-based participant does not have access to TIPS information and cannot initiate standing order or current order liquidity transfers to TIPS.

Note: The limitations and differences are valid for the whole UDFS. They are not always highlighted, eg if a functionality envisages an MT 900/910 confirmation, it is not explicitly mentioned, that this is only valid for SWIFT-based participants as Internet-based participants cannot receive any SWIFT messages.

2.1.2 Indirect participation

Basics

Only supervised credit institutions established in the EEA and EU central banks participating directly in the system are allowed to intermediate for credit institutions in the EEA to have their payment settled without connecting directly to it.

Characteristics

Indirect participants

- are registered in the PM through participants with direct SWIFT-based access (no Internet-based direct participants)
- are directly linked to one direct participant only (that can be located also in another country)

2.1	Participation in and access to TARGET2
2.1.3	Comparison of direct and indirect participation/access

- can be indirectly addressed in the PM
- have no own RTGS account within the PM

Each indirect participant needs a published BIC (8 or 11-digit). It may be a SWIFT-BIC or a non-SWIFT-BIC.

The indirect participant sends payments to/receives payments from the system via the SWIFT-based direct participant. The booking is done on the RTGS account of the direct participant. The relevant direct participant also manages the liquidity for each of its indirect participants, and has accepted to represent the respective participant. The indirect participants will be recognised by the system and as such benefit from the protection of the Settlement Finality Directive (SFD) (in countries where such protection has been granted).

2.1.3 Comparison of direct and indirect participation/access

The table below summarizes the conditions and features of direct and indirect participants:

Feature	Direct participant	Indirect participant
sending and receiving payments	in general (access via SWIFT) <ul style="list-style-type: none"> • directly using an own SWIFT Interface • directly via a service bureau access via Internet <ul style="list-style-type: none"> • via ICM 	via direct SWIFT-based participant
own RTGS account	yes	no
liquidity provisioning	on its RTGS account	by direct participant
liquidity control	by itself	by direct participant

Overview

2 User Guide for Payments Module (PM)

- 2.1 Participation in and access to TARGET2
- 2.1.4 Multi-addressee access (“technical BIC access”)

Feature	Direct participant	Indirect participant
access to ICM	yes	no
addressability	directly	by direct participant
BIC	8 or 11-digit published SWIFT-BIC additionally for access via Internet <ul style="list-style-type: none">• 8 or 11-digit published non-SWIFT-BIC	8 or 11-digit published SWIFT-BIC or non-SWIFT-BIC
publication in BIC/ TARGET2 directory	possible as a direct participant (TGT)	as indirect participant (TG+)

Note: Service bureaus are licensed by SWIFT. Therefore, they have to fulfil the criteria set up by SWIFT. Anyway it is under the responsibility of the di-rect participant when he opts to use a service bureau.

2.1.4 Multi-addressee access (“technical BIC access”)

General remarks

SWIFT-based direct participants (no Internet-based direct participants) are able to authorise their branches and credit institutions belonging to their group located in the EEA countries to channel payments through the RTGS account of the direct participant without its involvement by submitting/receiving payments directly to/from the system.

The payments are settled on the RTGS account of the direct participant.

2 User Guide for Payments Module (PM)

- 2.1 Participation in and access to TARGET2
- 2.1.4 Multi-addressee access (“technical BIC access“)

Comparison

The table below summarizes the conditions and features of direct participants and multi-addressee access:

Feature	Direct participant	Multi-addressee access
sending and receiving payments	<p>in general (access via SWIFT)</p> <ul style="list-style-type: none"> • directly using an own SWIFT Interface • directly via a service bureau <p>access via Internet</p> <ul style="list-style-type: none"> • via ICM 	<ul style="list-style-type: none"> • directly using an own SWIFT Interface • directly via a service bureau
own RTGS account	yes	no
liquidity provisioning	on its RTGS account	by direct participant
liquidity control	by itself	by direct participant
access to ICM	yes	no
addressability	directly	directly
BIC	<p>8 or 11-digit published SWIFT-BIC additionally for access via Internet</p> <ul style="list-style-type: none"> • 8 or 11-digit published non-SWIFT-BIC possible 	8 or 11-digit published SWIFT-BIC
publication in BIC/ TARGET2 directory	as a direct participant (TGT)	as multi-addressee access (TGT)

- 2.1 Participation in and access to TARGET2
- 2.1.5 Access as correspondent BICs (“addressable BICs“)

2.1.5 Access as correspondent BICs (“addressable BICs“)

General remarks

Any correspondent (or branch of a correspondent) of a direct participant (no Internet-based direct participant) that holds a BIC is eligible to be listed in the TARGET2 directory irrespective of its place of establishment. It is the responsibility of the direct participant to forward the relevant information to the respective CB for inclusion in the TARGET2 directory. These BICs can only send and receive payment orders to/from the system via the direct participant. Their payments are settled in the RTGS account of the respective direct participant.

Technically there is no difference between indirect participants and access as a correspondent BICs (“addressable BICs“). However, in legal terms, the addressable BICs will not be recognised by the system and therefore not benefit from the protection of the Settlement Finality Directive (SFD) (in countries where such protection has been granted). Addressable BICs are not relevant for Internet-based participants.

2.1.6 Access as T2S Actor in TARGET2

The access as T2S Actor in TARGET2 is a special type of interaction related to the execution of current order liquidity transfers to T2S. This type of access is mainly granted to Central Security Depository institutions (CSDs) which can initiate on behalf of their customers - TARGET2 direct participants - liquidity transfers to T2S for the settlement of the cash leg of securities transactions.

The T2S Actor in TARGET2 can only access the system via T2SI in application-to-application mode (A2A) using XML messages. Access to ICM is not granted, neither in U2A nor in A2A mode. The DN of the T2S Actor in TARGET2 and its relation to the RTGS account owners for which he is authorised to submit current order liquidity transfers are stored in the matching table DN-BIC in Static Data. The DN of the T2S Actor in TARGET2 cannot be used for other actor types (eg AS or CI).

2 User Guide for Payments Module (PM)

2.1 Participation in and access to TARGET2

2.1.7 Exclusion

In some special cases the access as T2S Actor in TARGET2 can also be granted to other credit institutions that are involved through their customers or branch institutions (direct PM participants) in the processing of current order liquidity transfers to T2S.

2.1.7 Exclusion

2.1.7.1 General aspects

Criteria

The criteria for the exclusion of PM participants are defined outside the UDFS.

Participants that can be excluded

The exclusion of the following participants is described in the following from a business and technical point of view:

- direct PM participants
- ancillary systems

Decision-making body

The CB and/or the banking supervision authority or any other authority in charge declares actions to

- restrain the disposal of the assets
- withdraw the license

As a consequence of this declaration or withdrawal the affected direct PM participant or ancillary system has to be excluded from the business in PM.

The exclusion itself is under the full responsibility of the respective CB (CB where the direct participant is located or the host CB in case of remote access). The CB initiates the exclusion via the ICM.

2.1.7.2 Exclusion of a direct PM participant

Procedure and consequences

When excluding a direct PM participant, it becomes effective in all modules of the SSP at the same time. The procedure in PM is the following:

2.1 Participation in and access to TARGET2

2.1.7 Exclusion

- The RTGS account and the sub-accounts of the direct PM participant are earmarked immediately. As a consequence no payments (debits and credits) can be settled automatically on the RTGS account and the sub-accounts.
- All payments pending in the queue after the exclusion became effective have to be confirmed by the CB before they will be settled on the RTGS account.
- Payments involved in a running settlement process (algorithm) are not affected by the exclusion. The algorithm is not abandoned. If the algorithm
 - is successful, also involved payments of the excluded participant will become final.
 - fails, the payments of the excluded participant will be returned to the queue. They have to be confirmed by the CB before they can be settled in one of the next running algorithms.
- Payments (credit transfers or direct debits) sent by the excluded direct PM participant are stored for confirmation by the CB. If the CB
 - gives its confirmation, the payments will run through the entry disposition. If they cannot be settled in the entry disposition, they will be queued and included in the process of dissolution of the payment queue.
 - disagrees, the payments will be rejected by sending an MT 019 with a unique error code to the excluded direct PM participant.
- Payments (credit transfers or direct debits) sent to the excluded direct PM participant are stored for confirmation by the CB of the excluded direct PM participant. If the CB
 - gives its confirmation, the payments will run through the entry disposition. If the payments cannot be settled in the entry disposition, they will be queued and included in the process of dissolution of the payment queue.
 - disagrees, the payments will be rejected by sending an MT 019 with a unique error code to the sender.

The participants are informed on the exclusion via a broadcast in the ICM.

- Automatic end-of-day liquidity retransfers from the excluded participant to his home account (PHA or HAM) are executed without a manual confirmation by the CB of the excluded participant.
- Automatic end-of-day liquidity retransfers from a participant to another participant, where at least one side is excluded, are not executed and the balance is kept on the sending RTGS account if senders account is not deleted (if senders account is deleted, the end-of-day liquidity retransfer is executed to the CB main account).

Note:

- The confirmation of payments is physically done by the CB of the excluded direct PM participant via ICM. Nevertheless organisational rules outside the SSP can be implemented to involve other bodies (eg the official receiver), but it is up to the legal requirements of each country.
- Independent from the exclusion of a direct PM participant it will be possible to close the account of a PM participant. This closure is a regular process. It becomes effective the next business day or at a predefined business day in the future.

2.1 Participation in and access to TARGET2

2.1.7 Exclusion

Exclusion of group of accounts manager

If the excluded direct PM participant is a group of accounts manager, he will not be able to act as a group of accounts manager from the time the exclusion becomes effective. It is the same for the two variants of group of accounts (“virtual account“ and “consolidated information“ - see chapter [2.5.5 Pooling of liquidity, page 79](#)).

The consequences for the two variants are explained in the following table:

Consequences for ...	
virtual account	consolidated information
<ul style="list-style-type: none"> • The group of accounts is automatically balanced immediately. For this purpose the same procedure is used as for the automatic balancing at the end of the day. After the balancing the account is removed from the group of accounts. It remains outside the group of accounts. Debits and credits in favour of the account of the former group of accounts manager have to be confirmed by the respective CB. • The group of accounts remains consisting of the direct PM participants not being excluded. • Reservations (highly urgent and/or urgent) as well as limits (bilateral and/or multilateral), which are defined at the level of the virtual account, remain in case they were processed before the exclusion of the group of accounts manager. • For the account of the excluded group of accounts manager there are no reservations and no limits in place. • The members of the group of accounts have to nominate a new group of accounts manager from the next business day on. At the end of the business day, no one can balance the RTGS accounts be- 	<ul style="list-style-type: none"> • The account of the excluded group of accounts manager is removed from the group of accounts. Debits and credits in favour of the account of the former group of accounts manager have to be confirmed by his CB. • The group of accounts remains consisting of the direct PM participants not being excluded. • Reservations (highly urgent and/or urgent) as well as limits (bilateral and/or multilateral), which are defined on the level of each single account, remain - also for the account of the excluded member. • The members of the group of accounts have to nominate a new group of accounts manager. If they do not so, there will be no one in place having the global view on all accounts belonging to the group. • It is not possible to make liquidity transfers between the various members of the group via the ICM as long as no (new) group of accounts manager is defined.

2 User Guide for Payments Module (PM)

2.1 Participation in and access to TARGET2

2.1.7 Exclusion

Consequences for ...	
virtual account	consolidated information
<p>longing to the group via the ICM. Therefore an automatic procedure for balancing the accounts runs if necessary.</p> <ul style="list-style-type: none">• It is not possible to change reservations/ limits during the day or to re-order queued payments or to change the levelling out sequence or to make liquidity transfers between the various members of the group via the ICM as long as no (new) group of accounts manager is defined.	

Note: The business case “definition of new group of accounts manager“ is not included in the list of possible intraday updates.

Furthermore, it is also not possible for the respective CB to act on behalf of the virtual group of accounts manager without a defined group of accounts manager.

2.1 Participation in and access to TARGET2

2.1.7 Exclusion

Exclusion of a member of a group of accounts

If the excluded direct PM participant is a member of a group of accounts (“virtual group of accounts” or “consolidated information” - see chapter [2.5.5 Pooling of liquidity, page 79](#)) the exclusion will have the consequences listed in the table below:

Consequences for ...	
virtual account	consolidated information
<ul style="list-style-type: none"> The group of accounts is automatically balanced immediately. For this purpose the same procedure is used as for the automatic balancing at the end of the day. After the balancing the account is removed from the group of accounts. It remains outside the group of accounts. Debits and credits in favour of the account of the former member of the group of accounts have to be confirmed by his CB. The group of accounts remains without the excluded member. Reservations (highly urgent and/or urgent) as well as limits (bilateral and/or multilateral), which are defined at the level of the virtual account, remain. For the RTGS account of the excluded member there are no reservations and no limits in place. 	<ul style="list-style-type: none"> The account of the excluded member of group of accounts is removed from the group of accounts. Debits and credits in favour of the account of the former member of the group of accounts have to be confirmed by his CB. The group of accounts remains without the excluded member. Reservations (highly urgent and/or urgent) as well as limits (bilateral and/or multilateral), which are defined on the level of each single account, remain - also for the account of the excluded member.

Exclusion of co-manager

If the excluded direct PM participant is a co-manager for HAM accounts (see chapter 12.1.3 Account management in book 2), it will not be possible for him anymore to act as co-manager from the time when the exclusion becomes effective.

It is up to the co-managed HAM account holders to nominate a new co-manager. In the meantime their related CB(s) can act for them on request.

2.1 Participation in and access to TARGET2

2.1.8 Directories of the participants

2.1.7.3 Exclusion of an ancillary system (AS)

Procedure

If an AS has to be excluded from the PM it will be treated like a direct PM participant, ie:

- The exclusion becomes effective immediately.
- Transactions can only be settled after a confirmation of the CB of the AS. This will apply to all transactions pertaining to the AS (even if no accounts belonging to this AS are involved, eg in case of XML message debiting a settlement bank and crediting another settlement bank).
- The CB can act on behalf of the AS (eg to send an “end of cycle“ or “end of procedure message“).

2.1.8 Directories of the participants

Directories

Two directories are available to assist the addressing of payments:

- TARGET2 directory
- BIC directory

TARGET2 directory

The TARGET2 directory contains the needed routing information for TARGET2 participants. It is provided electronically in a structured form (see chapter [9.4 TARGET2 directory, page 603](#)). This TARGET2 directory is set up in addition to SWIFT’s BIC directory to support the specific needs of the SSP and its users (provisioning of national sorting code; BIC to be used in SWIFT header for receiver; update rhythm, etc.), and because the BIC directory is currently not able to support these needs.

Updates are based on the content of the up-to-date BIC directory, but take place more often (weekly), whereas the BIC directory is updated on monthly basis.

Note: The information in the TARGET2 directory is not used for the entry-check of incoming messages in the SSP. Therefore, it is possible to address payments to an indirect participant through another direct PM participant not mentioned in relation to this indirect participant in the TARGET2 directory.

BIC directory

Further details on the structure and the delivery of the TARGET2 directory are described in chapter [9.4 TARGET2 directory, page 603](#).

The BIC directory shows all global SWIFT participants and the payment system(s) to which they are connected. For indicating direct and indirect SSP participation worldwide the respective TARGET service code (TGT or TG+) is mentioned for each SSP participant.

SWIFT maintains the BIC directory and makes it available in various formats.

2.2 Accounting

Accounts in the Payments Module (PM)

Each direct TARGET2 participant has to use the PM of the SSP. In order to enable an immediate posting of all payments executed in the PM, each direct participant maintains an account in the PM (so-called RTGS account).

The RTGS account of a direct participant is administered under the sole responsibility of the respective CB (CB where the direct participant is located or the host CB in case of remote access).

Each RTGS account is identified by a “BIC-11” code and unequivocally assigned to one direct participant; if a “BIC-8” code is used, it will be filled up with “XXX”. In case of Internet access RTGS accounts can also be identified by a not FIN connected BIC.

Also AS may hold an account in the PM, if necessary for settlement purposes (eg with regard to the current settlement procedure of the EBA-EURO1 system).

All transactions submitted to and executed in the PM are posted on accounts in the PM.

Home accounting

Participating central banks can settle certain transactions (eg cash operations) outside the PM. In such cases, a “dual accounting” structure has to be available (ie direct TARGET2 participants can have both an account in the PM and in the home accounting environment). This could be:

- a proprietary home accounting system (PHA) of the respective CB

- the standard Home Accounting Module (HAM - offered as optional module of the SSP)

In order to allow for a free and unlimited access to central bank liquidity independent of the specific accounting structure, liquidity transfers can be made between RTGS accounts and home accounts. This functionality is only available for PHA if the respective CB supports the necessary interface to the ICM.

Depending on the accounting structure used by each CB, the liquidity on the RTGS accounts can be maintained:

- intraday and overnight. In this case, the liquidity on the RTGS account at end-of-day could function as “reserve holdings”.
- only intraday. In this case, the liquidity will be transferred back to the home accounts at end-of-day and vice versa before the start of the next SSP business day.

SWIFT-based direct participants in the PM can be informed on the single items booked on and the final balance on their RTGS accounts by a SWIFT message type MT 940 or MT 950.

Statements of RTGS accounts are not available during the day. For intraday liquidity management, the participants are offered a real-time access via the Information and Control Module (ICM). By using an “application-to-application” mode, participants can also integrate the data stream in their internal application.

In case of Internet-based direct participants statements of account formatted similar to MT 940 (see chapter [9.3 Internet access related issues, page 597](#)) can be downloaded as a file for a period of 10 business days.

The following sources of liquidity can be used for the execution of payments:

- balances on RTGS accounts
- provision of intraday liquidity

Overnight holding of liquidity

Statement of RTGS accounts

Sources of liquidity

Intraday liquidity in the SSP

- offsetting payment flows (ie using algorithms to settle a number of queued payments)

Intraday credit can be granted to the single accounts of credit institutions by the respective CB, against eligible collateral.

The following procedures can be used, depending on the decision of the respective CB:

- implementing credit lines on RTGS accounts (based on a pool of pre-deposited collateral)
- implementing credit lines on the proprietary home accounts (ie an additional liquidity transfer between the proprietary home account and the RTGS account is necessary)
- processing of intraday repo transactions

In case of repo transactions, the liquidity will be provided as credit item according to the specific procedure setup by the respective CB. The credit booking may be initiated by the CB or on behalf of the CB by an AS (responsible for the securities settlement).

If the liquidity pooling functionality (virtual account) is used, the liquidity obtained intraday will be available among the group of accounts (see chapter [2.5.5 Pooling of liquidity, page 79](#)).

Credit lines in the PM

If credit lines on RTGS accounts are used by CBs, the liquidity available for processing payments will be the sum of

- the balance on the RTGS account and
- the credit line.

This means that the balance on the RTGS account can enter, up to the respective credit line, into an “overdraft position“. The following table gives a short example:

Action	Balance	Credit line	Available Liquidity (balance + credit line)
Start	1,000	500	1,500
Payment (sent): 800	200	500	700
Payment (sent): 600	-400	500	100
Payment (received): 200	-200	500	300

Update of credit lines

The credit lines in the PM are updated by the respective CB via a standard interface to its collateral management application.

In some cases payments initiated by CBs in favour of a participant can automatically lead to a change of the credit line (eg main refinancing operations in countries with pre-pledged (collateral) pools).

The participant is informed about

- payments with change of credit lines and
- credit line changes initiated via ICM (U2A and A2A)

by an MT 900/910 sent on optional basis.

Furthermore participants can get information about their credit line changes via the ICM (U2A and A2A).

2.3 Liquidity transfer

2.3.1 Liquidity transfer between RTGS and HAM account

2.3 Liquidity transfer

Overview

The PM has its own liquidity holding in central bank money. Liquidity can also be held at home accounts. Therefore, it is possible to transfer liquidity between the different accounts.

Details about liquidity transfer processing related to ancillary systems business is provided in chapter [2.8 Settlement of ancillary systems, page 174](#). The processing of liquidity transfers between TARGET2 and T2S is specified in chapter [2.9.3 Flow of Liquidity Transfers, page 267](#). Information regarding liquidity transfers between TARGET2 and TIPS can be found in [2.10.3 Flow of Liquidity Transfers, page 307](#).

2.3.1 Liquidity transfer between RTGS and HAM account

Technical format of the liquidity transfer request

The ICM liquidity transfer functionality triggers an XML message to be processed either by the PM or HAM. The structure of the XML message is given in book 4 of UDFS.

2.3.1.1 Liquidity injection at the start of the business day

Overview

At the start of the business day, liquidity can be transferred from HAM to the RTGS account in three different ways by

- standing order defined via ICM and automatically executed or
- using the ICM functionality of a manual liquidity transfer or
- submitting a payment via SWIFTNet FIN (when the day trade phase is opened, 7.00)

The start of the new business day is in the evening of the TARGET working day before, details see chapter [6.1 Operating times and operational hours, page 361](#). Liquidity transfers via ICM can be initiated also in the evening (from 19.30 on) or in the morning (after the technical maintenance period) as from 1.00.

2 User Guide for Payments Module (PM)

2.3 Liquidity transfer

2.3.1 Liquidity transfer between RTGS and HAM account

Processing

The following table describes the processing of these liquidity transfers and the consequences if funds are not available in the HAM account:

	Standing order	Manual liquidity transfer	Payment in favour of the RTGS account
Processing time	execution in preparation phase for nighttime settlement, provisioning of liquidity (19.00 - 19.30)	immediately after the submission during operating hours of the ICM	immediately after the submission during the PM operating hours from 7.00 till the cut-off time for interbank payments
Amount	fixed, changes become effective on the following business day	discretionary	discretionary
Priority in PM	n.a.	n.a.	n.a.
Transparency for the direct PM participant	<ul style="list-style-type: none"> in the ICM with a confirmation of credit (MT 910) if requested 	<ul style="list-style-type: none"> in the ICM with a confirmation of credit (MT 910) if requested 	<ul style="list-style-type: none"> in the ICM with a confirmation of credit (MT 910) if requested
Consequences in case of lack of funds in the HAM account	standing order is not executed, manual liquidity transfer necessary	manual liquidity transfer is not executed, new manual liquidity transfer necessary	The payment is not being executed directly but in HAM it is put into the payment queue until sufficient cover is available.

Note: On an optional basis for each transfer of liquidity a confirmation of debit (MT 900) is sent to the CB.

It is also possible to submit liquidity transfers from RTGS account to HAM account after 1.00 (via ICM) and after 7.00 (via a payment).

- 2.3 Liquidity transfer
- 2.3.1 Liquidity transfer between RTGS and HAM account

2.3.1.2 Liquidity transfer during the business day

Overview

During the business day, liquidity can be transferred from HAM to the RTGS account and vice versa at any time. The direct participant can use two different ways to transfer the liquidity:

- ICM functionality of a manual liquidity transfer or
- submitting a payment via SWIFTNet FIN

By using the ICM functionality

A direct PM participant initiates a manual transfer of liquidity between the RTGS account and the HAM account in the ICM during the operating hours till 18.00 or - in case of a prolonged payment processing - till the cut-off time for interbank payments.

After the new business day was started in the evening, it is also possible to initiate liquidity transfers via ICM from the start of night-time processing on (19.30).

Liquidity transfers are possible in both directions (RTGS account to HAM account and vice versa). The direction of the liquidity transfer can be defined in the ICM for each manual transfer.

The following table describes the features of these transfers:

	Liquidity transfer from HAM to RTGS account	Liquidity transfer from RTGS to HAM account
Processing time	immediately after the submission during the PM operating hours till the cut-off time for interbank payments and from the start of night-time processing	immediately after the submission during the PM operating hours till the cut-off time for interbank payments and from the start of night-time processing
Amount	discretionary	discretionary

2 User Guide for Payments Module (PM)

2.3 Liquidity transfer

2.3.1 Liquidity transfer between RTGS and HAM account

	Liquidity transfer from HAM to RTGS account	Liquidity transfer from RTGS to HAM account
Priority in PM	n. a.	urgent
Transparency for the direct PM participant	<ul style="list-style-type: none">• in the ICM• with a confirmation of credit (MT 910) if requested	<ul style="list-style-type: none">• in the ICM• with a confirmation of debit (MT 900) if requested
Consequences in case of lack of funds...	... in the HAM account: Liquidity transfer is not executed, new manual liquidity transfer is necessary.	... in the RTGS account: Liquidity transfer is not executed, new manual liquidity transfer is necessary.

Note: On an optional basis for each liquidity transfer a confirmation of credit (MT 910 - transfer RTGS -> HAM) or a confirmation of debit (MT 900 - transfer HAM -> RTGS) is sent to the CB.

A transfer of liquidity between an RTGS account and a HAM account is initiated by sending a SWIFT message to

- PM to transfer liquidity from the RTGS account to the HAM account
- HAM to transfer liquidity from the HAM account to the RTGS account.

A liquidity transfer is possible from 7.00 till 18.00 or - in case of a prolonged payment processing - till the cut-off time for interbank payments.

By submitting a payment message

2.3 Liquidity transfer

2.3.1 Liquidity transfer between RTGS and HAM account

A liquidity transfer can only be sent for a settlement during the current business day. Warehoused payments are not allowed.

The following table describes the features of these transfers:

	Liquidity transfer from HAM to RTGS account	Liquidity transfer from RTGS to HAM account
Processing time	immediately after the submission during the operating hours of HAM and the PM (from 7.00 till the cut-off time for interbank payments)	immediately after the submission during the operating hours of HAM and the PM (from 7.00 till the cut-off time for interbank payments)
Amount	discretionary	discretionary
Priority in PM	n. a.	urgent/normal
Transparency for the direct PM participant	<ul style="list-style-type: none"> in the ICM with a confirmation of credit (MT 910) if requested 	<ul style="list-style-type: none"> in the ICM with a confirmation of debit (MT 900) if requested
Consequences in case of lack of funds...	... in the HAM account: Liquidity transfer is not executed instantly but being put into the payment queue until sufficient cover is available.	... in the RTGS account: Liquidity transfer is not executed instantly but being put into the payment queue until sufficient cover is available.

Note: On an optional basis for each liquidity transfer a confirmation of credit (MT 910 - transfer RTGS -> HAM) or a confirmation of debit (MT 900 - transfer HAM -> RTGS) is sent to the CB.

2.3 Liquidity transfer

2.3.2 Liquidity transfer between RTGS and proprietary home account (PHA)

2.3.2 Liquidity transfer between RTGS and proprietary home account (PHA)

The ICM liquidity transfer functionality triggers an XML message to be processed either by the PM or PHA. The structure of the XML message is given in book 4 of UDFS.

2.3.2.1 Liquidity supply at the start of the business day

At the start of the business day, liquidity can be transferred from the proprietary home accounting system in three different ways by

- standing order (automatically) or
- using the ICM functionality of a manual liquidity transfer or
- submitting a payment via SWIFTNet FIN (debiting the PHA and crediting the RTGS account, when the day trade phase is opened, 7.00) which has to fulfil certain criteria (MT 202 simplified)

Note:

- The first two possibilities are available only if the respective CB supports the necessary interfaces (first: connection standing order facility in PHA to PM, second: connection PHA to ICM).
- The start of the new business day is in the evening of the TARGET working day before, details see chapter [6.1 Operating times and operational hours, page 361](#). Liquidity transfers via ICM can be initiated also in the evening (from 19.30 on) or in the morning (after the technical maintenance period) as from 1.00.

Technical format of the liquidity transfer request

Overview

2 User Guide for Payments Module (PM)

2.3 Liquidity transfer

2.3.2 Liquidity transfer between RTGS and proprietary home account (PHA)

Processing

The following table describes the processing of these liquidity transfers and the consequences if funds are not available in the proprietary home account:

	Standing order	Manual liquidity transfer	Payment in favour of the RTGS account
Processing time	till 6.45 (or in the evening of the TARGET working day before, during the preparation phase - provision of liquidity, - depends on implementation of each CB).	immediately after the submission during operating hours of the ICM.	immediately after the submission during the operating hours of the proprietary home accounting system and the PM (from 7.00 till the cutoff time for interbank payments in PM).
Amount	fixed, changes become effective on the following business day	discretionary	discretionary
Priority in PM	urgent/normal	urgent	urgent/normal
Transparency for the direct PM participant	<ul style="list-style-type: none"> in the ICM with a confirmation of credit (MT 910) if requested 	<ul style="list-style-type: none"> in the ICM with a confirmation of credit (MT 910) if requested 	<ul style="list-style-type: none"> in the ICM with a confirmation of credit (MT 910) if requested
Consequences in case of lack of funds in the proprietary home account	Liquidity transfer is not executed, new manual liquidity transfer is necessary (rule to be fulfilled by all PHA).	Liquidity transfer is not executed, new manual liquidity transfer is necessary (rule to be fulfilled by all PHA).	The payment is not being executed directly. It depends on the rules of the proprietary accounting system whether the payment is queued or rejected.

2.3 Liquidity transfer

2.3.2 Liquidity transfer between RTGS and proprietary home account (PHA)

The ICM is also available as from 1.00 (after the technical maintenance period). Liquidity transfers between PM and PHA (both directions) can be initiated as soon as the PHA is also available.

2.3.2.2 Liquidity transfer during the business day

A direct PM participant initiates a manual transfer of liquidity between the RTGS account and the proprietary home account in the ICM during the operating hours till 18.00 or - in case of a prolonged payment processing - till the last cut-off time for interbank payments.

After the new business day was started in the evening, it is also possible to initiate liquidity transfers via ICM from the start of night-time processing on (depends on the availability of PHA).

Liquidity transfers are possible in both directions (RTGS account to proprietary home account and vice versa). The direction of the liquidity transfer can be defined in the ICM for each manual transfer.

The following table describes the features of these transfers:

	Liquidity transfer from PHA to RTGS account	Liquidity transfer from RTGS to PHA account
Processing time	immediately after the submission during operating hours of the ICM till the cutoff time for interbank payments in PM and from the start of night-time processing (depends on the availability of PHA)	immediately after the submission during the operating hours of the proprietary home accounting system and the PM till the cut-off time for interbank payments in PM and from the start of night-time processing
Amount	discretionary	discretionary

By using the ICM functionality for a liquidity transfer

2 User Guide for Payments Module (PM)

2.3 Liquidity transfer

2.3.2 Liquidity transfer between RTGS and proprietary home account (PHA)

	Liquidity transfer from PHA to RTGS account	Liquidity transfer from RTGS to PHA account
Priority in PM	urgent	urgent
Transparency for the direct PM participant	<ul style="list-style-type: none">• in the ICM• with a confirmation of credit (MT 910) if requested	<ul style="list-style-type: none">• in the ICM• with a confirmation of debit (MT 900) if requested
Consequences in case of lack of funds...	... in the PHA: Liquidity transfer is not executed, new manual liquidity transfer is necessary (rule to be fulfilled by all PHA).	... in the RTGS account: Liquidity transfer is not executed, new manual liquidity transfer is necessary.

Note: Liquidity transfers from PM to PHA by using the ICM are made via FIN (no Y-copy).

By submitting a payment message

A participant of a proprietary home accounting system initiates a transfer of liquidity between the RTGS account and the proprietary home account by submitting a payment which has to fulfil certain criteria into the respective system - either the proprietary home accounting system or the PM from 7.00 till 18.00 or - in case of a prolonged payment processing - till the cut-off time for interbank payments.

Liquidity transfers are possible in both directions (RTGS account to proprietary home account and vice versa).

The following table describes the features of these transfers:

	Liquidity transfer from PHA to RTGS account	Liquidity transfer from RTGS to PHA account
Processing time	immediately after the submission during the operating hours of the proprietary home accounting system and the PM (from 7.00 till the cut-off time for interbank payments in PM)	immediately after the submission during the operating hours of the proprietary home accounting system and the PM (from 7.00 till the cut-off time for interbank payments in PM)
Amount	discretionary	discretionary
Priority in PM	urgent/normal	urgent/normal
Transparency for the direct PM participant	<ul style="list-style-type: none">• in the ICM• with a confirmation of credit (MT 910) if requested	<ul style="list-style-type: none">• in the ICM• with a confirmation of debit (MT 900) if requested
Consequences in case of lack of funds...	... it depends on the rules of the proprietary accounting system whether the liquidity transfer is queued or cancelled.	... in the RTGS account: Liquidity transfer is not executed instantly but being put into the payment queue until sufficient cover is available.

2.3.3 Retransfer of liquidity at the end of the business day

A CB has to decide whether the liquidity of its direct participants is kept

- in the PM or

2.3 Liquidity transfer

2.3.3 Retransfer of liquidity at the end of the business day

- in the HAM or
- in a proprietary home accounting system

during the night.

If the CB opts for the first alternative, it is also possible not to keep the liquidity on participant's RTGS account but to transfer the remaining positive balance (or negative balance if a credit line is used) to another direct participant of the same banking community.

If the CB opts for the second or third alternative, the remaining positive balance (or negative balance if a credit line is used - MT 202 "negative") on each RTGS account will be transferred automatically to a specified (pre-defined) account in

- the HAM (only transfer of credit position) or
- a proprietary home accounting system

at the end of the business day.

The following rules apply for participants with negative balance (which decided to transfer the liquidity to another participant or to a PHA CB) at end of day:

- The negative liquidity transfer will only be executed, if the liquidity on receiver's account (= debtor) is sufficient.
- In case of lack of liquidity the negative liquidity transfer will not be processed, ie no partial execution.

If an RTGS account without a liquidity removal address in the static data is deleted the remaining balance on the closed RTGS account is transferred to the CB main account of the responsible CB. No notifications MT 900/910 are created in this exceptional case. An alert broadcast for the Operational Team and the CB account statement MT 940/950 for the responsible CB are provided as information source for further treatment by the OT/CB.

2.3 Liquidity transfer

2.3.3 Retransfer of liquidity at the end of the business day

In case of exclusion of a participant special rules apply for the retransfer at end of day (see chapter [2.1.7.2 Exclusion of a direct PM participant, page 25](#)).

If the participation type is switched from SWIFT-based to Internet-based participant or vice versa without modification of RTGS account number the liquidity will be kept on this account when no liquidity removal address has been defined.

The following tables describe the different retransfers of liquidity:

Retransfer of liquidity from an RTGS account in favour of a specified HAM account at the end of the business day	
Processing time	after processing of SF transactions
Amount	the credit position of the RTGS account
Priority in PM	Highly urgent
Transparency for the direct participant	<ul style="list-style-type: none">• in the ICM• with a confirmation of debit (MT 900) if requested• on the statement of<ul style="list-style-type: none">– the RTGS account and– the HAM account

Note: On an optional basis for each re-transfer of liquidity a confirmation of credit (MT 910) is sent to the central bank.

Processing

2.3 Liquidity transfer

2.3.3 Retransfer of liquidity at the end of the business day

Retransfer of liquidity from an RTGS account in favour of a specified PHA account at the end of the business day	
Processing time	before 18.30 (the retransfer will take place after levelling out the group of accounts - end of day emergency procedure if necessary)
Amount	the credit or debit position of the RTGS account
Priority in PM	Highly urgent
Transparency for the direct participant	<ul style="list-style-type: none"> • in the ICM • if requested: with a confirmation of debit (MT 900) in case of a positive balance and a confirmation of credit (MT 910) in case of a negative balance on the RTGS account • on the statement of <ul style="list-style-type: none"> – the RTGS account and – the proprietary home account

Note: Liquidity transfers from PM to PHA at the end of the day are made via FIN (no Y-copy).

Retransfer of liquidity: remote access participant

Remote access participants without a HAM account or a proprietary home account who are not allowed to keep their liquidity on their own RTGS account have to specify the RTGS account of another participant at the hosting CB as the destination for the retransfer of liquidity at the end of the business day.

The following table describes this PM internal retransfer of liquidity:

Retransfer of liquidity from the RTGS account of a remote access participant in favour of a specified other RTGS account at the end of the business day	
Processing time	immediately prior to the retransfer of liquidity to the HAM or proprietary home accounts
Amount	the credit position of the RTGS account

Retransfer of liquidity from the RTGS account of a remote access participant in favour of a specified other RTGS account at the end of the business day	
Priority in PM	Highly urgent
Transparency for the direct participant without a HAM or proprietary home account	<ul style="list-style-type: none">• in the ICM• with a confirmation of debit (MT 900) if requested• on the statement of the RTGS account
Transparency for the receiving direct participant	<ul style="list-style-type: none">• in the ICM• on the statement of the RTGS account• with a confirmation of credit (MT 910) if requested

2.4 Payment types

2.4.1 General overview

Basics

TARGET2 offers to the participants settlement services in euro.

For the following payments and subject to further discussion, the use of TARGET2 will remain mandatory:

- monetary policy operations (in which the Eurosystem is involved either on the recipient or on the sender side)
- settlement of the euro leg of foreign exchange operations involving the Eurosystem
- settlement of cross-border large value netting systems handling euro transfers.

In general it seems preferable that in future all systemically important payment systems will have to settle in TARGET2.

Any euro payment which participants wish to process in real-time and in central bank money can be executed in TARGET2.

Payments types

PM participants can submit/issue the following payment types:

- credit transfers: MT 103, MT 103+, MT 202 and MT 202 COV
- direct debits: MT 204 (only for SWIFT-based PM participants; an Internet-based participant can only receive a MT 204)

The following table shows the possible SWIFTNet FIN message types processed by the PM:

Message Type	Acceptance	Description
MT 103	Mandatory	Customer payment
MT 103+	Mandatory	Customer payment (STP)
MT 202	Mandatory	Bank-to-bank payment
MT 202 COV	Mandatory	Bank-to-bank payment with customer credit transfer details
MT 204	Optional	Direct debit payment
MT 011	Optional	Delivery notification
MT 012	Optional	Sender notification
MT 019	Mandatory	Abort notification
MT 900	Optional	Confirmation of debit
MT 910	Optional	Confirmation of credit
MT 940/950	Optional	(Customer) Statement message

Note: MT 011 is provided by SWIFT on an optional basis. Also MT 012 and MT 019 are SWIFT system messages.

With registration each direct participant has to declare which optional message types will be accepted.

For message structure and field specification see chapter [9.1 SWIFTNet FIN related issues, page 409](#).

Domestic specialities regarding field contents to be validated at system level are not available. This does, of course, not exclude PM participants agreeing bilaterally or multilaterally on specific rules regarding the field contents. It is not checked by the SSP whether the respective PM participants comply with these rules.

In general, payments are settled immediately, if sufficient liquidity is available on the RTGS account of the participant.

To settle payments in the PM in a different way, considering their urgency, they can be submitted by the sender either using:

- priority class 0 (highly urgent payments)
- priority class 1 (urgent payments)
- priority class 2 (normal payments)

All priority classes have specific characteristics. Some of the priority classes can only be used by certain groups of PM participants. Within a priority class no further prioritisation is possible (no sub-priorities). That means “highly urgent payments“ are settled following the principles of entry disposition and execution of offsetting transactions (see chapter [2.7.1.2 Settlement of payments in the entry disposition, page 144](#)).

Priority of payments

Rules

- If no priority class is selected, payments will be handled as normal payments (priority class 2).
- The priority class 0 (highly urgent payments) is only available for ancillary systems settlement transactions (payments from the AS through a specific interface for AS as well as direct PM participants' liquidity transfer to AS), CB transactions (eg cash withdrawals) and direct participants' CLS payments.
- Some specific CB transactions, which are not a payment (eg decrease/increase of credit lines), are treated preferential to priority class 0. Hence highly urgent reservation will be influenced directly by a decrease of credit line.

2.4.2 Comparison of different payment types

According to the priority of payments they can be classified as follows:

Classification

	Highly urgent	Urgent	Normal
Class of priority	0	1	2
Submission by...	<ul style="list-style-type: none"> Ancillary systems (AS) through ASI CBs Direct PM participants for liquidity transfers to AS, T2S and TIPS Direct PM participants (CLS payments) T2S Actors in TARGET2 for liquidity transfers to T2S 	<ul style="list-style-type: none"> AS CBs Direct PM participants 	<ul style="list-style-type: none"> AS CBs Direct PM participants
Characteristic	<ul style="list-style-type: none"> Settlement of transactions/ group of transactions between participants of an AS Posting central bank transactions (eg cash withdrawals) CLS pay-ins and pay-outs All T2S and TIPS related liquidity transfers 	<ul style="list-style-type: none"> Priority payments Gross processing due to extensive and fast consideration of bilateral payment flow 	<ul style="list-style-type: none"> Highly liquidity saving due to extensive consideration of mutual payment flow Claim of real-time processing takes second place to liquidity saving processing

2.4 Payment types

2.4.2 Comparison of different payment types

Specific procedures for ancillary systems

For change of payment types (priority) see chapter [2.7.2 Comprehensive queue management, page 150](#).

AS can use specific procedures for the efficient settlement of their business. By means of the Ancillary System Interface (ASI), an ancillary system's manager can initiate:

- debits of its own account against credits of the settlement bank's accounts (transactions similar to credit transfer payments)
- debits of the settlement bank's accounts against credits of its own account (transactions similar to direct debit payments)
- debits of the settlement bank's accounts against credits of other settlement banks (transactions similar to mandated payments)

The ASI and the procedures of settlement are described in chapter [2.8 Settlement of ancillary systems, page 174](#).

Direct debit functionality

Direct debits in TARGET2 are intended for wholesale purposes only and are restricted to interbank transactions.

The direct debit functionality, which is only available between participants in the PM, can be used by:

- CIs
- CBs
- AS

In particular, it might be used to offer an efficient cash management service within a group of credit institutions or between different branches of a CI.

Direct debits used by credit institutions

In any case, the respective participants have to agree with the parties allowing debiting their accounts on the terms and conditions for using this service. TARGET2 offers only the general framework.

The participant authorises another participant to issue a direct debit order. He also has to inform his CB, which is responsible to record and administrate the pre-agreements in the Static Data (Management) Module via ICM.

The following parameters are used in connection with the direct debit scheme:

- Mandatory
 - Direct debit issuer
 - Account to be debited
 - Reference
- Optional
 - Maximum amount per day (for all direct debits independent from the counterparty)
 - Maximum amount per counterparty
 - Maximum amount of any single payment per counterparty

The PM ensures, that the conditions mentioned above (if chosen) are met before processing a direct debit request.

Direct debits used by CBs

The direct debit facility can also be used by central banks. The following transactions are examples of the usage:

- settlement of cash withdrawals
- repayment of monetary policy operations
- collections of fees

Mandated payments used by CBs

The mandated payment facility can be used by central banks in case of contingency situations at the level of the direct participant. In this situation, the CB can send a credit transfer (with specific message structure) on behalf of the failed direct participant. This facility is also provided on behalf of an Internet-based direct PM participant.

2.4.3 Definition of execution time

Payments with a set execution time

PM participants have also the possibility to determine the settlement time of their transactions. The following options are available:

2 User Guide for Payments Module (PM)

2.4 Payment types

2.4.3 Definition of execution time

- transactions with an “Earliest Debit Time Indicator“
- transactions with a “Latest Debit Time Indicator“

The following table describes payments with a set execution time.

	Earliest Debit Time Indicator	Latest Debit Time Indicator
Features	Transactions to be executed from a certain time (codeword: /FROTIME/)	<ul style="list-style-type: none">• Option a: transactions to be executed up to a certain time (codeword: /REJTIME/)• Option b: transactions which should be executed up to certain time (only warning indicator) (codeword: /TILTIME/)
Effect	<ul style="list-style-type: none">• Transaction is stored until the indicated time.• At the earliest debit time, the transaction runs through the entry disposition.	<ul style="list-style-type: none">• Setting the execution time only means a special identification via the ICM.• The transaction is treated like any other payment of this type.
Management	If the transaction cannot be settled at the earliest debit time, it will be queued till cut-off time for payment type is reached (or revoked).	If the transaction cannot be settled until the indicated debit time, <ul style="list-style-type: none">• Option a: The payment will be rejected.• Option b: The payment will remain in the queue.

In case a payment with a “Latest Debit Time Indicator“ is not executed 15 minutes prior to the defined time, an automatic notification in the ICM will be triggered. The broadcast will be directly displayed on top of all screens of the participant whose account will be debited.

Note: In case the codeword /CLSTIME/ is used (Field 72), the payment will be treated in the same way as a payment with a “Latest Debit Time Indicator“, option b.

It is possible to combine the “Earliest Debit Time Indicator“ with the “Latest Debit Time Indicator“ (option a + b). In case of option a, the transaction is meant to be executed during the indicated period.

The defined execution time of a payment can be changed if the payment is not executed yet. Effect of changing settlement time see chapter [2.7.2 Comprehensive queue management, page 150](#).

Note:

- It is no longer possible to change the “Earliest Debit Time Indicator“ of a payment which is queued due to the fact that the original “Earliest Debit Time Indicator“ has been reached and it was already tried to settle this payment.
- A time indication for a MT 202 introducing a pull Liquidity Credit Transfer from T2S is not allowed due to technical restrictions.

2.4.4 Warehouse functionality

Basics

It is possible to submit payments up to five TARGET working days in advance. In this case, the payment message is warehoused until TARGET2 opens for that date.

Note: In case a change in SWIFT standards or formats is performed warehoused payments with an execution time beyond this point in time cannot be stored in the SSP. This will be technically ensured by the SSP.

Rules

The validation of warehoused payments is a three layer approach:

- SWIFT format checks on the day of submission
- format checks by SSP already on the day of submission
- content check (eg valid receiver BIC) on the value day

No checks are made by SSP in the time between.

Processing on value day

On the value date with the start of the day trade phase (7.00) the warehoused payments are processed by PM (with entry timestamp 7.00) on top

Information and control functions

of the queue of incoming payments which have the same priority. They will be immediately settled if enough liquidity is available (normal processing of payments in the entry disposition, see chapter [2.7.1 Entry disposition, page 142](#)). Otherwise they are queued until the settlement attempt is successful (see chapter [2.7.3 Dissolution of payment queue, page 155](#)).

Exception: Warehoused payments with an Earliest Debit Time Indicator are queued until the set execution time is reached.

Warehoused payments benefit from the same functionality via ICM as queued payments:

- transparency about the status and other detailed information about the payment
- cancellation
- change of priority
- change of execution time (Earliest and Latest Debit Time Indicator) if set in the warehoused payment

2.4.5 Backup payments

In case of a technical system outage a SWIFT-based direct PM participant (affected participant) may lose its ability to send payments to and receive payments from TARGET2.

Such a breakdown may result in:

1. pay-in obligations in other systems (eg CLS) not met;
2. liquidity being built up in the affected participant's RTGS account, if other TARGET2 participants did already submit or continue to submit payments in favour of the affected participant.

In order to give the affected participant a possibility to reduce the business impact of the technical failure, the SSP offers a functionality to generate payments via the ICM, the so-called backup payments functionality. The usage is optional and the functionality is blocked by default. It can only be

used once the National Service Desk on request of the affected participant has authorised this.

Two categories of backup payments exist:

1. the backup contingency payments to predefined systems (CLS and EURO1);
2. the more flexible backup liquidity redistribution payments to other direct TARGET2 participants.

The backup functionality via ICM is not available for Internet-based participants. However, in case of contingency the responsible CB can connect to the ICM and submit payments on behalf of the Internet-based participant.

2.4.5.1 Backup contingency payments

Backup contingency payments are intended to meet obligations and demands arising from the settlement and funding process of systems, for which templates are predefined in the system (CLS pay-ins, payments to the EURO1 collateral account, pay-ins to the EURO1 prefunding account related to the liquidity bridge between TARGET2 and EURO1).

The table below gives the rules for backup contingency payments to CLS:

Type of payment	<ul style="list-style-type: none"> • Highly urgent payment
Generation	via the ICM
SWIFT message type	MT 202 via SWIFTNet FIN (no Y-copy)
Sender of this message	TRGTXEPMXXX (PM BIC)
Receiver of this message	CLS BIC
Fields for input via ICM	<ul style="list-style-type: none"> • Field 21: Related reference • Field 32A: Amount • Field 52A: BIC of the ordering institution • Field 58A: BIC of the receiver in CLS (ordering party)

Objective

Rules for CLS payments

2 User Guide for Payments Module (PM)

- 2.4 Payment types
- 2.4.5 Backup payments

	<ul style="list-style-type: none"> • Field 72: "/CLSTIME/" followed optionally by timestamp (hhmm); this time is treated as latest debit time
Fields predefined (cannot be changed)	Field 20: TRN assigned by PM
Tag in the payment message	/BUP/, will be automatically added to field 72 (BUP = backup payment)
Tag in the statement message	BUP
Tag in the ICM payment queue	Backup Payment

Rules for backup contingency payments to EURO1 collateral account

The table below gives the rules for backup contingency payments to the EBA related to EURO1 collateral account:

Type of payment	Urgent payment
Generation	via the ICM
SWIFT message type	MT 202 via SWIFTNet FIN (no Y-copy)
Sender of this message	TRGTXEPMXXX (PM BIC)
Receiver of this message	EBA BIC (collateral account)
Fields for input via ICM	<ul style="list-style-type: none"> • Field 21: Related reference • Field 32A: Amount • Field 52A: BIC of the ordering institution
Fields predefined (cannot be changed)	<ul style="list-style-type: none"> • Field 20: TRN assigned by PM • Field 58A: EBA BIC (collateral account)
Tag in the payment message	/BUP/, will be automatically added to field 72 (BUP = backup payment)
Tag in the statement message	BUP
Payment type in the ICM payment queue	Backup Payment

Rules for backup contingency payments to EURO1 pre-settlement account (liquidity bridge)

The table below gives the rules for backup contingency payments to the EURO1 pre-settlement account (liquidity bridge between TARGET2 and EURO1):

Type of payment	Urgent payment
Generation	via the ICM
SWIFT message type	MT 202 via SWIFTNet FIN (no Y-copy)
Sender of this message	TRGTXEPMXXX (PM BIC)
Receiver of this message	EBA BIC (pre-settlement account)
Fields for input via ICM	<ul style="list-style-type: none">Field 21: Related referenceField 32A: AmountField 52A: BIC of the ordering institution
Fields predefined (cannot be changed)	<ul style="list-style-type: none">Field 20: TRN assigned by PMField 58A: EBA BIC (pre-settlement account)
Tag in the payment message	/BUP/, will be automatically added to field 72 (BUP = backup payment)
Tag in the statement message	BUP
Payment type in the ICM payment queue	Backup Payment

2.4.5.2 Backup liquidity redistribution payments

Objective

Backup liquidity redistribution payments are intended to redistribute excess liquidity accumulated on the RTGS account of the affected participant. It aims to mitigate the possibility of a shortage of liquidity within the TARGET2 system.

As the recipient can be any direct TARGET2 participant, they can be used also for meeting obligations and demands arising from the settlement and

2 User Guide for Payments Module (PM)

- 2.4 Payment types
- 2.4.5 Backup payments

Rules for backup liquidity redistribution payments

funding processes for other systems than those explicitly covered by the backup contingency payments as described above.

The table below gives the rules for backup liquidity redistribution payments:

Redistributing liquidity payments can be transferred to...	direct PM participants (including CBs as direct PM participants)
Generation	via the ICM
Type of payment	urgent payment
SWIFT message type	MT 202 via SWIFTNet FIN (no Y-copy)
Sender of this message	TRGTXEPMXXX (PM BIC)
Receiver of this message	According to BIC input in field 58A
Fields for input via ICM	<ul style="list-style-type: none">• Field 32A: Amount• Field 58A: BIC of the receiver of the payment
Fields predefined (cannot be changed)	<ul style="list-style-type: none">• Field 20: TRN assigned by PM• Field 21: same content as field 20• Field 52A: BIC of the ordering institution
Tag in the payment message	/BUP/, will be automatically added to field 72 (BUP = backup payment)
Tag in the statement message	BUP
Tag in the ICM payment queue	Backup Payment

2.5 Liquidity management

Business case

A direct participant in the PM has the option to control the use of the supplied liquidity by means of a reservation and limit system which could be combined with each other according to its individual needs. In case no limit or reserve is defined, the participant's liquidity is available for each payment. Additionally, a functionality of "setting aside" liquidity ("dedicated liquidity") for AS settlement can be used.

Note: In case of a virtual group of accounts limits and reservations can only be defined for a whole group and not for a single RTGS account which is member of a group of accounts (see chapter [2.5.5.1 Description and possible options](#), page 79).

2.5.1 Reservation facilities

Types of reserves

PM offers two different types of reserves:

- Highly urgent reserve
- Urgent reserve

2.5.1.1 Highly urgent reserve

Highly urgent reserve

With the usage of the highly urgent reservation facility liquidity can be reserved for the execution of highly urgent transactions (priority class 0).

2.5.1.2 Urgent reserve

Urgent reserve

With the usage of the urgent reservation facility liquidity can be reserved for the execution of urgent and highly urgent transactions (priority class 1 and 0).

2.5.1.3 Rules for definition of reserves

The reservation process consists of the following steps:

Step	Explanation
1	The direct PM participant defines the amount being reserved as highly urgent and/or urgent reserve.
2	The direct PM participant marks those payments which should have access to the reserved liquidity by determining the appropriate priority.

Reservation process

Setting and changing of reservations

Reservation can be effected by direct PM participants using the ICM. Direct PM participants have the possibility to

- “reset“ to zero the liquidity reserved.
- change the amount on demand during the day with immediate effect (eg from 200 to 300).
- establish a specific amount during the current day with immediate effect (eg setting a new reservation of 300).
- input a default amount for the following day(s) (valid until next change).
- The definition of standing order reservation is only possible for credit based only RTGS accounts (also if participating as CB).

Time of changing

The default amount will be valid at start-of-day even if the amount of the reservation is changed during the preceding day with immediate effect (such a change is only valid for that day).

Initiator of reservation

To ensure that PM participants maintain full control of their liquidity management, only credit-based RTGS account holders are generally allowed to reserve liquidity. (Rules for reservation of a group of accounts - option: virtual account see chapter [2.5.5 Pooling of liquidity, page 79](#))

In contingency situations (eg technical problem faced by a credit institution) it is possible that participants can request their CB to act on their behalf.

2 User Guide for Payments Module (PM)

2.5 Liquidity management

2.5.1 Reservation facilities

(Un)successful reservation

After receipt of the reservation request the system checks, whether the amount of liquidity on the direct PM participant's RTGS account is sufficient for the reservation.

Enough liquidity available	Not enough liquidity available
Requested amount is reserved	<ul style="list-style-type: none">• Liquidity available on the account is reserved.• The participant will be notified by a broadcast via the ICM that the total amount could not be reserved.• The remaining reservation request will be queued and processed in an event oriented way.• In case of an increase of the available liquidity an asynchronous resolving process attempts to process the pending reservation order.• Even if the increase of available liquidity is not sufficient for the complete processing the pending reservation will be processed partly (the pending reservation is decreased and the existing reservation is increased).• New reservation requests related to the direct PM participant's RTGS account replace pending reservation requests (also applicable for revocation purposes). <p>Note: Due to the asynchronous processing incoming liquidity might be blocked and used by a parallel booking process before the attempt to increase the reservation has been performed.</p>

Types and characteristics of limits

Objectives for the use of limits

Bilateral position

Effect of bilateral limit

2.5.2 Use of limits

In general, limits determine the payment amount (priority = normal) a participant is willing to pay to another participant (bilateral) or to the other participants (multilateral - towards which no bilateral limit is defined), without having received payments (that are credits) first.

It is possible to set the following types of limits in the PM:

- Bilateral limit
- Multilateral limit

The limits are debit limits and not credit limits.

The setting of these limits enables the direct PM participant:

- to prevent unbalanced dissipation of liquidity with regard to other direct PM participants.
- to avoid free-riding on the liquidity of a direct PM participant by another participant.
- to synchronise the payment flow with other direct PM participants and to promote its early submission.

Note: Limits cannot be defined among direct PM participants belonging to the same group of accounts (option: virtual account). In case of grouping of accounts (virtual accounts) limits are only available at the level of the group of accounts (see chapter [2.5.5 Pooling of liquidity, page 79](#)).

2.5.2.1 Bilateral limits

The bilateral position from Bank A towards Bank B is defined as the sum of payments received from Bank B (credits for Bank A), minus the sum of payments made to Bank B (debits for Bank A). This means if the result is negative, the bilateral limit will be utilised with this amount.

With the bilateral limit, the direct PM participant restricts the use of liquidity when submitting normal payments for another direct PM participant.

Multilateral position

2.5.2.2 Multilateral limit

The multilateral position from Bank A is defined as the sum of payments (credits for Bank A) received from all direct PM participants towards which no bilateral limit has been defined, minus the sum of payments (debits for Bank A) made to these direct PM participants. This means if the result is negative, the multilateral limit is utilised with this amount.

Effect of multilateral limit

With the multilateral limit, the direct PM participant restricts the use of liquidity, when submitting normal payments for any other direct PM participant for which a bilateral limit has not been set. A multilateral limit can be defined if at least one bilateral limit exists.

Limitation process

2.5.2.3 Rules for definition of limits

The limitation process consists of the following elements:

- Definition of bilateral limits towards selected direct PM participants with account type “normal” (ie not account type “AS guarantee account”)
- Definition of a multilateral limit towards all direct PM participants towards whom no bilateral limit is defined

A normal payment will only be settled if it does not cause the bilateral or multilateral position to go beyond the bilateral or multilateral limit.

Note:

- Setting limits is only possible vis-à-vis RTGS account holders (in case of a group of accounts: only possible vis-à-vis the virtual account) in the SSP.
- It is not possible to use limits vis-à-vis participating CBs.
- It is not possible to define limits if participating as CB.
- A bilateral or multilateral limit with an amount of zero is a limit which is not defined.

2 User Guide for Payments Module (PM)

2.5 Liquidity management

2.5.2 Use of limits

- Incoming urgent payments from a participant towards whom a bilateral/multilateral limit is defined also effect the bilateral/multilateral position.

To take a limit (bilateral or multilateral) into account during the settlement process, it has to be defined before the end of the previous business day. This means that an amount above zero has to be defined before the end of the business day before, but once a limit is defined, it can be changed as described in the table below.

The options for setting and changing limits via ICM are as follows:

Setting and changing of limits

Activity	Explanation
Set limits	They can be set with effect from the next business day until further notice. The minimum limit amount is one million euro.
Change limits	<p>They can be increased or decreased and reduced to zero</p> <ul style="list-style-type: none">• with immediate effect for the current day• for future business days with effect from the next business day at any time during the day. <p>If a limit is once reset to zero, it will not be possible to increase it again on the same business day. On this day the consequence is, that during the settlement of normal payments it is not checked any more whether or not the respective limit is breached.</p> <p>Eg bilateral limit against participant B = 0: Payments in favour of participant B are only checked against the multilateral limit position.</p>

Initiator of limit setting and changing

Limits are exclusively set by direct PM participants.

Only in the case of a technical problem on the direct PM participant's site, the CB can be authorised by him to adjust the amount of a limit with impact to the next algorithm.

For this purpose the CB has to receive an instruction or agreement from the CI in advance.

2.5	Liquidity management
2.5.3	Dedicated liquidity for AS settlement

2.5.3 Dedicated liquidity for AS settlement

Purpose of dedicated liquidity

For the settlement of an AS, especially night-time processing but also settlement of AS and during the day, the direct PM participant can “set aside” liquidity (“dedicated liquidity”) for this purpose only. This is effective by maintaining a specific RTGS sub-account in case of the interfaced model. In case the main RTGS account of the direct PM participant belongs to a virtual group of accounts, the linked RTGS sub-account is not included in this virtual group of accounts because the balance on this RTGS sub-account corresponds to funds available to settle particular AS operation(s) (Details see chapter [2.8 Settlement of ancillary systems, page 174](#)). In case of the real-time model where the settlement occurs within the AS itself, the pertinent AS has to use a so-called technical account - procedure 6 real-time to collect the liquidity set aside by its settlement banks and to transfer it in the cash position within its own system.

Process of setting aside liquidity

There are different possibilities for a direct participant to transfer liquidity to his sub-account(s) or to a technical account - procedure 6 real-time:

- Standing order liquidity transfer via the ICM
- Current order liquidity transfer via ICM
- Normal payment message (only for SWIFT-based participants)

Time of changing the standing order

The default amount is always valid at start-of-day. Therefore, the default amount (standing order) for the settlement of night batches stemming from SSS has to be adapted till the end of the current business day (18.00) with effect for the next business day, that is the night-time processing.

Initiator of reservation

To ensure that credit institutions maintain full control of their liquidity management, only RTGS account holders are generally allowed to transfer the dedicated liquidity.

There is also the possibility that ancillary systems (or a CB on behalf of an AS) may submit a request for “setting aside” liquidity on behalf of the participant.

- 2.5 Liquidity management
- 2.5.4 Effect of reservation and definition of limits (examples)

2.5.4 Effect of reservation and definition of limits (examples)

2.5.4.1 Examples for the effects of reservations

Effect of reservation

The following diagram shows the effect of reservations on the use of liquidity for highly urgent, urgent and normal payments:

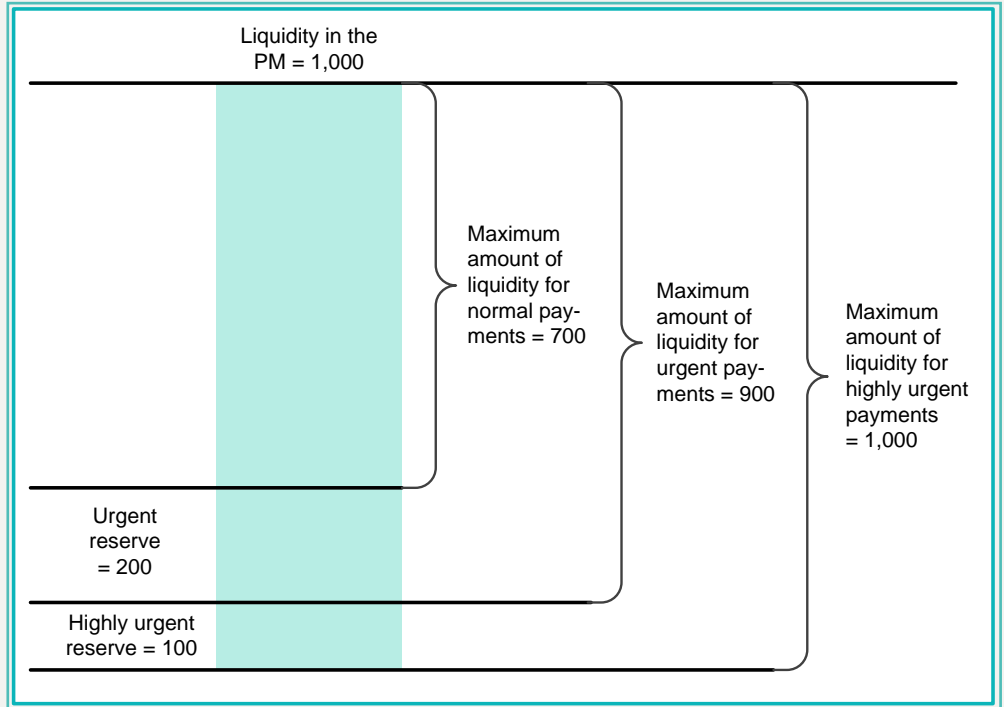

The following table explains the effect of the reservation functionality:

Effect	Highly urgent payment	Urgent payment
Available liquidity	Balance on RTGS account + credit line (if available)	Balance on RTGS account + credit line (if available)

2 User Guide for Payments Module (PM)

2.5 Liquidity management

2.5.4 Effect of reservation and definition of limits (examples)

Effect	Highly urgent payment	Urgent payment
		./. highly urgent reserve
Effect of outgoing payments	<ul style="list-style-type: none"> • Reduction of balance on RTGS account • Reduction of highly urgent reserve • If the highly urgent reserve is not sufficient, the liquidity will be used as follows: <ol style="list-style-type: none"> 1) available liquidity for normal payments. 2) reduction of the urgent reserve. 	<ul style="list-style-type: none"> • Reduction of balance on RTGS account • Reduction of urgent reserve
Effect of incoming payments	Increase of balance on RTGS account	Increase of balance on RTGS account

Normal payments have access, at all times, to

the balance on the RTGS account

+ credit line (if available)

./. highly urgent reserve

./. urgent reserve.

The following tables give further explanations on the basis of numeric examples.

Note: It is assumed that no credit line is available.

2 User Guide for Payments Module (PM)

2.5 Liquidity management

2.5.4 Effect of reservation and definition of limits (examples)

Settlement by (highly) urgent funds

Activity	Balance on RTGS account	Highly urgent reserve	Urgent reserve	Available liquidity for normal payments
Start	1,000	100	200	700
Settlement of ancillary system = 50 (debit)	950 ↓	50 ↓	200 ↔	700 ↔
Submitting urgent payment to Bank B = 200	750 ↓	50 ↔	0 ↓	700 ↔
Submitting normal payment to Bank C = 20	730 ↓	50 ↔	0 ↔	680 ↓
Settlement of ancillary system = 100 (credit)	830 ↑	50 ↔	0 ↔	780 ↑
Incoming urgent payment from Bank B = 50	880 ↑	50 ↔	0 ↔	830 ↑

2 User Guide for Payments Module (PM)

- 2.5 Liquidity management
- 2.5.4 Effect of reservation and definition of limits (examples)

Activity	Balance on RTGS account	Highly urgent reserve	Urgent reserve	Available liquidity for normal payments
Incoming normal payment from Bank C = 30	910 ↑	50 ↔	0 ↔	860 ↑
Set a new urgent reservation with immediate effect = 500	910 ↔	50 ↔	500 ↑	360 ↓
Settlement of highly urgent payment in favour of CB = 450 (debit)	460 ↓	0 ↓	460 ↓	0 ↓

(AS) Settlement on sub-account

Activity	Balance on RTGS account	Highly urgent reserve	Urgent reserve	Dedicated liquidity for AS1 (on subaccount)
Start	1,000	100	200	200
Settlement of ancillary system AS1 = 50 (debit)	1,000 ↔	100 ↔	200 ↔	150 ↓
Submitting urgent payment to Bank B = 200	800 ↓	100 ↔	0 ↓	150 ↔
Submitting normal payment to Bank C = 20	780 ↓	100 ↔	0 ↔	150 ↔
Settlement of	780	100	0	250

2 User Guide for Payments Module (PM)

2.5 Liquidity management

2.5.4 Effect of reservation and definition of limits (examples)

Activity	Balance on RTGS account	Highly urgent reserve	Urgent reserve	Dedicated liquidity for AS1 (on subaccount)
ancillary system AS1 = 100 (credit)	↔	↔	↔	↑
Incoming urgent payment from Bank B = 50	830 ↑	100 ↔	0 ↔	250 ↔
Incoming normal payment from Bank C = 30	860 ↑	100 ↔	0 ↔	250 ↔
Incoming highly urgent payment from CB = 40	900 ↑	100 ↔	0 ↔	250 ↔
Settlement of ancillary system AS2 = 120 (debit) by highly urgent funds/reserves	780 ↓	0 ↓	0 ↔	250 ↔
Release dedicated liquidity AS1 (after settlement cycle)	1,030 ↑	0 ↔	0 ↔	0 ↓

Note: Dedicated liquidity is only set aside for settlement of ancillary system AS1. Total liquidity of the participant is the sum of balances on RTGS accounts and on sub-accounts.

General effect of limitation

2.5.4.2 Examples for the effects of limits

The following table explains the effects of the limits:

Normal payment	
Available liquidity	Balance on RTGS account + credit line (if available) ./. highly urgent reserve ./. urgent reserve
Effect of outgoing payments (debits*)	<ul style="list-style-type: none">• Reduction of balance on RTGS account• Reduction of bilateral or multilateral position (Payments will be queued, if bilateral or multilateral position would exceed the limits)
Effect of incoming payments (credits*)	<ul style="list-style-type: none">• Increase of balance on RTGS account• Increase of bilateral or multilateral position

* Direct debits effect the bilateral/multilateral position just the other way round because outgoing payments are credits and incoming payments are debits.

Note:

- A bilateral or multilateral limit with an amount of zero is a limit which is not defined.
- A multilateral limit can only be defined or will be valid if at minimum one bilateral limit towards another direct participant is defined (see description and effect of multilateral limit in chapter [2.5.2.2 Multilateral limit, page 67](#)).

2 User Guide for Payments Module (PM)

- 2.5 Liquidity management
- 2.5.4 Effect of reservation and definition of limits (examples)

Bilateral limit

The following diagram shows the effect of the bilateral limit on the use of liquidity for normal payments:

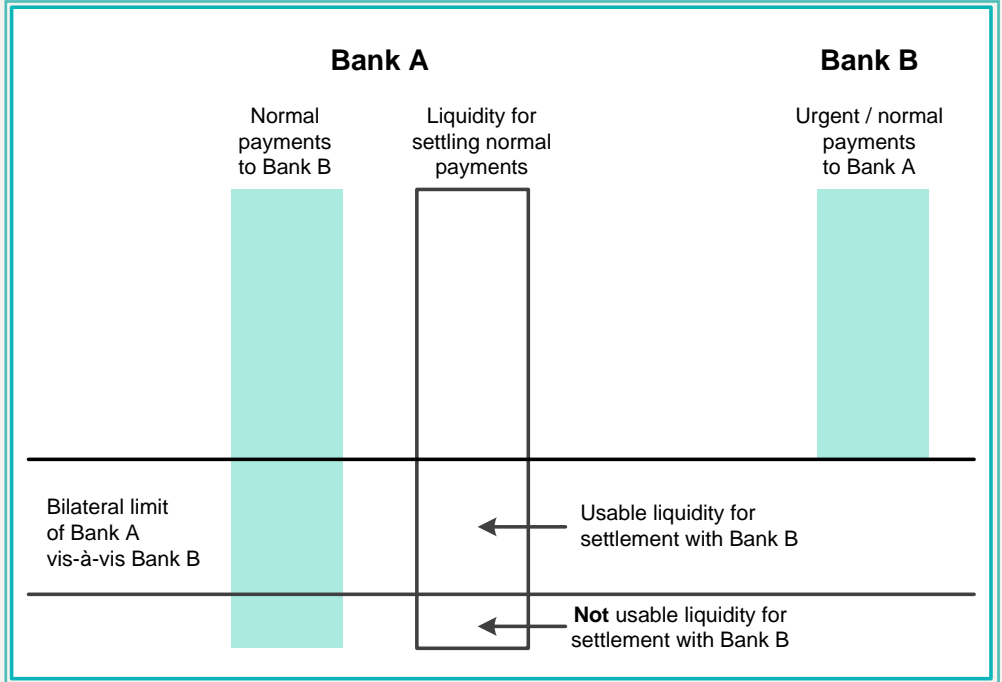

The processing of normal payments in case Bank A has set a bilateral limit for Bank B is illustrated in the following simplified example:

Bilateral relation	Bilateral limit set	Submitted normal payments	Explanation
Bank A vis-à-vis Bank B	3 million EUR	10 million EUR	Up to a maximum of 3 million EUR of Bank A's liquidity will be used to settle normal payments between Bank A and Bank B.
Bank B vis-à-	Not relevant	6 million	If Bank A has sufficient liquidity available, a max-

2 User Guide for Payments Module (PM)

2.5 Liquidity management

2.5.4 Effect of reservation and definition of limits (examples)

Bilateral relation	Bilateral limit set	Submitted normal payments	Explanation
vis Bank A	in this example	EUR	<p>imum of 9 million EUR from Bank A and 6 million EUR from Bank B can be settled. 1 million EUR from Bank A cannot be settled and are queued until</p> <ul style="list-style-type: none">• additional payments (urgent/normal) from Bank B will be settled or• Bank A increases the bilateral limit to an amount of 4 million EUR. <p>Otherwise the normal payments will not be settled and will be rejected by the end of the day.</p>

2 User Guide for Payments Module (PM)

- 2.5 Liquidity management
- 2.5.4 Effect of reservation and definition of limits (examples)

Multilateral limit

The following diagram shows the effect of the multilateral limit on the use of liquidity for normal payments:

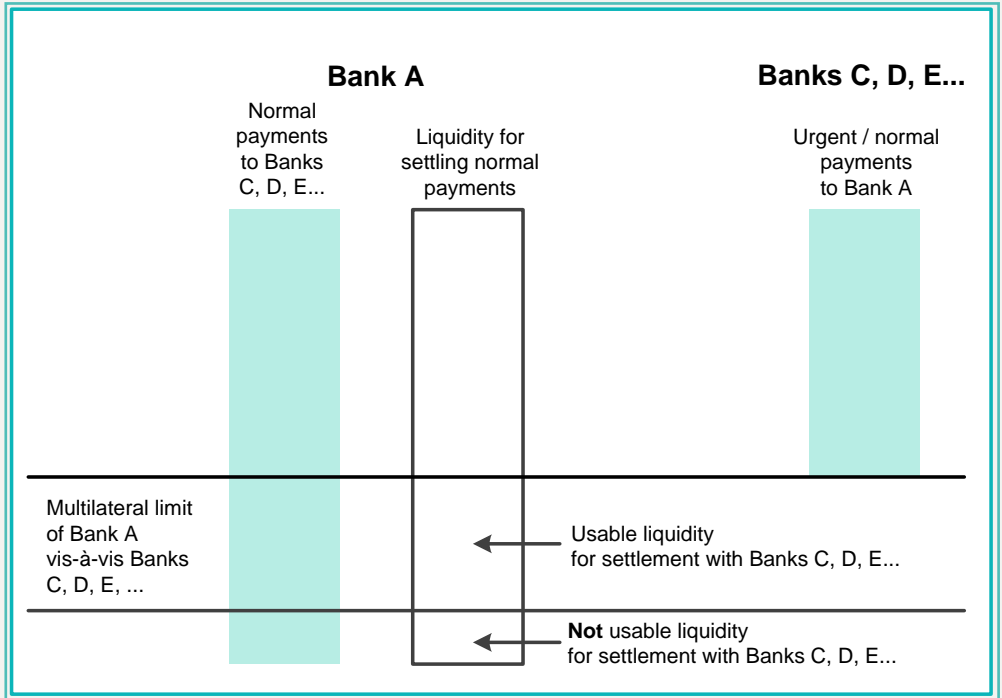

The processing of normal payments in the case of Bank A has set a multilateral limit is illustrated in a following simplified example (Bank A has not defined bilateral limits vis-à-vis those banks):

Multilateral relation	Multilateral limit set	Submitted normal payments	Explanation
Bank A vis-à-vis Banks C, D, E, ...	2 million EUR	20 million EUR	Up to a maximum of 2 million EUR of Bank A's liquidity will be used to settle payments between Bank A and Banks C, D, E, ...

2 User Guide for Payments Module (PM)

2.5 Liquidity management

2.5.5 Pooling of liquidity

Multilateral relation	Multilateral limit set	Submitted normal payments	Explanation
Banks C, D, E, ... vis-à-vis Bank A	Not relevant in this example	15 million EUR	<p>If Bank A has sufficient liquidity available, a maximum of 17 million EUR from Bank A and 15 million EUR from Banks C, D, E, ... can be settled.</p> <p>3 million EUR from Bank A cannot be settled and are queued until</p> <ul style="list-style-type: none">• additional payments (urgent/normal) of Banks C, D, E,... will be settled or• Bank A increases the multilateral limit to an amount of 5 million EUR. <p>Otherwise the normal payments will not be settled and rejected by the end of the day.</p>

2.5.5 Pooling of liquidity

2.5.5.1 Description and possible options

Definition

Banks are able to use a liquidity pooling functionality to view and use their liquidity irrespective on which RTGS account it is held in the PM.

The liquidity pooling function is an optional service.

Objectives

- Avoiding liquidity fragmentation in the PM, esp. for
 - multinational banks
 - a group of banks
 - banks holding a number of accounts (eg different sections)
- Simplifying the liquidity disposition and usage
- Access to the overall liquidity from different locations

2 User Guide for Payments Module (PM)

- 2.5 Liquidity management
- 2.5.5 Pooling of liquidity

“Group of accounts”

The PM offers liquidity pooling services, relying on the so-called “group of accounts” structure. A group of accounts consists of one or several RTGS account(s) in the books of one or several SSP CBs. In this sense each account is assigned to one BIC. The accounts can be held by one or several participant(s) in the PM. RTGS accounts of Internet-based participants cannot be part of a group of accounts.

Account level

The liquidity on these RTGS accounts is “pooled at group of accounts level”. This can be done:

Level	Explanation
On domestic level	A group of accounts is comprised of accounts held at the same central bank.
On cross-border level	A group of accounts is comprised of accounts held at different central banks; this may, in particular, be the case for multinational credit institutions.

Grouping of accounts on domestic and cross-border level

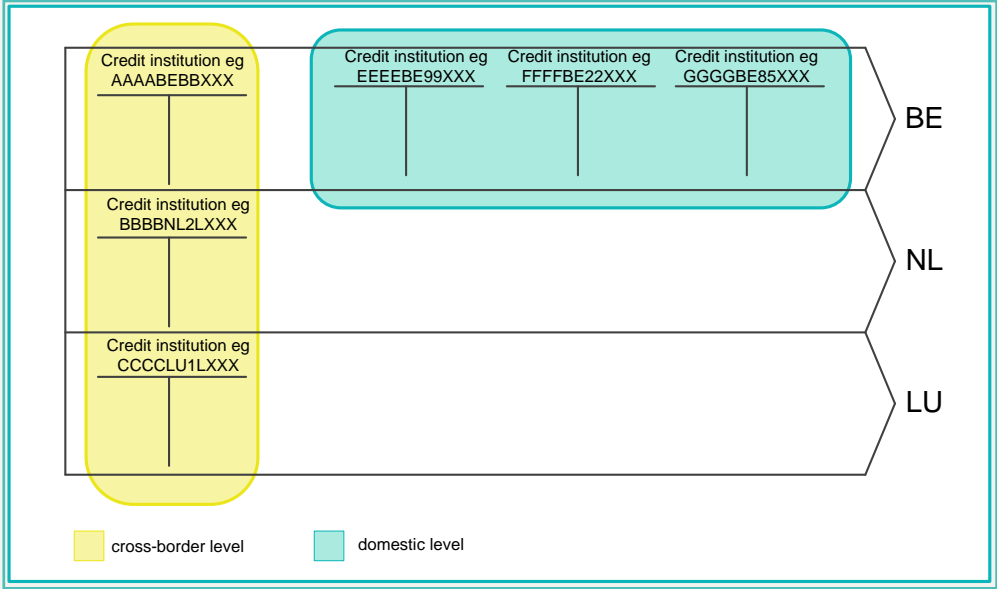

Two variants

TARGET2 offers two variants for the pooling of liquidity:

- virtual account
- consolidated information

If a group of PM participants wants to pool their liquidity they can decide to use one of the two variants. Opting for virtual account includes systematically the option for consolidated information. Information and all interactive control measures are offered via the ICM.

Joining the group

A given RTGS account can only be assigned exactly to one group of accounts (strict 1:1 relation). This means, a given account can be assigned to one virtual account and one group of accounts formed for provision of consolidated information at the same time.

If a participant decides to use a virtual account and the consolidated information, all accounts forming the virtual account have to belong to the group of accounts formed for the provision of consolidated information. It is not possible that one account out of the accounts forming the virtual account remains outside.

Examples

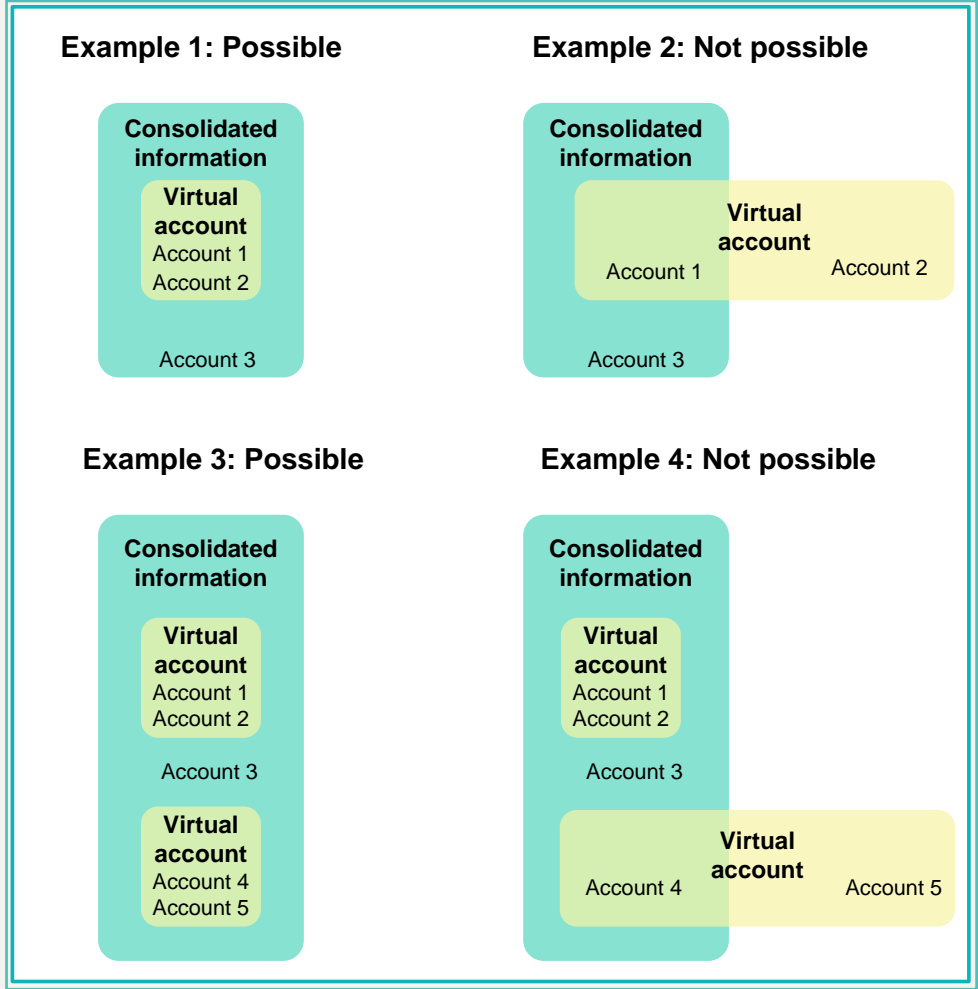

2.5.5.2 Virtual account

Definition

For all RTGS accounts belonging to one group, a virtual account is created.

The virtual account is formed with the purpose of aggregating the relevant data of the single accounts, ie the virtual account registers the global liquidi-

2 User Guide for Payments Module (PM)

2.5 Liquidity management

2.5.5 Pooling of liquidity

ty position of the group. Due to its nature, no separate BIC is assigned to the virtual account. One RTGS account inside the virtual account has to be assigned as master account (under the responsibility of a group of accounts manager).

The virtual account is the reference for the liquidity management within the group. Therefore, almost all liquidity management features are only available at group level.

Inclusion/ exclusion

Included accounts	<ul style="list-style-type: none">• RTGS accounts of SWIFT-based direct participants held with euro area CBs• related sub-accounts for dedicated liquidity (for information purposes only) <p>Note: The pooled liquidity is available to be transferred to a sub-account. This can be done by the single RTGS account holder and the group of accounts manager.</p>
Excluded accounts	<ul style="list-style-type: none">• Home accounts in the HAM and in proprietary home accounting systems• Accounts with central banks held on SSS platforms (ie real-time model)• RTGS accounts of remote participants• RTGS accounts held with non-euro area CBs• RTGS accounts in case of legal restrictions• RTGS accounts of Internet-based direct participants

“Single accounts”

The single accounts continue to be the legal relevant “book” of the participant vis-à-vis its CB.

Each transaction processed within a group of accounts is immediately booked on the single account. In case a negative balance will occur on a single account covered by liquidity available on other accounts belonging to the same group an appropriate legal arrangement will ensure that the interests of each CB involved will be respected at all times and under all circum-

2 User Guide for Payments Module (PM)

2.5 Liquidity management

2.5.5 Pooling of liquidity

Intraday liquidity available

stances. In addition, credit lines are only implemented at single account level.

The intraday liquidity available to settle the payment orders sent by a given participant is defined as follows:

Sum of all balances of the RTGS accounts belonging to the group of accounts

+ if available: sum of all credit lines of the RTGS accounts belonging to the group of accounts

= Available liquidity

Examples

The examples are snap-shots of liquidity situations arisen during the operating day.

	AAAABEBB	BBBBL2L	CCCCLU1L	Virtual account
Example 1				
Credit line	1500	0	0	= 1500
Balance	500	-700	300	= 100
Liquidity available	2000	-700	300	= 1600
Example 2				
Credit line	1500	0	100	= 1600
Balance	-400	-100	-200	= -700
Liquidity available	1100	-100	-100	= 900

Single payment queue

The liquidity management within one group refers to the “virtual account“ at group level. Consequently, one of the main features of the “group of accounts“ functionality is the existence of a “single payment queue“.

2 User Guide for Payments Module (PM)

2.5 Liquidity management

2.5.5 Pooling of liquidity

When a payment is posted to the RTGS account of the ordering bank, the possibility to debit the RTGS account is assessed against the “liquidity available” in the group of accounts to which that RTGS account belongs.

If

- the “liquidity available” (under consideration of highly urgent and urgent reserve) is bigger or equal to the value of the payment order and
- in case of a normal payment no limit (if defined) is breached

the RTGS account of the ordering bank will be debited, even if this results in a negative balance on this RTGS account. Otherwise, the payment order is queued.

To resolve the queue with pending (highly) urgent and normal transactions always the aggregated amount of liquidity is taken into consideration.

The group of accounts comprises three RTGS accounts belonging to Bank A (AAAABEBB), Bank B (BBBBNL2L) and Bank C (CCCCLU1L):

Illustration of the settlement process (1)

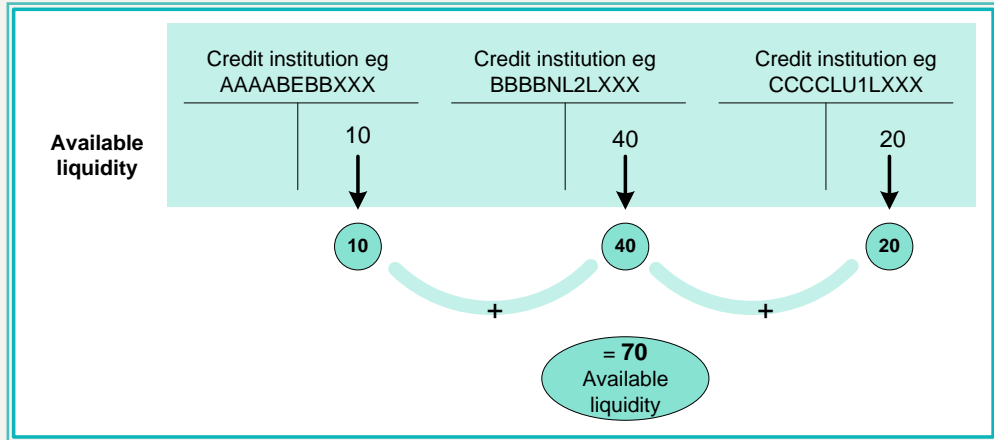

Suppose that Bank A initiates a credit transfer of 50 in favour of Bank X. Although the balance on the RTGS account of Bank A is only 10, the transfer is executed because the group of accounts overall available liquidity is

2 User Guide for Payments Module (PM)

2.5 Liquidity management

2.5.5 Pooling of liquidity

Illustration of the settlement process (2)

sufficient (70). The available liquidity on the RTGS accounts within the group of accounts evolves as follows:

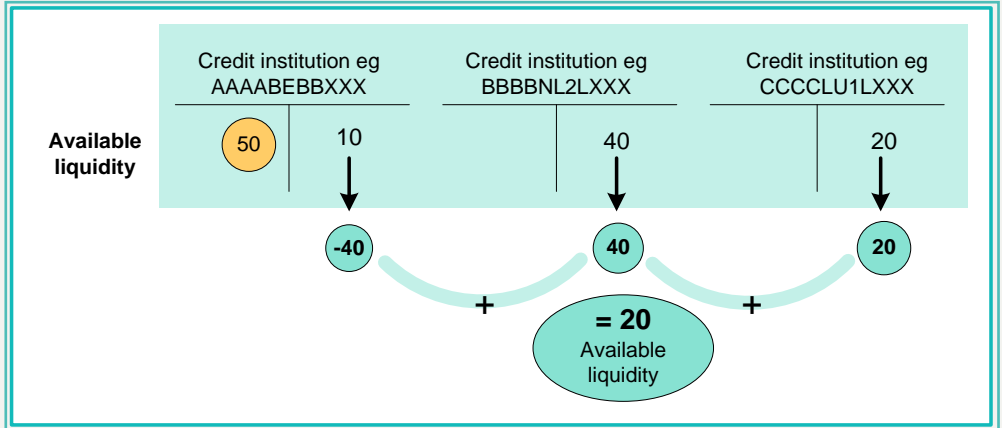

Group of accounts manager

To offer, on the one side, an overall view on the liquidity status of the group, but on the other side to follow the interests of all involved single account holders, it is not useful to implement intraday liquidity management facilities at the RTGS account level. The global position can only be managed at central level by a so-called group of accounts manager.

Therefore, the group of accounts manager should be entrusted with all powers on all RTGS accounts within the group of accounts. In particular the group of accounts manager is responsible for the intraday monitoring of the “liquidity available” at the group of accounts level.

Note: The group of accounts manager’s responsibilities regarding intraday monitoring of the “liquidity available” can include, when relevant, intraday credit operations. However, such intraday credit operations (ie provision/reimbursement) will remain at the level of each single RTGS account (ie not at the level of the group of accounts).

Each holder of (an) RTGS account(s) within the group of accounts

- shall be the usual contact vis-à-vis the relevant central bank for all issues pertaining to “its” RTGS account and to the group of accounts,

2 User Guide for Payments Module (PM)

2.5 Liquidity management

2.5.5 Pooling of liquidity

Information access

- is responsible for ensuring the compliance of its institution with the minimum reserve requirements - if any - and it is the responsibility of the group of accounts manager to establish an adequate internal organisation for this.

In accordance with the different functions available, the information access is differentiated as follows:

Actor	Access
Manager of the group of accounts	Access to the virtual account and to detailed information on all accounts (except payment details) in the group (inclusive sub-accounts)
Single account holders	Access to the detailed information (including payment details) of its respective account and to consolidated information of the group of accounts

Note: For the group of accounts manager the following “payment details” are available via ICM: BIC of the sender and the receiver, amount, TRN, message type, type of payment, timestamps and payment status.

Possible interaction

In accordance with the different functions available, the possibility to interactively control the single payment queue is differentiated as follows:

Interaction	Actor	
	Manager of the group of accounts	Single account holders
Change of priorities	possible	possible
Revocation	possible	possible
Change execution time	possible	possible
Dedication of liquidity on sub-accounts and withdrawing it	possible	possible

2 User Guide for Payments Module (PM)

- 2.5 Liquidity management
- 2.5.5 Pooling of liquidity

Interaction	Actor	
	Manager of the group of accounts	Single account holders
Re-ordering of queued transactions	possible	not possible
Reservation of liquidity, possible for the whole group only	possible	not possible
Definition and change of limits, possible for the whole group only	possible	not possible

Definition and use of limits by the group of accounts manager

As indicated above, liquidity management features are mainly available at group level. Therefore, it is, for example, not possible to set limits between accounts belonging to one group.

In addition, it is only possible for the group of accounts manager to define a bilateral limit for the whole group. It is not possible to define a bilateral limit on a single account level. (Same rule concerning definition of multilateral limit.)

Examples

The following examples show how limits are used with regard to the group of accounts:

	AAAABEBB	BBBBL2L	CCCCLU1L	Virtual account	
				Liquidity	Bilateral limit (position) vis-à-vis DDDDDEFF (DDDDEFF does not belong to the group)

2 User Guide for Payments Module (PM)

2.5 Liquidity management

2.5.5 Pooling of liquidity

	AAAABEBB	BBBBNL2L	CCCCLU1L	Virtual account	
				Liquidity	Bilateral limit (position) vis-à-vis DDDDDEFF (DDDDEFF does not belong to the group)
	2000	-700	300	1600	500
Example 1	AAAABEBB submits a normal payment (1500) in favour of DDDDDEFF. The available liquidity would be sufficient ($1500 < 1600$), but the payment would not be settled owing to the fact that the bilateral limit is breached ($500 < 1500$).				
Example 2	BBBBNL2L submits a payment (400) in favour of DDDDDEFF. The available liquidity is sufficient ($400 < 1600$) and the bilateral limit is also sufficient ($400 < 500$).				
	2000	-1100	300	1200	100

Definition and use of limits by other PM participants

A bilateral limit can only be defined vis-à-vis a group of accounts. It is not possible to define a bilateral limit vis-à-vis a single account holder.

Example: DDDDDEFF has defined a bilateral limit of 400 vis-à-vis the virtual group consisting of AAAABEBB, BBBBNL2A, CCCCLU1L. DDDDDEFF is aware of the banks forming a group of accounts due to the information provided in the ICM.

2 User Guide for Payments Module (PM)

2.5 Liquidity management

2.5.5 Pooling of liquidity

DDDDDEFF submits a normal payment (300) in favour of BBBBNL2L. Given sufficient liquidity on the RTGS account of DDDDDEFF the payment is settled owing to the fact that the bilateral limit is sufficient.

On group of accounts level the payment of DDDDDEFF changes the liquidity and balance situation as follows:

	AAAABEBB	BBBPNL2L	CCCCLU1L	Virtual account	
				Liquidity	Bilateral limit (position) vis-à-vis DDDDDEFF (DDDDDEFF does not belong to the group)
Basic situation	2000	-700	300	1600	500
Situation after transaction	2000	-400	300	1900	800

Liquidity transfer

The group of accounts manager has the possibility to transfer liquidity between the single accounts belonging to his/her group (inclusive sub-accounts) via the ICM. The liquidity transfer is processed immediately. A liquidity transfer in favour of a sub-account will be executed immediately only if received before the first cycle or between two cycles. During a running cycle the liquidity transfer in favour of a sub-account will be stored and only executed immediately after the “end-of-cycle” message (see chapter [2.8 Settlement of ancillary systems, page 174](#)).

End-of-day procedure

Liquidity pooling is available intraday. Therefore, the group of accounts manager has to level out the accounts belonging to the group till 18.00.

As a contingency measure, an automatic end-of-day procedure assures that debit positions are levelled out against the available liquidity within the

group of accounts. This process also ensures that the available liquidity of each account - if any - does not exceed the credit line (where available).

After this end-of-day procedure, there exists no possibility for the group of accounts manager to change the liquidity within the group.

The following principles apply in the automatic end-of-day procedure:

- If the available liquidity on single RTGS accounts is negative (negative available liquidity), the negative available liquidity will be brought to zero. It might be that an intraday credit covered by securities remains. This intraday credit automatically spills over into an overnight credit.

Example:

Liquidity situation of credit institution AAAABEBB	
Balance of the RTGS account	100
Credit line	300
Available liquidity	400

Credit institution AAAABEBB sends a payment with an amount of 500. Given sufficient liquidity on the group of accounts level, the payment is settled.

Liquidity situation of credit institution AAAABEBB after settling the payment with an amount of 500	
(Negative) available liquidity	-100

During the “levelling out“ of the balances

- the intraday credit (300) automatically spills over into an overnight credit and
- the remaining negative available liquidity (-100) is brought to zero by a liquidity transfer from another account belonging to the group.

2 User Guide for Payments Module (PM)

2.5 Liquidity management

2.5.5 Pooling of liquidity

- the sequence of the accounts which is used to fund the position has to be chosen by the group of accounts manager.

Rules for “leveling out” the balances

Step 1	The group of accounts manager chooses the sequence of the accounts how they are used to fund debit balances on single accounts. The information on the choice can be given in the ICM. The sequence can be changed in the evening from 19.30 on or in the morning (after technical maintenance period) as from 1.00 on with immediate effect. The choice is valid till the next change.
Step 2	Accounts with a negative available liquidity are brought to zero. To fund these accounts, accounts with positive available liquidity are used according to the sequence chosen by the group of accounts manager.

2 User Guide for Payments Module (PM)

- 2.5 Liquidity management
- 2.5.5 Pooling of liquidity

Levelling out the balance

Sequence list of the accounts of the group of accounts manager:

1. Bank B (BBBBNL2L)
2. Bank A (AAAABEBB)
3. Bank C (CCCCLU1L)

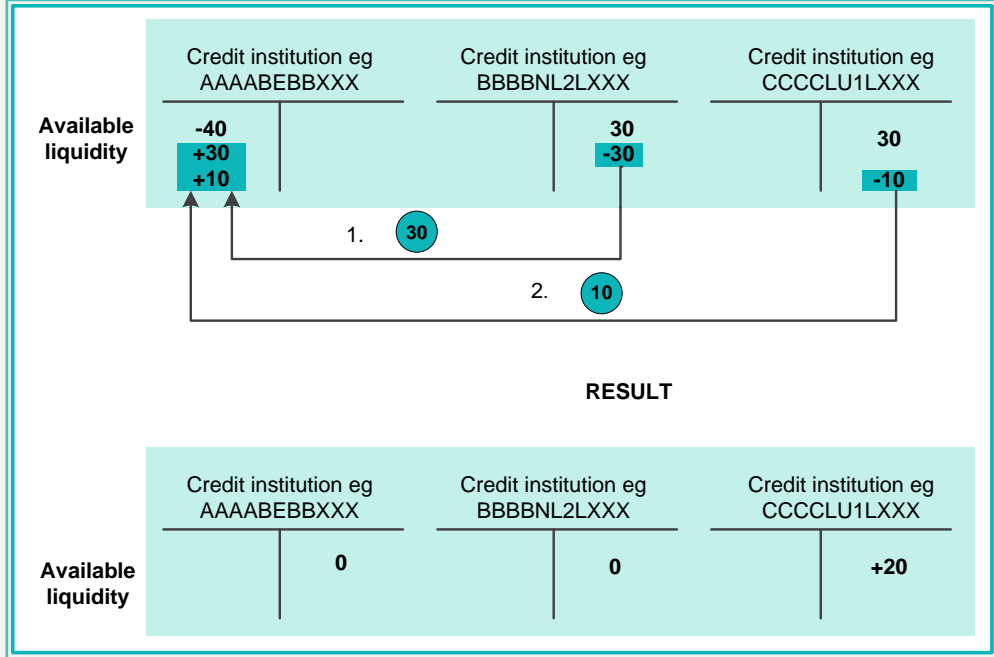

Information and access rights for CBs

Owing to the following tasks of a central bank in TARGET2, CBs need access to the information on accounts.

- Provision of help desk functions to their customers
- Performing of local contingency
- Monitoring of liquidity positions
- Ensuring the adequacy of collateral management to cover a negative available liquidity position on a single account belonging to the group.

2 User Guide for Payments Module (PM)

2.5 Liquidity management

2.5.5 Pooling of liquidity

In any case, the CBs must be able to fulfil their responsibility with regard to “maintaining business relations”.

Since a number of CBs might be involved in one group of accounts, it has been defined which information and access rights are available.

Example

	Central bank of Belgium (= Home CB of AAAABEBB)	Central bank of the Netherlands (= Home CB of master account and BBBBNL2L)	Central bank of Luxembourg (=Home CB of CCCCLU1L)
AAAABEBB			
• Credit line	X	X	
• Balance (also on sub-accounts)	X	X	
• Sum of turnover	X	X	
• Settled items	X	X	
• Queued items	X	X	
• Payment details	X		
BBBPNL2L (= Master account)			
• Credit line		X	
• Balance (also on sub-accounts)		X	
• Sum of turnover		X	
• Settled items		X	
• Queued items		X	
• Payment details		X	

2 User Guide for Payments Module (PM)

2.5 Liquidity management

2.5.5 Pooling of liquidity

	Central bank of Belgium (= Home CB of AAAABEBB)	Central bank of the Netherlands (= Home CB of master account and BBBBNL2L)	Central bank of Luxembourg (=Home CB of CCCCLU1L)
CCCCLU1L			
• Credit line		X	X
• Balance (also on sub-accounts)		X	X
• Sum of turnover		X	X
• Settled items		X	X
• Queued items		X	X
• Payment details			X
Virtual account			
• Sum of credit lines	X	X	X
• Sum of balances	X	X	X
• Sum of balances of sub-accounts	X	X	X
• Limits	X	X	X
• Reserves	X	X	X
• Sum of turnover	X	X	X
• Sum of settled items	X	X	X
• Sum of queued items	X	X	X

2.5.5.3 Consolidated information

Definition

For all accounts belonging to one group, consolidated information is provided in the ICM. The service consists of:

- provision of information
- possibilities to transfer liquidity between the accounts belonging to one group

If all or part of the accounts belonging to one virtual account are in addition comprised to get consolidated information, the rules described in the paragraphs “[Virtual account](#)“, “[Virtual account](#)“, “[Virtual account](#)“, “End-of-day procedure“ in chapter [2.5.5.2 Virtual account, page 82](#) apply.

Inclusion/ exclusion

Included accounts	<ul style="list-style-type: none">• RTGS accounts of SWIFT-based direct participants held with euro area CBs• RTGS accounts of SWIFT-based direct participants held with non-euro area CBs• RTGS accounts of SWIFT-based direct remote participants• related sub-accounts (for dedicated liquidity)
Excluded accounts	<ul style="list-style-type: none">• Home accounts in the HAM and in proprietary home accounting facilities• Accounts with central banks held on SSS platforms (ie real-time model)• RTGS accounts in case of legal restrictions• RTGS accounts of Internet-based direct participants

2 User Guide for Payments Module (PM)

2.5 Liquidity management

2.5.5 Pooling of liquidity

Information access

Actor	Access
Manager of the group of accounts	Access to consolidated and detailed information (except payment details) of all accounts in the group (inclusive sub-accounts)
Single account holders	Access to detailed information (including payment details) of the respective account and to consolidated information of the group of accounts

Consolidated information

Under consolidated information is understood information aggregated on group of accounts level:

- Sum of credit lines
- Sum of balances (also balances on sub-accounts)
- Sum of turnover
- Sum of settled items
- Sum of queued items
- List of accounts belonging to the group (bank name, location and BIC)

Detailed information

Under detailed information is understood:

- Credit line of each single account
- Balances, (inclusive balances on sub-accounts) of each single account
- Reserves of each single account
- Limits on single account level
- Settled items of each single account
- Queued items of each single account
- Static data of each single account

Disposition

The single account holder has access to detailed information (including payment details) of its respective account and to consolidated information of the group of accounts.

The group of accounts manager has the possibility to debit and credit all the accounts belonging to the group (inclusive sub-accounts). The liquidity can be transferred using a special functionality offered to the group of accounts manager in the ICM. The functionality is available from 1.00 to 22.00 (except from 18.00 to 19.30).

Note: A liquidity transfer in favour of a sub-account will be executed immediately only if received before the first cycle or between two cycles (see chapter [2.8 Settlement of ancillary systems, page 174](#)).

Information and access rights for CBs

Actor	Access
Home CB of group of accounts manager	Access to consolidated and detailed information (except payment information) of all accounts in the group (inclusive sub-accounts)
Home CB of single account	Access to detailed information of the respective account (inclusive sub-accounts) and to consolidated information of the group of accounts

2.6 Flow of payments

Introduction

The first part of this chapter contains a description of the payment interface of the PM and the second part explains the individual steps of a payment on its way to the receiving party.

During the whole flow of payments, the direct participants have access to the complete information on their incoming and outgoing payments in the ICM. In addition, the ICM offers an extensive range of interactive control functionalities.

Basic principles

2.6.1 Payment Interface

- The interface between the PM and its participants is SWIFT-based in order to follow a so-called “single window“ access for the direct PM participants.
- The PM uses the SWIFTNet FIN Y-copy service for the processing of all payments with a dedicated SWIFT Closed User Group (CUG) for this purpose. The PM receives a full copy of each payment to allow an efficient and comprehensive provision of information in the ICM.
- The provision of MT 011 (delivery notification) is an optional valueadded service proposed by SWIFT. It is consequently up to each participant to decide to use or not this service which is totally outside the scope of the SSP.
- Internet-based participants do not have direct access to the payment interface. They have to use ICM U2A functions to issue payments and to get information about incoming and outgoing payments. Credit transfers to SWIFT-based direct PM participants issued via the Internet ICM interface will be transformed by PM into SWIFTNet FIN Y-copy messages and sent out to SWIFT. The settlement will be done on the basis of the incoming MT 096 from SWIFT (not on the basis of the ICM order).

2 User Guide for Payments Module (PM)

- 2.6 Flow of payments
- 2.6.1 Payment Interface

Flow of messages between SWIFT-based participants in general

The following slide illustrates the payment interface of the PM for the MT 103 (+) and MT 202 (COV) - using the SWIFTNet FIN Y-copy service and SWIFT-based participants on sender and receiver side:

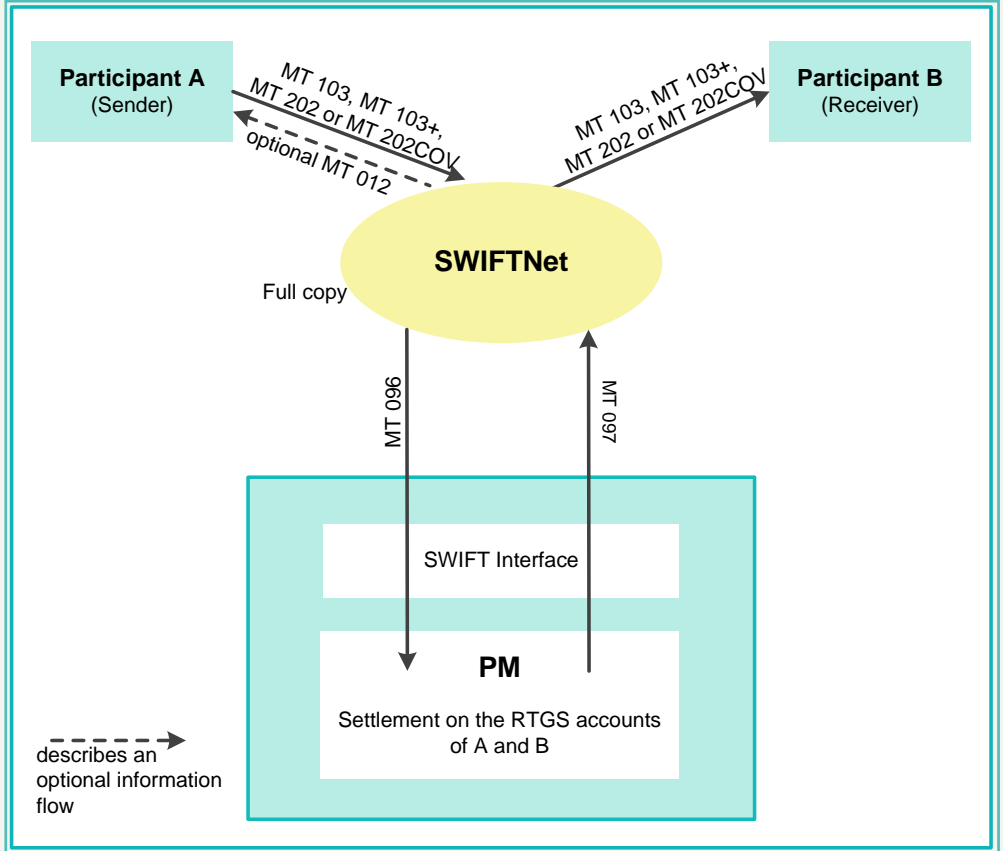

2 User Guide for Payments Module (PM)

- 2.6 Flow of payments
- 2.6.1 Payment Interface

The following slide illustrates the payment interface of the PM for the MT 204 - using the SWIFTNet FIN Y-copy service and SWIFT-based participants on sender and receiver side:

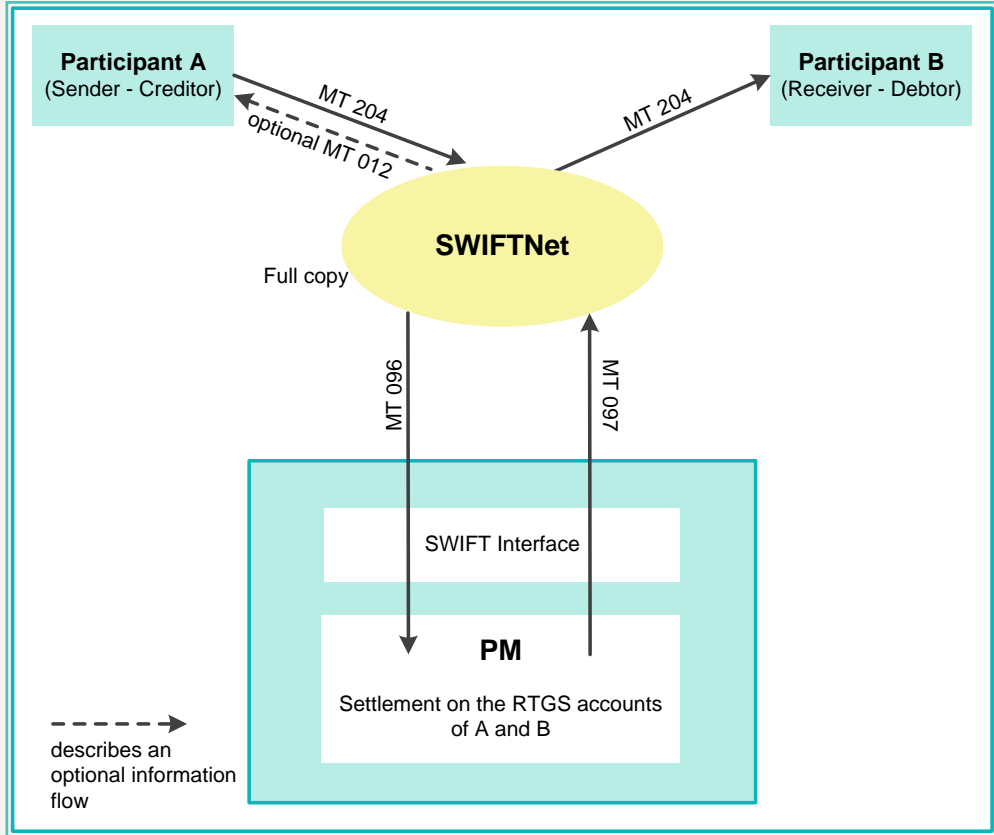

2 User Guide for Payments Module (PM)

- 2.6 Flow of payments
- 2.6.1 Payment Interface

The following slide illustrates the flow of messages if SWIFTNet FIN is used without Y-copy
- in case of payments from HAM accounts to PM see chapter [2.6.2.2.3 ... from a HAM account holder, page 135](#).

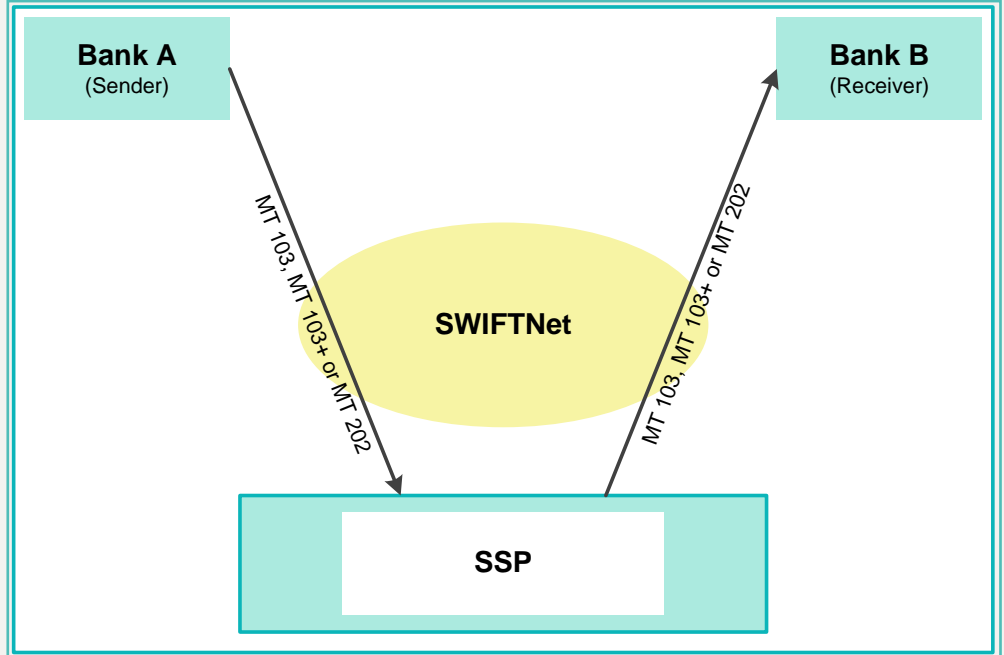

2 User Guide for Payments Module (PM)

- 2.6 Flow of payments
- 2.6.1 Payment Interface

Flow of messages with Internet-based participants in general

The following slide illustrates the payment interface of the PM for the MT 103 (+) and MT 202 (COV) - using the SWIFTNet FIN Y-copy service and an Internet-based participant on sender and a SWIFT-based participant on receiver side:

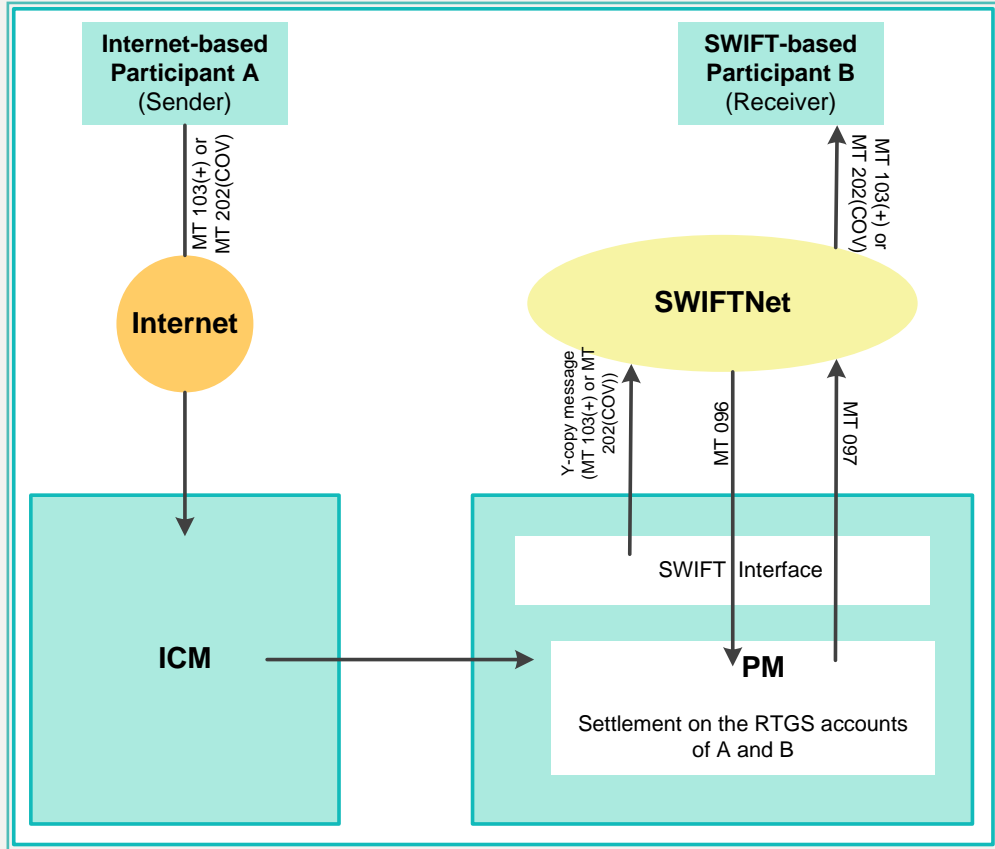

2 User Guide for Payments Module (PM)

- 2.6 Flow of payments
- 2.6.1 Payment Interface

The following slide illustrates the payment interface of the PM for the MT 103 (+) and MT 202 (COV) - using the SWIFTNet FIN Y-copy service and a SWIFT-based participant on sender and an Internet-based participant on receiver side:

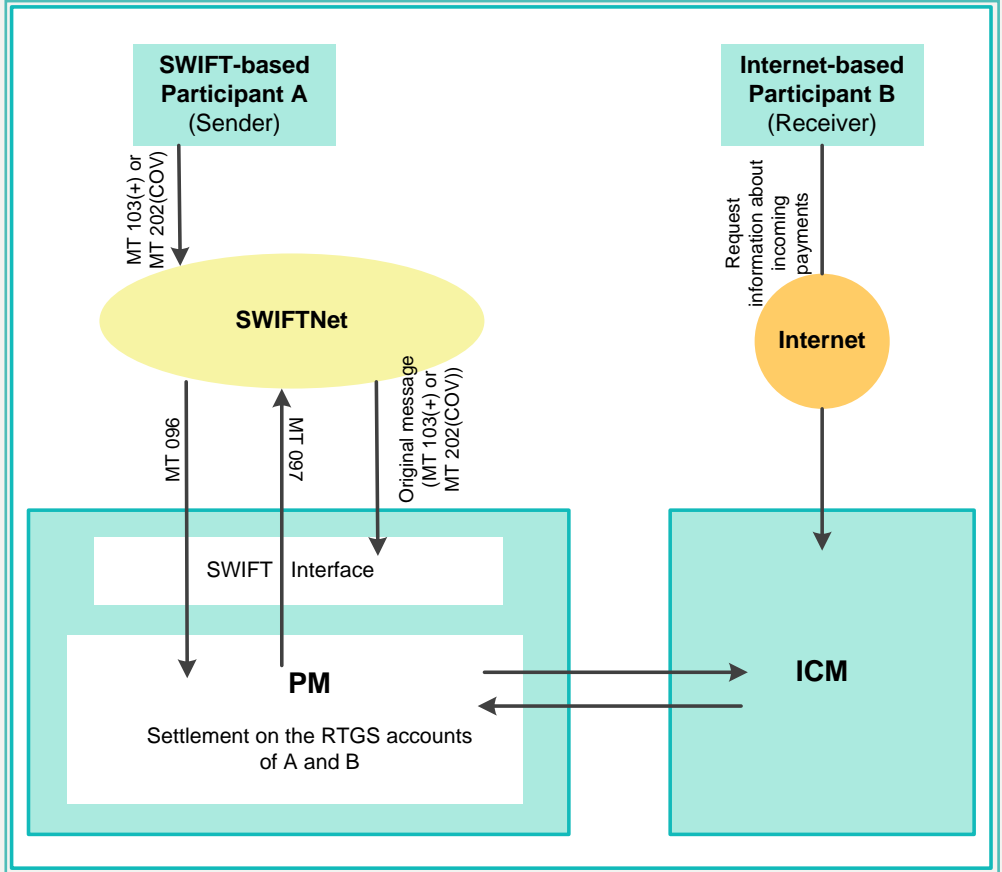

2 User Guide for Payments Module (PM)

- 2.6 Flow of payments
- 2.6.1 Payment Interface

The following slide illustrates the payment interface of the PM for the MT 103 (+) and MT 202 (COV) and Internet-based participants on sender and receiver side:

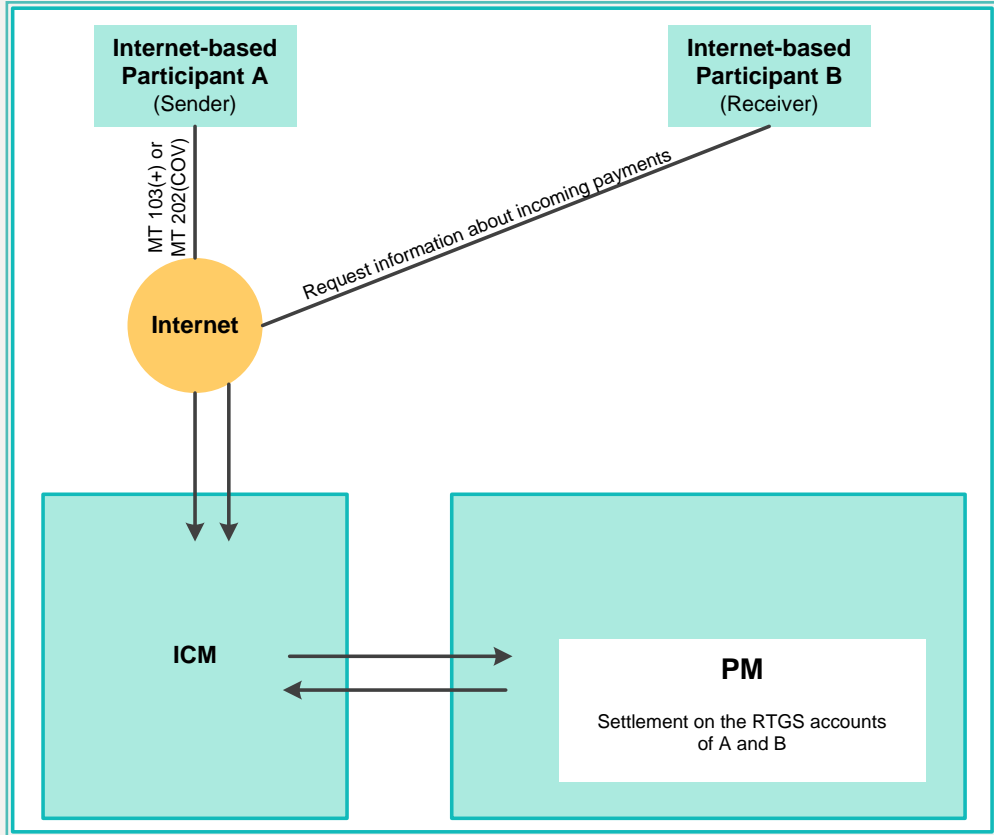

(Automatic) System messages

One aspect of the SWIFTNet FIN Y-copy service is the (optional) usage of the following system messages:

Message text	Description	Usage
MT 012	Sender notification	optional
MT 019	Abort notification	mandatory

Note:

- The sending PM participants decide individually to receive the optional message type MT 012 for their outgoing payments.
- To identify the reason for an abort notification, the MT 019 contains a descriptive error code for the direct PM participant (see chapter [9.5.2 Error codes, page 629](#)). Additional information can be obtained from the ICM or the help desk of the relevant CB.

Addressing of the receiving party

Since the SWIFTNet FIN Y-copy service is used, payments from a PM participant must be addressed to the receiving direct SWIFT-based PM participant by entering its BIC as receiver in the header of the SWIFT message. In case an Internet-based participant is the receiving party the Internet connection-dedicated PM BIC has to be used.

The addressing of payments is supported by the TARGET2 directory (comprehensive list of all PM participants with the BIC of the respective PM addressee).

Receiving party	Receiver in the SWIFT header/Entering screen
SWIFT-based direct PM participant (domestic and cross-border)	BIC of the direct PM participant
Internet-based direct PM participant	Internet connection-dedicated PM BIC

Receiving party	Receiver in the SWIFT header/Entering screen
a participant with indirect access/a participant as an “addressable BIC“	BIC of the respective direct PM participant
a participant using multi-addressee access whereby the settlement takes place on the account of the direct participant	BIC of the multi-addressee access
proprietary home account holder	BIC of the respective CB
CB as direct participant	BIC of the CB
HAM account holder	special BIC in PM related to this purpose
CB customer (with account in HAM)	Specific BIC of CB in HAM
CB customer (with account in PHA)	BIC of the CB

Examples for addressing of payments are given in chapter [9.1.2.4 Examples for addressing payments, page 502](#).

Straight through processing

In order to process as many payments as possible with a minimum of manual intervention, the PM supports straight through processing (STP) in the PM as well as in the infrastructure of the receiving direct PM participant. Therefore, mandatory field options and field contents have been determined to further promote the share of STP payments.

2.6.2 Payment flow

General aspects

The RTGS accounts of the direct PM participants are held in one technical platform. Debiting the sending participant’s account and crediting the receiving participant’s account are made simultaneously.

The accounts to be debited and credited are identified by the respective fields in the basic header (sender) and the application header (receiver) of the payment message.

After simultaneous booking on the RTGS accounts of the sender and the receiver, the payment is final and irrevocable.

Note: A payment included in the clearing process of an algorithm cannot be revoked - although it might not yet be final.

2.6.2.1 Payments sent from a direct PM participant

Overview

In the following the processing of a payment sent by the SWIFT-based direct PM participant (A) is described. A payment can be addressed to:

- another direct PM participant (B)
- a participant with indirect access/a participant as an “addressable BIC” (C)
- a HAM account holder (E)
- a CB customer (F) (with an account in HAM)
- an account holder (G) with a PHA

Note: If the originator of the payment is a PM participant with indirect access/a participant as an “addressable BIC” of A one step has to be added before the current step 1: “This PM participant instructs its related direct PM participant A to execute a payment.”

Internet access

The following detailed message flow examples are referring to SWIFT-based participants. If Internet-based participants are affected the following examples have to be amended as follows (see also general flow of messages with Internet-based participants in chapter [2.6.1 Payment Interface, page 99](#)).

If the originator of the payment is an Internet-based direct PM participant, the Internet-based participant issues a credit transfer (no issuing of MT 204 is possible) via his Internet ICM interface before step 1. Instead step 1 is performed by PM. In this case, the originator will not receive a sender notification (MT 012) as it is an Internet-based participant.

Multi-addressee access

Multi-addressee access means that the SWIFT-based direct PM participant A has authorised another BIC to send payments which are settled on the direct PM participant's RTGS account. Consequently, these payments are sent by using another BIC (ie multi-addressee access BIC) directly to the PM. However, the settlement takes place on the account of the respective direct PM participant.

Therefore, if the originator of the payment is a multi-addressee access BIC, the following examples have to be amended as follows

“Instead of the SWIFT-based direct PM participant A the multi-addressee access BIC is sending the payments. Furthermore, in this case, optional SWIFT messages like the MT 012 are sent to the multi-addressee access BIC.”

Note: Also the following slides describing the payment flow should be read as “Participant A (sender)” = multi-addressee BIC.

2.6.2.1.1 ... to another direct PM participant

MT 103/103+ and MT 202/202 COV

The following table describes the processing of a payment from the direct PM participant (A) in favour of another direct PM participant (B):

Step	Description
1	The direct PM participant A (sender) generates a payment in favour of the direct PM participant B (receiver) and addresses B in the application header of the payment.
2	The payment is temporarily stored by SWIFT.
3	A settlement request (MT 096) with a full copy is generated by SWIFT and forwarded to the PM.
4	The payment has to pass several validations (SWIFT syntax, application oriented entry checks, availability of sufficient cover etc.) before the payment is debited on

Steps of payment flow

2 User Guide for Payments Module (PM)

2.6 Flow of payments

2.6.2 Payment flow

Step	Description
	the RTGS account of A and simultaneously credited on the RTGS account of B.
5	A settlement confirmation (MT 097) is generated in the PM and forwarded to SWIFT.
6a	The settlement confirmation and the original payment are matched and the booking time is added to the original payment in the SWIFT network.
6b	The payment message is forwarded to B.
7	Optional: A can receive a sender notification (MT 012) which also contains the booking time.

2 User Guide for Payments Module (PM)

2.6 Flow of payments

2.6.2 Payment flow

Slide describing the payment flow

The following slide depicts the processing of a payment from a direct PM participant in favour of another direct PM participant:

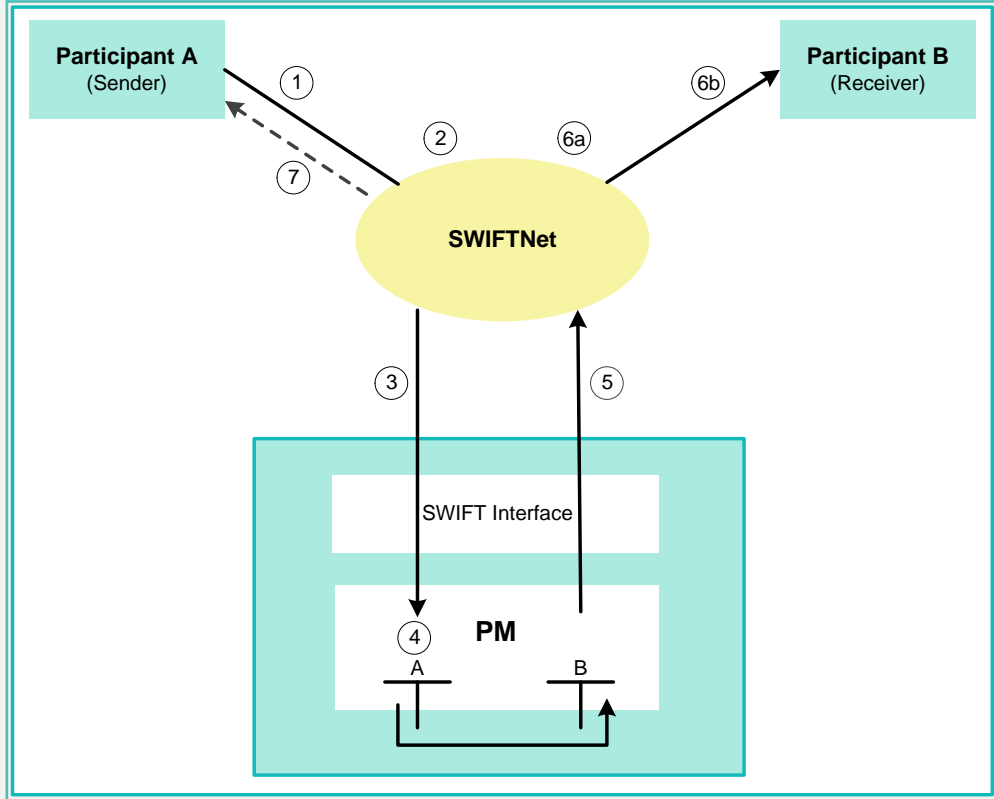

Steps of payment flow

MT 204

The following table describes the processing of a direct debit generated by a direct PM participant (A) debiting another direct PM participant (B):

Step	Description
1	The direct PM participant A (sender) generates a direct debit debiting the RTGS account of the direct PM participant B (receiver) and addresses B in the application header of the direct debit.
2	The payment is temporarily stored by SWIFT.
3	A settlement request (MT 096) with a full copy is generated by SWIFT and forwarded to the PM.
4	The direct debit has to pass several validations (SWIFT syntax, application oriented entry checks, availability of sufficient cover and sufficient direct debit maximum amounts etc.) before the direct debit is debited on the RTGS account of B and simultaneously credited on the RTGS account of A.
5	A settlement confirmation (MT 097) is generated in the PM and forwarded to SWIFT.
6a	The settlement confirmation and the original direct debit are matched and the booking time is added to the original direct debit in the SWIFT network.
6b	The direct debit message is forwarded to B.
7	Optional: A can receive a sender notification (MT 012) which also contains the booking time.

2 User Guide for Payments Module (PM)

2.6 Flow of payments

2.6.2 Payment flow

Slide describing the payment flow

The following slide depicts the processing of a direct debit generated by a direct PM participant (A) debiting another direct PM participant (B):

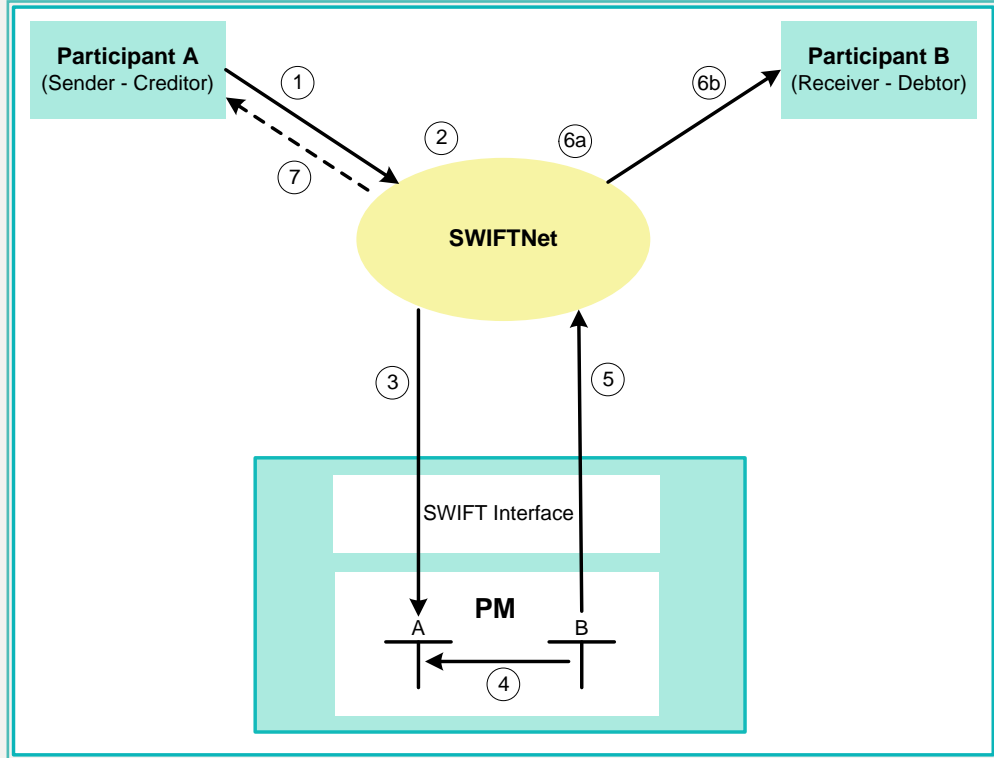

Steps of payment flow

2.6.2.1.2 ... to a participant with indirect access/a participant as an “addressable BIC“

MT /103+ and MT 202/202 COV

The following table describes the processing of a payment from the direct PM participant (A) in favour of an indirect PM participant (C) with indirect access/a participant as an “addressable BIC“ (in the following only the term “indirect participant“ is used):

Step	Description
1	The direct PM participant A (sender) generates a payment in favour of the indirect PM participant C.
2	With reference to the TARGET2 directory, A looks up the PM address for C (BIC of the related direct PM participant B). The direct PM participant A addresses the related direct PM participant B of the indirect PM participant C in the application header of the payment.
3	The payment is temporarily stored by SWIFT.
4	A settlement request (MT 096) with a full copy is generated by SWIFT and forwarded to the PM.
5	The payment has to pass several validations (SWIFT syntax, application oriented entry checks, availability of sufficient cover etc.) before the payment is debited on the RTGS account of A and simultaneously credited on the RTGS account of the related direct PM participant B.
6	A settlement confirmation (MT 097) is generated in the PM and forwarded to SWIFT.
7a	The settlement confirmation and the original payment are matched and the booking time is added to the original payment in the SWIFT network.

2 User Guide for Payments Module (PM)

2.6 Flow of payments

2.6.2 Payment flow

Step	Description
7b	The payment message is forwarded to the related direct PM participant B of the indirect PM participant C.
8	Optional: The sending direct PM participant A can receive a sender notification (MT 012) which also contains the booking time.
9	The direct PM participant B forwards the payment to the indirect PM participant C internally.

2 User Guide for Payments Module (PM)

2.6 Flow of payments

2.6.2 Payment flow

Slide describing the payment flow

The following slide depicts the processing of a payment from the direct PM participant (A) in favour of the indirect PM participant (C):

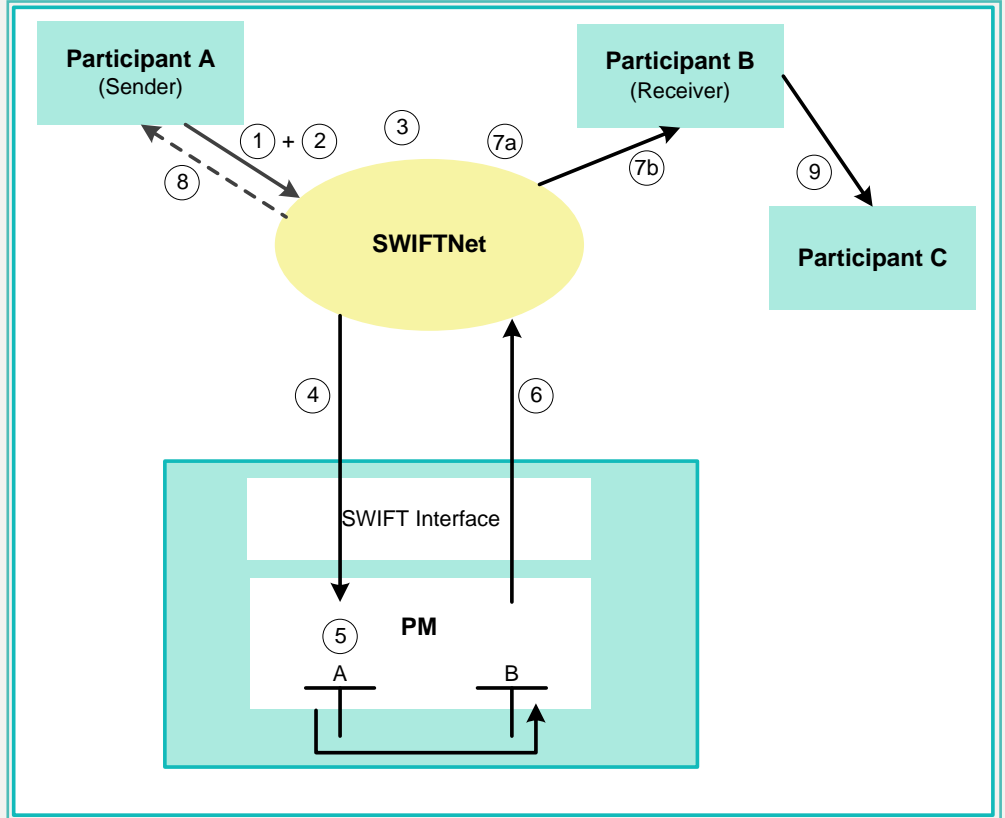

Steps of payment flow

MT 204

The following table describes the processing of a direct debit generated by a direct SWIFT-based PM participant (A) debiting an indirect PM participant (C):

Step	Description
1	The direct PM participant A (sender) generates a direct debit debiting the indirect PM participant C.
2	With reference to the TARGET2 directory, A looks up the PM address for C (BIC of the related direct PM participant B). The direct PM participant A addresses the related direct PM participant B of the indirect PM participant C in the application header of the direct debit.
3	The payment is temporarily stored by SWIFT.
4	A settlement request (MT 096) with a full copy is generated by SWIFT and forwarded to the PM.
5	The payment has to pass several validations (SWIFT syntax, application oriented entry checks, availability of sufficient cover and sufficient direct debit maximum amounts etc.) before the RTGS account of B is debited and the RTGS account of A is credited simultaneously.
6	A settlement confirmation (MT 097) is generated in the PM and forwarded to SWIFT.
7a	The settlement confirmation and the original direct debit are matched and the booking time is added to the original message in the SWIFT network.
7b	The direct debit is forwarded to the related direct PM participant B of the indirect PM participant C.
8	Optional: The sending direct PM participant A can receive a sender notification (MT 012) which also contains the booking time.
9	The direct PM participant B forwards the direct debit to the indirect PM participant C internally.

2 User Guide for Payments Module (PM)

2.6 Flow of payments

2.6.2 Payment flow

Slide describing the payment flow

Note: Internet-based participants can only receive MT 204 but not send.

The following slide depicts the processing of a direct debit generated by a direct PM participant (A) debiting an indirect PM participant (C):

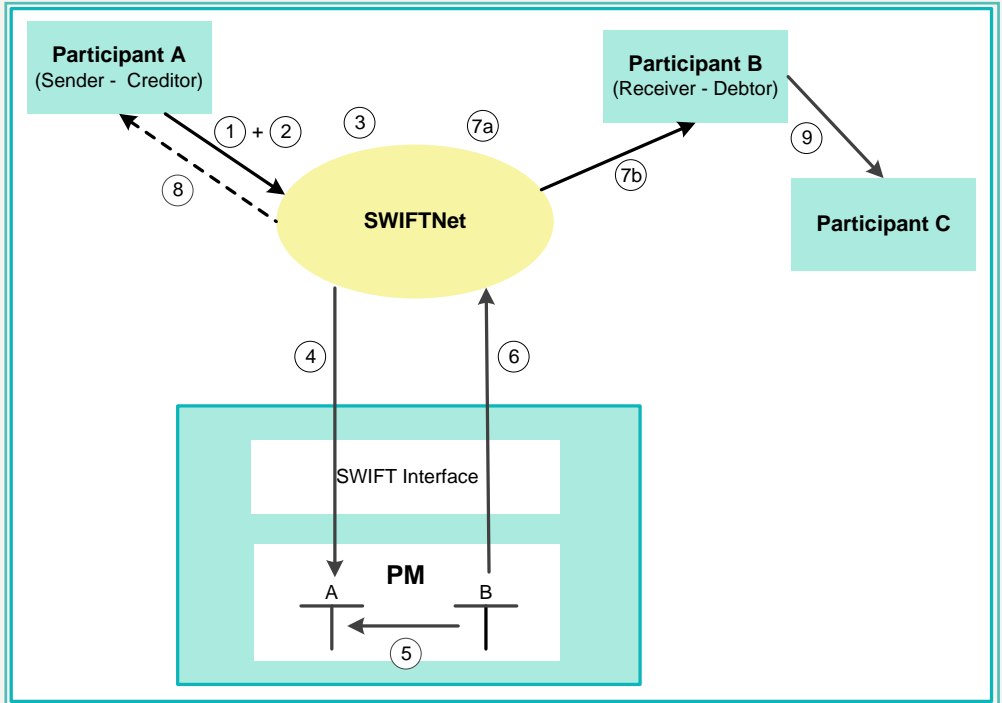

Steps of payment flow

2.6.2.1.3 ... to a HAM account holder

The following table describes the processing of a payment from the direct PM participant (A) in favour of the HAM account holder (E). A direct debit (MT 204) cannot be sent to a HAM account holder.

Note: Such a payment via a “simplified” MT 202 can be a liquidity transfer (transfer of funds between accounts held by the same participant) or an interbank transfer (transfer of funds between accounts of different participants). See also UDFS Book 2 chapter 12.1.4 Transactions processing.

In the following table the example of an interbank transfer is described.

Step	Description
1	The direct PM participant A (sender) generates an interbank transfer in favour of the HAM account holder E.
2	The direct PM participant A takes the dedicated SSP BIC to be used for addressing the payment to HAM account holder E. A uses the specific BIC for transfers to HAM account holders in the header of the SWIFT message with beneficiary Bank E.
3	The payment is temporarily stored by SWIFT.
4	A settlement request (MT 096) with a full copy is generated by SWIFT and forwarded to the PM.
5	The payment has to pass several validations (SWIFT syntax, application oriented entry checks, availability of sufficient cover etc.) before the payment is debited on the RTGS account of the direct PM participant A and simultaneously credited on the RTGS account of the CB of HAM account holder E.
6	PM sends an internal message (MT 202) to HAM. Optional: PM sends a credit notification (MT 910) to the CB.
7a	HAM debits the account of the CB and credits the account of HAM account holder E.
7b	HAM account holder E will receive an MT 202 and optional an MT 910. Optional: the CB receives a debit notification (MT 900).

2 User Guide for Payments Module (PM)

2.6 Flow of payments

2.6.2 Payment flow

Step	Description
8	HAM sends a notification to PM.
9	PM generates a settlement confirmation (MT 097) and sends it to SWIFT. The settlement confirmation and the original payment are matched and the booking time is added to the original payment in the SWIFT network.
10	The payment message is forwarded to PM.
11	Optional: The direct PM participant A can receive a sender notification (MT 012) which also contains the booking time.

2 User Guide for Payments Module (PM)

2.6 Flow of payments

2.6.2 Payment flow

Slide describing the payment flow

The following slide depicts the processing of a payment from the direct PM participant (A) in favour of the HAM account holder (E):

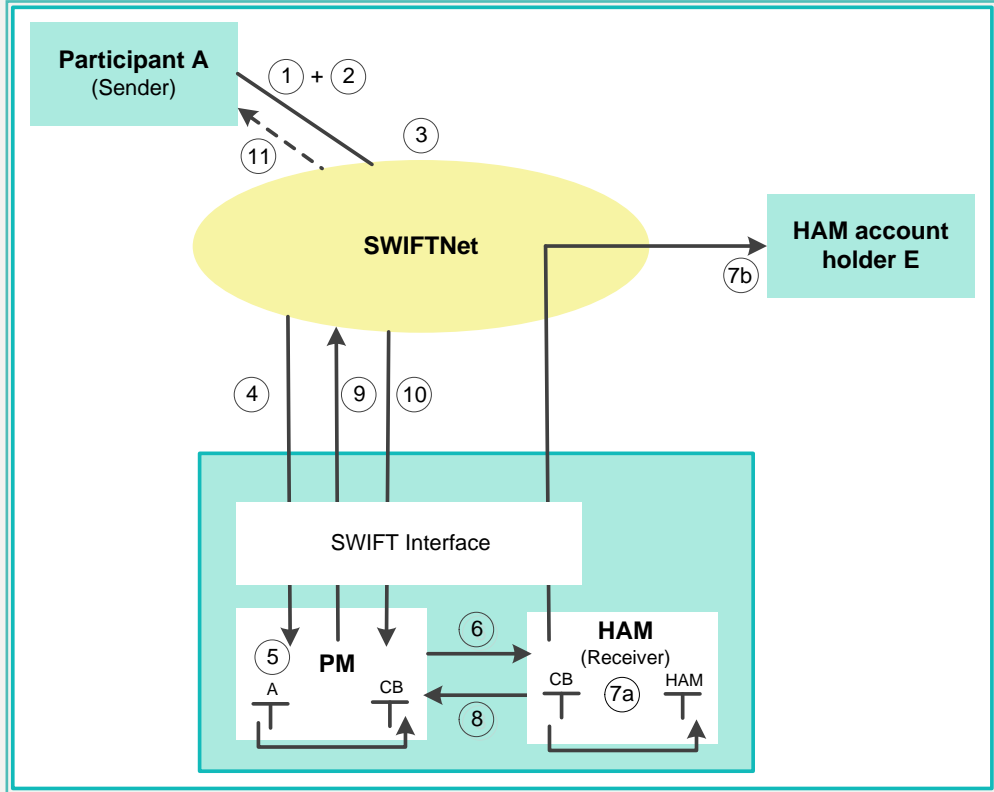

Steps of payment flow

2.6.2.1.4 ... to a CB customer (with an account in HAM)

The following table describes the processing of a payment from the direct PM participant (A) in favour of a CB customer (F) (with an account in HAM). A direct debit (MT 204) cannot be sent to a CB customer.

Step	Description
1	The direct PM participant (A) (sender) generates a payment in favour of the CB customer (F).
2	With reference to the TARGET2 directory, the direct PM participant (A) looks up the BIC to be used for addressing the payment to CB customer (F). A uses the specific BIC of CB in HAM as receiver in the header of the SWIFT message.
3	The payment is temporarily stored by SWIFT.
4	A settlement request (MT 096) with a full copy is generated by SWIFT and forwarded to the PM.
5	The payment has to pass several validations (SWIFT syntax, application oriented entry checks, availability of sufficient cover etc.) before the payment is debited on the RTGS account of the direct PM participant (A) and simultaneously credited on the RTGS account of CB of CB customer (F).
6	PM generates a settlement confirmation (MT 097) and sends it to SWIFT. The settlement confirmation and the original payment are matched and the booking time is added to the original payment in the SWIFT network.
7	Optional: The direct PM participant (A) can receive a sender notification (MT 012) which also contains the booking time.
8	SWIFT sends the stored payment to HAM.
9a	HAM debits the account of the CB of the CB customer (F) and credits the account of the CB customer (F).
9b	HAM sends the payments message to CB customer (F). Optional: HAM sends a credit notification (MT 910) to CB customer (F). HAM sends a debit notification (MT 900) to the CB.

2 User Guide for Payments Module (PM)

2.6 Flow of payments

2.6.2 Payment flow

Slides describing the payment flow

The following slide depicts the processing of a payment from the direct PM participant (A) in favour of the CB customer (F) (with an account in HAM):

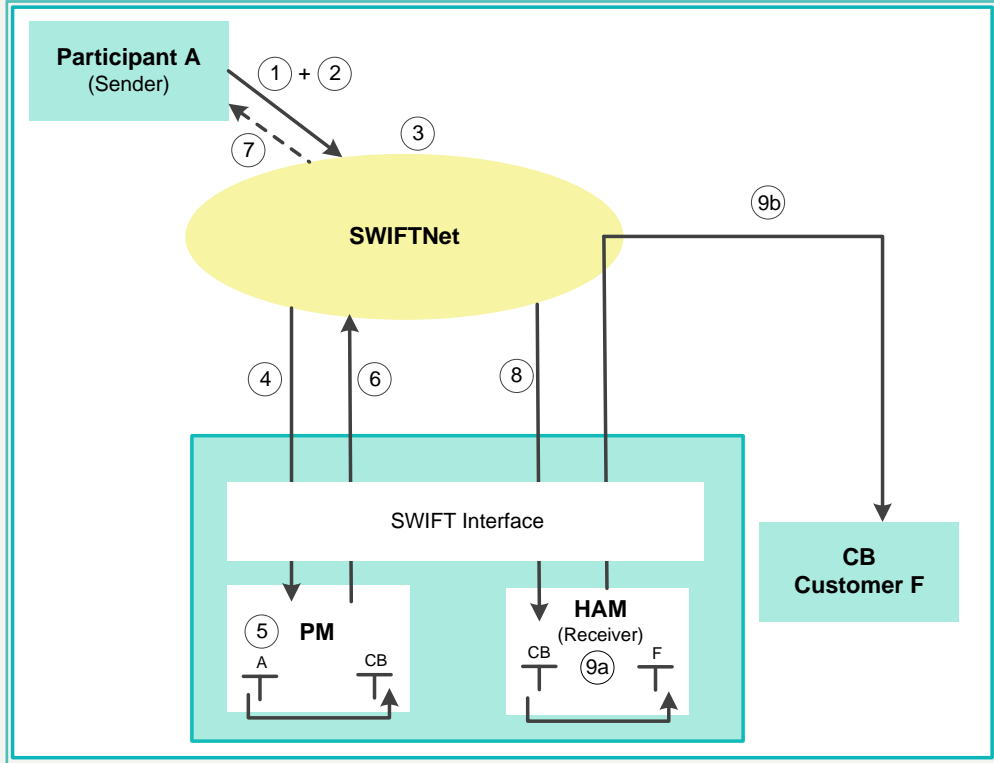

Steps of payment flow

2.6.2.1.5 ... to an account holder with a PHA

The following table describes the processing of a payment from the direct PM participant (A) in favour of the account holder (G) in a proprietary home accounting system of a CB. It is not possible, that a direct debit (MT 204) is sent to an account holder with a PHA.

Step	Description
1	The direct PM participant (A) (sender) generates a payment in favour of the account holder (G) in the proprietary home accounting system.
2	(A) uses the BIC of the CB of account holder (G) as receiver in the header of the SWIFT message.
3	The payment is temporarily stored by SWIFT.
4	A settlement request (MT 096) with a full copy is generated by SWIFT and forwarded to the PM.
5	The payment has to pass several validations (SWIFT syntax, application oriented entry checks, availability of sufficient cover etc.) before the payment is debited on the RTGS account of the direct PM participant (A) and simultaneously credited on the RTGS account of CB of account holder (G).
6	PM generates a settlement confirmation (MT 097) and sends it to SWIFT. The settlement confirmation and the original payment are matched and the booking time is added to the original payment in the SWIFT network.
7	Optional: The direct PM participant (A) can receive a sender notification (MT 012) which also contains the booking time.
8	The payment message is forwarded to the proprietary home accounting system.
9a	The proprietary home accounting system debits the account of the CB of the account holder (G) and credits the account of (G).
9b	It is up to the proprietary home accounting system how account holder (G) is informed about the incoming liquidity.

2 User Guide for Payments Module (PM)

- 2.6 Flow of payments
- 2.6.2 Payment flow

Slide describing the payment flow

The following slide depicts the processing of a payment from the direct PM participant (A) in favour of the account holder (G) in a proprietary home accounting system of a CB:

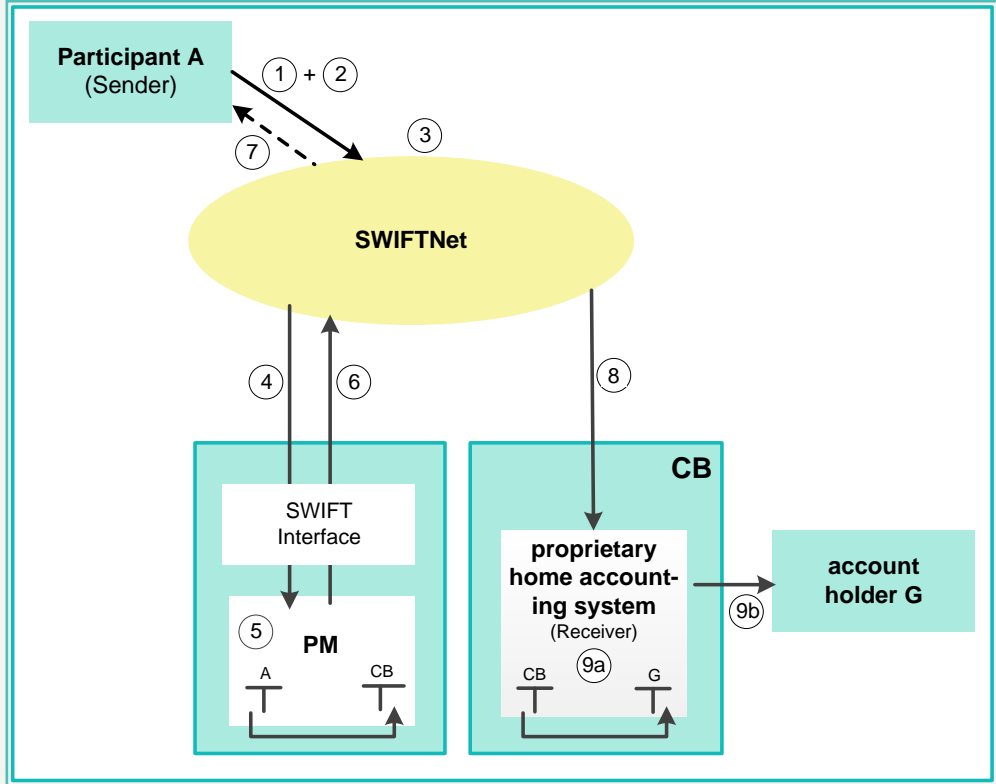

2.6.2.2 Payments received by a PM participant

In the following the processing of a payment in favour of the direct PM participant (A) is described. The different senders of the payment message are:

- another direct PM participant (B)
- a participant with indirect access/a participant as an “addressable BIC“ (C)
- a HAM account holder (E)
- a CB customer (F) (with an account in HAM)
- an account holder (G) with a PHA

Note: If the payment is in favour of a PM participant with indirect access/a participant as an “addressable BIC“ of the direct PM participant (A) one step has to be added after the direct participant has received the payment message: “The direct PM participant (A) passes on the payment to its PM participant with indirect access/a participant as an “addressable BIC“.”

Internet access

The following detailed message flow examples are referring to SWIFT-based participants. If Internet-based participants are affected the following examples have to be amended as follows (see also general flow of messages with Internet-based participants in chapter [2.6.1 Payment Interface, page 99](#)):

If the receiver of the payment is an Internet-based direct PM participant, the receiver of the last outgoing SWIFT message is PM instead of the receiving participant and the Internet-based participant has to request information about the incoming payment via his Internet ICM interface.

Multi-addressee access

Multi-addressee access means that the direct PM participant A has authorised another BIC to receive payments which are settled on the direct PM participant’s RTGS account. Consequently, these payments are directly received by another BIC (ie multi-addressee access BIC). However, the settlement takes place on the account of the respective direct PM participant.

Therefore, if the receiver of the payment is a multi-addressee access BIC, the following examples have to be amended as follows.

“Instead of the direct PM participant A the multi-addressee access BIC is receiving the payments.”

Note: Also the following slides describing the payment flow should be read as “Participant A (receiver)” = multi-addressee BIC.

2.6.2.2.1 ... from a direct PM participant

MT 103/103+ and MT 202/202 COV

The following table describes the processing of a payment the direct PM participant A receives from the direct PM participant B:

Step	Description
1	The direct PM participant B (sender) generates a payment in favour of the direct PM participant A (receiver) and addresses A in the application header of the payment.
2	The payment is temporarily stored by SWIFT.
3	A settlement request (MT 096) with a full copy is generated by SWIFT and forwarded to the PM.
4	The payment has to pass several validations (SWIFT syntax, application oriented entry checks, availability of sufficient cover etc.) before the payment is debited on the RTGS account of the direct PM participant B and simultaneously credited on the RTGS account of direct PM participant A.
5	A settlement confirmation (MT 097) is generated in the PM and forwarded to SWIFT.

Steps of payment flow

2 User Guide for Payments Module (PM)

2.6 Flow of payments

2.6.2 Payment flow

Step	Description
6a	The settlement confirmation and the original payment are matched and the booking time is added to the original payment in the SWIFT network.
6b	The payment message is forwarded to the direct PM participant A.
7	Optional: The direct PM participant B can receive a sender notification (MT 012) which also contains the booking time.

Slide describing the payment flow

The following slide depicts the processing of a payment received by the direct PM participant A from the direct PM participant B:

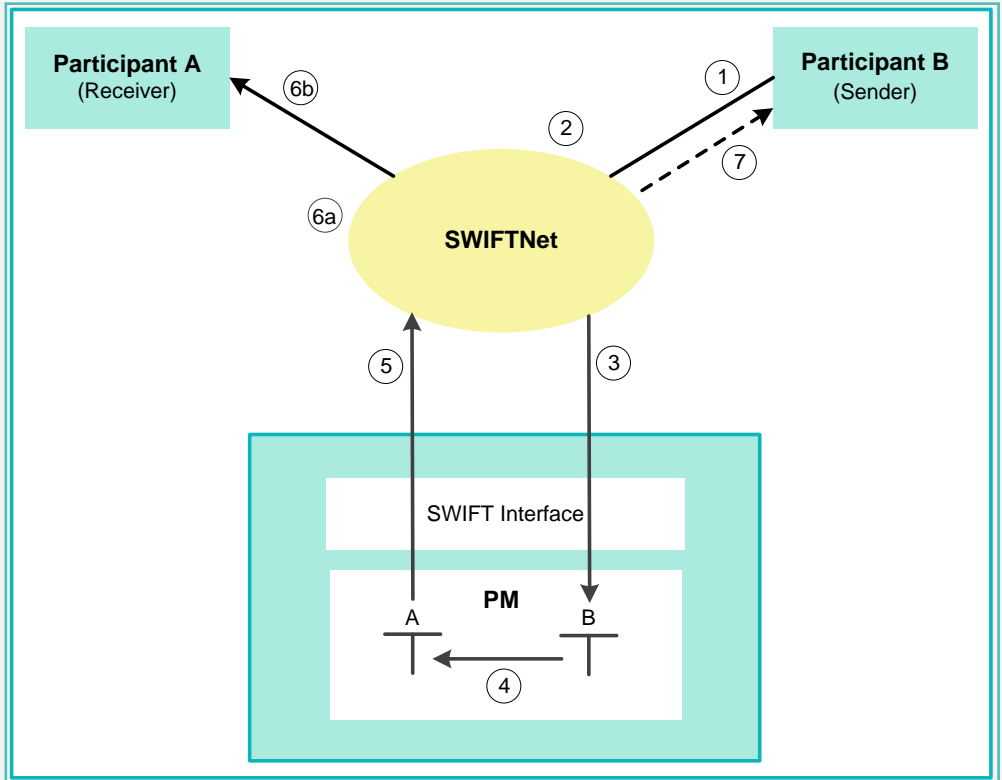

Steps of payment flow

MT 204

The following table describes the processing of a direct debit the direct PM participant A receives from the direct PM participant B:

Step	Description
1	The direct PM participant B (creditor) generates a direct debit debiting the RTGS account of the direct PM participant A (debtor) and addresses A in the application header of the payment.
2	The payment is temporarily stored by SWIFT.
3	A settlement request (MT 096) with a full copy is generated by SWIFT and forwarded to the PM.
4	The payment has to pass several validations (SWIFT syntax, application oriented entry checks, availability of sufficient cover and sufficient maximum amounts for direct debits etc.) before the RTGS account of the direct PM participant A is debited and the RTGS account of the direct PM participant B is credited simultaneously.
5	A settlement confirmation (MT 097) is generated in the PM and forwarded to SWIFT.
6a	The settlement confirmation and the original direct debit are matched and the booking time is added to the original message in the SWIFT network.
6b	The original direct debit is forwarded to the direct PM participant A.
7	Optional: The direct PM participant B can receive a sender notification (MT 012) which also contains the booking time.

2 User Guide for Payments Module (PM)

- 2.6 Flow of payments
- 2.6.2 Payment flow

Slide describing the payment flow

The following slide depicts the processing of a direct debit received by the direct PM participant A from the direct PM participant B:

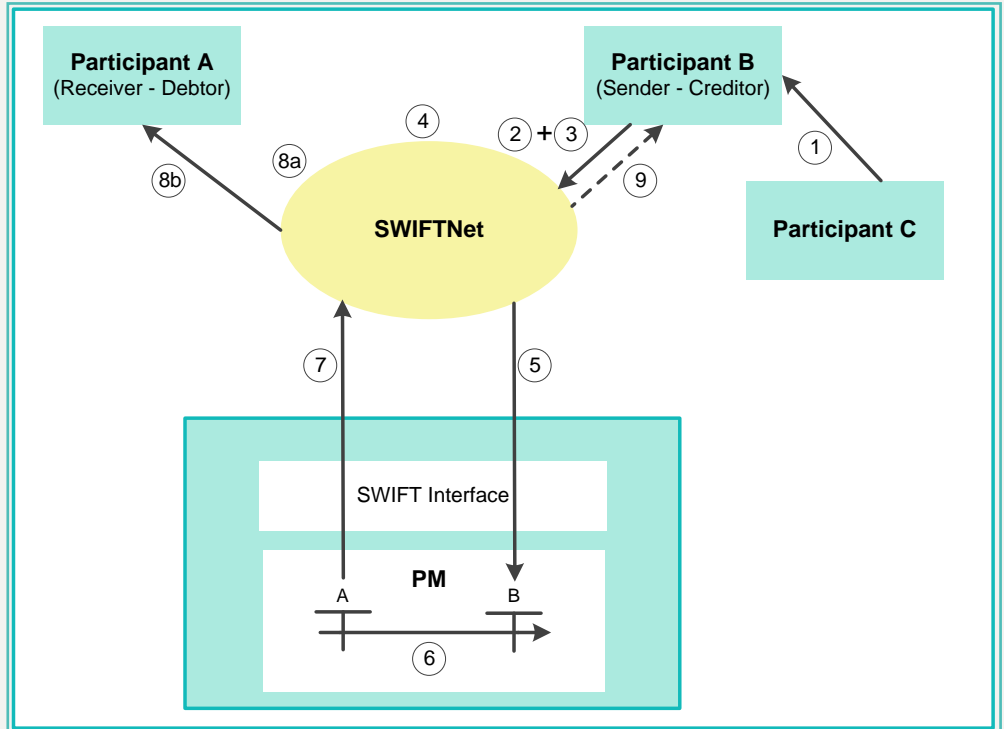

2.6.2.2.2 ... from a participant with indirect access/a participant as an “addressable BIC“

MT 103/103+ and MT 202/202 COV

The following table describes the processing of a payment received by the direct PM participant A from the participant C with indirect access/a participant as an “addressable BIC“ (in the following only the term “indirect participant“ is used):

Step	Description
1	The indirect PM participant C instructs its direct PM participant B to send a payment in favour of the direct PM participant A.
2	The direct PM participant B (sender) generates a payment in favour of the direct PM participant A.
3	With reference to the TARGET2 directory, the direct PM participant B looks up the PM address of the direct PM participant A. The direct PM participant B addresses the direct PM participant A in the application header of the payment.
4	The payment is temporarily stored by SWIFT.
5	A settlement request (MT 096) with a full copy is generated by SWIFT and forwarded to the PM.
6	The payment has to pass several validations (SWIFT syntax, application oriented entry checks, availability of sufficient cover etc.) before the payment is debited on the RTGS account of B and simultaneously credited on the RTGS account of A.
7	A settlement confirmation (MT 097) is generated in the PM and forwarded to SWIFT.

Steps of payment flow

2 User Guide for Payments Module (PM)

- 2.6 Flow of payments
- 2.6.2 Payment flow

Step	Description
8a	The settlement confirmation and the original payment are matched and the booking time is added to the original payment in the SWIFT network.
8b	The payment message is forwarded to the direct PM participant A.
9	Optional: The direct PM participant B can receive a sender notification (MT 012) which also contains the booking time.

Slides describing the payment flow

The following slide depicts the processing of a payment received by the direct PM participant A from the indirect PM participant C:

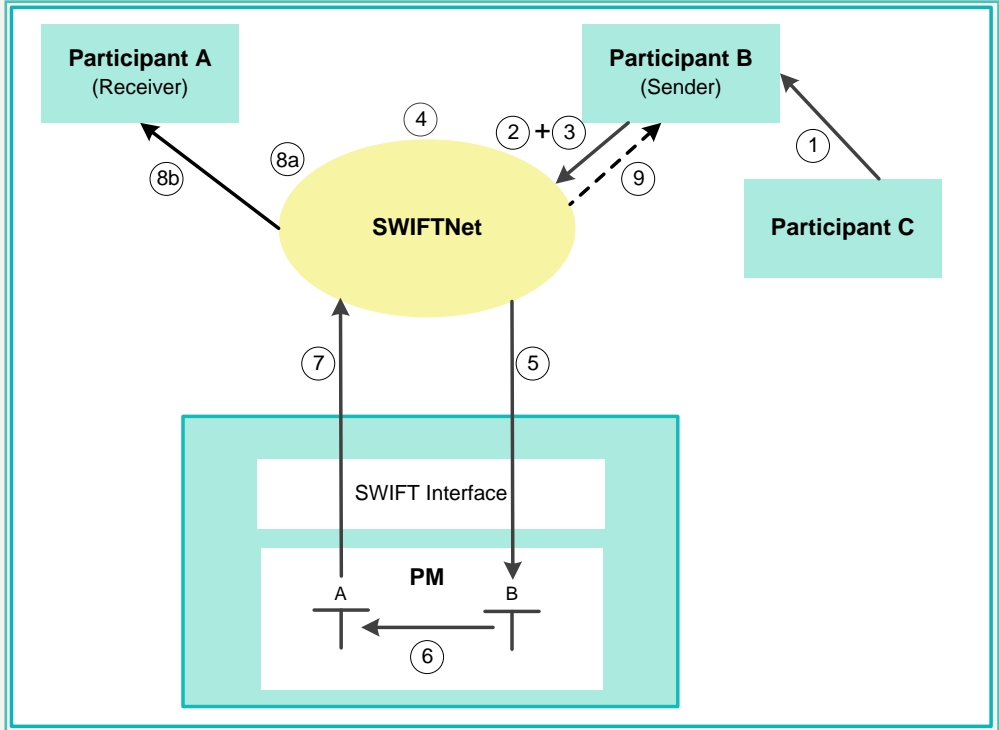

Steps of payment flow

MT 204

The following table describes the processing of a direct debit received by the direct PM participant A from the indirect PM participant C:

Step	Description
1	The indirect PM participant C instructs its direct PM participant B to send a direct debit debiting the RTGS account of the direct PM participant A.
2	The direct PM participant B (creditor) generates a direct debit debiting the RTGS account of the direct PM participant A.
3	With reference to the TARGET2 directory, the direct PM participant B looks up the PM address of the direct PM participant A. The direct PM participant B addresses the direct PM participant A in the application header of the direct debit.
4	The direct debit is temporarily stored by SWIFT.
5	A settlement request (MT 096) with a full copy is generated by SWIFT and forwarded to the PM.
6	The direct debit has to pass several validations (SWIFT syntax, application oriented entry checks, availability of sufficient cover and sufficient maximum amounts for direct debits etc.) before the RTGS account of A is debited and the RTGS account of B is credited simultaneously.
7	A settlement confirmation (MT 097) is generated in the PM and forwarded to SWIFT.
8a	The settlement confirmation and the original direct debit are matched and the booking time is added to the original direct debit in the SWIFT network.
8b	The direct debit message is forwarded to the direct PM participant A.
9	Optional: The direct PM participant B can receive a sender notification (MT 012) which also contains the booking time.

2 User Guide for Payments Module (PM)

2.6 Flow of payments

2.6.2 Payment flow

Slide describing the payment flow

The following slide depicts the processing of a direct debit received by the direct PM participant A from the indirect PM participant C:

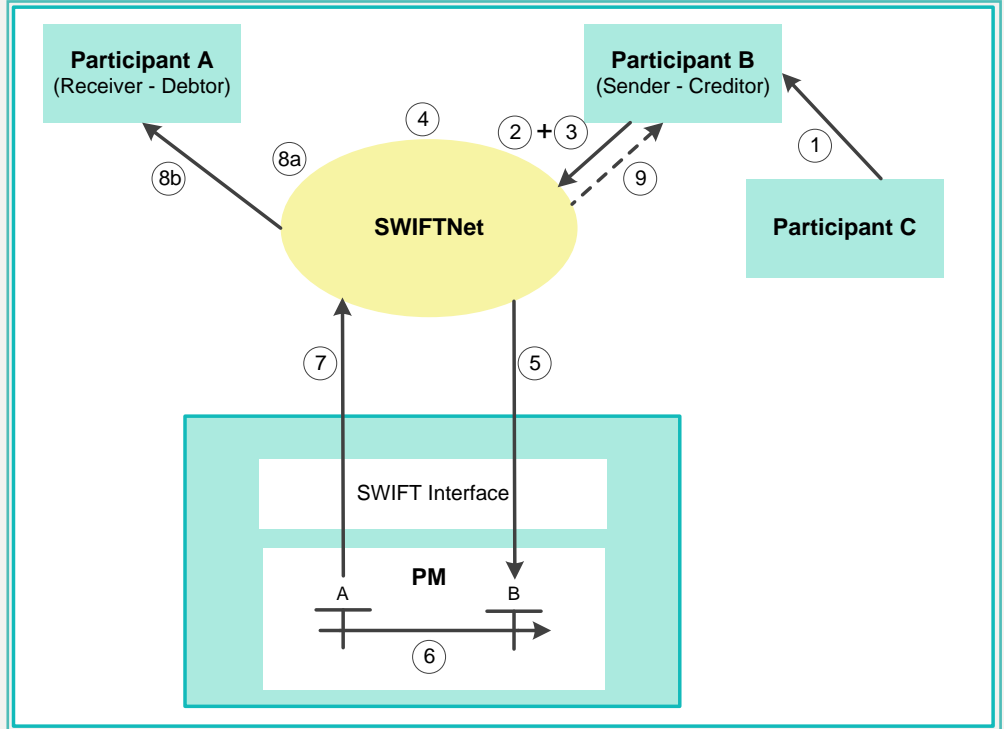

Steps of payment flow

2.6.2.2.3 ... from a HAM account holder

“Simplified“ MT 202 (liquidity transfer)

The following table describes the processing of a payment received by the direct PM participant (A) from the HAM account holder (E).

Step	Description
1	The HAM account holder (E) generates a liquidity transfer in favour of the direct PM participant (A).
2	HAM debits the account of HAM account holder (E) and credits the account of the CB of HAM account holder (E).
3	Optional: The HAM account holder (E) receives an MT 900. The CB receives an MT 910.
4	HAM sends an internal message (MT 202) to PM.
5	The payment is debited on the RTGS account of the CB and simultaneously credited on the RTGS account of the direct PM participant (A).
6	PM sends a notification to HAM.
7	The payment message is sent to the direct PM participant (A). Optional: PM sends an MT 900 to the CB.

2 User Guide for Payments Module (PM)

2.6 Flow of payments

2.6.2 Payment flow

Slides describing the payment flow

The following slide depicts the processing of a payment received by the direct PM participant (A) from the HAM account holder (E):

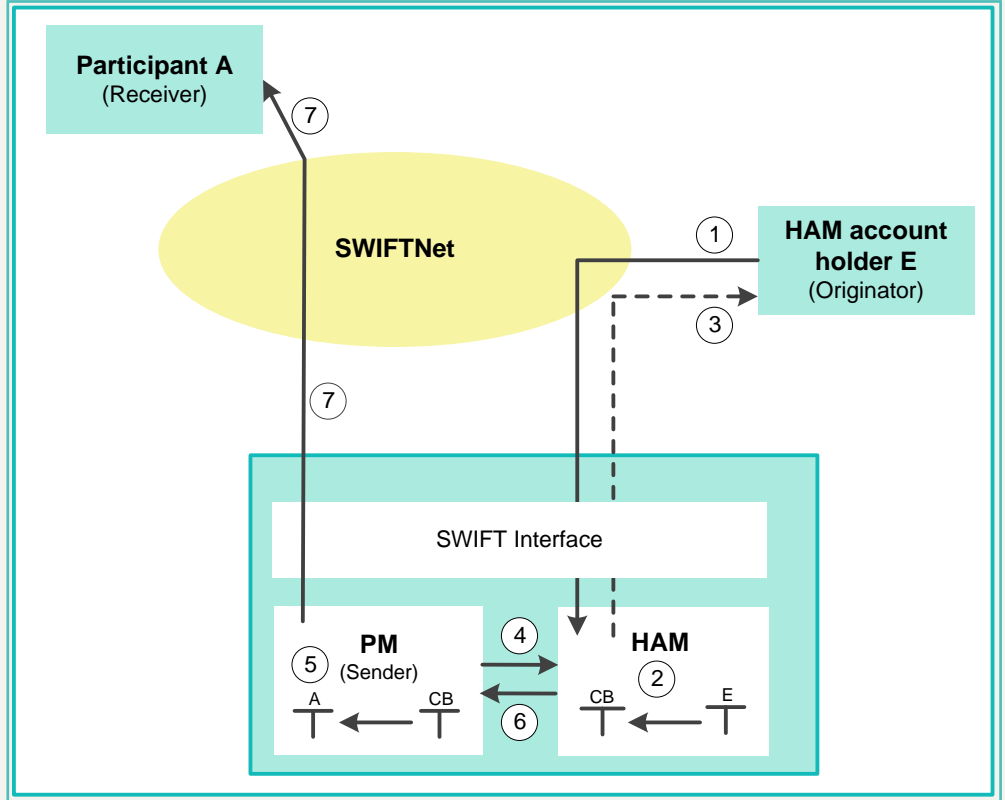

Steps of payment flow

2.6.2.2.4 ... from a CB customer (with an account in HAM)

The following table describes the processing of a payment received by the direct PM participant (A) from the CB customer (F) (with an account in HAM).

Step	Description
1	The CB customer (F) generates a payment in favour of the direct PM participant (A).
2	HAM debits the account of CB customer (F) and credits the account of the CB of CB customer (F).
3	Optional: HAM sends a debit notification (MT 900) to CB customer (F). HAM sends a credit notification (MT 910) to the CB.
4	HAM (sender) generates a payment in favour of the direct PM participant (A).
5	The payment is temporarily stored by SWIFT.
6	A settlement request (MT 096) with a full copy is generated by SWIFT and forwarded to the PM.
7	The payment has to pass several validations (SWIFT syntax, application oriented entry checks, availability of sufficient cover etc.) before the payment is debited on the RTGS account of CB of CB customer (F) and simultaneously credited on the RTGS account of the direct PM participant (A). On an optional basis the debit notification (MT 900) is sent to the CB.
8	PM generates a settlement confirmation (MT 097) and sends it to SWIFT. The settlement confirmation and the original payment are matched and the booking time is added to the original payment in the SWIFT network.
9	The payment message is forwarded to the direct PM participant (A).

2 User Guide for Payments Module (PM)

2.6 Flow of payments

2.6.2 Payment flow

Slides describing the payment flow

The following slide depicts the processing of a payment received by the direct PM participant (A) from the CB customer (F) (with an account in HAM):

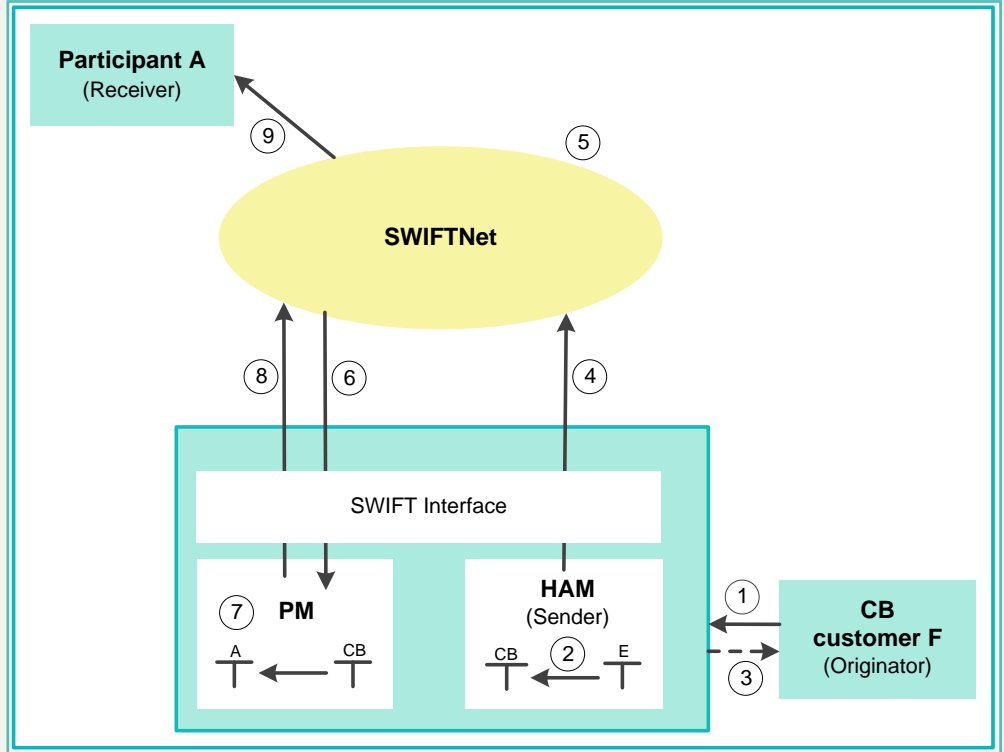

Steps of payment flow

2.6.2.2.5 ... from a participant with a PHA

The following table describes the processing of a payment received by the direct PM participant (A) from the account holder (G) in a proprietary home accounting system of a CB.

Step	Description
1	The account holder (G) (Originator) generates a payment in favour of the direct PM participant (A). Note: It is up to the proprietary home accounting system to define the rules for the account holder G to send the payment.
2	The proprietary home accounting system debits the account of the account holder (G) and credits the account of the CB of the account holder (G).
3	The proprietary home accounting system (sender) generates a payment in favour of the direct PM participant (A).
4	The payment is temporarily stored by SWIFT.
5	A settlement request (MT 096) with a full copy is generated by SWIFT and forwarded to the PM.
6	The payment has to pass several validations (SWIFT syntax, application oriented entry checks, availability of sufficient cover etc.) before the payment is debited on the RTGS account of the CB of the account holder (G) and simultaneously credited on the RTGS account of the direct PM participant (A).
7	PM generates a settlement confirmation (MT 097) and sends it to SWIFT. The settlement confirmation and the original payment are matched and the booking time is added to the original payment in the SWIFT network.
8	The payment message is forwarded to the direct PM participant (A).
9	Optional (depending on the functionality of PHA): The account holder (G) can receive a sender notification (MT 012) which also contains the booking time.

2 User Guide for Payments Module (PM)

2.6 Flow of payments

2.6.2 Payment flow

Slides describing the payment flow

The following slide depicts the processing of a payment received by the direct PM participant (A) from the account holder (G) in a proprietary home accounting system of a CB:

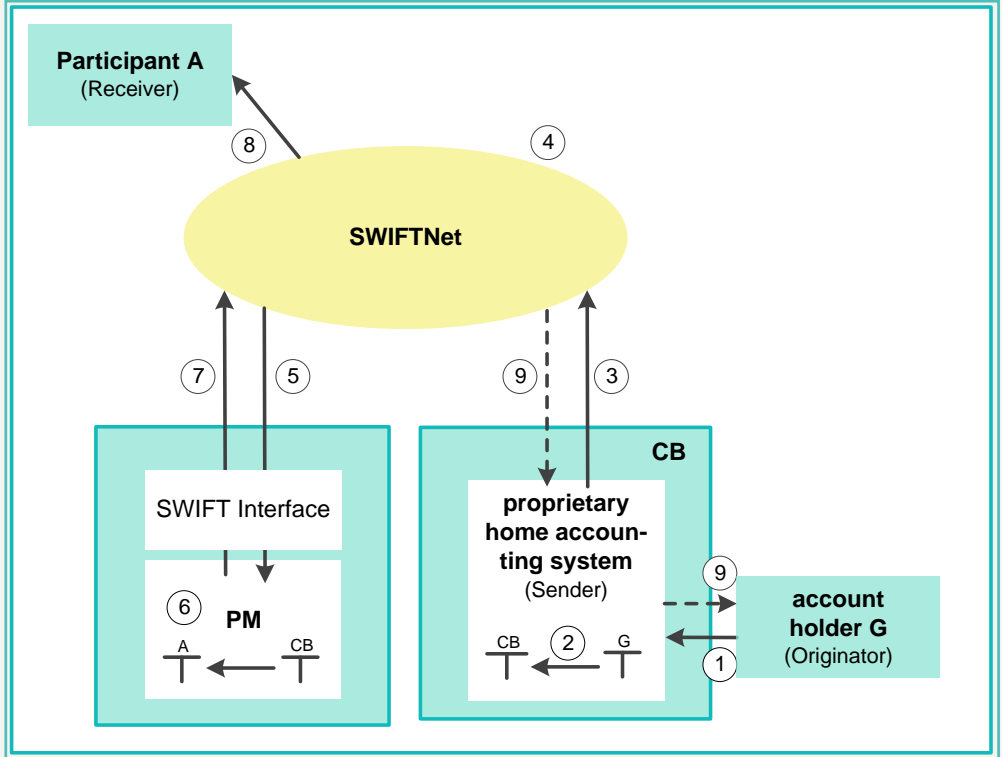

2.6.3 Rejection of payments

2.6.3.1 General information

A payment is rejected and returned to the sender (a payment is returned by an MT 019 only in case of a SWIFT-based participant as sender, in case of an Internet-based participant as sender, the rejection is only visible via ICM) in case of:

- an incorrect payment
- a participant has been excluded from the PM and the related CB does not confirm the payments submitted by the excluded participant
- a participant has been excluded from the PM and the related CB does not confirm the payments sent in favour of the excluded participant
- a lack of liquidity and/or limit position(s) at the end of the payment processing
- reject time is reached (Latest Debit Time Indicator - option a)
- a direct debit for which the special conditions are not fulfilled

The sender of a rejected payment receives an abort notification (MT 019) quoting the reason for the rejection. The rejected payment can be positively identified by quoting the message input reference (MIR) and the optional message user reference (MUR) of the original payment.

The error codes for possible rejections are listed in chapter [9.5.2 Error codes, page 629](#).

Overview

Information for the sending participant via FIN (only for SWIFT-based participants)

Information in the ICM

The information on payments rejected at the end of the payment processing is available for both the sending and the receiving participant. Incorrect payments are also displayed for the sending and the receiving participant.

As the ICM access is still possible for excluded participants, payments in favour of an excluded participant are also available for both the sending and the excluded receiving participant.

2.6.3.2 Incorrect payments

General aspects

Syntactical validations are conducted in

- the SWIFT network and
- in PM

to obtain high quality data in PM.

In addition, specific standards for PM, HAM and PHA are validated in PM. These entry validations are reflected in the list of error codes described in chapter [9.5.2 Error codes, page 629](#).

In case of Internet-based participants the ICM will perform the SWIFT validations based on the entered message data.

Payments will be rejected if they are not made up according to these standards.

2.7 Processing of payments

2.7.1 Entry disposition

2.7.1.1 General remarks

Basics

In recent years, the management of liquidity and the improvement of liquidity efficiency, especially in RTGS systems, have become of utmost importance.

2 User Guide for Payments Module (PM)

2.7 Processing of payments

2.7.1 Entry disposition

Offering a broad set of liquidity management features helps to fulfil the objectives of TARGET2. These features may:

- give participants the tools to achieve a flexible and need-based control of their payment flow, thereby limiting possible liquidity risks
- result in faster settlement, with a reduced amount of liquidity
- help to avoid potential systemic risk owing, eg to gridlock situations
- increase transparency to participants
- help, all in all, to achieve a higher degree of efficiency

The features are implemented in the PM on a flexible and optional basis. This is to allow each participant to meet its individual needs, ie the PM participants can simply “switch off” those tools they do not need.

Objective for settlement of transactions

The aim of the processing in the PM is the fast and liquidity-saving gross settlement of transactions with the following characteristics:

- Cover for single payments or the balance of a group of payments
- Settlement in central bank money
- Immediate, irrevocable booking of settled payments

Influencing factors

The payment processing in the PM is influenced by the following factors:

- Liquidity available on the RTGS account
- Setting limits
- Used priority
- Order of payments submitted
- Opposing transactions and synchronisation of payments submitted
- Set execution time

Basic principles

The following principles apply to the entire payment process in the PM:

- Every payment should be marked as “normal“ or “urgent“ or “highly urgent“. If no priority class is selected, payments will be handled as normal payments.
- Attempt to settle single or group of transactions immediately after their submission, with the exception of payments with an “Earliest Debit Time Indicator“. These payments are included in the settlement process from the present time.
- Offsetting payments are used to save liquidity (bilateral optimisation mechanism).
- Payments that are finally executed are immediately posted to the RTGS account of the sender (debit: MT 103/103+/202/202 COV; credit: MT 204) and the receiver (credit: MT 103/103+/202/202 COV; debit: MT 204). Only payments still not executed may be revoked.
- Queuing of transactions, which cannot be settled immediately, according to their type in different queues (highly urgent queue, urgent queue, normal queue).
- Continuous attempt to settle transactions in the queues.
- The entry disposition and the optimisation procedures for queues can run at the same time.

2.7.1.2 Settlement of payments in the entry disposition

- For highly urgent payments the FIFO-principle applies. Urgent and normal payments will not be settled in the case that highly urgent payments are queued. The only exception is that payments with lower priority can be executed before if - and only if - this will allow an offsetting transaction to be settled and the overall effect of this offsetting will be a liquidity increase for that participant.
- For urgent payments the FIFO-principle applies, too. Normal payments will not be settled if urgent payments are queued. The only exception is that payments with a lower priority can be executed before if - and only if

Principles of entry disposition

2 User Guide for Payments Module (PM)

2.7 Processing of payments

2.7.1 Entry disposition

- this will allow an offsetting transaction to be settled and the overall effect of this offsetting will be a liquidity increase for that participant.

- Normal payments are processed according to the “FIFO by-passing” principle. To save as much liquidity as possible, the FIFO-principle would not be the optimal one; ie normal payments submitted may be executed even if other normal payments are still in the queue (provided that the balance on the RTGS account is sufficient).

“FIFO by-passing”

During entry disposition “FIFO by-passing” for payments with normal priority means that they may be processed immediately (independent from other queued normal payments submitted at an earlier time) and can therefore breach FIFO order, under the condition that the balance on the RTGS account is sufficient.

Offsetting transactions

The entry disposition takes offsetting transactions into account. The liquidity of the PM participant is used to cover balances. In addition, in the case of normal payments the defined limits are considered.

The following table shows which transactions are taken into account during the entry disposition by the account of the debtor and/or the creditor:

Debtor	Creditor
Single submitted payment only	All offsetting highly urgent/urgent and normal transactions in the queues

Debtor: That is for MT 103, MT 103+, MT 202/202 COV and comparable XML-Messages the sender of the message and for MT 204 (also comparable XML-Messages) the receiver of the message.

Creditor: That is for MT 204 (also comparable XML-Messages) the sender of the message and for MT 103, MT 103+, MT 202/202 COV and comparable XML-Messages the receiver of the message.

Unsuccessful entry disposition

If the submitted payment cannot be settled in the entry disposition, it will be placed into the highly urgent, urgent or normal queue, depending on the payment type.

2 User Guide for Payments Module (PM)

- 2.7 Processing of payments
- 2.7.1 Entry disposition

Note: Liquidity transfers will not be placed into a queue. They will be rejected instead with appropriate error code (eg P67/T67 or P68/T68) in case liquidity is not sufficient or none of the above mentioned criteria for FIFO bypassing can be met.

Sequence of settlement checks

The following diagram shows the different settlement checks:

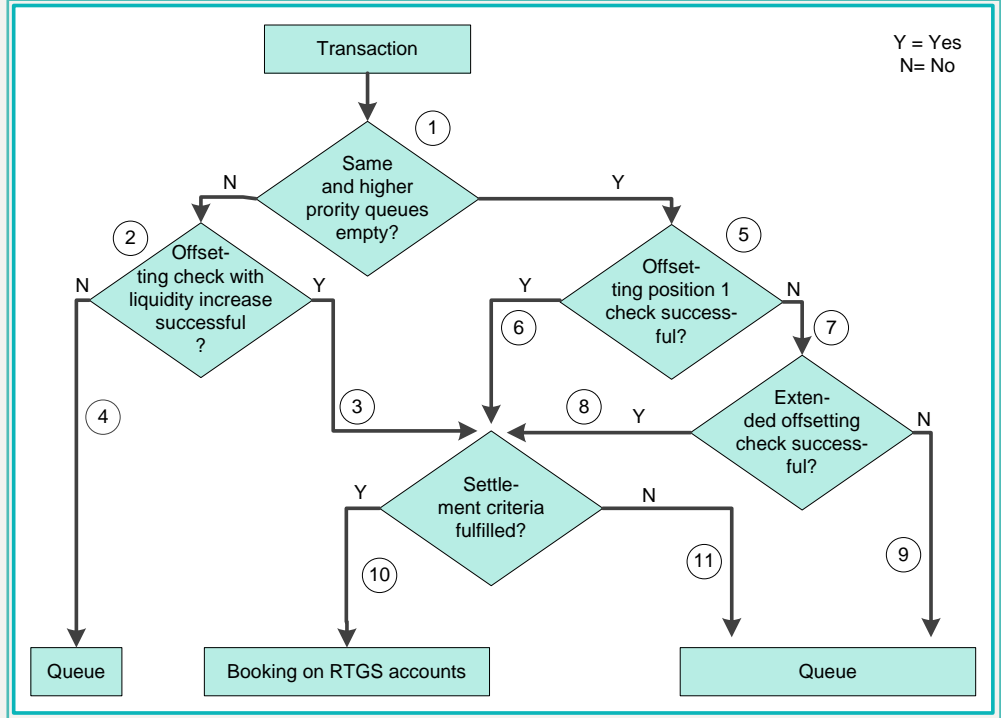

Step	Description
1	The system checks whether there are already operations of an equal or higher priority level in the queue (exception: if the submitted transaction is a normal one, it is not checked whether the "normal" queue is empty, because the FIFO principle can be breached for normal payments).
2	If the highly urgent and urgent queue is not empty, a bilateral algorithm named

2 User Guide for Payments Module (PM)

2.7 Processing of payments

2.7.1 Entry disposition

Step	Description
	“offsetting check with liquidity increase” takes place. This algorithm is only successful if offsetting payments from the receiver are available and the sender will afterwards have an increased liquidity position.
3	If offsetting transactions exist, it is checked if the submitted transaction fulfils the other settlement criteria (ie bilateral or multilateral limit and liquidity reservations not breached).
4	If no such offsetting transactions exist, the transaction is put in the queue.
5	If the highly urgent and the urgent queue is empty, a bilateral algorithm, the “offsetting position 1 check” takes place. This algorithm is only successful if offsetting payments on top of the receiver’s queue are available.
6	If the offsetting check is successful, it is checked if the submitted transaction fulfils the other settlement criteria (ie bilateral or multilateral limit and liquidity reservations not breached).
7	If the offsetting check is not successful, a bilateral algorithm named “extended offsetting check” takes place. This algorithm is only successful if offsetting payments from the receiver (not only on top of his queue) are available and the receiver will afterwards have an increased liquidity position.
8	If the extended offsetting check is successful, it is checked if the submitted transaction fulfils the other settlement criteria (ie bilateral or multilateral limit and liquidity reservations not breached).

2 User Guide for Payments Module (PM)

2.7 Processing of payments

2.7.1 Entry disposition

Step	Description
9	If the extended offsetting check is not successful, the transaction is put in the queue.
10	If the other settlement criteria (ie bilateral or multilateral limit and liquidity reservations not breached) are fulfilled, then the operation(s) is (are) settled on the RTGS accounts.
11	<p>If the other settlement criteria are not fulfilled, then the operation(s) is (are) put in the queue until sufficient liquidity is available and the other settlement criteria are fulfilled (details on the dissolution of the queues are given in chapter 2.7.3 Dissolution of payment queue, page 155).</p> <p>If there is not sufficient liquidity available and/or the other settlement criteria are not fulfilled till the time of covering is reached, the payments not settled will be rejected.</p>

2 User Guide for Payments Module (PM)

- 2.7 Processing of payments
- 2.7.1 Entry disposition

Bilateral optimisation mechanism

The following diagram shows the different types of the optimisation mechanism:

Step/type	Condition	Diagram	Result
<p>②</p> <p>Offsetting with liquidity increase</p>	<p>offsetting transaction at position 1 in the queue B with an amount higher than the transaction A => B</p>		<p>transactions are settled if position is covered.</p>
<p>⑤</p> <p>Offsetting position 1</p>	<p>offsetting (highly) urgent transaction at position 1 in the queue of B</p>		<p>transactions are settled if position is covered.</p>
<p>⑦</p> <p>Extended offsetting</p>	<p>offsetting transaction in the queue of B with an amount smaller than the transaction A => B</p>		<p>transactions are settled if position is covered.</p>

H(Ut) = highly urgent or urgent payment
Nt = Normal payment

Additional explanations

Offsetting with liquidity increase: A's queue contains operations which, due to their priority and/or order in FIFO, should be processed before the new operation. However, it is attempted to settle the new operation by seeking an offsetting operation with a higher amount. Indeed, if this offsetting is successful, A will have more liquidity than before, and the chances to settle the operations with a higher priority and/or order in FIFO will increase.

The outcome of the "offsetting position 1" check may be positive even in the absence of offsetting transactions, provided that A's balance is sufficient to cover the amount of the operation.

Offsetting with liquidity increase

Offsetting position 1

2.7	Processing of payments
2.7.2	Comprehensive queue management

Extended offsetting

Extended offsetting: the queue of the counterpart B - creditor of the new payment - is checked whether there are (highly) urgent or normal payments in favour of A and which can be settled as offsetting transaction to the payment of A. If the result is a liquidity increase for B the offsetting payments are settled although a breach of the FIFO-principle/priorities (eg operations with higher priority are still waiting in the queue) take place. Comparable to the “offsetting with liquidity increase“, this time from B’s perspective. In the consequence B will have more liquidity after the settlement than before and the chances to settle the operations with a higher priority and/or order in FIFO will increase.

Rejection during end-of-day processing

If queued payments can not be cleared during the ongoing optimisation procedures and are still queued by the end of the day due to lack of liquidity (including urgent or highly urgent reservation of liquidity) or insufficient limits, these payments will be rejected during end-of-day processing.

Interventions on queued payments

As long as a payment is not settled, the sending participant (direct participant, not the multi-addressee sender; exception see below) has the ability to change the relevant parameters of this payment.

Four different control options are offered:

- Ability to change the payment type of a queued transaction = change of priority (exception MT 204: the receiving participant (debtor) has the ability to change priority and exception for highly urgent payments)
- Re-ordering of queued transactions (exception MT 204: the receiving participant (debtor) has the ability to re-order)
- Changing the set execution time (if defined before sending to the SSP)
- Revocation of a queued transaction (not yet settled payments may be revoked via ICM at any time during the day trade phase). This includes MT 202 sent to the Ancillary System Interface in procedure 1 and 6.

2.7.2 Comprehensive queue management

2 User Guide for Payments Module (PM)

- 2.7 Processing of payments
- 2.7.2 Comprehensive queue management

Note: Although still present in TARGET2, procedure 1 should not be used anymore since it is limited to daylight processing only. For details please refer to the Guideline on TARGET2 and its amendments (<https://www.ecb.europa.eu/ecb/legal/1003/1349/html/index.en.html>).

Those features are necessary to enable direct PM participants to react on changed liquidity conditions during the day.

The following rules apply in principle:

- Interventions must be made in the ICM. A description of individual processes can be found in the ICM User Handbook.
- Individual or several payment orders together can be modified at the same time.
- The ICM shows receipt and execution or non-execution of a modified order or a revocation.

In case of intervention at transaction level by a direct PM participant, processes are started to resolve the queues.

The following table shows the options for changing the payment types and those participants in the PM allowed to use the different possibilities:

Payment type			Participants allowed to use the option
Highly urgent transactions	Urgent transactions	Normal transactions	
	→		<ul style="list-style-type: none">• Credit institutions• Ancillary systems• Central banks
		←	

It is not possible to change a highly urgent priority.

The payment priority can be changed at any time during the business day. The sender and the receiver can see the changed payment type in the ICM.

Basics

Changing the payment type (priority)

Visibility incoming and outgoing queue

2 User Guide for Payments Module (PM)

- 2.7 Processing of payments
- 2.7.2 Comprehensive queue management

Effect of change priority

The modified payment:

- keeps the original submission time
- is placed in the queue according to the (new) priority and the (old) submission time
- is processed according to the regulations of the (new) priority

The effects of changing the payment type are:

Action	Effect
Change of the first queued urgent payment into a normal payment	<ul style="list-style-type: none">• If no highly urgent payment is queued immediate attempt to settle the remaining urgent payments following the FIFO-principle.• If highly urgent payments are queued no immediate attempt to settle any urgent payments.
Change of a normal payment into an urgent payment	<ul style="list-style-type: none">• If the payment changed from normal to urgent moves at the top of the queued urgent payments and no highly urgent payments are queued, immediate attempt to settle urgent payments following the FIFO-principle.• Otherwise no immediate attempt to settle urgent payments.

Re-ordering the queued transactions

The sender (except MT 204: receiver = debtor) can change the queue position for an individual or for a sequence of payments. The selected payment or sequence of payments can be placed:

- to the top of the queued payments with the same payment type
- to the end of the queued payments with the same payment type

2 User Guide for Payments Module (PM)

2.7 Processing of payments

2.7.2 Comprehensive queue management

The re-ordering can be done at any time during the business day. The sender and the receiver can see the changed order in the queue in the ICM.

The following table shows the effect of changing the order in the queue:

Action	Effect on payment management
Moving a highly urgent payment to the top of the queued highly urgent payments	Immediate check whether payments can be executed
Moving a highly urgent transaction from the top to the end of the queued highly urgent payments	
Moving an urgent payment to the top of the queued urgent payments and no highly urgent payment is queued	
Moving an urgent payment from the top to the end of the queued urgent payments and no highly urgent payment is queued	
Moving a highly urgent payment which is not at the top of the queued highly urgent payments to the end	It is taken into account during the next settlement process - no immediate attempt to settle.
Moving an urgent payment which is not at the top of the queued urgent payments to the end	
Moving a normal transaction to the top or the end of the queued normal payments	

Note: The re-ordering of queued transactions is available for all payment types including highly urgent payments.

Payments can include a time that indicates when they should be settled (transactions with an “Earliest Debit Time Indicator”).

Payments can include a time that indicates when they should have been settled (transactions with a “Latest Debit Time Indicator”).

Changing the execution time

2 User Guide for Payments Module (PM)

- 2.7 Processing of payments
- 2.7.2 Comprehensive queue management

Effect of changing the execution time

The execution time (from/till) may be changed in the ICM (advanced or postponed). The change has no impact on the payment processing, but on the queue management as the time indication only supports the direct PM participant's queue management. The ICM shows the changed execution time.

Changing the execution time has the following impact on the queue management:

Action	Effect on queue management
Deleting the execution time of a highly urgent transaction ("from")	Immediate settlement attempt, if the payment reaches the top of the queued highly urgent payments.
Deleting the execution time of an urgent transaction ("from")	Immediate settlement attempt, if the payment reaches the top of the queued urgent payments and no highly urgent payments are queued.
Deleting the execution time of a normal transaction	Including the payment in the next settlement process.
Changing the execution time of a highly urgent, urgent or normal transaction	Including the payment from the new indicated time.

Event-oriented resolving

2.7.3 Dissolution of payment queue

2.7.3.1 Settlement of queued (highly) urgent payments

The (highly) urgent queue is resolved in an event-oriented way starting with the transaction at the top.

The following table describes the origin of possible events:

Events	by ...
Liquidity increase	<ul style="list-style-type: none">• Incoming transactions• Liquidity transfer from PHA at CB/from HAM• Increase of credit line (if applicable)
Intervention on queue level	<ul style="list-style-type: none">• If the transaction on the top of the (highly) urgent queue is changed (change of order, change of priority, revocation)

Resolving the (highly) urgent queue and entry disposition is handled in the same way. If a single highly urgent or urgent payment cannot be settled, it will remain in the queue (at maximum till the end of the business day).

The (highly) urgent queue is continuously resolved by the sequentially run of algorithms for the resolving of queued normal payments.

For optimisation of the processing of highly urgent ancillary system transactions on the sub-accounts of the settlement banks a special algorithm is used (algorithm 5). It can be seen as an exception of the below described algorithms for settlement of queued normal payments.

Continuously resolving

Optimisation for the processing on sub-accounts

2.7	Processing of payments
2.7.3	Dissolution of payment queue

2.7.3.2 Settlement of queued normal payments

Principles

The normal queue is continuously resolved by including highly urgent and urgent payments not yet settled. There are four different algorithms available:

- All-or-nothing optimisation (algorithm 1)
- Partial optimisation (algorithm 2)
- Multiple optimisation (algorithm 3)
- Partial optimisation with ancillary system (algorithm 4)

The single algorithms are used either sequentially or according to the situation. This is to respond in a flexible way to changed liquidity conditions during the operating day.

Algorithms 1, 2, 3 or 4 can run in parallel to the “entry disposition“ of PM, which means that payments entering the system after the start of whatever algorithm can be settled immediately if the positions and limits of the participants concerned are compatible with both the settlement of these payments and the settlement of payments taken into account in the current optimisation. Contrarily, two algorithms cannot run in parallel to each other.

Sequence of run

During the business day the algorithms run sequentially,

- while there is no pending simultaneous multilateral settlement of an ancillary system:
 - algorithm 1 then algorithm 2 then algorithm 3 ...
 - if algorithm 2 succeeds then two algorithm schedule options are in place, ie either algorithm 3 runs always after algorithm 2 or algorithm 1 runs again. The switch of the algorithm schedule option in the responsibility of the SSP operational team.
- while there is a pending simultaneous multilateral settlement of an ancillary system:
 - algorithm 4

2 User Guide for Payments Module (PM)

2.7 Processing of payments

2.7.3 Dissolution of payment queue

The algorithms run in a flexible way by defining a parametrable time lag between execution of different algorithms to have a minimum interval between two runs of algorithms. The temporal sequence is automatically controlled by the system. Manual intervention is possible for the SSP operational team.

During a running algorithm a payment is “blocked“. That means it cannot be re-ordered, revoked, etc. If the payment becomes final during the run of the algorithm the instruction will be cancelled. If the payment is still pending after the end of the algorithm, the instruction of the participant will be taken immediately into account.

Algorithm 1 determines for each participant those payments which can be executed in compliance with the participant’s bilateral and multilateral limit position.

The algorithm calculates the potential changes in the balances that would occur if those payments were executed. Those changes are separately calculated for each relationship for which the participant has set a bilateral limit and for the total sum of relationships for which a multilateral limit is set.

These individual liquidity positions are aggregated to form a participant’s total liquidity position.

Consequences of a running algorithm

Algorithm 1: All-or-nothing optimisation

2 User Guide for Payments Module (PM)

- 2.7 Processing of payments
- 2.7.3 Dissolution of payment queue

Main characteristics and functioning

The following diagram and table explain the main characteristics and rough functioning of algorithm 1:

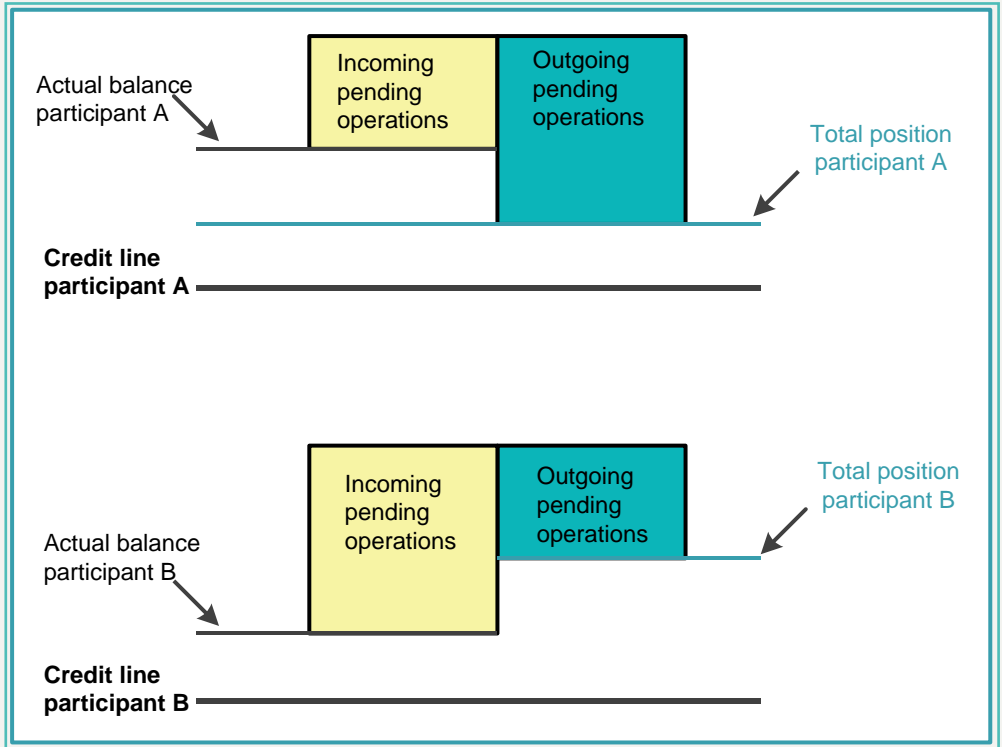

2 User Guide for Payments Module (PM)

- 2.7 Processing of payments
- 2.7.3 Dissolution of payment queue

Step	Description
1	For each direct PM participant, the total position is calculated. It consists of the sum of actual balance, + incoming payments, ./. outgoing payments.
2	If all total positions are covered and the settlement criteria are fulfilled (ie bilateral or multilateral limits and liquidity reservations are not breached; time indicator is fulfilled), all transactions will be settled.
3	If merely one position is not covered or if one settlement criteria is not fulfilled (ie bilateral or multilateral limit or liquidity reservation would be breached; time indicator is not fulfilled) no transaction will be settled and algorithm 2 is triggered.

Algorithm 2: Partial optimisation

In addition to algorithm 1 this algorithm removes individual payments in order to avoid insufficient cover. This earmarking of payments for removal (that is maintaining in the payment queue) is limited to participants for which an uncovered position was calculated as result out of the calculation of the total liquidity position.

2 User Guide for Payments Module (PM)

- 2.7 Processing of payments
- 2.7.3 Dissolution of payment queue

Main characteristics and functioning

The following diagram and table explain the functioning of algorithm 2:

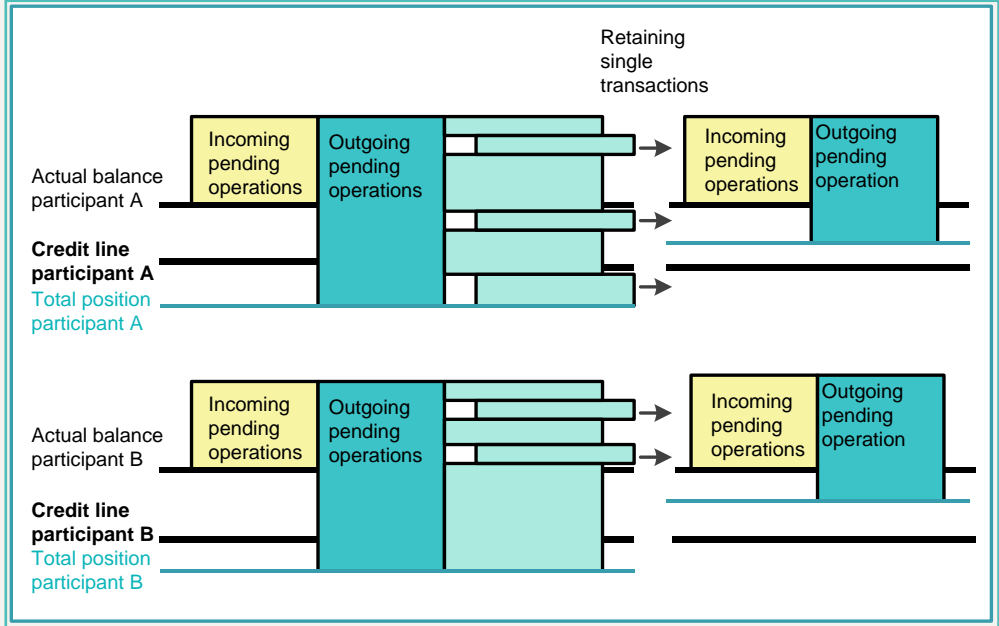

Step	Description
1	For each direct PM participant, the total position is calculated according to algorithm 1. All total positions are checked for cover.
2	If all total positions are covered, all transactions will be settled.
3	If merely one total position of a direct PM participant is not covered, single transactions will be retained till the liquidity of the participant is sufficient for covering its total position. Retained transactions are included in the next clearing process. The executable transactions are settled.

For the retaining of transactions the following rules apply:

- The selection process only runs for a short time.
- Transactions at the end of the queue with lowest priority are first checked concerning retaining.
- The selection is started with the direct PM participant with the highest uncovered total-debit position.

If run of algorithm 2 does not succeed, algorithm 3 will be activated.

The aim of algorithm 3 is resolving of the queues with the highest possible settlement volume and low liquidity demand.

This optimisation process consists of two parts following one after another. It starts with resolving of bilateral relationships and ends with resolving of the multilateral payments.

Algorithm 3: Multiple optimisation

2 User Guide for Payments Module (PM)

- 2.7 Processing of payments
- 2.7.3 Dissolution of payment queue

Part 1

The following diagram and table explain the functioning of part 1 of algorithm 3:

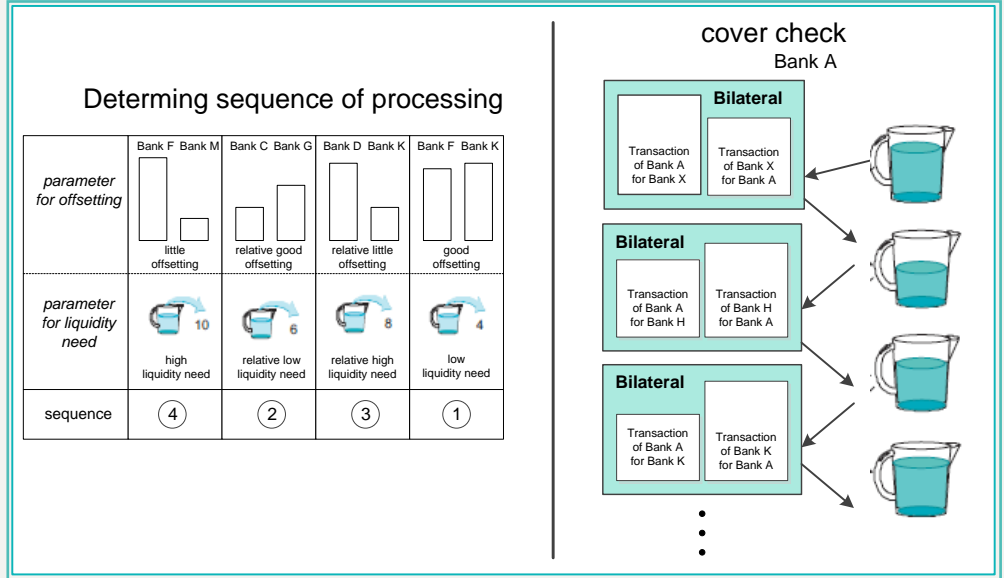

Transactions which should be processed bilaterally (ie between two participants of which at least one has defined a bilateral limit towards the other) are cleared as follows:

Step	Description
1	Determine the objective sequence of how the bilateral queue should be worked through: first the pairs of transactions with the best offsetting, then the other pairs of transactions.
2	Check the bilateral positions regarding coverage. If the settlement of a transaction is not possible due to a lack of liquidity or breached limits, single transactions will retain in the queue.
3	The identified covered transactions are immediately settled before the algorithm continues with the next pairs of transactions.

2 User Guide for Payments Module (PM)

- 2.7 Processing of payments
- 2.7.3 Dissolution of payment queue

Rule for retainment

If the settlement of a pair of queues is not possible due to lack of liquidity or breached limits, single payments will retain in the queues (under consideration of the FIFO-principle).

Part 2

The check of bilateral relations is followed by the check of multilateral relations (between one participant and others towards which a multilateral limit is defined): how the remaining transactions influence the balance of each participant. Uncovered transactions or transactions which breach defined limits are retained (in the same manner as in algorithm 2).

The following diagram and table explain the functioning of part 2 of algorithm 3:

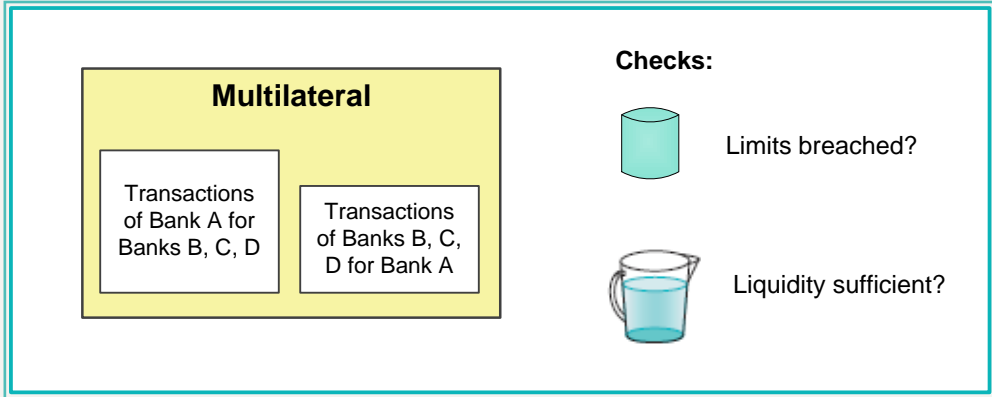

Transactions which should be processed multilaterally are cleared as follows (step 1 - 3 are repeated until each uncovered multilateral position is checked):

Step	Description
1	Check the multilateral position regarding coverage.
2	If the settlement of a transaction is not possible due to a lack of liquidity or breached limits, single transactions will retain in the queue.
3	The identified executable transactions are settled.

2.7	Processing of payments
2.7.3	Dissolution of payment queue

Algorithm 4: Partial optimisation with ancillary system

Algorithm 4 is developed to support the simultaneous multilateral settlement of AS (procedure 5 - see chapter [2.8 Settlement of ancillary systems, page 174](#)). It ensures an efficient and fast processing of the related AS transactions. To smooth the settlement and to reduce the liquidity needed, other “highly urgent” payments as well as “urgent” and “normal” ones are included.

General remarks

- AS payments to be settled following procedure 5 bypass the entry disposition and are kept in the PM separately till the end of the current optimisation process.
- Up to this time this separation is necessary. Otherwise they would block the settlement of other payments because of their priority.

Note: As long as no AS following procedure 5 is queued and payments are pending, the algorithms 1 - 3 run successively. See below for more details on the sequence of algorithms.

2 User Guide for Payments Module (PM)

- 2.7 Processing of payments
- 2.7.3 Dissolution of payment queue

Functioning in general

The following diagram and table explain the functioning of algorithm 4:

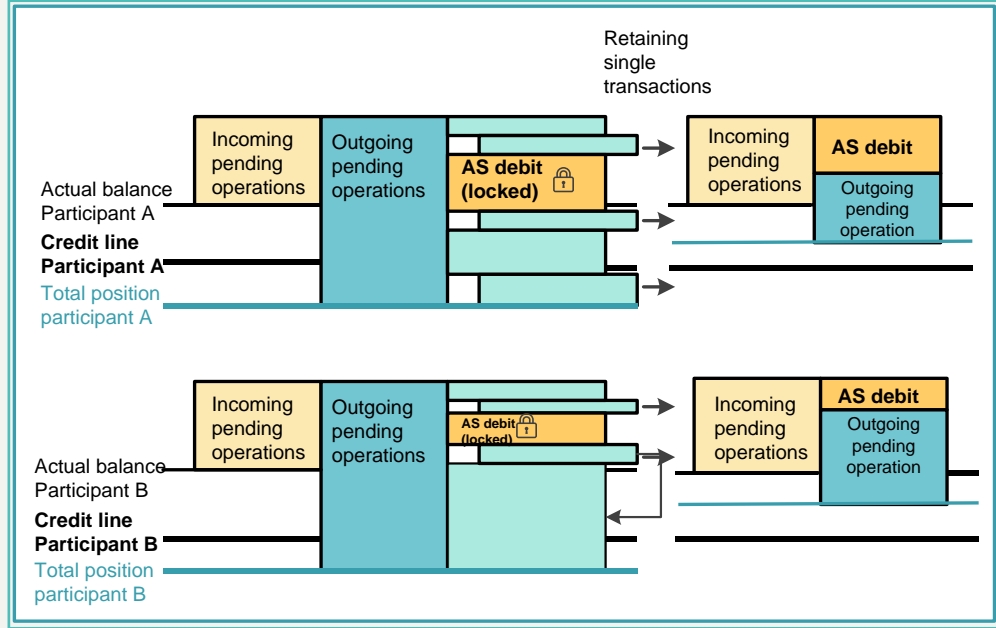

Step	Description
1	For each direct participant, the total position is calculated according to algorithm 1. All total positions are checked for cover.
2	If all total positions are covered, all transactions will be settled.
3	If just one total position of a participant is not covered, single transactions will be retained until the liquidity of the participant is sufficient for covering its total position. During the selection procedure the AS position remains unchanged (ie AS debits are never retained). Retained transactions are included in the next clearing process.

Details on the main principles

Inclusion of all pending payments:

Algorithm 4 takes all pending payments into account. The inclusion is independent:

- on whether sender and receiver are settlement banks of an AS using the simultaneous multilateral settlement or not
- from the type of payment (highly urgent, urgent, normal)

This broad approach is chosen to keep the whole settlement process running in the PM. It also helps to smooth the settlement process because of taking offsetting payments into account.

Ordering of AS payments in the queue

Payments to be settled by the use of algorithm 4 are ordered

- by their payment type (highly urgent, urgent, normal)
- within the payment type following
 - the time they have entered the SSP (FIFO principle)
 - their earliest debit time if defined (exception 1)
 - the time of the start of the settlement period (exception 2 - only for AS related payments)

Several AS involved in one running algorithm 4

In the same run of algorithm 4 several AS using procedure 5 (procedure 5 - see chapter [2.8 Settlement of ancillary systems, page 174](#)) will be included if they intend to settle at the same time.

- Algorithm 4 calculates the position of each direct PM participant including all pending payments. For debit positions it is checked whether sufficient liquidity is available.
- If at least one participant does not have sufficient liquidity, algorithm 4 will select the participant with the largest uncovered debit position; then it re-

Settlement process in detail

tains payments of this participant for optimisation till its position is covered. (Same retaining rules as algorithm 2).

- If the payment selected is an AS payment using simultaneous multilateral settlement also all other payments of the related AS will be retained from the optimisation process.
- As long as there are still payments stemming from other AS using procedure 5, algorithm 4 continues running (= a further loop within the same run will start). In this further loop also those payments are included that were retained before, with exception of retained AS payments following procedure 5.
- Algorithm 4 will end:
 - a) if there are no procedure 5 AS payments included in the settlement process any more.
 - b) or the time defined as maximum for a run of algorithm 4 has elapsed.
 - c) or all debit positions are covered.In case a) and b) all payments included in the optimisation return to their state previous to the running of algorithm 4. In case c) all payments that are not retained are settled.

Note: Due to the fact that also normal payments are included in the optimisation process it is also checked during the run of algorithm 4 that no limits are breached. Otherwise the payment breaching the limit has to be retained independent from the availability of liquidity.

Time sequence

At the entry time of an AS settlement following procedure 5, algorithm 4 will start. In case algorithm 1, 2 or 3 is running at the beginning of the settlement period algorithm 4 waits till the running algorithm ends and then starts immediately.

If algorithm 4 is successful (case 1 in the diagram below) the simultaneous multilateral settlement will be finished. The sequence of the other algorithms (1, 2 and 3) continues.

If algorithm 4 is not successful or only partly successful in the first run (case 2 in the diagram below) the next run of algorithm 4 will start after a prede-

2 User Guide for Payments Module (PM)

- 2.7 Processing of payments
- 2.7.3 Dissolution of payment queue

defined time period. In the meantime the algorithms 1, 2 or 3 can run and settle payments. The reason for this not to stop the whole system for a longer period of time.

The time period is a parameter defined in SSP to have a minimum interval between two runs. It is the same for algorithms 1, 2 and 3. There is also a minimum interval defined between the runs of these algorithms.

The following diagram illustrates the time sequence:

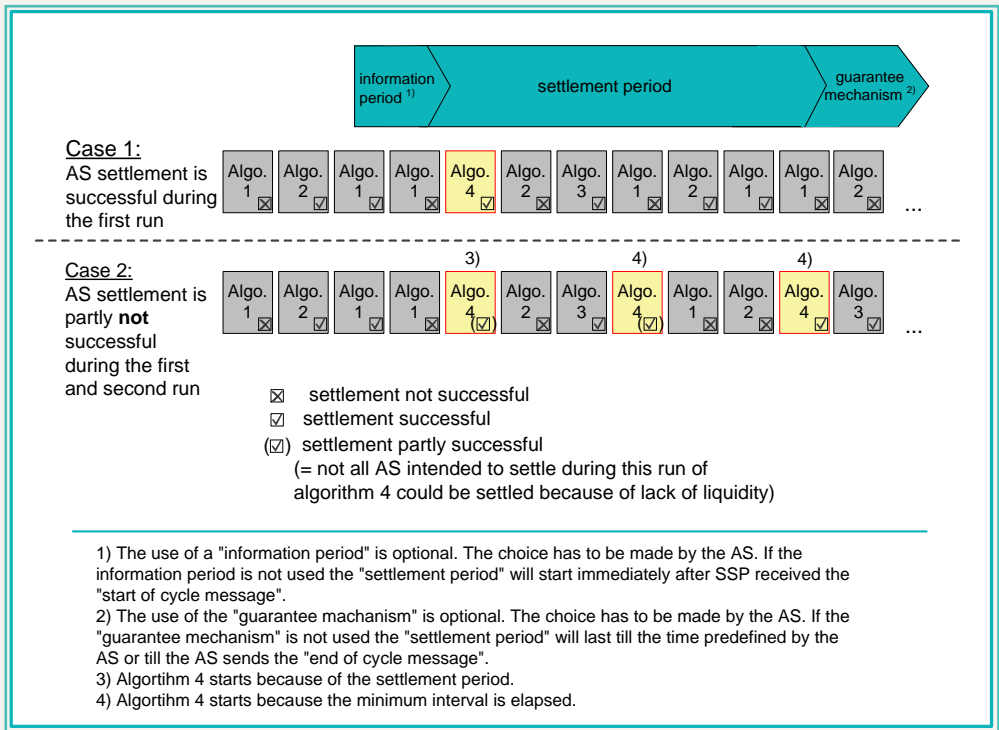

If algorithm 4 is running and during this time the entry time of another AS using procedure 5 is reached, the AS payments will remain waiting till the current algorithm 4 ends and the next one will start after the minimum interval.

Algorithm 5: Optimisation on sub-accounts

2.7.3.3 Optimisation on sub-accounts

The functioning of algorithm 5 is partially comparable to the optimisation of algorithm 1 but with some specialities/exceptions. It aims at resolving AS payments using dedicated liquidity on sub-accounts. The algorithm only checks sub-accounts instead of RTGS accounts. Only covered payments are settled. In case of uncovered payments, these payments are put back in the queue of the single sub-account. It runs only once a time until the next start by ASI. Furthermore, algorithm 5 doesn't have to consider any limits or reservations.

The following diagram and table explain the functioning of algorithm 5:

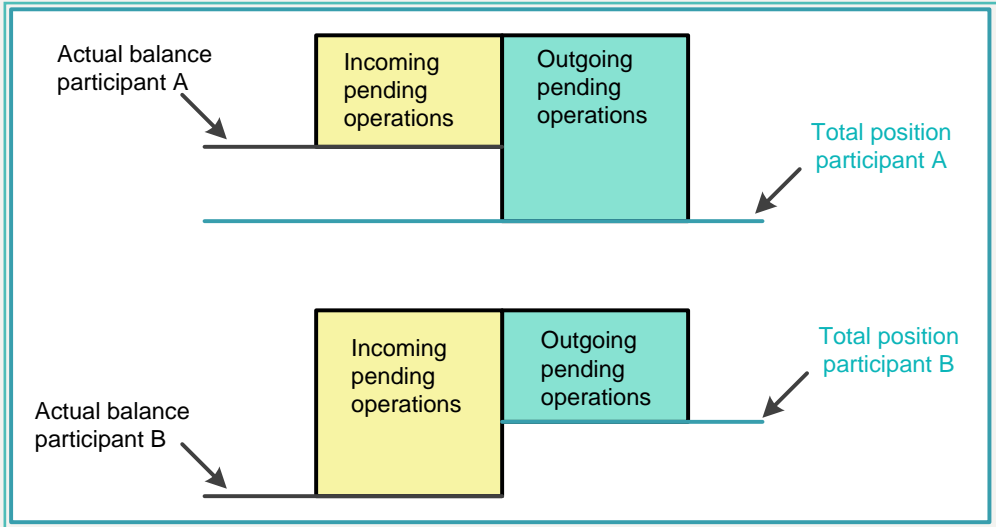

2.7 Processing of payments

2.7.4 Processing backup payments

Step	Description
1	For each direct PM participant (settlement bank), the total position is calculated. It consists of the sum of actual balance on one sub-account + incoming payments ./. outgoing payments for this sub-account.
2	If all total positions are covered, all transactions will be settled, provided they meet the other settlement criteria (ie time indicator is fulfilled).
3	Payments which are not covered are put back in the queue.
4	At the end of the cycle all transactions debiting the same sub-account with insufficient liquidity for their settlement are rejected even if only one transaction cannot be settled.

2.7.4 Processing backup payments

Note: In this section the term “backup” is used to describe a scenario where a TARGET 2 participant has suffered a major system outage so that it is unable to make payments in the ordinary course of business.

2.7.4.1 Generation

Protection against unauthorised generation of backup payments, both back-up contingency as well as backup liquidity redistribution payments is ensured because

- the generation of backup payments must first be enabled by the National Help Desk at the central bank responsible for the PM participant facing technical problems (ie affected participant),
- the number of people authorised to generate these payments, can be kept small (separate user group in the ICM),
- the “four eyes“ principle (different people responsible for initial recording and release) is obligatory,

Security

2 User Guide for Payments Module (PM)

2.7 Processing of payments

2.7.4 Processing backup payments

Generation of backup payments

- as far as possible, backup payments are generated automatically in the PM.

Both, backup contingency and backup liquidity redistribution payments are generated according to the following procedure:

Stage	What needs to be done
1	Information the National Help Desk at the central bank responsible for the affected SWIFT-based PM participant. Result: The National Help Desk activates the backup functionality in the ICM for the SWIFT-based PM participant concerned.
2	ICM users from the affected participant have to re-login to ICM before being able to open the backup functionality. Generation of backup contingency and backup liquidity redistribution payments in the ICM by users from the affected SWIFT-based PM participant or by the NCB acting on behalf of affected SWIFT-based PM participant. For information on data input see section 2.4.5.

2.7.4.2 Notification to the affected participant (sender)

On request, the affected participant as sender of a backup contingency or backup liquidity redistribution payment receives a debit notification via SWIFTNet FIN (MT 900). The debit notification reaches him as soon as the affected participant's SWIFTNet FIN connection is operational again.

Field 72 of the MT 900 contains the tag /BUP/ to indicate that the payment was initiated using the backup functionality in ICM.

2.7.4.3 Notification to the receiver

The receiver gets the payment as usual via SWIFTNet FIN.

Field 72 of the MT 202 contains the tag /BUP/ to indicate that the payment was initiated as backup payment via ICM.

The indication in the statement message is done by the tag “BUP“as well.

2.7.4.4 Treatment in the settlement process

Principles

- Backup contingency and backup liquidity redistribution payments are transferred to the PM in the order in which they were generated.
- They go through the same clearing and settlement process (entry management, queue dissolution) in the PM as regularly submitted
 - highly urgent payments (in case of backup contingency payments in favour of CLS)
 - urgent payments (in case of backup contingency and backup liquidity redistribution payments)
- They are visible in the display of pending payments in the ICM with the payment type “Backup Payment“
- If they are in the queue for highly urgent (in case of CLS backup contingency payments) or urgent (in case of other backup contingency and backup liquidity redistribution payments) payments, they will be treated in the ICM like any other payments. They can therefore be:
 - revoked
 - reordered in the payment queue

2.7.5 Subsequent delivery of single payments

Basic principles

Backup contingency payments as well as liquidity redistribution payments using the backup functionality are considered as payments on their own. This means that when resuming normal operations there is no need to resend the same or a similar payment via the standard channel to confirm the backup payment.

If following the recovery of the failed participant the original payments, which may have already been queued within the participant's environment, are still released by the affected participant by mistake, there is no control at the SSP which prevents these payments to be processed. It is in the responsi-

bility of the affected participant as sender to follow up on these payments with the receiver of the funds.

If the affected participant resumes normal processing on the same day before the closing of the day-trade phase, those payments still to be processed on the participant's side can be released as normal towards TARGET2.

If the affected participant resumes normal operations only on the following day or later, it may choose between two options for those pending payments still to be processed depending on the set-up of its processing engine:

- Transmission of the pending payments with the current (new) value date in field 32A (see chapter [2.7.5.1 Transmission of unprocessed payments with new value date, page 173](#)) or
- Transmission of the pending payments with the past (original) value date in field 32A (see chapter [2.7.5.2 Transmission of unprocessed payments with original value date, page 173](#)).

Independent from the date contained in field 32A, on the TARGET2 accounts all payments are booked with the business day applicable at the time when these payments arrive (exception: warehoused payments with future date in field 32A) and are settled, as TARGET2 provides only for same day settlement.

2.7.5.1 Transmission of unprocessed payments with new value date

These payments are released by the affected participant after resuming normal operations like any other new payments; there is no special treatment of these payments necessary.

2.7.5.2 Transmission of unprocessed payments with original value date

Choosing this option the affected participant has to take into account the following process for executing the payments with original value date:

2.8 Settlement of ancillary systems

2.8.1 Ancillary System Interface

- The affected participant must request the temporary lifting of the value date check to the National Service Desk, which will switch off the value date for the current business day.
- If more than the current business day is required for dealing with the unprocessed payments with old value date, than the lifting of the value date check for any consecutive business day has to be requested separately at the beginning of the concerned day trade phases.
- Once having completed the sending of payments with original (past) value date, the affected participant should inform the National Service Desk in order to reactivate the value date check with immediate effect.

Not all recipients may be in the position to process payments with a value date in the past (eg also some technical TARGET2 BICs). Further information in this respect can be found in the Information Guide for TARGET2 users.

The bookings in the PM are sorted by payment value date in field 32 of the payment message. A separate statement (MT 940/950) is issued for each value date used in the messages delivered by the affected participant, but all payments are, as mentioned above, booked with the current business date on the TARGET2 accounts.

2.8 Settlement of ancillary systems

2.8.1 Ancillary System Interface

Account statements sorted by value date

Overview

From market and oversight perspective, there are strong requirements to settle the cash leg of securities transactions and other comparable transactions (from retail or large-value payment systems, money market systems, clearing houses, etc.) in central bank money. In the interest of credit institutions and ASs, the needed functionality is also offered by the SSP.

Standardisation

The ASI is a standardised interface for:

- Messages (SWIFTNet standard messages)

2 User Guide for Payments Module (PM)

2.8 Settlement of ancillary systems

2.8.1 Ancillary System Interface

- Network and services (SWIFTNet services)
- Settlement processing (generic settlement procedures - see below)

Nevertheless, by using optional mechanisms (see below), it is possible to fine-tune the ASI to the already existing AS procedures.

Advantages for ASs are:

- Broader accessibility of participants (also in a cross-border context)
- Broad range of streamlined functionality

Advantages for credit institutions as participants of the ancillary systems using the ASI:

- Possibility to use only one RTGS account for several ancillary systems
- Cross-border usage - an RTGS account held with one CB can be used for settling transactions stemming from ancillary systems from other countries
- Integration with normal payment business
- Highest priority for AS transactions

Users

The ASI can be used by CBs, for their own purposes (eg cash withdrawals) or on behalf of ASs, and by ASs themselves.

By using the ASI, an ancillary system can control the initiation of liquidity flows. The responsibility of the provision of the needed liquidity on the settlement bank's RTGS account is up to each AS participant.

AS types

Ancillary systems are:

- Retail payment systems
- Large value payment systems
- Foreign exchange systems
- Money market systems

Advantages for ancillary systems and credit institutions

- Clearing houses (CCP)
- Securities settlement systems (SSS)

Information flows

ASs and settlement banks can rely on a comprehensive information flow for a full visibility on the status of payments/net balances issued at any time, swiftly, during the entire process. The information is available in a pull mode in the ICM.

In addition to the information on individual payments/net balances the ICM provides ASs, CBs and settlement banks with aggregated data. These aggregated data will be:

- Number and amount of transactions related to AS settlement
- Transactions queued because of lack of liquidity
- Uncovered transactions shortly before a settlement period ends
- Rejected, revoked or reversed transactions
- Booked transactions
- Balances of AS technical accounts, technical account - procedure 6 real-time, and guarantee funds accounts
- Liquidity needed on the technical guarantee funds account
- Available liquidity on sub-accounts
- Manual and automatically increased liquidity in the settlement cycle; automatically transferred liquidity back from dedicated account to the main account, values of all standing orders (settlement procedure 6, see below)

Reordering

CBs on behalf of their settlement banks (=debtor) are permitted to reorder AS payments (except payments of settlement procedures 5 and 6) within the payment queue.

If the settlement bank (=debtor) is a member of a virtual group of accounts, reordering is only permitted to the responsible CB of the group of accounts manager.

Ancillary systems transaction types

By means of the ASI, ancillary systems may initiate, in XML format, different transactions types:

1. debits of its own account against credits of the settlement bank's accounts (transactions similar to credit transfer payments)
2. debits of the settlement bank's accounts against credits of its own account (transactions similar to direct debit payments)
3. debits of the settlement bank's accounts against credits of other settlement banks (transactions similar to mandated payments)

All transactions settled through ASI benefit from the highly urgent priority.

As ancillary system settlement payments are highly urgent payments, the FIFO-principle is valid also for these transactions.

The AS messages can only be sent for a settlement during the current business day. Warehoused payments are not allowed.

2 User Guide for Payments Module (PM)

2.8 Settlement of ancillary systems

2.8.1 Ancillary System Interface

Settlement procedure

Six generic settlement procedures are provided by the PM via the ASI.

No.	PM generic settlement procedure	Interaction (batch/ realtime)	Transaction type	Description	Suitable for...
1	Liquidity transfer	Real-time link	1	Liquidity transfer from/to technical account - procedure 6 real-time to/from a settlement bank's RTGS account.	<p>Liquidity transfer for real-time model between settlement bank's RTGS account and cash positions within the AS. Single provisioning of liquidity on initiative of the debtor.</p> <p>Note: Although still present in TARGET2, procedure 1 should not be used anymore since it is limited to daylight processing only. For details please refer to the Guideline on TARGET2 and its amendments (https://www.ecb.europa.eu/ecb/legal/1003/1349/html/index.en.html).</p>
2	Real-time settlement	Real-time link	1, 2 and 3	ASs perform a real-time settlement either in the accounts of two PM participants or between a PM participant and the AS technical account.	<p>Settlement of transaction coming from a single transaction oriented DVP model.</p> <p>Settlement of independent balances (eg margin</p>

2 User Guide for Payments Module (PM)

2.8 Settlement of ancillary systems

2.8.1 Ancillary System Interface

No.	PM generic settlement procedure	Interaction (batch/ realtime)	Transaction type	Description	Suitable for...
					calls). Settlement of multilateral balances: in this case the dependencies among balances have to be managed at the AS level.
3	Bilateral-settlement	Batch	1, 2 and 3	AS sends simultaneously debits and credits to PM. Each transaction (both the debit and the credit leg) is processed independently from the other one.	Settlement of independent individual transactions coming from batch oriented DVP model. Settlement of independent balances (eg margin calls). Settlement of multilateral balances: in this case the dependencies among balances have to be managed at the AS level. Note: It is also possible to use a technical account-procedure 6 real-time for procedure 3. In such case procedure 6 real-time can be used in addition.

2 User Guide for Payments Module (PM)

2.8 Settlement of ancillary systems

2.8.1 Ancillary System Interface

No.	PM generic settlement procedure	Interaction (batch/ realtime)	Transaction type	Description	Suitable for...
4	Standard multilateral settlement	Batch	1 and 2	AS sends simultaneously debits and credits. All debits have to be booked before credits are settled.	Settlement of dependent balances (sum of debits equal sum of credits). First debit balances are booked on settlement banks' RTGS accounts and therefore liquidity is blocked until last debit position is covered. Afterwards all credit balances will be immediately booked.
5	Simultaneous multilateral settlement	Batch	1 and 2	AS sends simultaneously debits and credits to PM. All debits and credits are simultaneously checked for settlement. If this check is passed all debits and credits are booked simultaneously.	Settlement of dependent balances (sum of debits equal sum of credits) in "one-shot-mode" debit and credit balances will bypass entry-disposition and be placed in the waiting queue together with other remaining payments. Automatically a special algorithm is started, trying to book debit and credit balances together in one shot. If the attempt is not successful, all balances of the relevant AS will be neutralised (not visible for

2.8 Settlement of ancillary systems

2.8.1 Ancillary System Interface

No.	PM generic settlement procedure	Interaction (batch/realtime)	Transaction type	Description	Suitable for...
					ongoing settlement) till the next attempt is foreseen (triggered by a time parameter). Until the next attempt starts, a change of the account balance (increase or decrease) is possible due to incoming or outgoing payments.
6	Settlement on dedicated liquidity accounts	Batch	1 and 2	Settlement bank can dedicate a liquidity amount to settle balances coming from a specific AS. The dedication is achieved by setting aside the needed liquidity on a specific sub-account (interfaced model) or on the technical account - procedure 6 real-time managed by the AS (real-time model). Such a settlement procedure can be used both for night-time (the dedicated liquidity is set aside with next value date) and day-light business.	Interfaced and real-time model Note: Model 6 real-time and Model 6 interfaced should not be both selected for a single AS. There would be possible conflicts in the management of procedures and cycles.

2 User Guide for Payments Module (PM)

2.8 Settlement of ancillary systems

2.8.1 Ancillary System Interface

Optional connected mechanisms

Note: Batch means simultaneous sending of all the debit and credit transactions not necessarily involving the simultaneous settlement.

In addition to a settlement procedure the following pre- and post-connected mechanisms can be used to regulate the ASI to specific needs:

Mechanism	Description
Information period	Settlement banks have to check their balances in the AS to collect the needed liquidity. In exceptional circumstances the settlement banks may express disagreement within the "information period" to avoid the settlement of erroneous balances (the suitable communication means has to be agreed within the contractual relationship with the AS).
Scheduled time ("from")	If an AS sends instructions before the scheduled settlement time, payment instructions are stored until scheduled settlement time is reached.
Settlement period ("till")	A limited period of time is allocated to the settlement by the AS, so as not to prevent or postpone the settlement of other operations. The transactions not settled at the end of this period, are rejected or a guarantee fund mechanism can be activated (see below).
Guarantee fund mechanism	In case an AS cannot settle using the settlement bank's liquidity only, this mechanism provides the complementary liquidity needed according to pre-defined rules.

The optional mechanisms available for each settlement procedure are shown in the table below:

No.	PM generic settlement procedure	Information period	Scheduled time ("from")	Settlement period ("till")	Guarantee fund mechanism
1	Liquidity transfer		X	X	
2	Real-time settlement		X	X	
3	Bilateral settlement	X		X	
4	Standard multilateral settlement	X		X	X
5	Simultaneous multilateral settlement	X		X	X
6	Settlement on dedicated liquidity accounts				

Collateralisation

As far as SSSs are concerned, it has to be noticed that these specific ASs are both SSP users (to settle in central bank money the cash leg of securities transactions on a DVP basis) and service providers for the Eurosystem (Eurosystem counterparts can access via SSSs to the collateralised Eurosystem's liquidity).

The mentioned double role (user and service provider) is often combined during the settlement cycles through the so-called auto-collateralisation in the form of:

- "firm" collateralisation (collateralisation on stock: participants single out the eligible securities that could be used)
- "self" collateralisation (collateralisation on flows: with securities deriving from the settlement process itself)

Due to the relevance of the possibility of increase the liquidity available for the settlement via the two mentioned collateralisation techniques, the ASI will provide specific functionality to allow an automatic increase of the liquidity dedicated to the settlement of specific AS's transactions (notably balance coming from procedure 6) both for the daylight and the night-time business.

Moreover, the AS can increase the liquidity set-aside by its participant by specific credit transfers via ASI (ie liquidity drawn from coupon and redemption payments).

Participation

According to the TARGET Guideline (Article 3, (a) 1.) which defines the participation criteria for TARGET, "supervised credit institutions (as defined in Article 4 (1) of Regulation (EU) No 575/2013) which are established in the EEA shall be admitted as participants". The TARGET Guideline also specifies the Ancillary System participation as follow:

Ancillary system (AS) is a system managed by an entity established in the EEA that is subject to supervision and/or oversight by a competent authority and complies with the oversight requirements for the location of infrastructures offering services in euro, as amended from time to time and published on the ECB website, in which payments and/or financial instruments are exchanged and/or cleared while the resulting monetary obligations are settled in TARGET2 in accordance with this guideline and a bilateral arrangement between the ancillary system and the relevant eurosystem CB".

Therefore, AS which are also supervised credit institutions are entitled to be SSP participant. Other AS (provided they are subject to oversight by a competent authority) may be admitted as SSP participant depending upon national rules.

AS participants can settle their transactions on the SSP directly (direct participation) or through designated PM participants (the settlement banks - indirect participation).

ASs access to the SSP

Three interfaces are provided to users:

- The participant interface (PI) provided to direct participants for the payment processing. It is based on SWIFT FIN copy.
- The Ancillary System Interface (ASI) provided to ancillary systems for the settlement of their operations. It is based on SWIFTNet services (InterAct and FileAct), SWIFT FIN copy based on usage on dedicated ASI technical BIC and on XML messages.
- The ICM provided to direct participants and ancillary systems for information and control. It is based on SWIFTNet services (InterAct and FileAct) and on XML messages.

As far as ASs are concerned the access to the settlement within the SSP will be possible both via the participant interface (PI) and the Ancillary System Interface (ASI).

It is worthy to highlight that only when AS operations are submitted through the ASI advanced services are available:

- Centralised control of the authorisation to debit one account
- Links between payments (in case of multilateral settlement for example)
- Optional mechanisms such as information period, settlement period, guarantee mechanism
- Reservation and blocking of liquidity before settlement (in case of procedure 6 interfaced)
- Use of highly urgent priority
- Use of mandated payments
- Use of special accounts: technical account, technical account – procedure 6 real-time, guarantee account (see below)

If an AS does not use the ASI, it will not have access to the services presented above and will have to set up mechanisms of settlement based on

2 User Guide for Payments Module (PM)

2.8 Settlement of ancillary systems

2.8.1 Ancillary System Interface

AS not using ASI

the services provided to direct participants for RTGS accounts through the use of the PI.

In particular:

- It will not have access to mandated payments and will have to be empowered by a specific contractual agreement for the use of direct debits.
- It will not have the possibility of using special accounts.
- It will not benefit of the six proposed settlement procedures.
- It will not be able to initiate payment with highly urgent priority.

AS using ASI

The AS using the ASI is required to send the list of pertaining settlement banks to its CB and, on each business day, possible updates of this list (this workflow is outside of the SSP processing). Then, it is up to the CB of the AS to enter the list of settlement banks in the static data and to maintain it up to date. New settlement banks have to be approved, according to national rules, by the relevant CB before becoming operating.

To secure ASs settlement procedures, the updated list of settlement banks of each AS can be downloaded via ICM by this AS.

The AS is responsible of sending transactions only to its approved settlement banks; the SSP checks in any case before the payment processing the relation between the settlement bank and the related AS.

The normal ASI operations via SWIFT FIN copy via dedicated ASI technical BIC, are limited to the liquidity transfer from settlement bank to technical account – procedure 6 real-time or sub-account.

For contingency reasons it is possible to send and receive payments to/from technical account – procedure 6 real-time via Participant Interface (PI). It is forbidden for AS technical account.

Accounting

The following accounts will be offered in TARGET2 for the specific use of AS:

- **TECHNICAL ACCOUNT - PROCEDURE 6 REAL-TIME:**

With the real-time model the funds held on the technical account procedure 6 real-time are mirrored in the books of ACHs. With ASI procedure 6 real-time, it is possible to assign the technical account - procedure 6 real-time either to a CB or an AS. Only in case an AS technical account - procedure 6 real-time is used as auto-collateral account, this account must not be "credit based only". All other technical accounts - procedure 6 real-time (i. e. not used as auto-collateral account) may or may not be "credit based only". These accounts are in fact specific technical accounts opened to CBs. In addition, technical accounts - procedure 6 real-time are used by AS having opted for procedure 6 (real-time model) and can also be used in the framework of procedure 3.

- **TECHNICAL ACCOUNT:**

whose balance can be 0 at least at the end of the AS's settlement process (procedures 2, 3, 4, 5, 6) or at the most positive. Their holder is the AS. The end of day balance of this account has to be 0. One specific and dedicated technical account has to be opened for the settlement using procedure 4 and one for procedure 5.

- **GUARANTEE FUNDS ACCOUNT:**

used in case the optional guarantee mechanism has to be activated by an AS or a CB on its behalf. The same guarantee account can be used for procedures 4 and 5; it is also possible to use two different ones.

- **SUB-ACCOUNTS:**

to set-aside liquidity for exclusive settlement of a specific AS using procedure 6 (interfaced model).

Following its explicit requirements every AS can open more than one account in order to link each one to a specific function (settlement of the balances on technical accounts, guarantee on guarantee funds account etc.). In particular it is recommended to implement a segregation between settle-

2 User Guide for Payments Module (PM)

2.8 Settlement of ancillary systems

2.8.1 Ancillary System Interface

ment business and transactions related to AS different from settlement processing.

The table below summarises the modalities of operation of these accounts:

Typology	Technical account - procedure 6 real-time	Technical account	Guarantee funds account	Sub-account
Procedure	1, 3, 6	2, 3, 4, 5, 6	4, 5	6
Use	<ul style="list-style-type: none"> liquidity transfers between RTGS accounts and AS technical account – procedure 6 real-time increase of the dedicated liquidity triggered by auto-collateralisation settled through mandated payments (procedure 6 option C) 	<ul style="list-style-type: none"> liquidity transfers processed through direct debit/credit transfer (procedure 2) direct debit and credit transfer settlement (procedure 3) debits and credits posted during the settlement process (procedures 4 and 5) cash balances processed through direct debit/credit transfer (procedure 6 interfaced model) settlement of specific transactions 	<ul style="list-style-type: none"> debits and credits posted during the settlement process (procedures 4 and 5) 	<ul style="list-style-type: none"> liquidity transfer from/to the RTGS account to set aside liquidity and the consequent settlement of procedure 6

2 User Guide for Payments Module (PM)

2.8 Settlement of ancillary systems

2.8.1 Ancillary System Interface

Typology	Technical account - procedure 6 real-time	Technical account	Guarantee funds account	Sub-account
		(all procedures) <ul style="list-style-type: none"> increase of the dedicated liquidity triggered by specific transactions (procedure 6) 		
Balance	Generally different from 0 during the business day (possibly negative).	Equal to 0 when the settlement process is closed. Different from 0 during the business day.	Positive or equal to zero.	Equal to 0 when the whole AS's settlement process is closed. At most positive during the settlement process.
Holder	CB or AS	AS	CB, AS, Guarantor	settlement bank

It is not necessary for an AS to open as many accounts as settlement procedures are used. Nevertheless, if settlement procedure 4 or 5 is used a specific technical account has to be opened for each of these procedures. So far the exact number of special accounts (Technical accounts – procedure 6 real-time, technical accounts and guarantee accounts) will have to be defined on a case-by-case basis in co-operation with the related CB.

All these accounts will be identified by a specific identifier:

Type	Identification	BIC directory	TARGET2 directory	CUG
Sub-account	BIC of RTGS main account + account number	NO	NO	NO

2.8 Settlement of ancillary systems

2.8.2 Work flow of settlement procedures (liq. trans., real-time, bilat., stand. and simult. multilat.)

Type	Identification	BIC directory	TARGET2 directory	CUG
Technical account	BIC	NO	NO	NO
Technical account - procedure 6 real-time	BIC	YES	NO	YES
Guarantee account	BIC	YES	NO	YES

For all these accounts the pertaining statements of holdings (MT 940, MT 950) can be provided to the holder by the end of the business day.

Note: The account number is composed of country code and up to 32 characters (according to the current national account structure).

2.8.2 Work flow of settlement procedures (liq. trans., real-time, bilat., stand. and simult. multilat.)

2.8.2.1 Liquidity transfer

General aspects

Although still technically present in TARGET2, procedure 1 shall not be provided to AS anymore. For details please refer to the Guideline on TARGET2 and its amendments

(<https://www.ecb.europa.eu/ecb/legal/1003/1349/html/index.en.html>). With procedure 1 an AS can perform a liquidity transfer from a technical account - procedure 6 real-time to a settlement bank's RTGS account:

- using the standard payment procedure (from RTGS to technical account - procedure 6 real-time, during daytrade phase)
- through the ASI

The latter procedure - described in this paragraph - is functional for AS using real-time model.

2 User Guide for Payments Module (PM)

2.8 Settlement of ancillary systems

2.8.2 Work flow of settlement procedures (liq. trans., real-time, bilat., stand. and simult. multilat.)

The liquidity transfer can be initiated either from the AS or a CB on its behalf (case A) or from the settlement bank (case B). The functionality of liquidity transfers from a settlement bank to the technical account - procedure 6 real-time for night-time processing is provided with settlement procedure 6 (see chapter [2.8.3.2.1 Night-time business: real-time model, page 223](#)).

The liquidity transfer settlement may include optional connected mechanisms:

- Scheduled time (“from“)
- Settlement period (“till“)

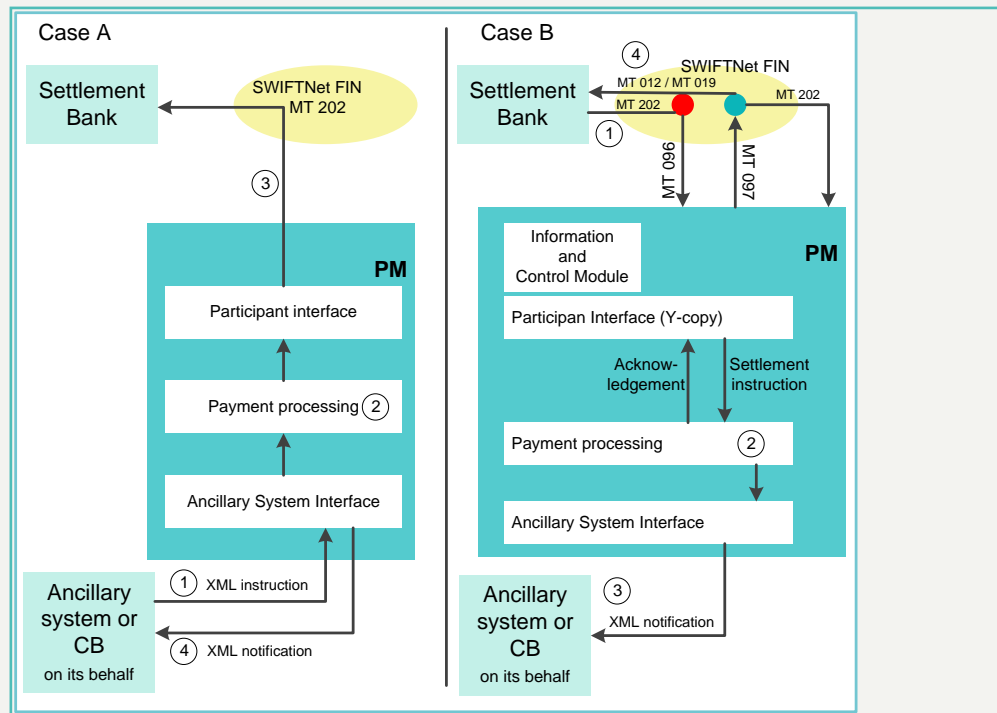

2 User Guide for Payments Module (PM)

2.8 Settlement of ancillary systems

2.8.2 Work flow of settlement procedures (liq. trans., real-time, bilat., stand. and simult. multilat.)

Case A

Liquidity transfer from the technical account – procedure 6 real-time to the settlement bank's RTGS account through ASI:

Phase	Step	Description
Initiation	1	The AS (or the relevant CB on its behalf) sends an XML message (ASTransferInitiation, see chapter 9.2.6 Use cases for AS, page 572) in order to debit the technical account - procedure 6 real-time (see chapter 9.1 SWIFTNet FIN related issues, page 409).
Settlement	2	The settlement process takes place: <ul style="list-style-type: none">• debiting the technical account - procedure 6 real-time• crediting the pertinent settlement bank's RTGS account The CB of the AS is allowed to revoke XML transactions that belong to the CB's AS as long as the payments are not final. A broadcast is sent to the AS and to the relevant settlement bank informing the revoked payment.
Notification	3	The settlement bank is notified on the credit via an MT 202 sent out by the PM. No notification possible for Internet-based settlement bank.
	4	The AS (or the relevant CB on its behalf) receives the positive or negative notification (ASInitiationStatus) on the settlement. In case of revocation of the payment, the AS receives the ASInitiationStatus with code status "revoked".

Case B

Liquidity transfer from the settlement bank's RTGS account to its cash account or the sub-participant account in the AS:

Phase	Step	Description
Initiation	1	The settlement bank or its home CB (Mandated payment) sends an MT 202 (Note: priority "highly urgent" is mandatory) to the specific PM BIC address TRGTXEPMASI (see chapter 9.1.1.1 Business Identifier Codes (BICs) for SSP, page 409). It is neither possible for an Internet-based participant by the dedicated ICM screen for Internet-based participant nor by LT to technical account - procedure 6 real-time via ICM screen, used for procedure 6.
Settlement	2	<p>The settlement process takes place:</p> <ul style="list-style-type: none"> • debiting the pertinent settlement bank's RTGS account • crediting the technical account - procedure 6 real-time <p>At this stage the ASI checks if the debited settlement bank is in the settlement banks list of the AS operating the technical account - procedure 6 real-time. If not the settlement fails. In case the debited settlement bank is in the settlement banks list of the AS operating the technical account - procedure 6 real-time the processing continues as follows:</p> <ul style="list-style-type: none"> • In case the transfer is initiated using a FIN message a "Scheduled Time (from)" can be indicated. • If the settlement bank has specified a "Scheduled Time (from)" the PM delivers the payment order to the entry disposition only when the "from" time is reached. • If a "Settlement period (till)" has been set (codeword "REJTIME" - see chapter 2.4.3 Definition of execution time, page 55), the PM, if the related payment is still pending, continuously checks whether the time limit is reached. If the time limit is exceeded the instruction is rejected. <p>The CB of the AS is allowed to revoke FIN message that belong to the CB's AS as long as the payments are not final. A broadcast is sent to the AS and to the relevant settlement bank informing the revoked payment.</p>

2.8 Settlement of ancillary systems

2.8.2 Work flow of settlement procedures (liq. trans., real-time, bilat., stand. and simult. multilat.)

Phase	Step	Description
	3	The AS (or the relevant CB on its behalf) receives an XML notification (ASTransferNotice see chapter 9.2.6 Use cases for AS, page 572) about the incoming liquidity including the information of the resulting balance (the forwarded leg of the Ycopy is not used).
	4	The settlement bank (or the home CB acting on its behalf) receives, on an optional basis, the appropriate settlement notification (MT 012). In case of settlement failure the settlement bank receives the appropriate notification (MT 019). If the settlement bank is an Internet-based participant, these notifications are not possible.

2.8.2.2 Real-time settlement

General aspects

This settlement procedure should be used by AS using an interfaced model where the final settlement takes place within the SSP.

The real-time settlement may include optional connected mechanisms:

- Scheduled time (“from“)
- Settlement period (“till“)

2 User Guide for Payments Module (PM)

2.8 Settlement of ancillary systems

2.8.2 Work flow of settlement procedures (liq. trans., real-time, bilat., stand. and simult. multilat.)

“Real-time settlement“ procedure could be used to settle multilateral balances of an AS that has a PM technical account. In such a case the AS should send to the SSP first individual debit transactions (to be credited on the AS technical account) and then (after all debits are settled) individual credit transactions (to be debited on the AS technical account).

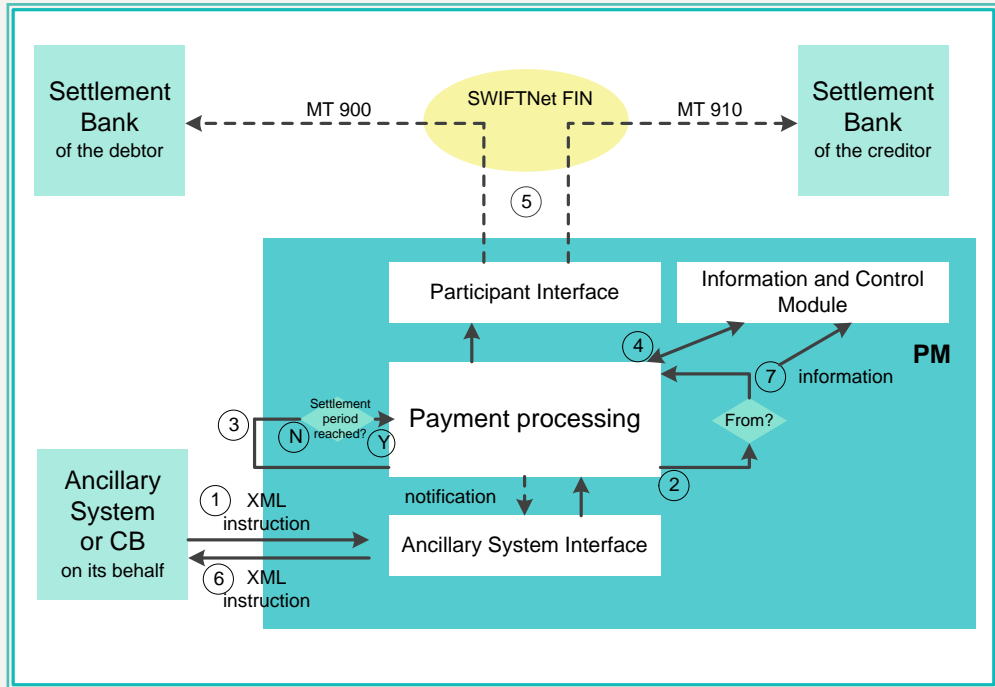

2 User Guide for Payments Module (PM)

2.8 Settlement of ancillary systems

2.8.2 Work flow of settlement procedures (liq. trans., real-time, bilat., stand. and simult. multilat.)

Phase	Step	Description
Initiation	1	The AS (or the relevant CB on its behalf) sends an XML message (ASTransferInitiation, see chapter 9.2.6 Use cases for AS, page 572) to debit the “debtor’s” settlement bank’s account and to credit the “creditor’s” settlement bank’s account. The account to be debited and the account to be credited can be the same. It is also possible to use this procedure to initiate transactions against the AS technical account (both on the debit and on the credit side).
Optional mechanisms	2	If the AS (or the relevant CB on its behalf) has specified a “Scheduled Time (from)” the PM delivers the AS transactions to the entry disposition only when the “from” time is reached.
Settlement	3	If the AS (or the relevant CB on its behalf) has indicated a “Settlement period”, the PM continuously checks whether the time limit is reached and the AS related AS transaction is still pending. If the time limit is exceeded, the settlement fails and the AS transaction not yet settled is rejected. The CB of the AS is allowed to revoke XML transactions that belong to the CB’s AS as long as the payments are not final. A broadcast is sent to the AS and to the relevant settlement bank informing the revoked payment.
	4	The settlement occurs with the debit/credit of the pertinent settlement bank’s RTGS accounts in PM (either RTGS settlement bank’s accounts or AS technical account). If liquidity is not sufficient, the AS transaction is posted in the waiting queue and the settlement bank is informed by a broadcast message delivered via the ICM.
Notification	5	On an optional basis, the settlement banks of the AS participants are notified in case of successful settlement via the respective MT (MT 900/910). Not possible for Internet-based settlement bank.
	6	The AS (or the relevant CB on its behalf) receives a confirmation XML message (ASInitiationStatus) in case both of successful settlement and of failure (ie for exceeded time limit). In case of revocation of the payment, the AS receives the ASInitia-

2.8 Settlement of ancillary systems

2.8.2 Work flow of settlement procedures (liq. trans., real-time, bilat., stand. and simult. multilat.)

Phase	Step	Description
		tionStatus with code status "revoked".
	7	At each stage, information is available for settlement banks and ASs through the ICM. In case of settlement failure no notification is sent to the settlement bank.

2.8.2.3 Bilateral settlement

Interaction mode is concerned. The payments are in fact sent in a batch (instead of real-time) mode.

The bilateral settlement may include optional connected mechanisms:

- Information period
- Settlement period ("till")

This procedure could also be used to settle multilateral balances of an AS that has an SSP technical account. In such a case the AS should first send to the SSP individual debit transactions (to be credited on the AS technical account) and then (after all debits are settled) individual credit transactions (to be debited on the AS technical account).

General aspects

2 User Guide for Payments Module (PM)

2.8 Settlement of ancillary systems

2.8.2 Work flow of settlement procedures (liq. trans., real-time, bilat., stand. and simult. multilat.)

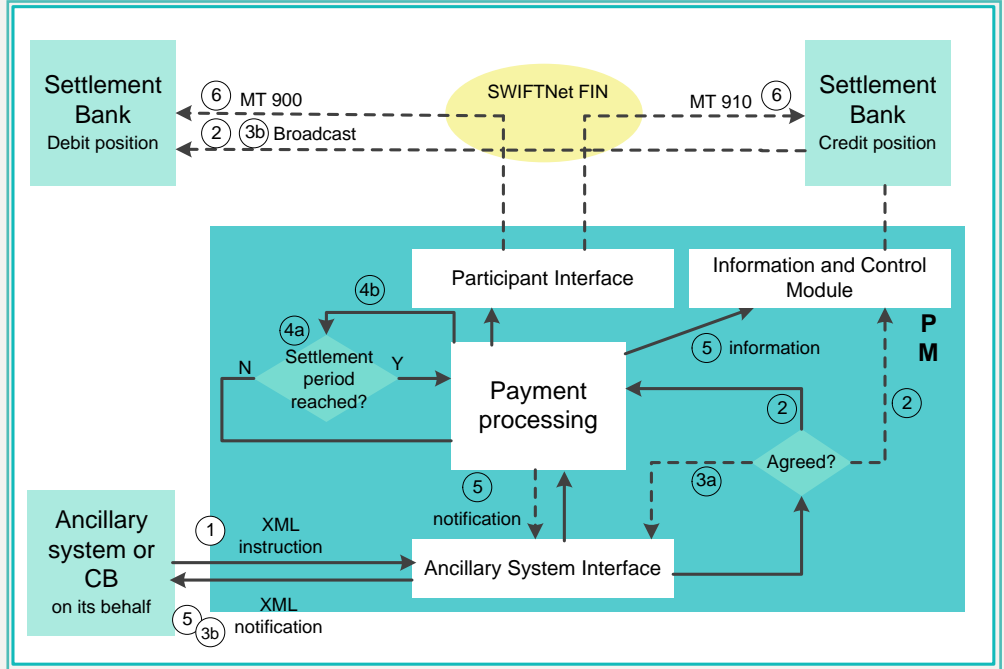

Phase	Step	Description
Initiation	1	The AS (or the relevant CB on its behalf) sends a file with XML messages (ASTransferInitiation) with all transactions to be debited to the “debtor’s” settlement bank’s accounts and to be credited to the “creditor’s” settlement bank’s accounts. The account to be debited and the account to be credited can be the same. The transaction can be executed against the AS technical account (both on the debit and on the credit side). The file header may include the “information period” and the “Settlement period” options (for the format see chapter 9.2.6 Use cases for AS, page 572).
Optional mechanisms	2	If the AS (or the relevant CB on its behalf) has specified the optional “Information period” time, the settlement bank receives via ICM the broadcast notification on the start of the information period.

2 User Guide for Payments Module (PM)

2.8 Settlement of ancillary systems

2.8.2 Work flow of settlement procedures (liq. trans., real-time, bilat., stand. and simult. multilat.)

Phase	Step	Description
		If the settlement bank does not react (the suitable communication means has to be agreed within the contractual relationship with the AS) to its AS (or the CB on behalf) during the information period the processing will continue.
	3a	If the settlement bank “disagrees“ on one or more transactions no settlement is triggered for the pertaining transactions. The relevant CB will revoke the pertaining transactions via the ICM.
	3b	The AS (or the relevant CB on its behalf) and the relevant settlement bank are informed on the settlement failure with a broadcast notification via ICM.
	4a	If the AS (or the relevant CB on its behalf) has indicated a “Settlement period“ time, the PM continuously checks whether the time limit is reached and the AS related AS transaction is still pending. If the time limit is exceeded the settlement fails and the AS transactions not yet settled are rejected. The CB of the AS is allowed to revoke XML transactions that belong to the CB's AS as long as the payments are not final. A broadcast is sent to the AS and to the relevant settlement bank informing the revoked payment.
	4b	The settlement takes place with the debit/credit of the pertinent accounts in PM (either RTGS settlement bank's accounts or AS technical account). Each debit component is checked against the liquidity available in the pertinent accounts in PM (either RTGS settlement bank's accounts or AS technical account). If the liquidity covers the needed amount, the AS transaction is settled (both on the debit and on the credit side). If liquidity is not sufficient the AS transaction is posted in the waiting queue and the settlement bank is informed by a broadcast message delivered by the ICM.
	5	Each AS using procedure 3 has to opt in Static Data for a global notification or for a notification for each single transaction: <ul style="list-style-type: none"> In case of global notification, the AS (or the relevant CB on its

2.8 Settlement of ancillary systems

2.8.2 Work flow of settlement procedures (liq. trans., real-time, bilat., stand. and simult. multilat.)

Phase	Step	Description
		<p>behalf) receives a notification file (ASInitiationStatus) either positive on the entire set of transactions or pertaining to each AS transaction with a list of their results (settled or not or revoked).</p> <ul style="list-style-type: none"> In case of single notification, the AS (or the relevant CB on its behalf) receives as many ASInitiationStatus than the number of transactions contained in the file. With single notification the global status is not significant because ASInitiationStatus is sent immediately when a transaction is settled. Therefore it will be reported as "partially settled" in each single notification. However the number of the ASInitiationStatus to be delivered has to be limited in order to avoid an overloading at the Inter-Act level. Consequently, if the number of transactions exceeds a technical limit, the file will not be settled and the AS will receive a negative notification file (ASInitiationStatus). During the settlement period, an ASInitiationStatus is sent after each settlement of a transaction. At the end of settlement period, an ASInitiationStatus is sent for each transaction rejected for lack of liquidity. In case of revocation of the payment, the AS receives the ASInitiationStatus for the revoked transaction with code status "revoked". <p>Note: If the procedure is used to settle multilateral balances, in case of a settlement failure the already settled debit balances have to be immediately reversed by the AS.</p> <p>At each stage, information on the settlement status are available for settlement banks and ASs through the ICM. In case of settlement failure no notification is sent to the settlement bank.</p>
	6	<p>On an optional basis, the settlement banks of the AS participants are notified in case of successful settlement via the respective MT (MT 900/910). Not possible for Internet-based settlement bank.</p>

2.8.2.4 Standard multilateral settlement

ASs can settle a set of multilateral balances (debits and credits) on RTGS accounts through the ASI in a batch mode. This procedure should be func-

2.8 Settlement of ancillary systems

2.8.2 Work flow of settlement procedures (liq. trans., real-time, bilat., stand. and simult. multilat.)

General aspects

tional for ASs using an interfaced model where the final settlement takes place within the SSP.

The ASI would be responsible for storing all balances and for sending debits first and, only when all debit transactions are settled, for processing credits.

The settlement of the debit leg can benefit from the optimisation mechanism.

In case of failure of debit settlements a “reversing procedure” is triggered by the ASI. This procedure would consist of entering reverse transactions related to all those accounts already debited during the interrupted settlement cycle. So far the AS technical account must be debited against these settlement banks’ RTGS accounts. Pending uncovered debits are simply rejected.

The standard multilateral settlement may include optional connected mechanisms:

- Information period
- Settlement period (“till”)

2 User Guide for Payments Module (PM)

2.8 Settlement of ancillary systems

2.8.2 Work flow of settlement procedures (liq. trans., real-time, bilat., stand. and simult. multilat.)

- Guarantee fund mechanism

To avoid the “reversing procedure“ the “Settlement period“ option could be used together with the provision of a guarantee fund mechanism.

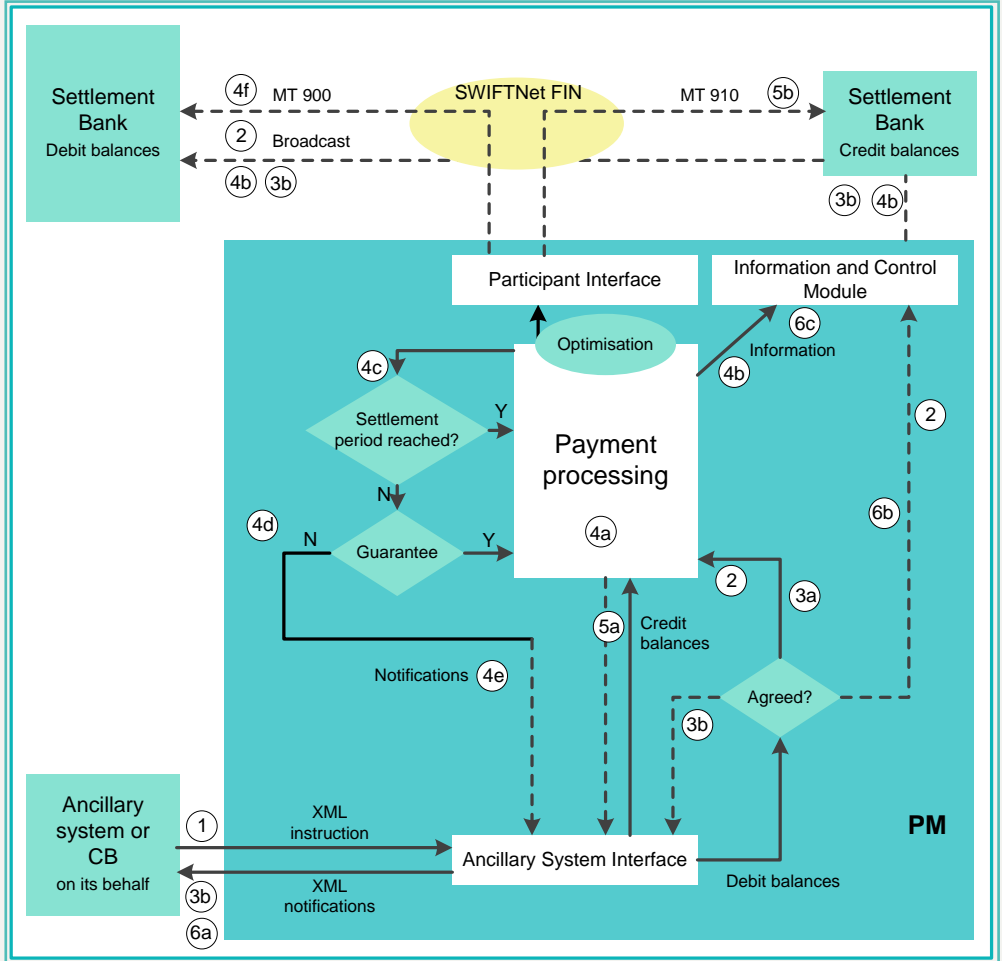

2.8 Settlement of ancillary systems

2.8.2 Work flow of settlement procedures (liq. trans., real-time, bilat., stand. and simult. multilat.)

Phase	Step	Description
Initiation	1	<p>The AS (or the relevant CB on its behalf) sends a file with all multi-lateral balances to be debited and credited on the settlement bank's accounts (ASTransferInitiation, for the format see chapter 9.2.6 Use cases for AS, page 572).</p> <p>The file may include the "Information period", the "Settlement period" options.</p> <p>Debits and credits will be separately sent to the settlement: ASI is responsible for storing credits till the debits settlement has been finished.</p>
Optional mechanisms	2	<p>If the AS (or the relevant CB on its behalf) has specified the optional "Information period" time, the settlement bank receives via ICM the broadcast notification on the start of the information period.</p> <p>If the settlement bank does not react (the suitable communication means has to be agreed within the contractual relationship with the AS) to its AS or the CB on behalf during the information period the processing will continue.</p>
	3a	<p>If the settlement bank "disagrees" no settlement is triggered for the whole file. The relevant CB will revoke the file via ICM.</p>
	3b	<p>All settlement banks and the AS are informed via ICM broadcast about the settlement failure caused by the disagreement.</p>
Settlement (debit positions)	4a	<p>Debits are processed for the settlement. Once they would have been all settled, credits will be processed.</p> <p>The settlement takes place with the debit of the pertinent settlement banks' RTGS accounts in PM against the AS technical account.</p> <p>Each debit transaction is checked against the liquidity available in the pertinent settlement banks' RTGS accounts. If the liquidity covers the needed amount, the AS transaction is booked. If liquidity is not sufficient the AS transaction is posted in the waiting queue.</p>
	4b	<p>The settlement banks are informed on queuing by a broadcast message delivered by the ICM.</p> <p>Immediately after putting the group of debit transactions in the</p>

2 User Guide for Payments Module (PM)

2.8 Settlement of ancillary systems

2.8.2 Work flow of settlement procedures (liq. trans., real-time, bilat., stand. and simult. multilat.)

Phase	Step	Description
		queue the optimisation process starts (algorithms 1, 2 and 3). Pending AS transactions are settled by resolving the queue. The CB of the AS is allowed to revoke files that belong to the CB's AS as long as they are not final. A broadcast is sent to the AS and to all the settlement banks informing the revoked payment.
	4c	If the AS (or the relevant CB on its behalf) has indicated a "Settlement period" time, the PM - if related payments are still pending - continuously checks whether the time limit is reached. If the time limit is exceeded, and guarantee fund mechanism are not envisaged, the settlement fails and the whole file is rejected. Consequently the ASI will trigger the reversing procedure. From the SSP point of view the reversing is similar to the settlement of the credit positions where the AS technical account has to be debited in return of the settlement banks' RTGS accounts (only those debited during the interrupted settlement cycle).
	4d	If the time limit is exceeded and the guarantee fund mechanism has been envisaged, "Guarantee fund mechanism" will be available for the CB and can be activated according to the agreed procedures.
	4e	After all debit transactions have been settled the ASI is notified to proceed with the credits settlement.
	4f	On an optional basis, the settlement banks of the AS participants are notified in case of successful settlement via MT 900. Not possible for Internet-based settlement bank.
Settlement (credit positions)	5a	ASI sends credits to the payment processing, after all credit transactions are settled, the ASI is notified.
	5b	On an optional basis, the settlement banks of the AS participants are notified in case of successful settlement via MT 910. Not possible for Internet-based settlement bank.

2.8 Settlement of ancillary systems

2.8.2 Work flow of settlement procedures (liq. trans., real-time, bilat., stand. and simult. multilat.)

Phase	Step	Description
Notification	6a	After all transactions have been booked the AS (or the relevant CB on its behalf) receives a notification file (ASInitiationStatus, for the format see chapter 9.2.6 Use cases for AS, page 572) pertaining the entire set of transactions. In case of revocation of the file, the AS receives the ASInitiationStatus with code status "revoked".
	6b	Only in case of settlement failure the ASI informs via ICM all the settlement banks with a broadcast message.
	6c	At each stage, information are available for settlement banks and ASs through the ICM.

2.8.2.5 Simultaneous multilateral settlement

ASs can settle a set of multilateral balances (debits and credits) on RTGS accounts through the ASI in a batch mode.

The simultaneous multilateral settlement may include optional connected mechanisms:

- Information period
- Settlement period ("till")
- Guarantee fund mechanism

Ancillary system balances to be settled under the simultaneous multilateral settlement mechanism are presented to the PM for settlement at an "entry time" which is the latest of the following two instances:

- as soon as they are received through the Ancillary System Interface.
- the end of the "information period" if such a period was specified and no disagreement was received.

The settlement of both debits and credits can benefit from the optimisation mechanism with a specific algorithm, the algorithm 4.

General aspects

2 User Guide for Payments Module (PM)

2.8 Settlement of ancillary systems

2.8.2 Work flow of settlement procedures (liq. trans., real-time, bilat., stand. and simult. multilat.)

Algorithm 4 offers an efficient and fast processing of the related AS transactions. To smooth the settlement and to reduce the liquidity needed; it is checked that all transactions of an involved AS are settled at once (“all or nothing”) taking also normal and urgent payment on board.

The settlement occurs only if all needed funds have been blocked. If not, new attempts of settlement will be made till the end of the settlement period has been reached.

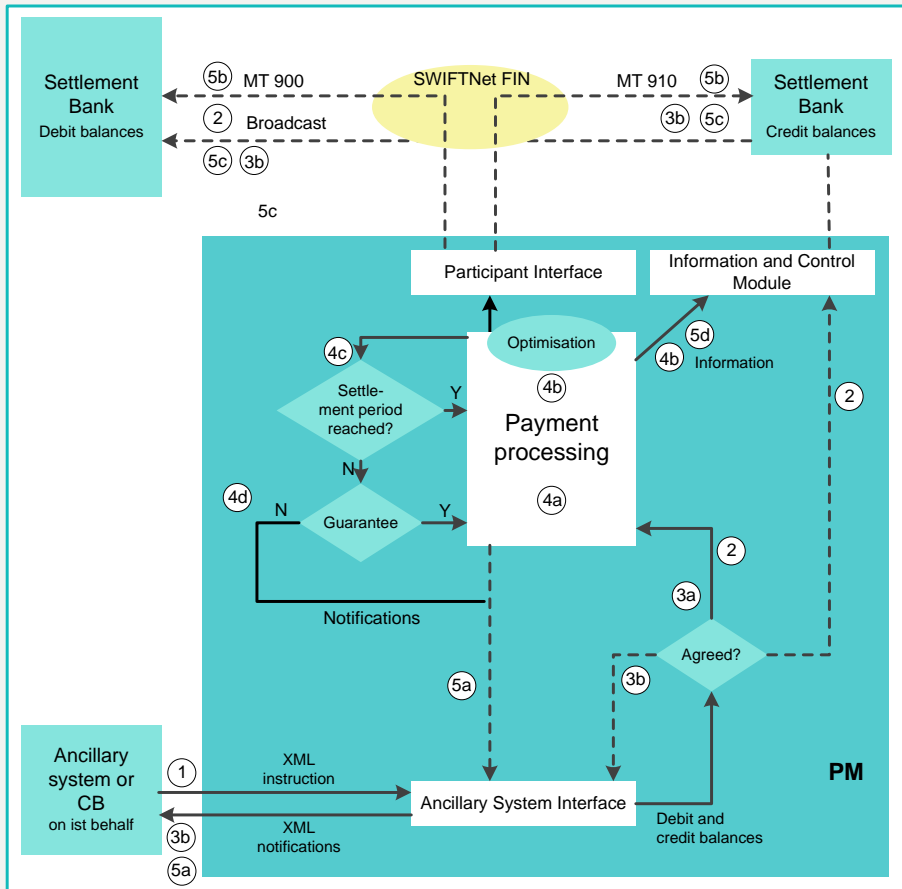

2 User Guide for Payments Module (PM)

2.8 Settlement of ancillary systems

2.8.2 Work flow of settlement procedures (liq. trans., real-time, bilat., stand. and simult. multilat.)

Phase	Step	Description
Initiation	1	<p>The AS (or the relevant CB on its behalf) sends a file with all multi-lateral balances to be debited and credited on the settlement bank's accounts (ASTransferInitiation, for the format see chapter 9.2.6 Use cases for AS, page 572).</p> <p>The file may include the "Information period" and the "Settlement period" time options.</p>
Optional mechanisms	2	<p>If the AS (or the relevant CB on its behalf) has specified the optional "Information period" time, the settlement bank receives via ICM the broadcast notification on the start of the information period.</p> <p>If the settlement bank does not react (the suitable communication means has to be agreed within the contractual relationship with the AS) to its AS (or the CB on behalf) during the information the processing will continue.</p>
	3a	<p>If the settlement bank "disagrees" no settlement is triggered for the whole file. The relevant CB will revoke the file via ICM.</p>
	3b	<p>All settlement banks and the AS are informed via ICM broadcast about the settlement failure caused by the disagreement.</p>
Settlement	4a	<p>Debits and credits are jointly sent to the waiting queue mechanism and the optimisation process (algorithm 4 see chapter 2.7.3 Dissolution of payment queue, page 155) starts.</p> <p>If the liquidity covers the needed amount, the transactions are booked.</p>
	4b	<p>If liquidity is not sufficient:</p> <ul style="list-style-type: none"> all the settlement banks are informed on queuing by a broadcast message delivered by the ICM algorithm 4 runs iteratively until all debit positions are covered and all AS transactions can be booked together <p>The related CB has the possibility through monitoring screens to determine which settlement bank(s) has not enough liquidity. The CB of the AS is allowed to revoke files that belong to the CB's AS as long as they are not final. A broadcast is sent to the AS and to all the settlement banks informing the revoked payment.</p>

2 User Guide for Payments Module (PM)

2.8 Settlement of ancillary systems

2.8.2 Work flow of settlement procedures (liq. trans., real-time, bilat., stand. and simult. multilat.)

Phase	Step	Description
	4c	If the AS (or the relevant CB on its behalf) has indicated a "Settlement period" time, the PM - if related payments are still pending - continuously checks whether the time limit is reached. If the time limit is exceeded and the guarantee fund mechanism is not envisaged, the settlement fails and the whole file is rejected.
	4d	If the time limit is exceeded and the guarantee fund mechanism has been envisaged, "Guarantee fund mechanism" will be available for the CB and can be activated according to the agreed procedure. If it is the case the ASI change the file's settlement procedure in standard multilateral and re-enters the debits only. If the settlement attempt is not totally successful the ASI initiates the procedure described in the following chapter under the title "guarantee funds mechanism".
Notification	5a	After transactions have been all booked or all rejected the AS (or the relevant CB on its behalf) receives an XML message (ASInitiationStatus, for the format see chapter 9.2.6 Use cases for AS, page 572) a notification pertaining the entire set of transactions. In case of revocation of the file, the AS receives the ASInitiationStatus with code status "revoked".
	5b	On an optional basis, the settlement banks of the AS participants are notified in case of successful settlement via the respective MT (MT 900/910). Not possible for Internet-based settlement bank.
	5c	Only in case of settlement failure the ASI informs via ICM all the settlement banks with a broadcast message.
	5d	At each stage, information are available for settlement banks and ASs through the ICM.

2.8.2.6 Optional connected mechanisms

General aspects

At the end of this chapter some additional information is provided on the batch optional connected mechanism already roughly described.

To make use of this mechanisms the AS has to fill in a specific field provided in the file header.

Only the AS (or the CB acting on its behalf) is empowered to insert these parameters in the file. Once a file is sent the parameters can be updated via ICM (in U2A mode):

- By the AS for optional mechanism “Settlement period“ before the inserted “till“ time has been expired
- By the settlement bank only for optional mechanism “Scheduled time“ before the inserted “from“ time has been reached (procedures 1 and 2)

“Information period“ and “Guarantee fund mechanism“ parameters can be updated neither by the AS nor by the settlement banks.

Information period

The information period option allows settlement banks to a more efficient liquidity management giving the possibility of knowing in advance the liquidity needed for the settlement of a specific AS's balances.

Only in a very few circumstances a settlement bank is moreover legitimate to express disagreement on the specified balance before the settlement takes place. The business rules and the condition to be verified for expressing disagreement have to be defined by the AS and the relevant CB. The reasons for disagreement are not checked by the SSP.

- The ASI sends a broadcast notification to the settlement banks when the information period starts.
- If the settlement bank does not react during the whole information period the settlement takes place following the selected settlement procedure.
- If the settlement bank reacts (the suitable communication means has to be agreed within the contractual relationship with the AS) the settlement fails. The CB of the AS has to revoke the disagreed balances (bilateral

2 User Guide for Payments Module (PM)

2.8 Settlement of ancillary systems

2.8.2 Work flow of settlement procedures (liq. trans., real-time, bilat., stand. and simult. multilat.)

Scheduled time (“from“)

settlement) or the whole file (standard and simultaneous multilateral settlement) using a specific ICM function.

The settlement of individual transactions (“Liquidity transfer“ and “Real-time Settlement“) can take benefits from the use of a “from“ option. From the settlement point of view it is very close to the “Information period“ option: in both cases the settlement is deferred to a specific time (from) or at the end of a period (information period).

The main difference between the two options are:

	Information period	Scheduled time (“from“)
References	being batch oriented is referred to the whole set of transactions	being real-time oriented is referred to the individual transaction
Processing	The file incorporating an information period is maintained in the ASI till the period ends (the pertaining transactions are therefore not queued till the information period ends).	The transactions with a from option are immediately sent to the payment processing but they are delivered to the entry disposition only when the “from“ is reached.
Modifiability	Once the file has been sent the information period is modifiable neither by the AS nor by the settlement banks.	The from option, if any, can be changed via ICM but only by the settlement bank of the debtor side.

Settlement period (“till“)

The settlement of an AS may only take a pre-defined period of time. If the settlement is not completed successfully during this period of time the transactions are rejected or a guarantee fund mechanism is activated.

The AS, accordingly on rules established at national level, can modify the end of the settlement period (“Change Settlement Period“ on ICM) before it has been expired.

ASs are expected to use the settlement period option to avoid the extension of the arranged settlement timeframe. In case the option is not used the un-

2.8 Settlement of ancillary systems

2.8.2 Work flow of settlement procedures (liq. trans., real-time, bilat., stand. and simult. multilat.)

settled transactions are queued and no additional services are performed on their settlement processing. The control on the whole process becomes looser and the final notification on the whole set of transactions will be sent to the AS either when the last balance has been settled or when the end-of-day queues cancellation occurs.

The guarantee fund mechanism (if foreseen by the AS) could be used when a settlement failure occurs to provide the needed liquidity.

This optional mechanism can be used only:

- In relation to a multilateral (both standard and simultaneous) procedure
- Together with “Settlement period“ time option

Guarantee fund mechanism

2 User Guide for Payments Module (PM)

2.8 Settlement of ancillary systems

2.8.2 Work flow of settlement procedures (liq. trans., real-time, bilat., stand. and simult. multilat.)

The guarantee fund mechanism is based on a guarantee account where the liquidity is collected to support the AS settlement procedure - either continuously or arranged shortly before.

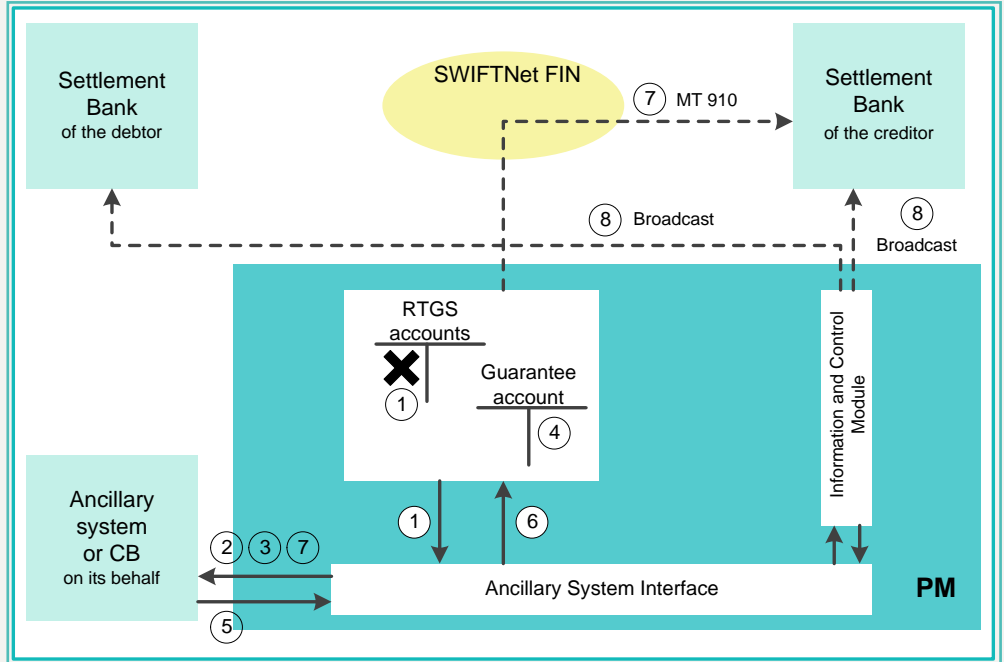

Phase	Step	Description
Settlement failure	1	If the "Settlement period" time is indicated and the settlement is not yet achieved when the allotted time is exceeded the settlement fails.
	2	The settlement failure is notified to the AS via an XML message (ASInitiationStatus) (for the format see chapter 9.2.6 Use cases for AS, page 572).
Guarantee	3	If the guarantee fund mechanism has been envisaged the ASInitia-

2.8 Settlement of ancillary systems

2.8.2 Work flow of settlement procedures (liq. trans., real-time, bilat., stand. and simult. multilat.)

Phase	Step	Description
fund mechanism		tionStatus contains the request to confirm the use of the guarantee fund mechanism (for the format see chapter 9.2.6 Use cases for AS, page 572).
	4	At this moment, depending on the guarantee schema either the collection of the needed liquidity could have been granted in advance by the AS (ie prefunding) or AS has to co-ordinate the liquidity collection making it available on the specific "guarantee" account. In any case, before the guarantee fund mechanism starts the AS has to assure the existence of the needed liquidity on the guarantee account.
	5	The AS sends an XML message (Receipt) to give either a positive or a negative confirmation in order to proceed or not with a new settlement phase against the guarantee account. If the receipt is sent twice, the second message is rejected.
New settlement phase	6	If the AS confirms the actual use of the guarantee fund mechanism the ASI re-enters the transactions for which the liquidity was missing in order to be settled on the guarantee account by substituting the debtor settlement bank account number into the file with the AS guarantee account number.
	7	In case of sufficient liquidity the settlement takes place and the AS is notified of the ending of the whole settlement procedure. On an optional basis, the settlement banks of the creditor side are notified with MT 910 if the settlement bank is not an Internet-based settlement bank.
	8	If the AS sends a negative confirmation or there is a lack of liquidity on the guarantee account the "reversing procedure" is initiated (only in case of settlement procedure no. 4). The ASI informs via ICM all the settlement banks with an ICM broadcast.

2.8 Settlement of ancillary systems

2.8.3 Work flow of “dedicated liquidity” settlement procedure

2.8.3 Work flow of “dedicated liquidity” settlement procedure

2.8.3.1 General aspects

Ancillary systems which run settlement procedures based on the confidence of a liquidity “fixed” amount can benefit from a pre-funding function that allows settlement banks to set aside the needed liquidity in one or more than one separate sub-accounts dedicated to a specific ancillary system.

The settlement procedure 6 must therefore be used to settle balances for an amount equal to or lower than the set aside liquidity.

Furthermore, to avoid liquidity shortages, as far as interfaced AS settlement procedures are concerned, automatic mechanisms triggered by specific transactions for increasing the already set aside liquidity (ie redemption and coupon payments or payments related to auto-collateralisation) are foreseen.

Settlement on dedicated liquidity is a very convenient functionality to provide liquidity in batch-mode either for the interfaced settlement model or for the real-time settlement model. During the night-time business, after the re-opening of the SSP with next value date, the liquidity adjustment mechanisms - provided within the dedicated liquidity procedure - are the only opportunity to supply liquidity without any impact on reserve management and overnight facilities, as regular payment functionality (through the payment interface) is not available from 18.00 till 7.00.

A settlement bank can use this settlement procedure with reference to several ancillary systems.

As already mentioned settlement on dedicated liquidity is suitable both for real-time and interfaced ASs.

- In case of real-time models, where the settlement occurs on the SSP, the pertinent ancillary system has to use its technical account - procedure 6 real-time to collect the liquidity set aside by its settlement banks and to mirror it in the cash positions within its own system.

Accounting

2.8 Settlement of ancillary systems

2.8.3 Work flow of “dedicated liquidity” settlement procedure

- In case of interfaced models, where the settlement takes place in the SSP, the settlement bank has to open at least one sub-account related to a single ancillary system.

A sub-account is identified by the BIC of the related RTGS account in combination with an account number that is specific for the sub-account. Only direct PM participants can hold such a sub-account. In case the PM participant belongs to a virtual account, the funds set aside on dedicated sub-accounts are not consolidated by the liquidity pooling functionality.

The settlement banks wishing to segregate in distinct cash position their settlement business have to open also more than one sub-account for each ancillary system.

Procedures and cycles

Settlement with dedicated liquidity is a standardised procedure for daylight and night-time business.

Daylight and night-time businesses are operated in so-called procedures and cycles.

Depending on business day phase the daylight procedure/cycle and the night-time cycle can be opened by messages or ICM screen.

The daylight and night-time procedure/cycle can be closed by messages or via ICM screen.

2 User Guide for Payments Module (PM)

- 2.8 Settlement of ancillary systems
- 2.8.3 Work flow of “dedicated liquidity” settlement procedure

Daylight procedures are running during the Day Trade Phase, the night-time procedure runs between the start of a new business day and the next Day Trade Phase.

With the “start of procedure message” the standing orders (see below) are executed, the liquidity is therefore transferred from the settlement banks’ RTGS accounts to the technical account – procedure 6 real-time (real-time model) or sub-accounts (interfaced model).

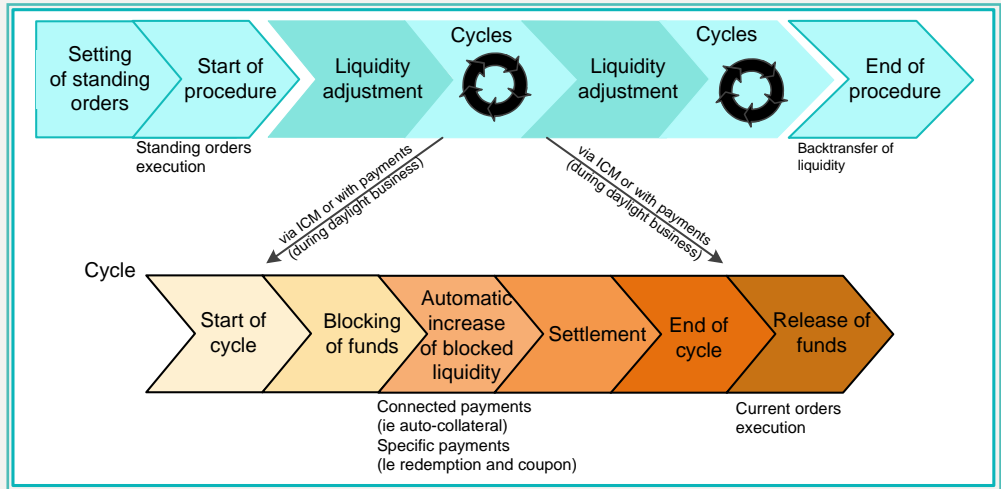

With the “end of procedure message” (ReturnGeneralBusinessInformation) the remaining liquidity on sub-accounts (interfaced model) is transferred back to the settlement banks’ RTGS accounts (no transfer back for technical account - procedure 6 real-time – real-time model).

It is not possible for any AS using the ASI procedure 6 real-time to close the night-time settlement procedure. TARGET2 will automatically open the night-time settlement procedure at 19:30h at D (unchanged). TARGET2 will automatically close the night-time settlement procedure at 18:00h at D+1, without any intervention by the AS.

Within a procedure several cycles could run consecutively. Before a cycle is started, a certain period of time for liquidity transfers between RTGS and

sub-accounts or between RTGS and technical account - procedure 6 real-time shall be foreseen.

Between two cycles a timeframe to allow liquidity adjustment is foreseen, each cycle is structured as follows:

- A specific message declares the starting of the cycle (ReturnGeneralBusinessInformation).
- During the settlement cycle the dedicated liquidity is consequently blocked. Possible current orders (see below) received during the cycle are stored within ASI and they will be executed immediately after the end of cycle message. For daylight processing only, possible payments (ie sent through MT 202 with priority “highly urgent”) received during a cycle to transfer liquidity from the RTGS account to the technical account - procedure 6 real-time (real-time model) or a specific sub-account (interfaced model) are immediately executed. If when registering to TARGET2 the AS has opted for the notification, the AS is immediately notified of the transfer by a ReturnAccount which contains the amount credited (“PYMT”) and the new balance on the sub-account (“BOOK”). The option “FROTIME” (field 13C) is ignored.
- The liquidity deposited on a dedicated account can be further increased via automatic treatment of specific payment orders (see chapter [2.8.3.2.2 Night-time business: interfaced model, page 232](#), automatic increase of blocked liquidity by auto-collateralisation).
- Settlement instructions are processed while optimisation mechanism is running.
- A specific message states the end of cycle (ReturnGeneralBusinessInformation).
- At the end of the settlement process, the (remaining) dedicated liquidity is released but kept in the sub-account to be available for possible further cycles.
- Current orders (see below) received during the cycle, if any, are executed after the end-of-cycle message.

2.8	Settlement of ancillary systems
2.8.3	Work flow of “dedicated liquidity” settlement procedure

- With the AS procedure 6 real-time, it is no longer necessary to open a cycle to submit a “Cross AS settlement” transaction. However, since the cycle functionality is not removed from the ASI procedure 6 real-time, if an AS opens a cycle, then this AS has to be aware that the liquidity will be blocked until the cycle is closed again, except for MT 202 with priority "highly urgent" during daylight processing (Reminder: no other liquidity adjustment is possible during open cycles).

The rejection of all control messages (start/end of cycle/procedure) is expressed by ASI using the XML message Receipt.

This general workflow has variants depending on the phases of the business day (daylight or night-time) and on the nature of the AS (interfaced or real-time), which are described in further detail in chapter [2.8.3.2 Night-time business, page 222](#) and chapter [2.8.3.3 Daylight business, page 254](#).

Provided tools to set aside liquidity

In order to set aside liquidity on technical account - procedure 6 real-time (real-time model) or sub-accounts (interfaced model) several options are provided:

- **Standing orders**

Standing orders are instructions of a settlement bank to transfer regularly a fixed amount from its RTGS account to the technical account - procedure 6 real-time (real-time model) or a specific sub-accounts (interfaced model).

Standing orders can be inserted and modified via ICM both in user-to-application and application-to-application mode (in the latter case ModifyStandingOrder to store the amount in Static Data Module). As a consequence standing orders can neither be inserted nor modified when the ICM is not available (ie between the end-of-day and the opening of the next business day).

Standing orders are automatically executed immediately after the start of procedure message; as a consequence standing orders inserted or modified during a procedure processing are taken into account only at the next business day.

Each settlement bank can set different standing orders to sub-accounts (interfaced model) for night-time and daylight procedure.

However, for any AS using the AS procedure 6 real-time, be aware that no daylight procedure with additional standing orders will be available any more (since it is no longer possible for any AS using the AS procedure 6 real-time to close the night-time procedure). Therefore, only one standing order per business day can be set for this procedure. It is executed with the start of night-time processing.

In case of sub-accounts (interfaced model) a settlement bank has the possibility to open several sub-accounts in order to eg separate own business and third-party business. For each sub-account the settlement bank can define two standing order liquidity transfers (one for daylight and one for night-time processing).

Only the settlement bank can set standing orders; the AS cannot instruct standing orders to credit the technical account - procedure 6 real-time or sub-accounts related to it.

- **Current orders**

Current orders are instructions entered either by a settlement bank or the pertinent AS on its behalf to perform an immediate liquidity transfer from the settlement bank’s RTGS account to the AS technical account - procedure 6 real-time (real-time model) or the settlement bank’s specific sub-account (interfaced model).

Current orders can be inserted via ICM both in user-to-application and application-to-application mode (in the latter case SBTransferInitiation for real-time model and LiquidityCreditTransfer for interfaced model messages are used) by settlement banks. ASs can insert current orders via ASI using the proper XML message (ASTransferInitiation).

Current orders are executed immediately if received between two cycles (liquidity adjustment phase); as a consequence current orders received during a cycle processing are stored to be taken into account only immediately after at the end of cycle message according to the FIFO principle. Current orders received after an end of procedure message (out of the procedure timeframe) are immediately rejected (notification ASInitiation-Status).

If the liquidity on the RTGS account or on the sub-account is insufficient to cover the current order sent by the AS, the order is partially executed

(ie up to the available liquidity on the RTGS account or on the sub-account concerned). The remaining part will not be settled. Current orders can be used both for night-time and daylight procedure. It is also possible to insert more than one current order for a specific technical account - procedure 6 real-time (real-time model) or for each specific sub-account (interfaced model).

Current orders can also be used to withdraw liquidity from the sub-account (interfaced model) to the main account. This is not possible in the real-time model as the technical account - procedure 6 real-time is held by the CB or AS and not by the settlement bank. A transfer to main account should be initiated in the AS in the real-time model.

- **Payments**

Eventually - for daylight processing only - the liquidity can be transferred from the RTGS account to the technical account - procedure 6 real-time (real-time model) or a specific sub-account (interfaced model) using the normal payment functionality via MT 202. The reverse transaction is not allowed. The MT 202 (priority “highly urgent“ has to be used) has to be addressed to a specific BIC of the PM (see chapter [9.1.1.1 Business Identifier Codes \(BICs\) for SSP, page 409](#)) with the reference of the account in field 58 (sub-account)/field 57 (technical account - procedure 6 real-time). The settlement bank receives a debit notification (MT 900) for the debit on the RTGS account.

Note: Payments via MT 103 and MT 202 to technical accounts - procedure 6 real-time should not be sent as normal business but in contingency situations only.

Payments received during a procedure, but out of the cycle timeframe, are executed and notified immediately.

2 User Guide for Payments Module (PM)

- 2.8 Settlement of ancillary systems
- 2.8.3 Work flow of “dedicated liquidity” settlement procedure

Payments received during a cycle processing are immediately executed. In case of payment to sub-account (interfaced model) the AS is notified immediately by a ReturnAccount if it has opted for the notification.

Payments for interfaced models received after an end of procedure message (out of the procedure timeframe) are rejected.

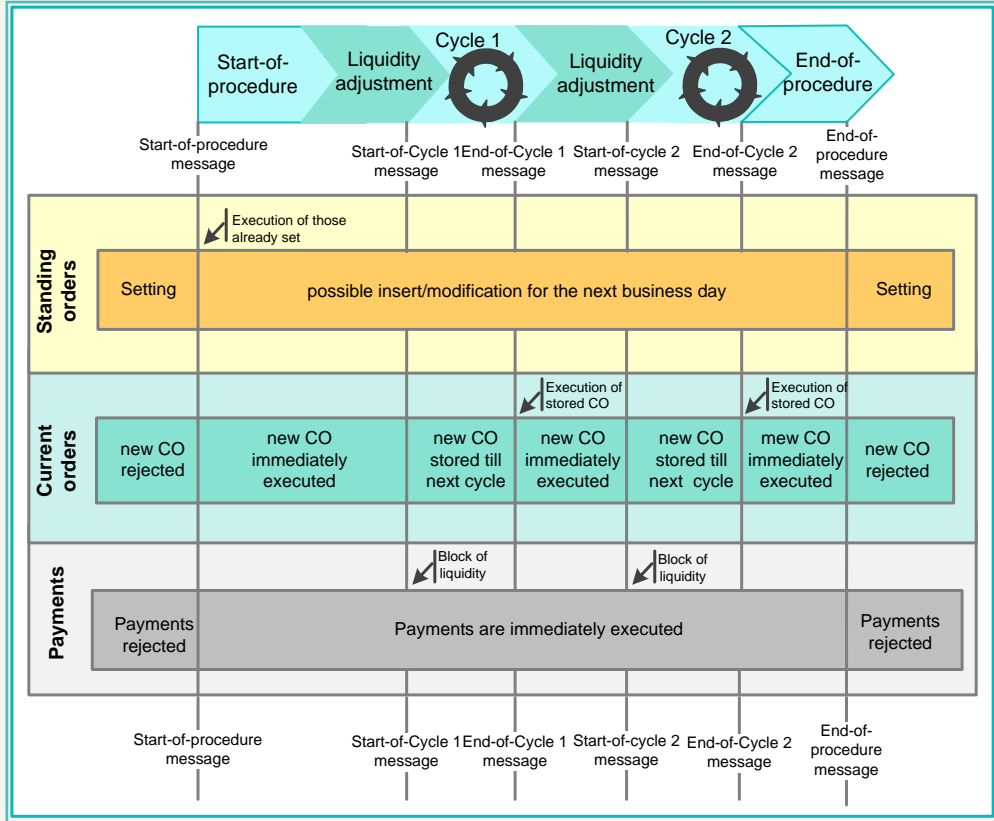

2.8 Settlement of ancillary systems

2.8.3 Work flow of “dedicated liquidity” settlement procedure

2.8.3.2 Night-time business

The night-time procedure workflow has relevant relation with the end-of-day and start-of-day procedures needed in the SSP to close the current business day and open the new one.

As a consequence the night-time procedure has, compared with the daylight one, the following peculiarity:

- The night-time procedure benefits from an automatic start of procedure message sent by the ASI itself after the end-of-day processing and the following re-opening of next business day.
- After the re-opening of the new business day, several cycles can be performed within the night-time procedure, with an interruption on the SSP site needed for technical reasons.
- Payments (MT 202) cannot be used to transfer liquidity from the RTGS account to the technical account - procedure 6 real-time (real-time model) or a specific sub-account (interfaced model).

A pre-requisite for night-time business is the re-opening of the SSP with next value date.

As a consequence all procedures stemming from the closing day have to be completed before the re-opening takes place. In case one AS does not close its daylight procedure by itself (interfaced model), it will be forced closed by the ASI. This processing ensures that there is no impact on minimum reserve requirements and standing facilities management. As for the real-time model, AS cannot close the procedure that is always closed by the ASI with notification to the AS.

To this aim, the assessment of reserve requirements and the standing facilities management will occur during the end-of-day procedures before the transfer of liquidity from RTGS accounts to sub-accounts takes place.

If reserve management and/or standing facilities are managed on proprietary home accounts and liquidity on RTGS accounts was transferred to PHA during end of day processing of SSP, these balances (including standing facilities) must be transferred back to RTGS accounts before night-time cycle

2.8 Settlement of ancillary systems

2.8.3 Work flow of “dedicated liquidity” settlement procedure

(and the consequent blocking function) starts as far as end-of-day procedure are concerned.

Note: Also during the night liquidity transfers between CSDs are in principle possible. This means that an AS has to credit the account of another AS. This is possible if the second AS has opened an RTGS account (no technical account) and a sub-account and has been declared as settlement bank of the first AS.

2.8.3.2.1 Night-time business: real-time model

The peculiarity of the settlement procedure on dedicated account when applied to AS based on real-time accounts system is that the liquidity transfer from the participant’s RTGS account is sent directly to a technical account - procedure 6 real-time operated by the AS.

The standing orders can be posted by the settlement banks (via ICM).

Settlement banks, via ICM, can

- place standing order.

Setting of standing orders, liquidity adjustment and start of cycle

2 User Guide for Payments Module (PM)

- 2.8 Settlement of ancillary systems
- 2.8.3 Work flow of “dedicated liquidity” settlement procedure

- increase the amount of dedicated liquidity using current orders once the start of procedure message has been sent.

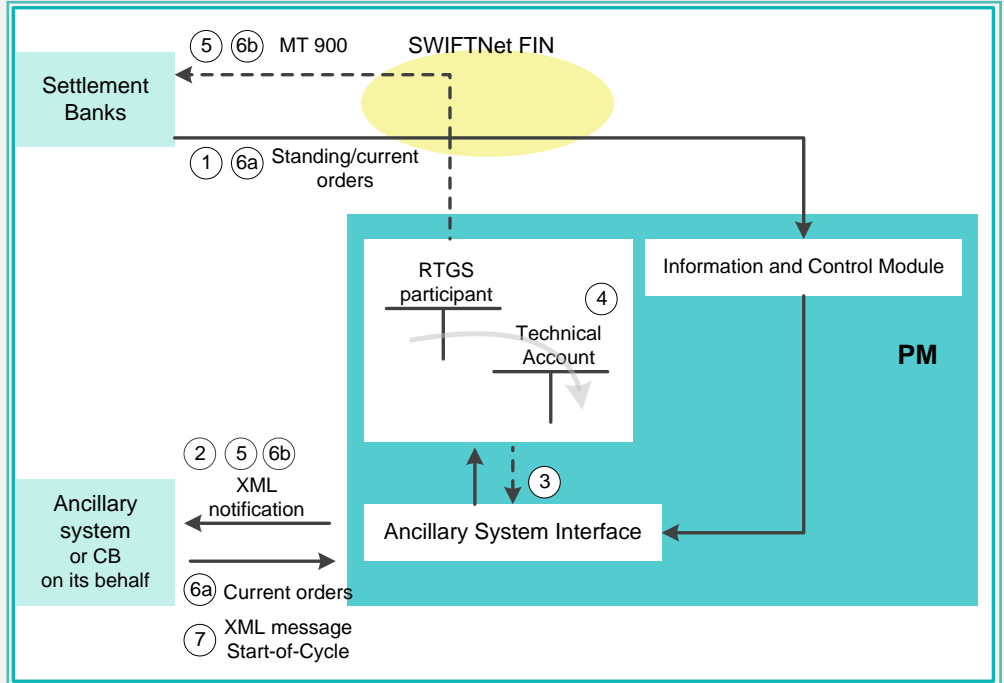

Phase	Step	Description
Setting of standing orders	1	During the business day it is possible for a settlement bank to determine the liquidity input for the forthcoming night-time business. A settlement bank can set several standing orders (ModifyStandingOrder to store the amount in the Static Data module) for a specific AS against its RTGS account (eg to separate own business and third-party business). Changes of standing orders in ICM will always become effective in the next business day.
Start of procedure	2	Start of procedure message is automatically initiated by ASI after re-opening of new business day. The AS will be notified on the

2 User Guide for Payments Module (PM)

2.8 Settlement of ancillary systems

2.8.3 Work flow of “dedicated liquidity” settlement procedure

Phase	Step	Description
		event (ReturnGeneralBusinessInformation).
Standing orders execution	3	The start of procedure message triggers the execution of existing standing orders debiting settlement bank’s RTGS account and crediting the pertaining technical account - procedure 6 real-time.
	4	The liquidity transfer takes place. If the total sum of all standing orders of a settlement bank is larger than the liquidity on its RTGS account (cash & credit line), all standing orders will be reduced in a pro-rata mode, ie the existing liquidity is divided by the total sum of standing orders and the resulting factor will be used to reduce each standing order of this participant.
	5	On an optional basis, the settlement banks receive the debit notification on the RTGS accounts (MT 900). Not available for Internet-based settlement banks. XML notifications (ASTransferNotice) for each individual credit of the technical account - procedure 6 real-time are sent to the AS for the amounts actually booked.
Liquidity adjustment	6a	In addition current orders that are stored in the AS can be sent by the AS (ASTransferInitiation) via ASI (the AS cannot set standing order on behalf of its settlement bank, to provide such a functionality the AS has to store and manage in its own procedure outside the SSP any potential standing orders and send them at the appropriate time as current orders). Settlement banks can also instruct current orders via ICM either in A2A with XML SBTransferInitiation or in U2A with the screen Liquidity Transfer to technical account - procedure 6 real-time. In A2A, the settlement bank receives a technical receipt.
	6b	Current orders will be <ul style="list-style-type: none"> • immediately executed. • notified to the settlement bank (not to the Internet-based settlement bank) (MT 900) (optional) • notified to the AS: <ul style="list-style-type: none"> — with XML ASTransferNotice when the settlement bank has

2 User Guide for Payments Module (PM)

2.8 Settlement of ancillary systems

2.8.3 Work flow of “dedicated liquidity” settlement procedure

Phase	Step	Description
		<p>issued the current order</p> <ul style="list-style-type: none">– with XML ASInitiationStatus when the AS has issued the current order. <p>If the liquidity on the RTGS account is insufficient to cover the current order, it is:</p> <ul style="list-style-type: none">• partially executed (ie up to the available liquidity on the RTGS account concerned) if it was sent by the AS. If several orders were sent simultaneously for the same settlement bank, they are executed in the same order as in the AS message up to the available liquidity, and the last order that is not rejected is partially executed. In case there is no liquidity available at all, the amount is reported as zero (0) euro.• rejected if it was sent by the settlement bank. <p>In case a highly urgent payment is pending in queue and has been submitted earlier than the current order, the current order will be rejected.</p>
Start of cycle	7	<p>Once the start of cycle message has been sent the incoming liquidity transfers will not be any longer immediately executed. The AS is notified on the amount actually credited (ASReturnAccount). It is not necessary anymore to open a cycle when ASI 6 real-time procedure is used.</p>

2 User Guide for Payments Module (PM)

2.8 Settlement of ancillary systems

2.8.3 Work flow of “dedicated liquidity” settlement procedure

Phase	Step	Description
Running cycle		As far as blocking of funds, automatic increase of the blocked liquidity and settlement phases are concerned being internal steps of the real-time ASs process no details are herewith provided.
End of cycle		AS can send an XML “end of cycle” message via ASI (ReturnGeneralBusinessInformation) for example to make it possible the execution of new current orders. Possible current orders received during the cycle will be indeed stored till the end of cycle and immediately executed just after it. The “End of Cycle” instruction can also be posted through the ICM in U2A mode. Reverse liquidity transfers and current orders issued by the AS aiming at debiting the technical account - procedure 6 real-time and crediting the participant’s RTGS account are also possible to allow the reallocation of the liquidity in favour of other settling ASs. Current orders received between two cycles are immediately executed.
Liquidity release		The ASI releases the remaining liquidity and notifies the AS through ReturnGeneralBusinessInformation. Possible current orders received during the cycle are executed. A new cycle can be possibly triggered by the AS.

Cross-AS settlement from Real-time AS to Interfaced AS

Cross-AS is a single payment sent with an ASTransferInitiation by an AS (AS1 or its CB on behalf) to debit the technical account - procedure 6 real-time on behalf of a settlement bank in order to credit the sub-account of one of the participants of another AS (AS2). The reverse transaction is not allowed. Although this feature is rather intended for overnight business it is also available in daylight procedure.

AS2 receives a notification (ASTransferNotice) on the incoming liquidity to the sub-account including the information of the resulting balance. AS2 has the possibility to use immediately this credit.

2 User Guide for Payments Module (PM)

- 2.8 Settlement of ancillary systems
- 2.8.3 Work flow of “dedicated liquidity” settlement procedure

A bilateral agreement between AS1 and AS2 is a precondition to use Cross-AS settlement. This agreement has to be input in SD by the relevant CBs.

The cross-AS transaction can be sent during an open procedure of AS1 and AS2. The settlement is executed immediately regardless of the cycle status of AS1 and AS2.

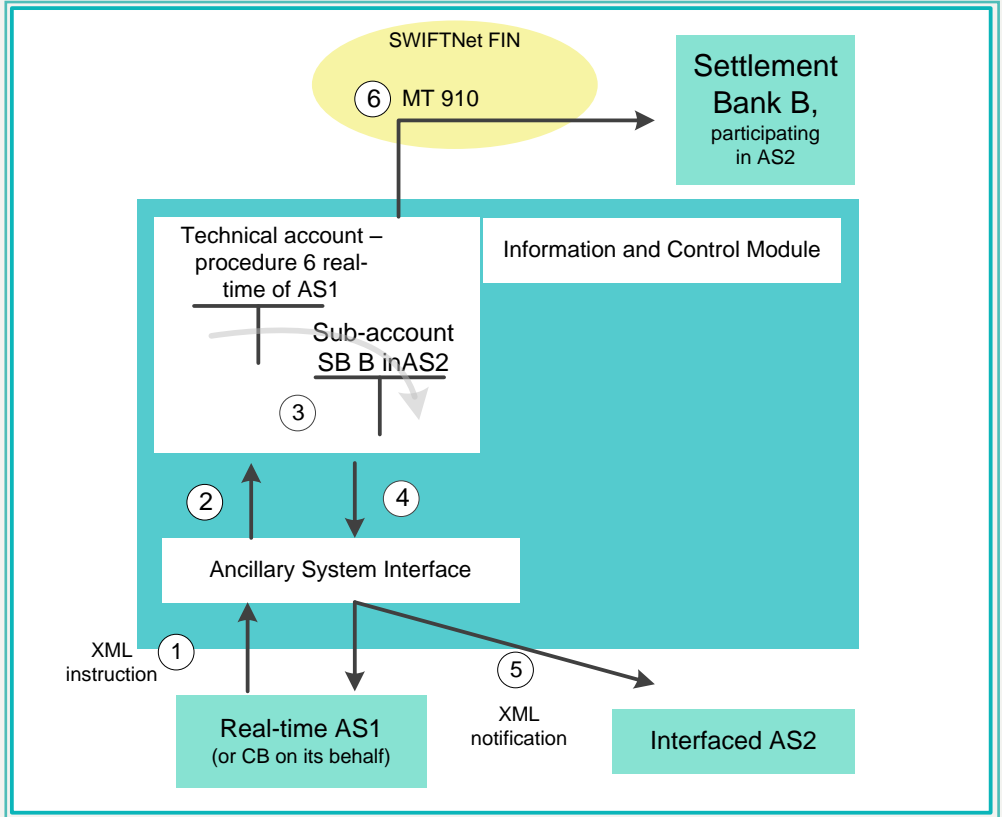

2 User Guide for Payments Module (PM)

2.8 Settlement of ancillary systems

2.8.3 Work flow of “dedicated liquidity” settlement procedure

Phase	Step	Description
Initiation	1	Request of Cross-AS settlement AS1 (or its CB on its behalf) sends an XML message (ASTransferInitiation) with a single payment to transfer liquidity from the technical account - procedure 6 real-time of AS1 on behalf of SB A to the sub-account of a settlement bank (SB B) of AS2.
Functional controls	2	If procedure 6 is open in AS1 and AS2, then the order is transmitted to PM, else the order is rejected.
Settlement	3	The liquidity is transferred from technical account - procedure 6 real-time of AS1 to SB B's sub-account with AS2.
Notification	4	The notification on settlement is transmitted to ASI.
	5	AS1 or its CB is notified (ASInitiationStatus) on the outcome of the cross-AS settlement request. If the cross-AS settlement is sent by the CB on behalf of AS1, then AS1 is notified on successful settlement with a ReturnAccount message. AS2 is notified on the increase of liquidity in the sub-account with a specific ASTransferNotice for Cross AS including the resulting balance.
	6	On an optional basis, the settlement bank of the AS2 is notified in case of successful settlement via MT 910. This notification is not available for Internet-based settlement banks.

Cross-AS settlement from Real-time AS to Real-time AS

Cross-AS is a single payment sent with an ASTransferInitiation by an AS (AS1 or its CB on behalf) to debit the technical account - procedure 6 real-time on behalf of a settlement bank in order to credit the technical account - procedure 6 real-time of another AS (AS2) on behalf of a settlement bank. The reverse transaction is not allowed. Although this feature is rather intended for overnight business it is also available in daylight procedure.

AS2 receives a notification (ASTransferNotice) on the incoming liquidity to the technical account - procedure 6 real-time including the information of the resulting balance. AS2 has the possibility to use immediately this credit.

2 User Guide for Payments Module (PM)

- 2.8 Settlement of ancillary systems
- 2.8.3 Work flow of “dedicated liquidity” settlement procedure

A bilateral agreement between AS1 and AS2 is a precondition to use Cross-AS settlement. This agreement has to be input in SD by the relevant CBs.

The Cross-AS transaction can be sent during an open procedure of AS1 and AS2. The settlement is executed immediately regardless of the cycle status of AS1 and AS2.

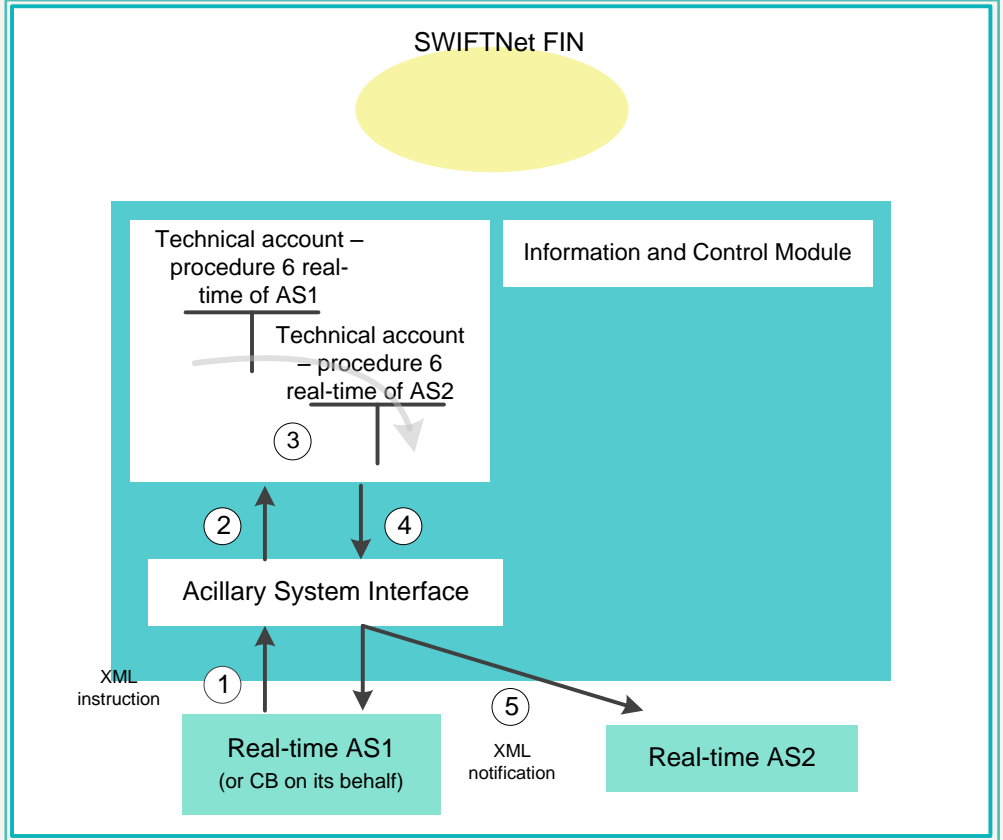

2 User Guide for Payments Module (PM)

2.8 Settlement of ancillary systems

2.8.3 Work flow of “dedicated liquidity” settlement procedure

Phase	Step	Description
Initiation	1	Request of Cross-AS settlement AS1 (or its CB on its behalf) sends an XML message (ASTransferInitiation) with a single payment to transfer liquidity from the technical account - procedure 6 real-time of AS1 on behalf of SB A to the technical account - procedure 6 real-time of AS2 on behalf of SB B.
Functional controls	2	If procedure 6 is open in AS1 and AS2, then the order is transmitted to PM, else the order is rejected.
Settlement	3	The liquidity is transferred from technical account - procedure 6 real-time of AS1 to the technical account - procedure 6 real-time of AS2.
Notification	4	The notification on settlement is transmitted to ASI.
	5	AS1 or its CB is notified (ASInitiationStatus) on the outcome of the cross-AS settlement request. If the cross-AS settlement is sent by the CB on behalf of AS1, then AS1 is notified on successful settlement with a ReturnAccount message. AS2 is notified on the increase of liquidity in the technical account - procedure 6 real-time with a specific ASTransferNotice for Cross AS including the resulting balance.

End of procedure and liquidity back transfer

An end of procedure message is needed only in case a start of procedure message will be sent to execute standing orders for daylight procedure. The requestor (AS or CB) will be notified of the execution of the order to close the procedure (ReturnGeneralBusinessInformation).

At the end of the night-time cycle ASs working on real-time basis and willing to return back possible remaining liquidity to their participants have to perform a liquidity transfer from the technical account - procedure 6 real-time to the RTGS participants' accounts following the standard rules already described.

There is no obligation for ASs working on real-time basis to return funds at the end of night or end of day processing.

2 User Guide for Payments Module (PM)

2.8 Settlement of ancillary systems

2.8.3 Work flow of “dedicated liquidity” settlement procedure

2.8.3.2.2 Night-time business: interfaced model

The settlement procedure on dedicated account when applied to AS based on interfaced model implies that the liquidity transfer from the RTGS participant’s account is directed to its dedicated sub-accounts held in the PM.

The standing orders can be posted by the settlement banks (via ICM).

Settlement banks, via ICM, can

- place a standing order (a specific standing order for the night-time procedure envisaged).
- insert or modify the amount of dedicated liquidity using current orders (once the start of procedure message has been sent).

Setting of standing order, liquidity adjustment and start of cycle

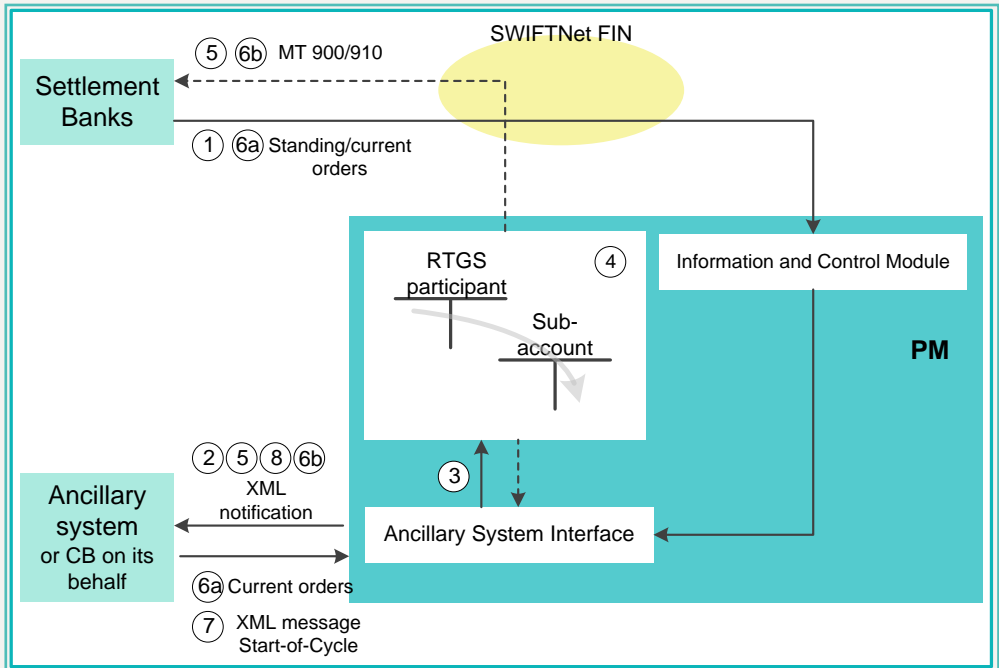

2 User Guide for Payments Module (PM)

2.8 Settlement of ancillary systems

2.8.3 Work flow of “dedicated liquidity” settlement procedure

Phase	Step	Description
Setting of standing orders	1	During the business day it is possible for a settlement bank to determine the liquidity input for the forthcoming night-time business. A settlement bank can set several standing orders (ModifyStandingOrder to store the amount in the Static Data module) for a specific AS against its RTGS account (eg to separate own business and third-party business). Changes of standing orders in ICM will always become effective in the next night-time procedure.
Start of procedure	2	Start of procedure message is automatically initiated by ASI after re-opening of new business day. The AS will be notified on the event (ReturnGeneralBusinessInformation).
Standing orders execution	3	The start of procedure message triggers the execution of existing standing orders debiting settlement bank's RTGS account and crediting the pertaining sub-account.
	4	The liquidity transfer takes place. If the total sum of all standing orders of a settlement bank is larger than the liquidity on its RTGS account (cash & credit line), all standing orders will be reduced in a pro-rata mode, ie the existing liquidity is divided by the total sum of standing orders and the resulting factor will be used to reduce each standing order of this participant.
	5	On an optional basis the settlement banks receive the debit notification on the RTGS accounts (MT 900) and the credit notification on the sub-accounts (MT 910). The notifications (MT 900/MT 910) are not available for Internet-based settlement banks. XML notification (ReturnAccount) on credit of the sub-account is sent to the AS for the amounts actually booked.
Liquidity adjustment	6a	In addition current orders that are stored in the AS can be sent by the AS (ASTransferInitiation) via ASI (the AS cannot set standing orders on behalf of its settlement bank, to provide such a functionality the AS has to store and manage in its own procedure outside the SSP any potential standing orders and send them at the appropriate time as current orders).

2 User Guide for Payments Module (PM)

2.8 Settlement of ancillary systems

2.8.3 Work flow of “dedicated liquidity” settlement procedure

Phase	Step	Description
		Settlement banks can also instruct current orders via ICM either in A2A with XML LiquidityCreditTransfer or in U2A with the screen LiquidityTransfer to sub-account. In A2A, the settlement bank receives a technical receipt.
	6b	<p>Current orders will be</p> <ul style="list-style-type: none">• immediately executed.• notified to the settlement bank (not to the Internet-based settlement bank) (MT 900/910) (optional).• Notified to the AS:<ul style="list-style-type: none">– with XML ReturnAccount when the settlement bank has issued the current order.– with XML ASInitiationStatus when the AS has issued the current order. <p>If the liquidity on the RTGS account or on the sub-account is insufficient to cover the current order, it is:</p> <ul style="list-style-type: none">• partially executed (ie up to the available liquidity on the RTGS account or on the sub-account concerned) if it was sent by the AS. If several orders were sent simultaneously for the same settlement bank, they are executed in the same order as in the AS message up to the available liquidity, and the last order that is not rejected is partially executed. In case there is no liquidity available at all, the amount is reported as zero (0) euro.• rejected if it was sent by the settlement bank. <p>In case a highly urgent payment is pending in queue and has been submitted earlier than the current order, the current order will be rejected.</p>

2 User Guide for Payments Module (PM)

2.8 Settlement of ancillary systems

2.8.3 Work flow of “dedicated liquidity” settlement procedure

Phase	Step	Description
Start of cycle	7	Once the start of cycle message has been sent the incoming current orders will be stored till the end of cycle and immediately executed just after that.
Blocking of funds	8	Funds on sub-accounts are blocked, the AS is notified on the amount actually blocked (ASReturnAccount). The set-aside liquidity cannot be increased/decreased any longer during the cycle by settlement bank or AS out of the provided automatic functionality (see below).

Automatic increase of blocked liquidity by auto-collateralisation

This section presents how the SSP will technically support the present features of auto-collateralisation which are offered by certain NCBs.

Auto-collateralisation is a special feature pertaining the ASs acting as an SSS only and stemming from their double role of user and liquidity provider. The form in which the collateral is provided, firm collateralisation, based on stock, or self collateralisation, based on flows, is important only as far as relations between the settlement bank and the AS are concerned. As regards to dedicated liquidity adjustment in the SSP the two models do not bring any differences.

2 User Guide for Payments Module (PM)

2.8 Settlement of ancillary systems

2.8.3 Work flow of “dedicated liquidity” settlement procedure

The auto-collateralisation processing includes - at least - four major steps in a triangle of relations among SSS, CB and the SSP:

Step	Description
1	The SSS enters securities transfers (additional) from the security account of an AS participant to the security collateral account of the CB.
2	The collateral is evaluated and the related liquidity taken into consideration by the SSS during settlement procedure in favour of the AS participant.
3	SSS notifies collateral transfers to CB to allow the collateral management system alignment.
4	The settlement bank liquidity position in PM must be adjusted before the settlement to take into account the liquidity made available by the previous steps.

Only step 4 is in the SSP perimeter, therefore in the following only this step will be considered.

The way of using collateral (pledge versus repo) varies across Europe from country to country. The SSP has consequently to offer several procedures to allow the liquidity adjustment and to reach a certain degree of standardisation.

The operations of auto-collateralisation (increase or decrease) are rejected if they are received outside of open cycles.

2 User Guide for Payments Module (PM)

2.8 Settlement of ancillary systems

2.8.3 Work flow of “dedicated liquidity” settlement procedure

Option I: repo countries

To increase liquidity on SSS cash account (debit CB’s RTGS account, credit sub-account of AS participant), the CB (or the AS on its behalf) has to send a specific message (ASTransferInitiation).

Option II: pledge countries

Three sub-options depending on the degree of outsourcing of the collateral management functions:

Sub-option	Explanation
a)	Connected payment entered by the relevant CB (where the incoming increase of settlement bank credit line automatically forward a liquidity transfer to the settlement bank’s sub-account) acting as collateral management.
b)	Connected payment entered by the AS.
c)	Mandated payment against a specific auto-collateral RTGS account for each settlement bank/AS (debit auto-collateral account, credit RTGS sub-account). The liquidity must be returned during the day by the settlement banks to reset to zero the auto-collateral account balance.

2 User Guide for Payments Module (PM)

- 2.8 Settlement of ancillary systems
- 2.8.3 Work flow of “dedicated liquidity” settlement procedure

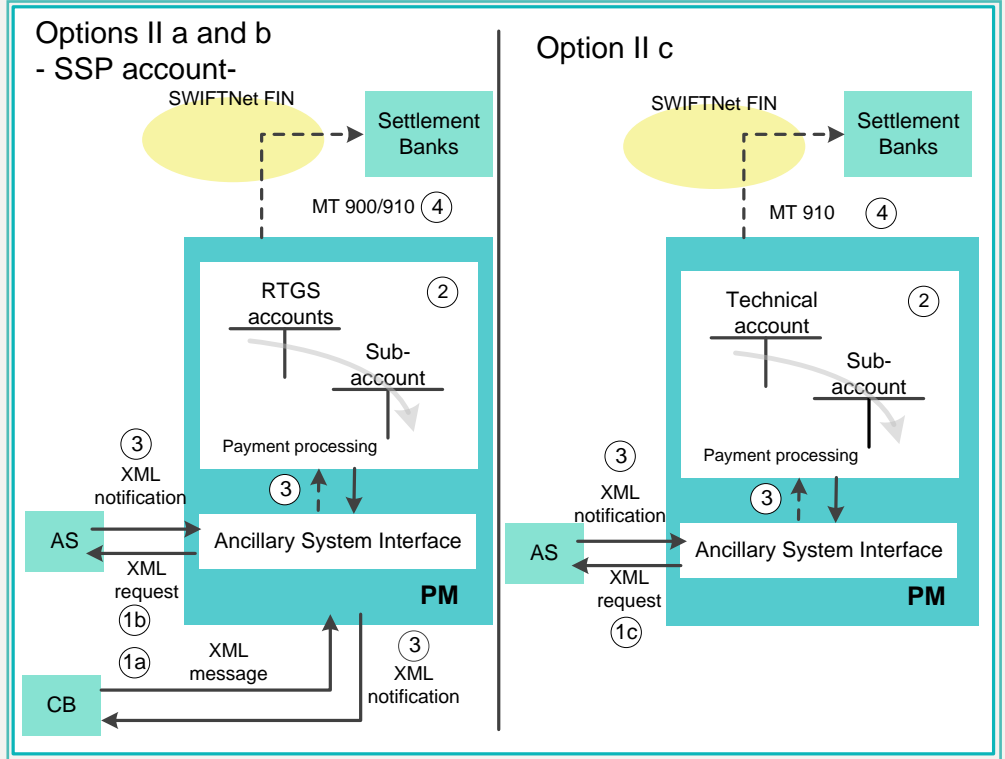

2 User Guide for Payments Module (PM)

2.8 Settlement of ancillary systems

2.8.3 Work flow of “dedicated liquidity” settlement procedure

Phase	Step	Description
Initiation	1	<p>The CB (option a) or the AS (options b and c) requests for an increase of the dedicated liquidity due to auto-collateralisation:</p> <ul style="list-style-type: none"> • Option a: The CB, once it has completed the internal operations, sends an XML message (ASTransferInitiation, for the format see chapter 9.2.6 Use cases for AS, page 572) to increase the credit line in the main settlement bank’s RTGS account and, in the same time, to debit it in favour of the sub-account (see step 2a/2b). • Option b: The AS, once it has completed the internal operations, sends a message (ASTransferInitiation, for the format see chapter 9.2.6 Use cases for AS, page 572) to increase the credit line in the main settlement bank’s RTGS account and, in the same time, to debit it in favour of the sub-account (see step 2a/2b). • Option c: The AS, once it has completed the internal operations, sends a file (ASTransferInitiation) to initiate a set of mandated payments debiting a specific auto-collateral account against the settlement bank dedicated sub-accounts.
Liquidity transfer and blocking	2a/2b	PM initiates a payment to transfer liquidity from the settlement bank’s main RTGS account to the dedicated sub-account.
	2c	PM executes the mandated payments of above.
	3	<p>The AS receives the XML notification (ReturnAccount in case IIa, ASInitiationStatus in case IIb and IIc) on the increase of the liquidity in the sub-account via ASI (for the format see chapter 9.2.6 Use cases for AS, page 572).</p> <p>In case IIa the CB receives an XML notification (ASInitiationStatus).</p>
	4	Option II a and b: On an optional basis, the settlement banks are

2 User Guide for Payments Module (PM)

2.8 Settlement of ancillary systems

2.8.3 Work flow of “dedicated liquidity” settlement procedure

Phase	Step	Description
		<p>notified on the increase of liquidity on the sub-account (MT 910) and on the decrease of liquidity on the main RTGS account (MT 900). The notifications (MT 900/MT 910) are not available for Internet-based settlement banks.</p> <p>Option II c: On an optional basis, the settlement banks are notified on the increase of liquidity on the sub-account (MT 910). The notification is not available for Internet-based settlement banks.</p>

Options II a and II b may also have an alternative when credit lines are managed out of the SSP in the proprietary home accounting system.

2 User Guide for Payments Module (PM)

- 2.8 Settlement of ancillary systems
- 2.8.3 Work flow of “dedicated liquidity” settlement procedure

In this case the CB (or the AS on its behalf) wishing to transfer liquidity from CB main RTGS account directly to the respective sub-account in order to increase the liquidity on the “settlement account” vis-à-vis a credit line internally managed has to send an ASTransferInitiation message.

Options II a and b
- proprietary home account -

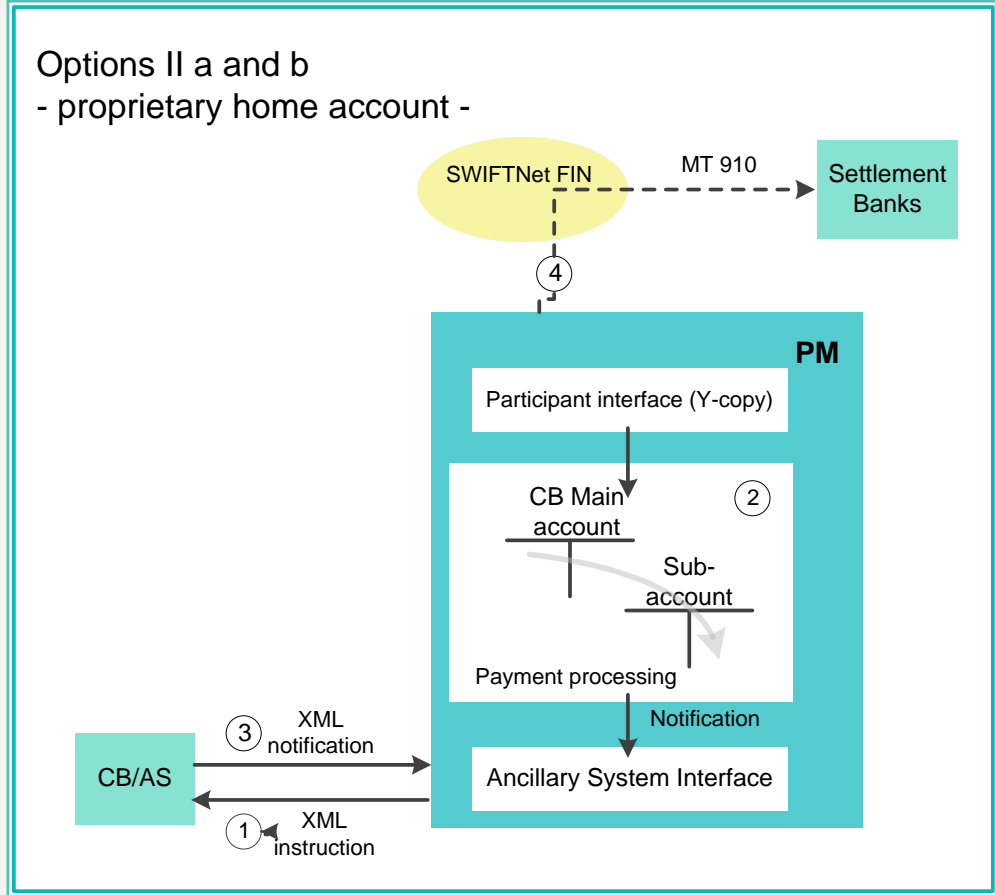

2 User Guide for Payments Module (PM)

2.8 Settlement of ancillary systems

2.8.3 Work flow of “dedicated liquidity” settlement procedure

Phase	Step	Description
Initiation	1	The CB (option a) or the AS (option b) sends an XML message (ASTransferInitiation) to transfer liquidity from the CB RTGS main account to the settlement bank’s sub-account.
Liquidity transfer and blocking	2	The settlement process takes place with the debit and the credit of the pertinent accounts.
	3	The AS receives the XML notification (ReturnAccount in case a, ASInitiationStatus in case b) on the increase of the liquidity in the sub-account via ASI (for the format see chapter 9.2.6 Use cases for AS, page 572).
	4	Settlement banks are notified on an optional basis on the increase of liquidity on the sub-account (MT 910). The notification is not available for Internet-based settlement banks.

Decrease of blocked liquidity by auto-collateralisation

A decrease of the dedicated liquidity originated by auto-collateralisation is also foreseen but only as a specific CB function performed on an exceptional basis (eg reverse transaction in case of errors) normally related to a pre-definite contingency measure vis-à-vis the AS.

Automatic increase of blocked liquidity by specific transactions

The increase of the dedicated liquidity amount can also be triggered by the AS through specific transactions (ie coupons and redemption) to be credited to the settlement banks’ accounts. This facility is provided to further increase the dedicated liquidity before the start of the settlement process.

2 User Guide for Payments Module (PM)

2.8 Settlement of ancillary systems

2.8.3 Work flow of “dedicated liquidity” settlement procedure

To make it possible to increase the liquidity on the settlement bank’s sub-account, a technical AS account has to be firstly provided of the needed liquidity before the starting of the settlement phase.

As regards the operations of auto-collateralisation, the specific transactions are rejected if they are received outside an open cycle.

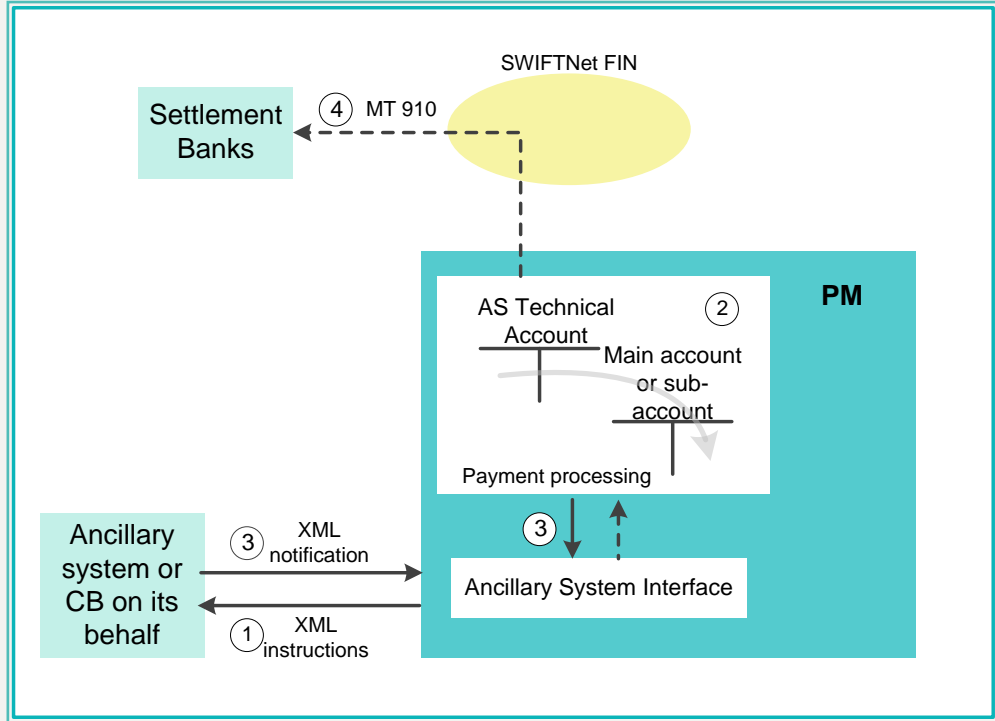

2 User Guide for Payments Module (PM)

2.8 Settlement of ancillary systems

2.8.3 Work flow of “dedicated liquidity” settlement procedure

Phase	Step	Description
Initiation	1	The AS sends a set of credit transfers to ASI (ASTransferInitiation). Within the file, for each transaction, it will be possible to indicate (as account to be credited) either the settlement bank’s sub-account or the settlement bank’s RTGS account.
Liquidity transfer and blocking	2	The pertinent settlement bank’s RTGS accounts (either main or sub-account) are credited against the AS technical account.
	3	The AS receives via ASI the XML notification (ASInitiationStatus) of the increase of the liquidity on settlement banks’ main or sub-accounts (for the format see chapter 9.2.6 Use cases for AS, page 572).
	4	The settlement banks receive the credit notification (MT 910) on an optional basis. The notification is not available for Internet-based settlement banks.

2 User Guide for Payments Module (PM)

2.8 Settlement of ancillary systems

2.8.3 Work flow of “dedicated liquidity” settlement procedure

Settlement

The settlement based on dedicated liquidity is illustrated in the following diagram:

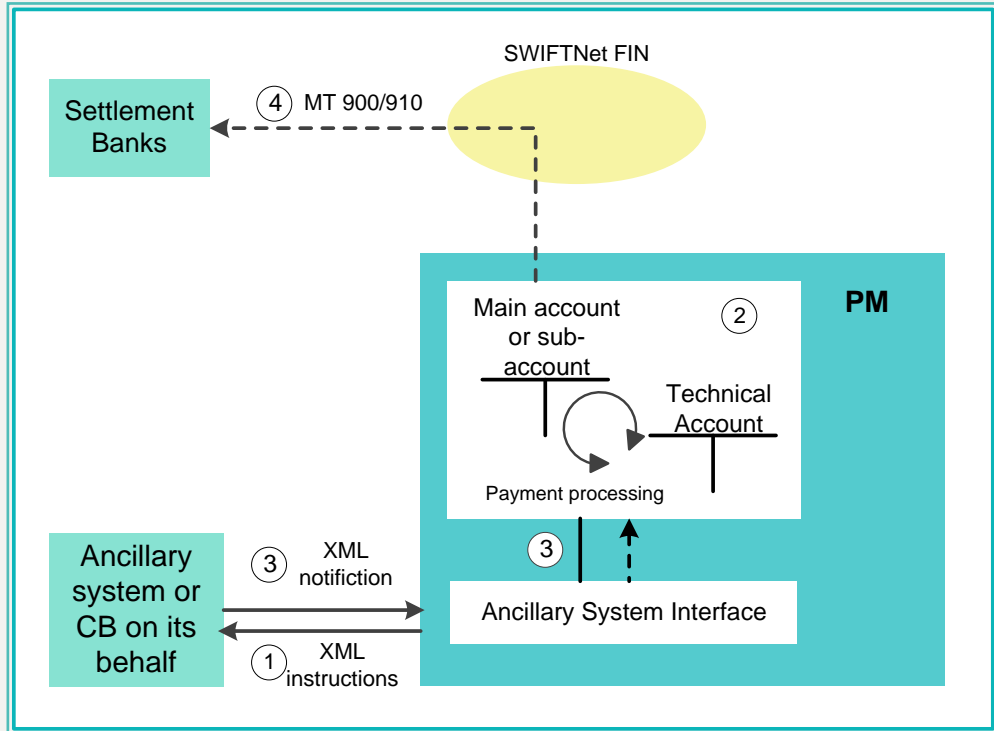

2.8 Settlement of ancillary systems

2.8.3 Work flow of “dedicated liquidity” settlement procedure

Phase	Step	Description
Initiation	1	The AS sends instructions to PM via FileAct (ASTransferInitiation).
Settlement	2	<p>The settlement process takes place: debiting the participants’ sub-accounts towards the AS technical account and then debiting the AS technical account towards the participants’ sub-accounts. In case of credit balances the booking can take place directly - if indicated by the AS within the pertinent transaction - on the settlement bank’s RTGS account.</p> <p>If the settlement of one (or more) debit payments is unsuccessful (it may happen only in case of an AS’s error), the related payment is queued on the sub-account. At the end of the cycle all transactions debiting the same sub-account with insufficient liquidity for their settlement are rejected even if only one transaction cannot be settled.</p> <p>The settlement can avail itself of the optimisation process (algorithm 5 running on sub-accounts). (See chapter 2.7.3 Dissolution of payment queue, page 155.)</p>
Notification	3	<p>After the end of the settlement the AS will receive one file as confirmation. The file will contain a list of the credits and debits settled (ASInitiationStatus).</p> <p>If some transactions are not settled until the end of cycle, the ASIInitiationStatus will be sent at the end of the cycle with the individual status of each transaction.</p>
	4	On an optional basis, the settlement banks receive the debit notification (MT 900) or the credit notification (MT 910) related to the settlement on dedicated sub-accounts. The notifications (MT 900/ MT 910) are not available for Internet-based settlement banks.

2.8 Settlement of ancillary systems

2.8.3 Work flow of “dedicated liquidity” settlement procedure

Cross-AS settlement between Interfaced AS

Cross-AS is a single payment sent with an ASTransferInitiation by an AS (AS1 or its CB on behalf) to debit the sub-account of one of its participants in order to credit the sub-account of one of the participants of an other AS (AS2). The reverse transaction is not allowed. Although this feature is rather intended for overnight business it is also available in daylight procedure.

AS2 receives a notification (ASTransferNotice) on the incoming liquidity to the sub-account including the information of the resulting balance. AS2 has the possibility to use immediately this credit.

A bilateral agreement between AS1 and AS2 is a precondition to use Cross-AS settlement. This agreement has to be input in SD by the relevant CBs.

The cross-AS transaction has to be sent during an open cycle of AS1, the procedure 6 of AS2 must be opened. The settlement is executed immediately whatever is the status of the cycle of AS2.

2 User Guide for Payments Module (PM)

- 2.8 Settlement of ancillary systems
- 2.8.3 Work flow of “dedicated liquidity” settlement procedure

The transaction is rejected if the liquidity in the sub-account is insufficient.

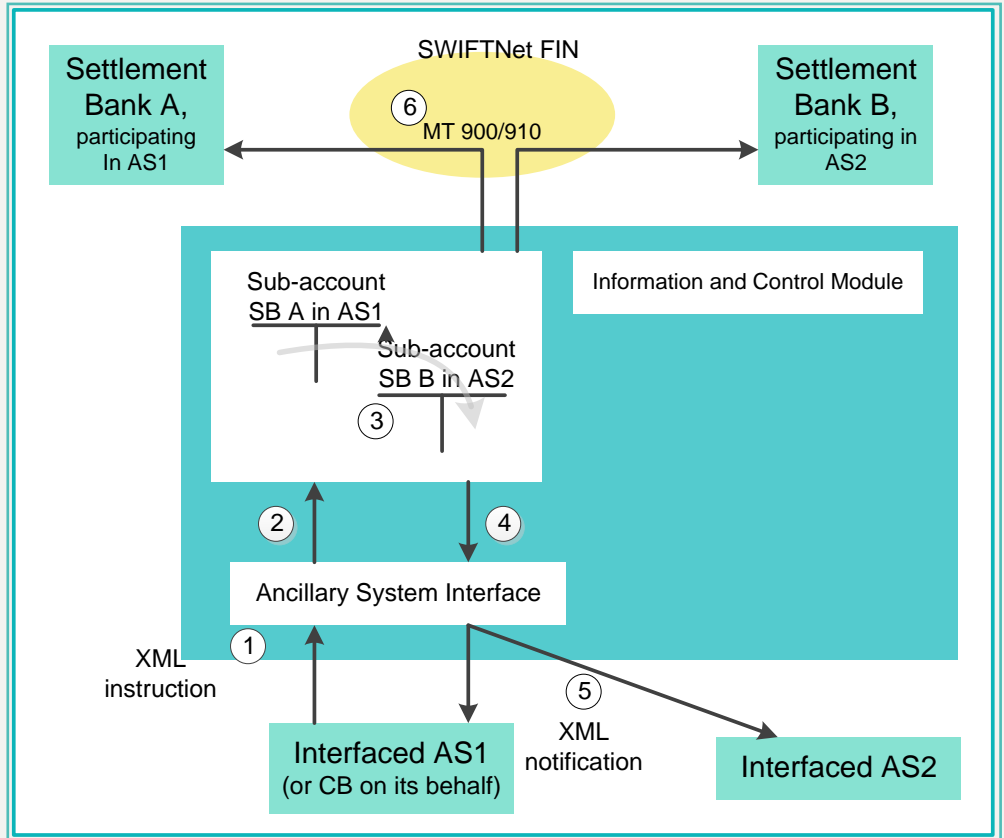

2 User Guide for Payments Module (PM)

2.8 Settlement of ancillary systems

2.8.3 Work flow of “dedicated liquidity” settlement procedure

Phase	Step	Description
Initiation	1	Request of Cross-system AS settlement AS1 (or its CB on its behalf) sends an XML message (ASTransferInitiation) with a single payment to transfer liquidity from the sub-account of one of its settlement banks (SB A) to the sub-account of a settlement bank (SB B) of AS2.
Functional controls	2	If procedure 6 is open in AS1 and AS2 and if the cycle is open in AS1, then the order is transmitted to PM, else the order is rejected.
Settlement	3	If the liquidity on SB A's account is sufficient, the liquidity is immediately transferred from SB A's sub-account with AS 1 to SB B's sub-account with AS 2. Otherwise the request of Cross-AS settlement is rejected.
Notification	4	The notification on settlement is transmitted to ASI.
	5	AS1 or its CB is notified (ASInitiationStatus) on the outcome of the cross-AS settlement request. If the cross-AS settlement is sent by the CB on behalf of AS1, then AS1 is notified on successful settlement with a ReturnAccount message. AS2 is notified on the increase of liquidity in the sub-account with a specific ASTransferNotice for Cross AS including the resulting balance.
	6	On an optional basis, the settlement banks of the AS participants are notified in case of successful settlement via MT 900/910. The notifications (MT 900/MT 910) are not available for Internet-based settlement banks.

Cross-AS settlement from Interfaced AS to Real-time AS

Cross-AS is a single payment sent with an ASTransferInitiation by an AS (AS1 or its CB on behalf) to debit the sub-account of one of its participants in order to credit the technical account - procedure 6 real-time of an other AS (AS2) on behalf of a settlement bank. The reverse transaction is not allowed. Although this feature is rather intended for overnight business it is also available in daylight procedure.

2 User Guide for Payments Module (PM)

2.8 Settlement of ancillary systems

2.8.3 Work flow of “dedicated liquidity” settlement procedure

AS2 receives a notification (ASTransferNotice) on the incoming liquidity to the technical account - procedure 6 real-time including the information of the resulting balance. AS2 has the possibility to use immediately this credit.

In Static Data there must be a bilateral agreement between both AS (AS1 and AS2).

The cross-AS transaction has to be sent during an open cycle of AS1, the procedure 6 of AS2 must be opened. The settlement is executed immediately whatever is the status of the cycle of AS2.

2 User Guide for Payments Module (PM)

- 2.8 Settlement of ancillary systems
- 2.8.3 Work flow of “dedicated liquidity” settlement procedure

The transaction is rejected if the liquidity in the sub-account is insufficient.

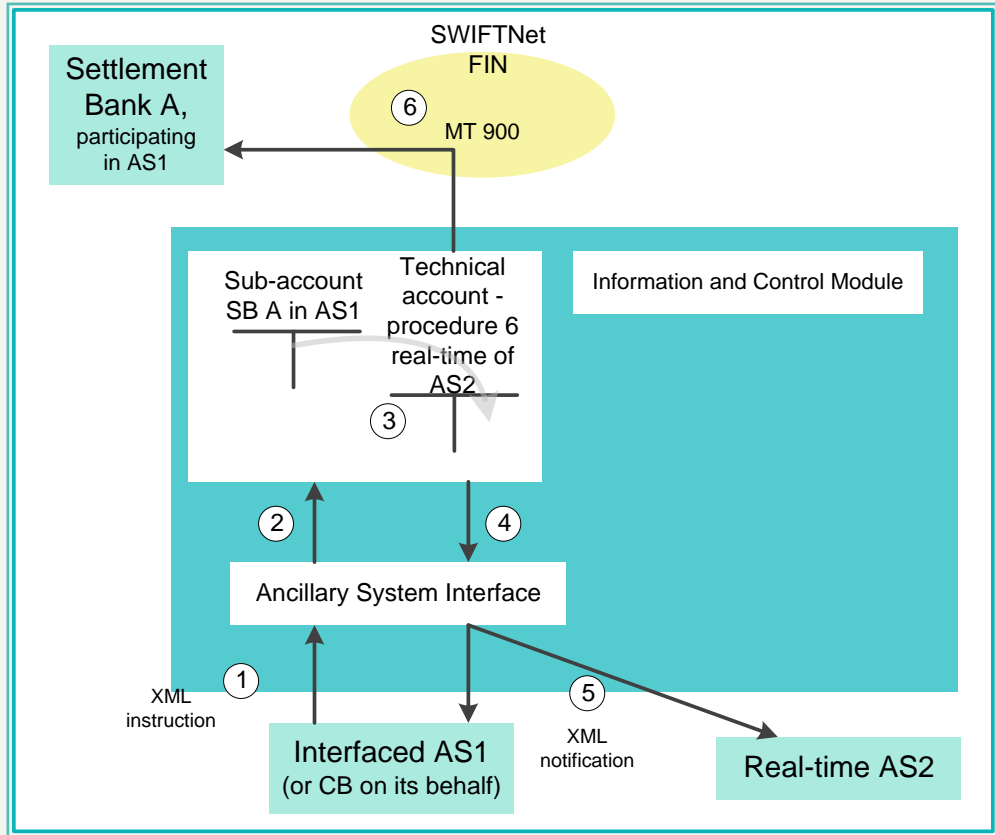

2 User Guide for Payments Module (PM)

2.8 Settlement of ancillary systems

2.8.3 Work flow of “dedicated liquidity” settlement procedure

Phase	Step	Description
Initiation	1	Request of Cross-AS settlement AS1 (or its CB on its behalf) sends an XML message (ASTransferInitiation) with a single payment to transfer liquidity from the sub-account of one of its settlement banks (SB A) to the technical account - procedure 6 real-time of AS2 on behalf of SB B.
Functional controls	2	If procedure 6 is open in AS1 and AS2 and if the cycle is open in AS1, then the order is transmitted to PM, else the order is rejected.
Settlement	3	If the liquidity on SB A's account is sufficient, the liquidity is immediately transferred from SB A's sub-account with AS 1 to the technical account - procedure 6 real-time of AS 2 on behalf of SB B. Otherwise the request of Cross-AS settlement is rejected.
Notification	4	The notification on settlement is transmitted to ASI.
	5	AS1 or its CB is notified (ASInitiationStatus) on the outcome of the cross-AS settlement request. If the Cross-AS settlement is sent by the CB on behalf of AS1, then AS1 is notified on successful settlement with a ReturnAccount message. AS2 is notified on the increase of liquidity in the technical account - procedure 6 real-time with a specific ASTransferNotice for Cross-AS including the resulting balance.
	6	On an optional basis, the settlement bank of AS1 is notified in case of successful settlement via MT 900. The notification is not available for Internet-based settlement banks.

End of cycle and end of procedure

Phase	Step	Description
End of cycle	1	AS (or CB on behalf) sends an XML “end of cycle” message via ASI (ReturnGeneralBusinessInformation, for the format see chapter 9.2.6 Use cases for AS, page 572) or requests the end of cycle through the ICM.
Liquidity	2	The ASI releases the remaining liquidity and notifies the AS

2 User Guide for Payments Module (PM)

2.8 Settlement of ancillary systems

2.8.3 Work flow of “dedicated liquidity” settlement procedure

Phase	Step	Description
release		through ReturnGeneralBusinessInformation. Possible current orders received during the cycle that have been stored till the end of cycle are immediately executed just after that. Settlement transactions and current orders issued by the AS aiming to debiting the sub-account and crediting the participant's RTGS account are also possible to allow the reallocation of the liquidity in favour of other settling ASs. A new cycle can be possibly triggered by the AS. Current orders received between two cycles are immediately executed.
End of procedure	3	AS (or CB on behalf) can send an XML “end of procedure” message via ASI (ReturnGeneralBusinessInformation, for the format see chapter 9.2.6 Use cases for AS, page 572) or requests the end of procedure through the ICM.
Back transfer of liquidity	4	If “end of procedure” message has been sent the remaining liquidity on sub-accounts is transferred back to the main settlement bank's RTGS accounts.
	5	The requestor (AS or CB) is notified via ASI (ReturnAccount for the format see chapter 9.2.6 Use cases for AS, page 572).
	6	On an optional basis, the settlement banks receive the debit notification on the dedicated sub-accounts (MT 900) and the credit notification on the main RTGS accounts (MT 910). The notifications (MT 900/MT 910) are not available for Internet-based settlement banks.

Note: If needs be, the AS can omit to send the end of procedure message related to the night-time procedure. In this case, when the SSP enters into daylight phase and an AS night-time procedure is still open:

- The liquidity is kept on the sub-accounts (interfaced model).

2.8 Settlement of ancillary systems

2.8.3 Work flow of “dedicated liquidity” settlement procedure

- The ASs cannot send a start of procedure message related to the day-light business (and, consequently, not execute standing orders for day-light procedure) before ending its night-time procedure.
- The ASI will keep on behaving like in night-time phase towards the respective AS, although the SSP is in daylight phase, until the AS closes its night-time procedure.

2.8.3.3 Daylight business

As already stated the settlement on dedicated liquidity accounts is suitable both for night-time batch and daylight settlement procedures. Some differences have to be in any case considered.

During daylight business, settlement with dedicated liquidity will mainly be used for AS operating with interfaced settlement.

Daylight current orders to the technical account - procedure 6 real-time can be set up for AS operating with real-time settlement. Additionally, it is possible to transfer liquidity to the technical account - procedure 6 real-time using MT 202.

Note: Although still present in TARGET2, procedure 1 should not be used anymore since it is limited to daylight processing only. For details please refer to the Guideline on TARGET2 and its amendments (<https://www.ecb.europa.eu/ecb/legal/1003/1349/html/index.en.html>).

Interfaced AS benefits from a similar range of functionality in daylight and in night-time business, but with somewhat different business rules. The differences between night-time and daylight business are highlighted below.

During the business day it is possible for a settlement bank to determine the liquidity input for the next forthcoming days. A settlement bank can set several standing orders for several specific ASs against its RTGS account (eg to separate own business and third-party business). Changes of standing orders in ICM will always become effective for the next business day.

A start of procedure message can be entered by the AS (or the CB on behalf) by using ReturnGeneralBusinessInformation. The daylight procedure

Setting of standing orders

2 User Guide for Payments Module (PM)

2.8 Settlement of ancillary systems

2.8.3 Work flow of “dedicated liquidity” settlement procedure

Start of procedure

can be opened during the night-time phase but if a night-time procedure was used, it is a pre-requisite that an end of procedure message for night-time procedure is sent.

Standing order execution

Once the start of procedure has been launched and until the start of cycle occurs existing standing orders are taken into account. If several ASs have launched their procedures the standing orders are executed in the same order as of the incoming start of procedure messages from the different ASs (FIFO principle).

The settlement bank’s RTGS account is therefore debited and the sub-account (interfaced) credited.

The debit of the RTGS account is notified with an MT 900 to the settlement bank (optional). This notification is not available for Internet-based settlement banks.

On an optional basis an MT 910 is sent to the settlement bank, if the settlement bank is not an Internet-based settlement bank, for crediting its sub-account (interfaced). The ASI confirms the start of procedure with the result of the execution of the standing orders in the ReturnAccount for interfaced models.

If a standing order is not covered, it will be rejected; the settlement bank can initiate, if really needed, a current order in the following liquidity adjustment phase (see below).

In case there are several standing orders, ie if the settlement bank has standing orders to credit several of its sub-accounts related to the interfaced AS, then the standing orders will be executed in decreasing order of their amount.

Liquidity adjustment

Before start of cycle message is sent further liquidity adjustments (current orders or payments) can be initiated.

Standing orders (increases) that are deposited in the AS can be sent by the AS via ASI as current orders.

2 User Guide for Payments Module (PM)

2.8 Settlement of ancillary systems

2.8.3 Work flow of “dedicated liquidity” settlement procedure

Liquidity increases will be notified to the settlement bank (MT 900/910) (optional), if the settlement bank is not an Internet-based settlement bank, and to the AS (ASReturnAccount).

Liquidity decreases (transfer of liquidity to main account) are only possible for the interfaced model, but only using a current order via the ICM (LiquidityCreditTransfer).

If the liquidity on the RTGS account is insufficient to cover the current order sent by the AS, the order is partially executed (ie up to the available liquidity on the RTGS account concerned).

In case a highly urgent payment is pending in queue and has been submitted earlier than the current order, the current order will be rejected.

Start of cycle

The end of the previous adjustment phase occurs when the AS (or the CB on its behalf) enters a start of cycle message. Once the message has been received the ASI initiates the following step blocking the funds. Incoming current orders will be stored till the next liquidity adjustment period: they will be executed immediately after the end of cycle. Incoming liquidity transfers via payments will be executed immediately but the AS is not notified.

The opening of a cycle in a procedure 6 real-time is no longer necessary.

Blocking of funds

The cycle starts blocking the set aside liquidity.

The liquidity available on the sub-account consists of:

- the balance on the sub-account (either left after a previous cycle or coming from the execution of the standing orders in case of first cycle with the procedure), plus
- liquidity coming from the execution of the current orders stored during the previous cycle.

Funds on sub-accounts are blocked and cannot be decreased any longer by the settlement bank. The blocked amount is notified to AS via ASI. Increasing the funds is still possible by payments (MT 202), this functionality is not available for Internet-based settlement bank. The increasing amount will be

End of cycle and release of liquidity

notified to the AS via ASI, during the cycle if the AS has opted for this functionality.

As far as auto-collateralisation, automatic increase of the dedicated liquidity and settlement phases are concerned details regarding flows and messages are the same of the night-time cycle.

The cross-AS settlement is also allowed during the daylight procedure 6.

An end of cycle message sent by the AS (or the CB on its behalf) declares the end of the current cycle. The ASI will notify the AS only on the release (ie unblocking) of liquidity (ReturnGeneralBusinessInformation).

If other cycles are foreseen a new liquidity adjustment phase starts: immediately after end of cycle message has been received by ASI, the execution of stored current orders takes place; new current orders and payments to set aside the liquidity would be taken newly into account.

Reverse transactions in order to fine-tune the set aside liquidity are allowed but only as a current order (ASTransferInitiation) and only for the interfaced model.

The AS can at this stage send a new start of cycle message to initiate a new cycle with the already described steps.

If other cycles are not envisaged the AS will send immediately after the end of cycle an end of procedure message.

End of procedure and back transfer of liquidity

An end of procedure message has to be entered by the AS when all balances have been settled and the residual liquidity should be returned to RTGS main account. As far as each single step is concerned details regarding flows and messages are the same of the night-time cycle.

2.8.4 Contingency measures

Contingency measures for ancillary systems using the ASI can be needed in case of unavailability of:

1. the SSP as a whole
2. an ancillary system or its communication infrastructure with SSP

3. regional SWIFT outage

In the first scenario - unavailability of the whole SSP - the only tool available is the Enhanced Contingency Solution (ECONS I). This module can be used for a number of consecutive days (up to 5) with the possibility of closing the business day and processing critical and very critical payments. It is at the discretion of the CBs to determine which payments will be processed in the ECONS I; a CB is able to agree/disagree (via U2A) the processing of each payment inserted by the participant. ECONS I only supports "straight forward payment processing" (no queuing mechanism is in place). ECONS I supports processing of AS files (kind of settlement procedure 4) uploaded by CBs on behalf of the Ancillary System in A2A mode (no agree/disagree functionality needed in this case).

In the second scenario specific contingency measures have to be foreseen by the AS itself. Yet in case the AS can provide payment instructions the relevant CB can execute these payments on behalf of the AS.

This paragraph refers to these specific contingency situations.

In these cases a specific tool will be available for the CB to enter the relevant instructions in the SSP.

In addition it is assumed that the AS has concluded its internal cycles. For communication problem or AS unavailability:

- Information has to be provided by the AS to the CB by an alternative mean (for example by secure fax, file sent by email or secure internet connection etc.) bilaterally agreed.
- The CB acting on behalf of the AS has to enter the received payment instructions in the SSP.

To be able to support the settlement of ancillary systems the following functionalities will be offered to the CBs:

- debiting of the accounts of a settlement bank against the crediting of another settlement bank

- debiting the AS technical account in return of a settlement bank's account
- carrying out liquidity transfers from the "main" to a sub-account of a settlement bank or technical account - procedure 6 real-time, and vice versa
- modifying the credit lines (for auto-collateralisation) of a settlement bank
- ending or starting a cycle for an AS
- ending or starting a procedure for an AS

Special consideration should be given to multi-country AS. In case an AS has settlement banks in several countries the processing of the contingency payments can be executed by the CB of the AS. No problem with authorisations is foreseen as a direct debit agreement between the AS and the settlement bank will be the basis. Alternatively co-ordination between the two relevant CBs (for the AS and the settlement bank) can be envisaged in the form of a specific contingency arrangement. In case one AS operates more than one SSS contingency, arrangements should be made per SSS and possibly with different CBs.

It has eventually to be added that the use of such a contingency measures for the night-time settlement on dedicated liquidity will be settled by a specific service level agreement.

In the third scenario: case of regional SWIFT outage.

In network contingency mode only NCBs and the SSP OT have access to the PAPSS via the Eurosystem's CoreNet contingency network. Participants, credit institutions and ancillary systems, unable to access the PAPSS, have to transmit via contingency means agreed at national level, their instructions to their central bank.

The fact that a contingency mode is activated for a CB does not affect in any way the processing of AS Transfer Initiation (ASTI) files received via SWIFTNet even for an AS belonging to a CB in contingency mode.

All ASI procedures are supported in contingency mode.

Standard processing for all procedures

ASTransferInitiation files (ASTI) are processed by a file upload functionality in ICM. The CB or SSP OT on behalf of the CB selects the ASTransferInitiation file which has been prepared by the CB or transferred by the AS to the CB by bilaterally agreed means - in a local directory from the ICM interface. The file has to be compliant with the current sending on behalf scenario ie the CB has to add the AS BIC in the initiating party.

ICM provides the information about file upload status including error information to the CB/SSP OT user. All ASTI files received by ASI through the new ICM functionality are processed as other ASTI files sent on behalf of an AS by its CB. However no notification (ASTransferNotice, ReturnAccount, MT 900/910) are sent to the AS and to the settlement bank. The CB of the AS has to use the ICM screen to monitor the settlement status of the ASTI and the related bookings.

Special features for procedure 4/5

It is possible to process Receipt AS via the new ICM upload functionality to confirm or reject the guarantee mechanism.

Special feature for procedure 6

Daylight and night-time businesses can be managed by the standard ICM screen.

Therefore no special feature for settlement procedure 6 is necessary in contingency mode.

2.9 Interconnection with TARGET2 Securities

Overview

The Eurosystem's single technical platform TARGET2 Securities (T2S) enables central securities depositories (CSDs) and national central banks to provide core, borderless and neutral securities settlement services in central bank money in Europe. One of the main prerequisites for successful settlement is the efficient liquidity supply of central bank money by the European RTGS systems. The major counterparty and T2S actor covering this requirement is the TARGET2 system.

The interconnection between TARGET2 and T2S is based on an application-to-application approach. The TARGET2 interconnection to T2S facili-

tates mainly the provision of euro denominated liquidity transfers from TARGET2 RTGS accounts to T2S Dedicated Cash Accounts and vice versa during the TARGET2 business day.

2.9.1 TARGET2 Securities Interface (T2SI)

The connection of T2S to TARGET2 is considered and built as a new dedicated interface specially designed for T2S, called T2S interface (T2SI).

Dedicated Interface

System-to-system connectivity

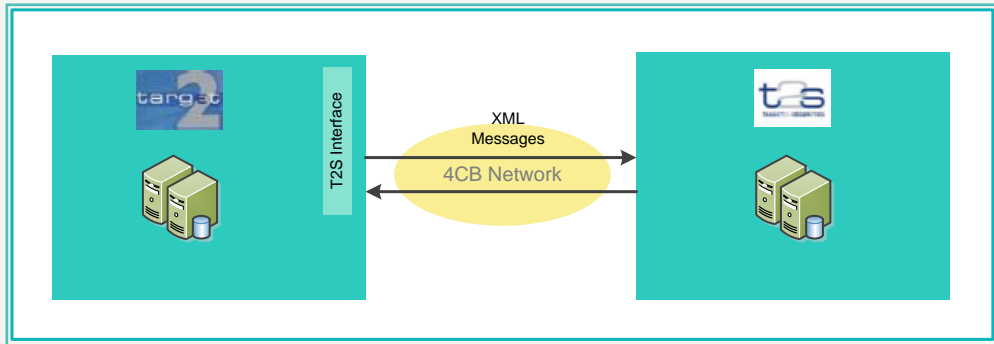

The system-to-system connection between TARGET2 and T2S is based on the internal 4CB network and uses the same XML message standard as required by the T2S specifications.

In line with the T2S specifications, all messages exchanged between TARGET2 and T2S will use the Business Application Header (BAH).

2 User Guide for Payments Module (PM)

2.9 Interconnection with TARGET2 Securities

2.9.1 TARGET2 Securities Interface (T2SI)

System-to-user connectivity

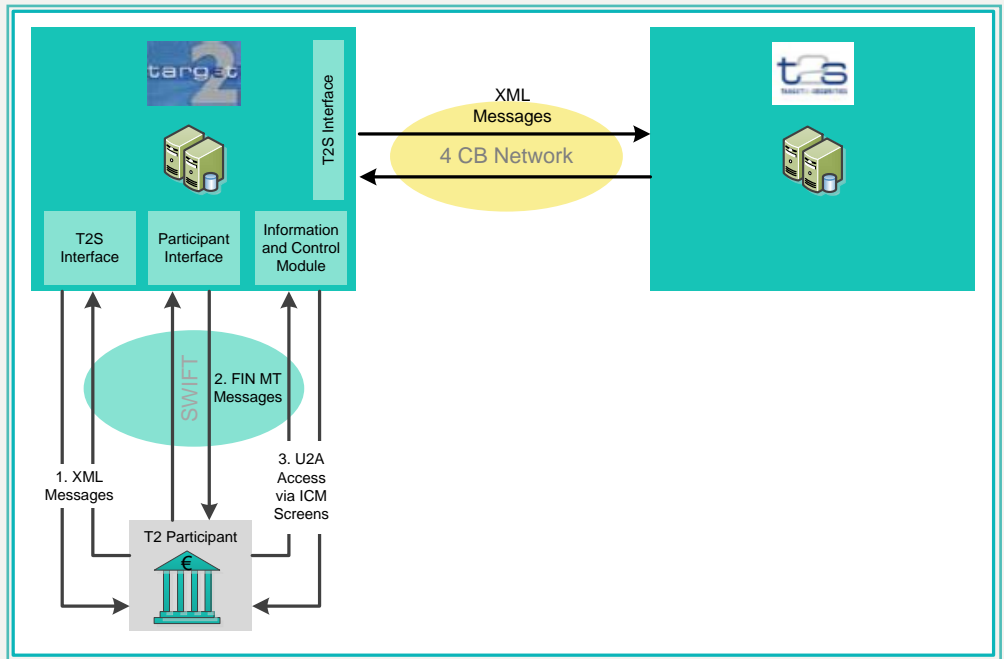

A direct participant will have 3 interfaces to TARGET2 to instruct T2S related business cases:

1. A2A (XML messages) via the T2S interface
2. FIN (MT messages) via the participant interface and
3. U2A via the Information and Control Module.

The connection between TARGET2 and the direct participants is based on the SWIFT network.

The message standard used for the T2S-related A2A XML message exchange between the direct participant and TARGET2 in both directions will always be the same message standard as used for the interconnection with T2S.

Business Application Header

For the XML message exchange between TARGET2 and the TARGET2 participants the Business Application Header (BAH) is not used, while it is used for the system-to-system message exchange between TARGET2 and T2S. TARGET2 will add or remove the BAH accordingly.

2.9.2 Overview of provided services

Core and Value added services

The services provided by TARGET2 in connection with T2S are divided into mandatory core services and optional value added services.

The core services are focusing on the liquidity management with T2S for participants having migrated to the XML message standard required by T2S.

The optional value added services are envisaged for those TARGET2 direct participants having not migrated their cash and liquidity management operations to the new XML message standard. In addition they can also bring benefits to users having migrated their cash and liquidity management operations to the new XML message standard as they provide an alternative in case of contingency and can be helpful also regardless of contingency, as for example they do not impose to the users a direct connection to T2S, which implies the usage of the BAH. The value added services are only provided as a whole package.

The following table provides an overview of the services provided by TARGET2 related to T2S business and indicates by which technical means they are made available on either mandatory (core services) or optional basis (value added services):

Service	FN MT	ICM/U2A	A2A (T2S XML standard)
Current order liquidity transfer "push" to T2S	O	M	M
Current order liquidity transfer "pull" from T2S	O	O	O

2 User Guide for Payments Module (PM)

2.9 Interconnection with TARGET2 Securities

2.9.2 Overview of provided services

Service	FN MT	ICM/U2A	A2A (T2S XML standard)
Standing order liquidity transfer “push” to T2S (set up in SD)	-	M	M
Current order liquidity transfer “push” to T2S by T2S Actor in TARGET2	-	-	M
Debit notification for liquidity transfer “push” on RTGS	M	M*	M
Information on incoming liquidity transfer from T2S	M	M*	M
DCA intraday balance	-	O	O

* via standard payments monitoring

M: Service available as part of the TARGET2 core services

O: Service available as value added service in TARGET2

-: Service not available in TARGET2

2.9.2.1 Core services

Standing order liquidity transfer (“push”)

A standing order liquidity transfer is an automatically executed instruction of a fixed amount of liquidity from the RTGS account of the direct participant to any euro denominated DCA in T2S. The standing order liquidity transfers can be captured directly via ICM in U2A mode or via XML message in A2A mode by the RTGS account holder or its responsible CB. The details captured in the Static Data Module before the start of the end-of-day processing will become active on the next business day (earliest activation date). The same principle applies for standing order modifications. The processing of the standing order liquidity transfers - outgoing messages and incoming confirmations - can be monitored via ICM.

Current order liquidity transfer (“push“)

A current order liquidity transfer to T2S is an immediate transfer of liquidity from the RTGS account of a direct participant to any euro denominated T2S DCA. It can be initiated by the RTGS account holder, its responsible CB, the group of accounts (GoA) manager to which the RTGS account belongs, or any other authorised T2S Actor in TARGET2 (eg CSD) on behalf of the direct participant. The current order liquidity transfer can be submitted via ICM (U2A) or via XML message in the standard supported by T2S. For T2S Actors in TARGET2 the initiation is restricted to the A2A approach via XML message only. Current order liquidity transfers are executed by start of the new business day from 19.30 (interrupted by the maintenance window from 22.00 to 01.00) and during the TARGET2 day trade phase till the cut-off for liquidity transfers to T2S (17.45). The processing of the current order liquidity transfers - outgoing messages and incoming confirmations - can be monitored during the processing times via ICM.

Debit notification for standing and current order liquidity transfers

For the execution of the following liquidity transfers from RTGS account to any euro denominated DCA in T2S a notification via XML message BanktoCustomerDebitNotification or SWIFT FIN message MT 900 can be provided to the direct participant on an optional basis:

- Standing order liquidity transfers
- Current order liquidity transfer initiated in ICM (U2A)
- Current order liquidity transfer initiated by authorised T2S Actors in TARGET2 or other third parties (CB or GoA manager on behalf)

The flag for the selected notification is stored in Static Data.

Incoming liquidity transfers from T2S are processed in TARGET2 at any time excluding the end-of-day and start-of-day processing (from 18.00 to 19.30) and the technical maintenance window (from 22.00 to 01.00). As the balance on the Dedicated Cash Accounts in T2S have to be zero at the end of the T2S business day, all liquidity retransfers to RTGS accounts in TARGET2 must be processed before the end-of-day processing (beginning 18.00). The direct participant is informed about the booking on its RTGS account via SWIFT FIN message MT 202 or XML LiquidityCreditTransfer message if he has opted for either one of these messages. The flag for the

Incoming liquidity transfer from T2S

selected notification also offers not to receive any notification and is stored in the Static Data.

Current order liquidity transfer via SWIFT FIN message MT 202 (“push“)

2.9.2.2 Value Added Services

A current order liquidity transfer to T2S via SWIFT FIN message MT 202 is an instruction with immediate effect from the RTGS account of a direct participant to any euro denominated T2S DCA. It can be initiated by the RTGS account holder or its responsible CB via mandated payment. The current order liquidity transfer initiated via MT 202 is processed in TARGET2 according to the same rules as the transfer initiated via XML LiquidityCreditTransfer message.

Current order liquidity transfer from T2S DCA to RTGS account (“pull“)

This service offers the possibility to submit current order liquidity transfers from an euro denominated DCA in T2S (linked to the initiating direct TARGET2 participant) to any RTGS account in TARGET2. It can be initiated by a direct participant or its responsible CB in TARGET2 via:

- XML LiquidityCreditTransfer message
- SWIFT FIN message - MT 202 (not possible as mandated payment from CB)
- Directly in ICM (U2A)

The T2S response is an incoming current order liquidity transfer which is processed in TARGET2 as a new independent business case. The amount of this liquidity transfer can however deviate from the ordered amount. In this case a partial execution in T2S took place. The time constraints for the processing of “pull“ current order liquidity transfers are the same as for the “push“ current orders except for the T2S technical maintenance window during which no liquidity transfers in T2S will be processed. The respective error message is displayed under RTGS - Payments and Messages - Display messages.

Note: A time indication for a MT 202 introducing a pull Liquidity Credit Transfer from T2S is not allowed due to technical restrictions. Furthermore mandated payments are not applicable to pull liquidity messages from T2S.

T2S DCA intraday balance

The TARGET2 direct participants can monitor the balances of the T2S DCAs linked to their RTGS accounts directly in ICM (U2A) or request the DCA balance via XML message (A2A). For each DCA balance a separate XML request must be sent.

The liquidity view on the RTGS and its related T2S DCA balances are displayed in the same ICM screen which enables the direct participants, their responsible CB or the GoA manager to monitor the overall liquidity position in both systems.

2.9.3 Flow of Liquidity Transfers

Basics

The main services of the interconnection with T2S are the execution of euro denominated liquidity transfers from TARGET2 RTGS accounts to T2S Dedicated Cash Accounts and vice versa.

Transit account

For the settlement of liquidity transfers between TARGET2 and T2S an off-set account in each system is used. In TARGET2 this offset account is called T2S transit account; in T2S it is called T2 transit account.

The following chapter gives an overview of the flow of messages between the direct participant and TARGET2 as well as between TARGET2 and T2S.

Note: The flows are always referring to a successful processing on TARGET2 and T2S side.

2.9.3.1 Push Liquidity to T2S

Basics

All direct participants with an RTGS account can transfer liquidity to any euro denominated DCA in T2S. This is valid for current as well as for standing orders.

The T2S DCAs, which will be credited in T2S, are not validated by TARGET2. In case of a rejection by T2S (eg because of unknown DCA number or DCA related to another currency) the liquidity transfer is automatically

2.9 Interconnection with TARGET2 Securities

2.9.3 Flow of Liquidity Transfers

“unwinded” via a reversal booking in favour of the RTGS account of the initiating TARGET2 participant.

2.9.3.1.1 Standing orders

Main attributes

Processing time in TARGET2	Event-executed at the beginning of the phase “Settlement of AS night-time processing” (19.30). Note: The phase “Settlement of AS night-time processing” starts fifteen minutes later on the last day of the minimum reserve period.
Priority in PM	highly urgent
Consequences in case of lack of funds	Pro rata execution of all standing orders executed at the execution event (ie together with the ASI and TIPS standing orders).
Consequences in case of excluded sending participant in TARGET2	No liquidity transfer will be triggered. Current orders have to be used instead.

2 User Guide for Payments Module (PM)

2.9 Interconnection with TARGET2 Securities

2.9.3 Flow of Liquidity Transfers

Flow of standing order liquidity transfer to T2S

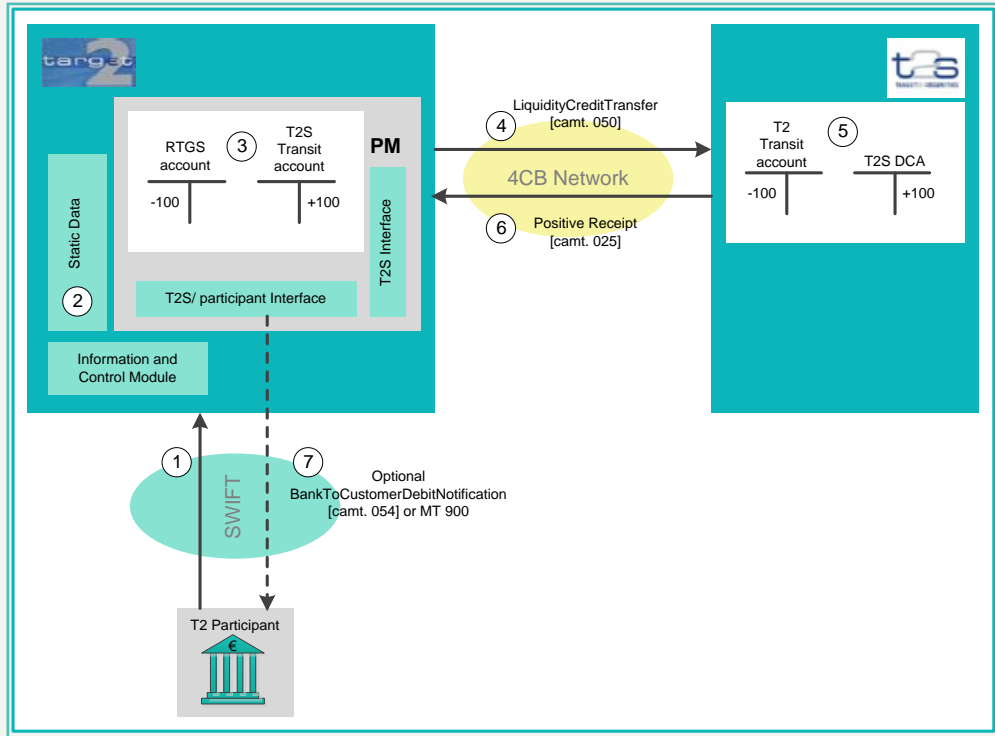

Step	Processing in/between	Description
1	TARGET2 part. → TARGET2	The TARGET2 participant captures a standing order liquidity transfer from TARGET2 to T2S via ICM or transmits the Modify Standing Order message via A2A.
2	TARGET2	The standing order is stored in TARGET2 SD and forwarded to PM from its activation date via SD loading. Note: The activation date for standing orders is always D+1 in SD.
3	TARGET2	When the phase "Settlement of AS night-time processing" is

2 User Guide for Payments Module (PM)

2.9 Interconnection with TARGET2 Securities

2.9.3 Flow of Liquidity Transfers

Step	Processing in/between	Description
		started the standing orders are executed by debiting the RTGS account of the ordering TARGET2 participant and crediting the T2S transit account.
4	TARGET2 → T2S	A LiquidityCreditTransfer with BAH is sent from TARGET2 to T2S via the 4CB network.
5	T2S	The liquidity transfer is validated. In case of successful validation the TARGET2 transit account is debited and the DCA specified in the liquidity transfer is credited.
6	T2S → TARGET2	T2S sends a positive Receipt to TARGET2 via the 4CB network.
7	TARGET2 → TARGET2 part.	TARGET2 sends an optional BankToCustomerDebitNotification or an MT 900 depending on the flag for T2S related notifications (stored in SD) to the TARGET2 direct participant via SWIFT. Note: In case of BankToCustomerDebitNotification: The receiving DN is the DN stored in SD for this notification service. In case the Receipt from T2S in step 6 is negative (due to rejection on T2S side), no optional BankToCustomerDebitNotification or MT 900 is sent to the TARGET2 participant after the reversal booking.

2.9.3.1.2 Current orders by account owner

2.9.3.1.2.1 Initiation via XML message

Main attributes

Processing time in TARGET2	<p>From start of phase "Settlement of AS night-time processing" till the dedicated cut-off time for T2S business (19.30 - 17.45) except TARGET2 maintenance window (22.00 - 01.00).</p> <p>Messages received between Cut-off for T2S and Cut-off for Message Input will be rejected.</p> <p>Messages received after Cut-off for Message Input (currently 18.30) are stored (not visible in ICM) for the later processing.</p> <p>Note: The phase "Settlement of AS night-time processing" starts fifteen minutes later on the last day of the minimum reserve period.</p>
Warehouse functionality	no
Consequences in case of lack of funds	Daylight phases (07.00 - 17.45): Queuing Night-time phases (19.30 - 07.00): Rejection
Consequences in case of highly urgent payments submitted earlier and already pending in queue	Daylight phases (07.00 - 17.45): Queuing Night-time phases (19.30 - 07.00): Rejection
Special cases	Dedicated work as scenario according to DN-BIC matching table is possible for T2S Actor in TARGET2 (see chapter 2.9.3.1.3 Current orders by T2S Actors in TARGET2 initiated via XML message, page 283).

2 User Guide for Payments Module (PM)

2.9 Interconnection with TARGET2 Securities

2.9.3 Flow of Liquidity Transfers

Flow of current order liquidity transfer to T2S initiated via XML message - case: positive Receipt from T2S

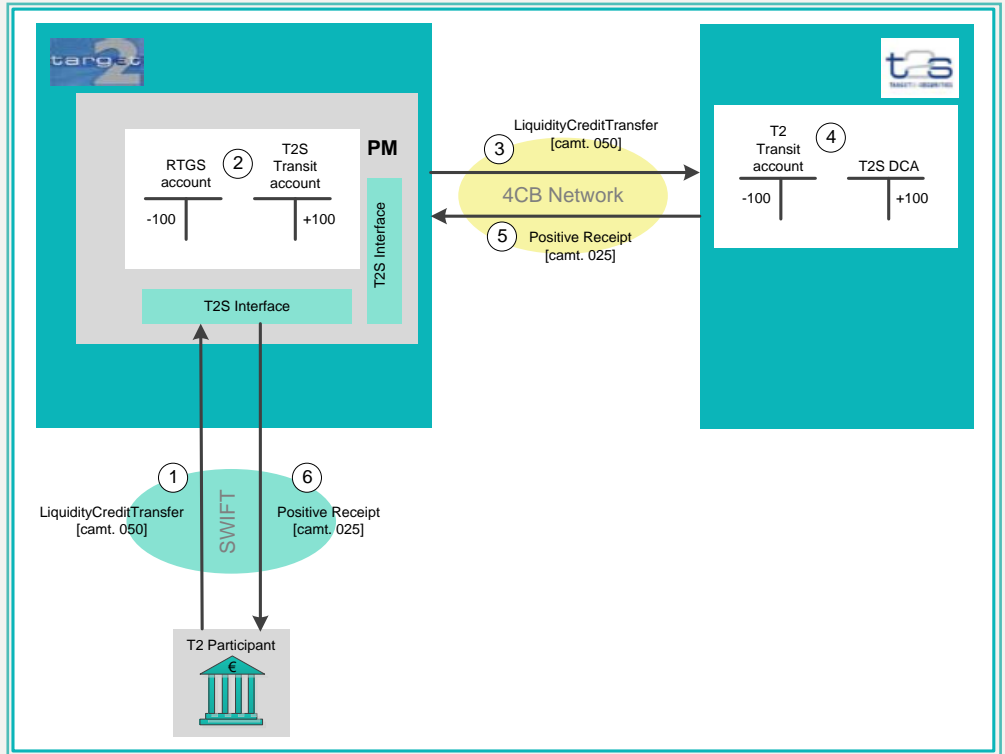

Step	Processing in/between	Description
1	TARGET2 part. → TARGET2	The TARGET2 participant sends a LiquidityCreditTransfer without BAH for the initiation of a liquidity transfer from TARGET2 to T2S via SWIFT. Note: The sending DN is the DN matching the participant BIC in the DN-BIC matching table.
2	TARGET2	The liquiditytransfer is validated. In case of successful validation the RTGS account of the ordering TARGET2 participant is debited and the T2S transit account is credited.

2 User Guide for Payments Module (PM)

2.9 Interconnection with TARGET2 Securities

2.9.3 Flow of Liquidity Transfers

Step	Processing in/between	Description
3	TARGET2 → T2S	A LiquidityCreditTransfer with BAH is sent from TARGET2 to T2S via the 4CB network.
4	T2S	The liquiditytransfer is validated. In case of successful validation the T2 Transit account is debited and the DCA specified in the liquiditytransfer is credited.
5	T2S → TARGET2	T2S sends a positive Receipt to TARGET2 via the 4CB network.
6	TARGET2 → TARGET2 part	TARGET2 sends a positive Receipt to the TARGET2 participant via SWIFT. Note: The receiving DN is the DN of the business case initiator (sender of the LiquidityCreditTransfer - see step 1).

2 User Guide for Payments Module (PM)

2.9 Interconnection with TARGET2 Securities

2.9.3 Flow of Liquidity Transfers

Flow of current order liquidity transfer to T2S initiated via XML message - case: negative Receipt from T2S

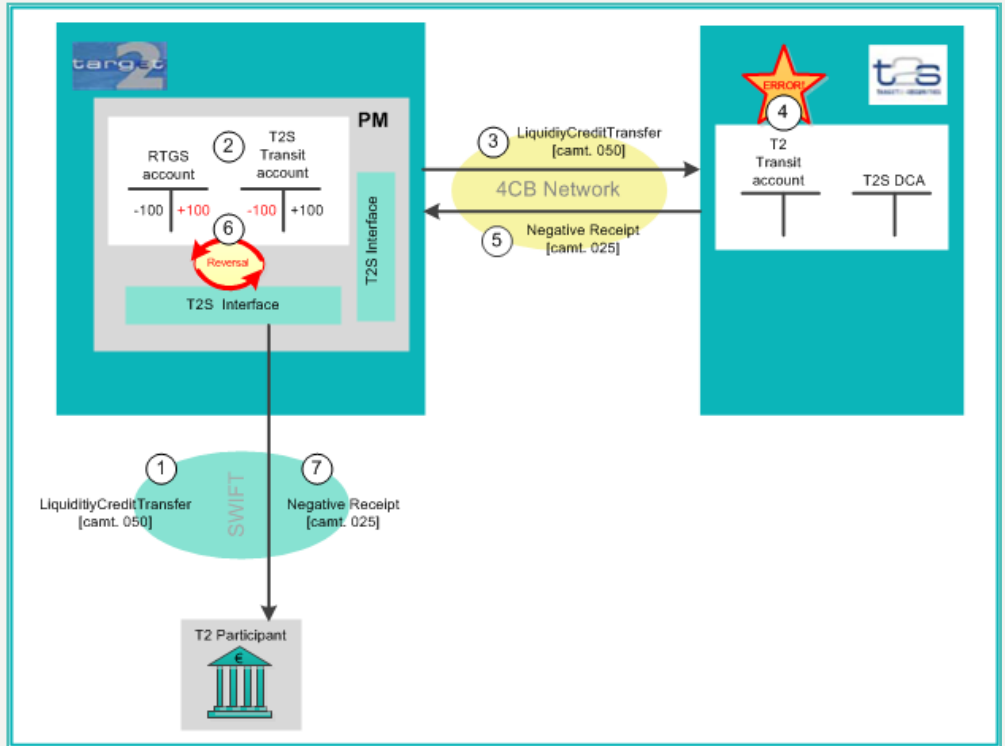

Step	Processing in/between	Description
1	TARGET2 part. → TARGET2	The TARGET2 participant sends a LiquidityCreditTransfer without BAH for the initiation of a liquidity transfer from TARGET2 to T2S via SWIFT. Note: The sending DN is the DN matching the participant BIC in the DN-BIC matching table.
2	TARGET2	The liquidity transfer is validated. In case of successful validation the RTGS account of the ordering TARGET2 participant is debited and the T2S transit account is credited.

2 User Guide for Payments Module (PM)

2.9 Interconnection with TARGET2 Securities

2.9.3 Flow of Liquidity Transfers

Step	Processing in/between	Description
3	TARGET2 → T2S	A LiquidityCreditTransfer with BAH is sent from TARGET2 to T2S via the 4CB network.
4	T2S	The liquidity transfer is validated with error (eg unknown creditor DCA). Due to the error the liquidity transfer is not settled in T2S.
5	T2S → TARGET2	T2S sends a negative Receipt with the respective T2S error code to TARGET2 via the 4CB network.
6	TARGET2	The booking of step 2 is automatically reversed, ie the T2S transit account is debited and the RTGS account of the ordering TARGET2 participant is credited.
7	TARGET2 → TARGET2 part	TARGET2 sends a negative Receipt including the first error code reported by T2S (meaning can be checked with the T2S UDFS) to the TARGET2 participant via SWIFT. Note: The receiving DN is the DN of the business case initiator (sender of the LiquidityCreditTransfer - see step 1).

2.9.3.1.2.2 Initiation via MT message (Value added service)

Main attributes

Processing time in TARGET2	<p>From start of phase “Settlement of AS night-time processing” till the dedicated cut-off time for T2S business (19.30 - 17.45) except TARGET2 maintenance window (22.00 - 01.00).</p> <p>Messages received between Cut-off for T2S and Cut-off for Message Input will be rejected. Messages received after Cut-off for Message Input (currently 18.30) are stored (not visible in ICM) for the later processing. The usage of earliest and latest execution times is possible.</p> <p>Note: The phase “Settlement of AS night-time processing” starts fifteen minutes later on the last day of the minimum reserve period.</p>
Warehouse functionality	no
Priority in PM	highly urgent
Consequences in case of lack of funds	Daylight phases (07.00 - 17.45): Queuing Night-time phases (19.30 - 07.00): Rejection
Consequences in case of highly urgent payments submitted earlier and already pending in queue	Daylight phases (07.00 - 17.45): Queuing Night-time phases (19.30 - 07.00): Rejection
Special cases	Sending as mandated payment by the responsible CB on behalf of the participant is possible.

2 User Guide for Payments Module (PM)

2.9 Interconnection with TARGET2 Securities

2.9.3 Flow of Liquidity Transfers

Flow of current order liquidity transfer to T2S initiated via MT message - case: positive Receipt from T2S

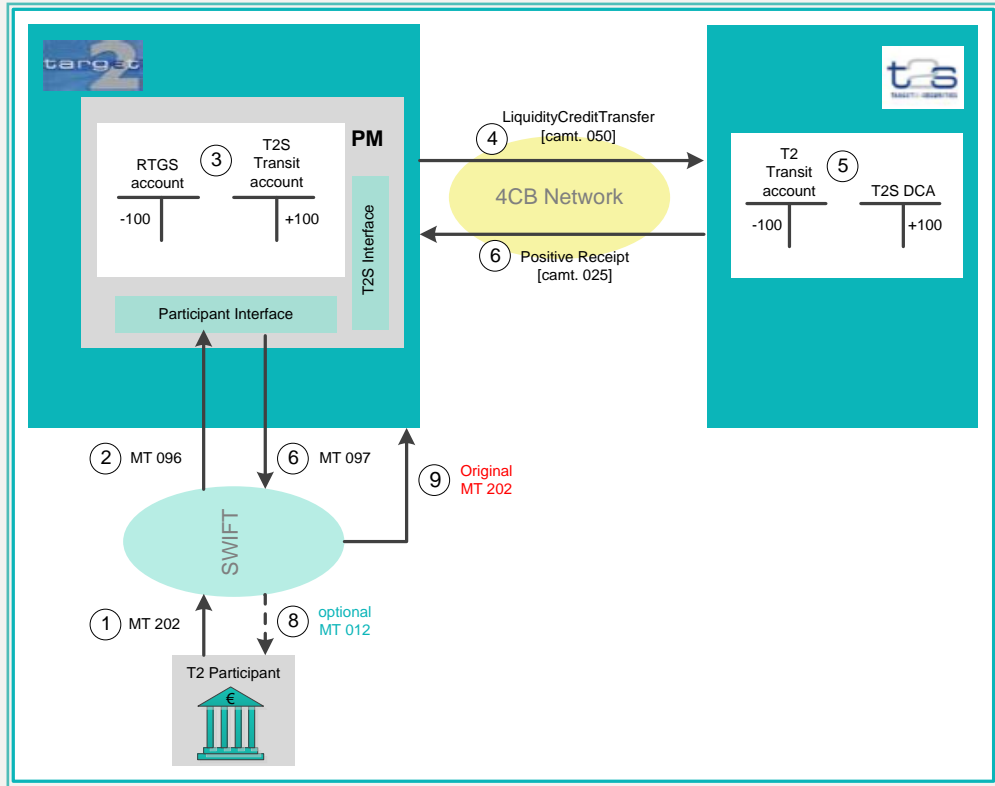

Step	Processing in/between	Description
1	TARGET2 part. → SWIFT	The direct participant sends an MT 202 (Y-Copy) for the initiation of a liquiditytransfer from TARGET2 to T2S via SWIFT. Note: The receiver BIC in the message header is the dedicated technical T2S BIC in TARGET2, TRGTXEPM2S.
2	SWIFT → TARGET2	SWIFT sends a copy (MT 096) of the message to TARGET2.
3	TARGET2	The liquiditytransfer is validated. In case of successful valida-

2 User Guide for Payments Module (PM)

2.9 Interconnection with TARGET2 Securities

2.9.3 Flow of Liquidity Transfers

Step	Processing in/between	Description
		tion the RTGS account of the ordering TARGET2 participant is debited and the T2S transit account is credited.
4	TARGET2 → T2S	The MT 202 (MT 096) is converted into a LiquidityCreditTransfer with BAH which is sent from TARGET2 to T2S via the 4CB network.
5	T2S	The liquiditytransfer is validated. In case of successful validation the T2 Transit account is debited and the DCA specified in the liquiditytransfer is credited.
6	T2S → TARGET2	T2S sends a positive Receipt to TARGET2 via the 4CB network.
7	TARGET2 → SWIFT	TARGET2 sends the positive notification MT 097 to SWIFT.
8	SWIFT → TARGET2 participant	SWIFT sends an MT 012 on optional basis to the TARGET2 participant.
9	SWIFT → TARGET2	The original MT 202 is forwarded to TARGET2 for business case assignment.

2 User Guide for Payments Module (PM)

2.9 Interconnection with TARGET2 Securities

2.9.3 Flow of Liquidity Transfers

Flow of current order liquidity transfer to T2S initiated via MT message - case: negative Receipt from T2S

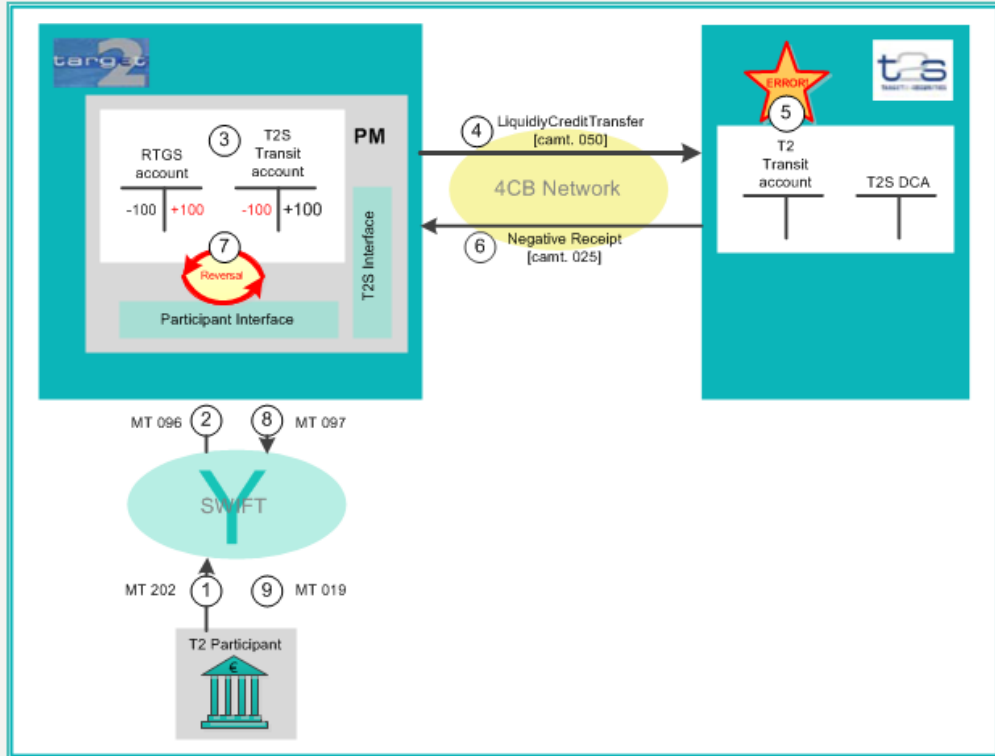

Step	Processing in/between	Description
1	TARGET2 part. → SWIFT	The direct participant sends an MT 202 (Y-Copy) for the initiation of a liquidity transfer from TARGET2 to T2S via SWIFT. Note: The receiver BIC in the message header is the dedicated technical T2S BIC in TARGET2, TRGTXEPMT2S.
2	SWIFT → TARGET2	SWIFT sends a copy (MT 096) of the message to TARGET2.
3	TARGET2	The liquidity transfer is validated. In case of successful validation the RTGS account of the ordering TARGET2 participant is

Step	Processing in/between	Description
		debited and the T2S transit account is credited.
4	TARGET2 → T2S	The MT 202 (MT 096) is converted into a LiquidityCreditTransfer with BAH which is sent from TARGET2 to T2S via the 4CB network.
5	T2S	The liquidity transfer is validated with error (eg unknown creditor DCA). Due to the error the liquidity transfer is not settled in T2S.
6	T2S → TARGET2	T2S sends a negative Receipt with the respective T2S error code to TARGET2 via the 4CB network.
7	TARGET2	The booking of step 3 is automatically reversed, ie the T2S transit account is debited and the RTGS account of the ordering TARGET2 participant is credited.
8	TARGET2 → SWIFT	TARGET2 sends the negative notification MT 097 to SWIFT.
9	SWIFT → TARGET2 participant	SWIFT sends an MT 019 to the TARGET2 participant. Note: Due to the limitation of the MT message format it is not possible to report the precise T2S error code. The contained TARGET2 Y-copy error code just indicates that the liquidity transfer was rejected by T2S. The precise T2S error code is reported in ICM and can be checked with the T2S UDFS.

2.9.3.1.2.3 Initiation via ICM

Main attributes

Processing time in TARGET2	From start of phase “Settlement of AS night-time processing” till the dedicated cut-off time for T2S business (19.30 - 17.45) except TARGET2 maintenance window (22.00 - 01.00). Note: The phase “Settlement of AS night-time processing” starts fifteen minutes later on the last day of the minimum reserve period.
Priority in PM	highly urgent
Consequences in case of lack of funds	Daylight phases (07.00 - 17.45): Queuing Night-time phases (19.30 - 07.00): Rejection
Consequences in case of highly urgent payments submitted earlier and already pending in queue	Daylight phases (07.00 - 17.45): Queuing Night-time phases (19.30 - 07.00): Rejection

2 User Guide for Payments Module (PM)

2.9 Interconnection with TARGET2 Securities

2.9.3 Flow of Liquidity Transfers

Flow of current order liquidity transfer to T2S initiated via ICM (U2A)

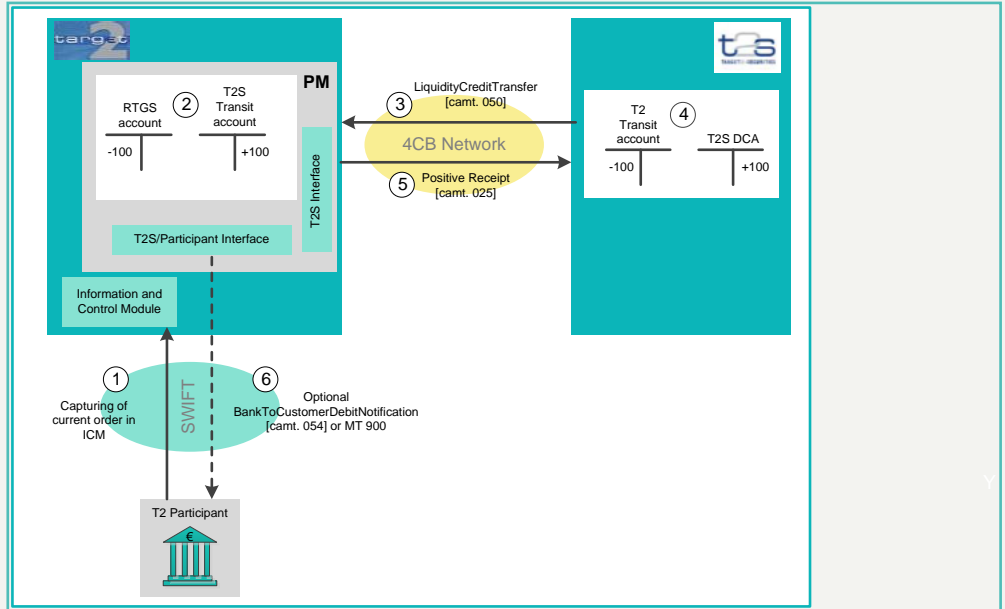

Step	Processing in/between	Description
1	TARGET2 part. → TARGET2	A direct participant initiates a liquidity transfer from TARGET2 to T2S via TARGET2 ICM.
2	TARGET2	The liquidity transfer is validated. In case of successful validation the RTGS account of the ordering TARGET2 participant is debited and the T2S transit account is credited.
3	TARGET2 → T2S	A LiquidityCreditTransfer with BAH is sent from TARGET2 to T2S via the 4CB network.

Step	Processing in/between	Description
4	T2S	The liquidity transfer is validated. In case of successful validation the TARGET2 transit account is debited and the DCA specified in the liquidity transfer is credited.
5	T2S → TARGET2	T2S sends a positive Receipt to TARGET2 via the 4CB network.
6	TARGET2 → TARGET2 part.	TARGET2 sends an optional BankToCustomerDebitNotification or an MT 900 depending on the flag for T2S related notifications (stored in SD) to the TARGET2 participant via SWIFT. Note: In case of BankToCustomerDebitNotification: The receiving DN is the DN stored in SD for this notification service. In case the Receipt from T2S in step 5 is negative (due to rejection on T2S side), no optional BankToCustomerDebitNotification or MT 900 is sent to the TARGET2 participant after the reversal booking.

2.9.3.1.3 Current orders by T2S Actors in TARGET2 initiated via XML message

Basics

T2S Actor in TARGET2 will be able to work as/act on behalf TARGET2 participants, ie to initiate in TARGET2 current order liquidity transfers to T2S via XML message.

The following T2S Actor in TARGET2 can be distinguished:

- CSDs
- Other parties

T2S Actors in TARGET2 are assigned to a dedicated A2A role ('APPLICATIONDTE') and have to be authorised by the TARGET2 participant they want to work for. This authorisation is stored in the DN-BIC matching table in SD.

2.9 Interconnection with TARGET2 Securities

2.9.3 Flow of Liquidity Transfers

The dedicated T2S Actor in TARGET2 DN is registered with the actor type “T2S Actor in TARGET2” in the DN-BIC matching table in relation to the TARGET2 participants for which the T2S Actor in TARGET2 need to work as. The T2S Actor in TARGET2 DN cannot be used for other actor types in parallel (eg AS or CI).

Main attributes

Processing time in TARGET2	From start of phase “Settlement of AS night-time processing” till the dedicated cut-off time for T2S business (19.30 - 17.45) except TARGET2 maintenance window (22.00 - 01.00). Messages received between Cut-off for T2S and Cut-off for Message Input will be rejected. Messages received after Cut-off for Message Input (currently 18:30) are stored (not visible in ICM) for the later processing. Note: The phase “Settlement of AS night-time processing” starts fifteen minutes later on the last day of the minimum reserve period.
Warehouse functionality	no
Priority in PM	highly urgent
Consequences in case of lack of funds	Daylight phases (07.00 - 17.45): Queuing Night-time phases (19.30 - 07.00): Partial execution
Consequences in case of highly urgent payments submitted earlier and already pending in queue	Daylight phases (07.00 - 17.45): Queuing Night-time phases (19.30 - 07.00): Rejection (no available liquidity) or partial settlement (If available liquidity > 0 but less than the ordered amount).

2 User Guide for Payments Module (PM)

2.9 Interconnection with TARGET2 Securities

2.9.3 Flow of Liquidity Transfers

Flow of current order liquidity transfer to T2S initiated via XML message by T2S Actor in TARGET2

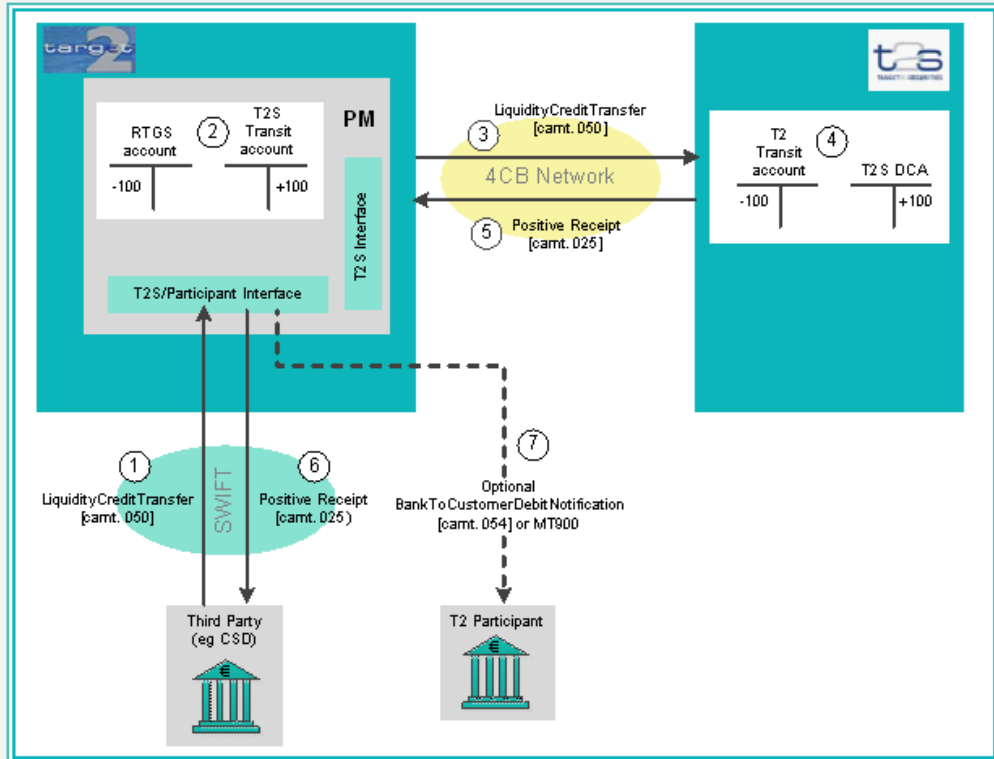

Step	Processing in/between	Description
1	T2S Actor in TARGET2 → TARGET2	A T2S Actor in TARGET2 (eg CSD) sends a LiquidityCreditTransfer on behalf of the direct participant for the initiation of a liquiditytransfer from TARGET2 to T2S via SWIFT. Note: The validity of the assignment of the senders DN to the participant BIC can be checked on basis of DN-BIC matching table.
2	TARGET2	The liquiditytransfer is validated. In case of successful validation the RTGS account of the ordering TARGET2 participant is

2 User Guide for Payments Module (PM)

2.9 Interconnection with TARGET2 Securities

2.9.3 Flow of Liquidity Transfers

Step	Processing in/between	Description
		debited and the T2S transit account is credited. Note: In case the available liquidity is greater than zero but less than the instructed amount, the available liquidity is used for partial execution during night time phases.
3	TARGET2 → T2S	A LiquidityCreditTransfer with BAH is sent from TARGET2 to T2S via the 4CB network.
4	T2S	The liquidity transfer is validated. In case of successful validation the TARGET2 transit account is debited and the DCA specified in the liquidity transfer is credited.
5	T2S → TARGET2	T2S sends a positive Receipt to TARGET2 via the 4CB network.
6	TARGET2 → T2S Actor in TARGET2	TARGET2 sends a positive Receipt to the initiating T2S Actor in TARGET2 (eg CSD) via SWIFT. Note: The receiving DN is the DN of the business case initiator (sender of the LiquidityCreditTransfer - see step 1). Two different positive status codes can occur - first one indicates successful movement of the instructed amount to T2S, the other one notifies partial execution of the instruction. The latter case only occurs during night time phases and reports the settlement amount.
7	TARGET2 → TARGET2 part.	TARGET2 sends an optional BankToCustomerDebitNotification or an MT 900 depending on the flag for T2S related notifications (stored in SD) to the TARGET2 participant via SWIFT. Note: In case of BankToCustomerDebitNotification: The receiving DN is the DN stored in SD for this notification service.

2.9.3.2 Incoming Liquidity Transfers from T2S

A T2S actor (dependent from the access rights defined in T2S) can initiate an immediate Liquidity Transfer in T2S to any RTGS account in TARGET2 (except AS-related and technical ones). Liquidity Transfers to the RTGS ac-

2 User Guide for Payments Module (PM)

- 2.9 Interconnection with TARGET2 Securities
- 2.9.3 Flow of Liquidity Transfers

Basics

count can be also triggered by standing and predefined orders in T2S. Another possibility is the manual or automated cash-sweep of the T2S Dedicated Cash Accounts to the linked RTGS account at T2S end of day. The processing of the Liquidity Transfer message sent by T2S is for all cases the same in TARGET2.

Main attributes

Processing time in TARGET2	From start of phase "Settlement of AS night-time processing" till last run of algorithm (19.30 – shortly after 18.00) except maintenance window (22.00 - 01.00). Note: The phase "Settlement of AS night-time processing" starts fifteen minutes later on the last day of the minimum reserve period.
Priority in PM	highly urgent

Flow of incoming liquidity transfers from T2S

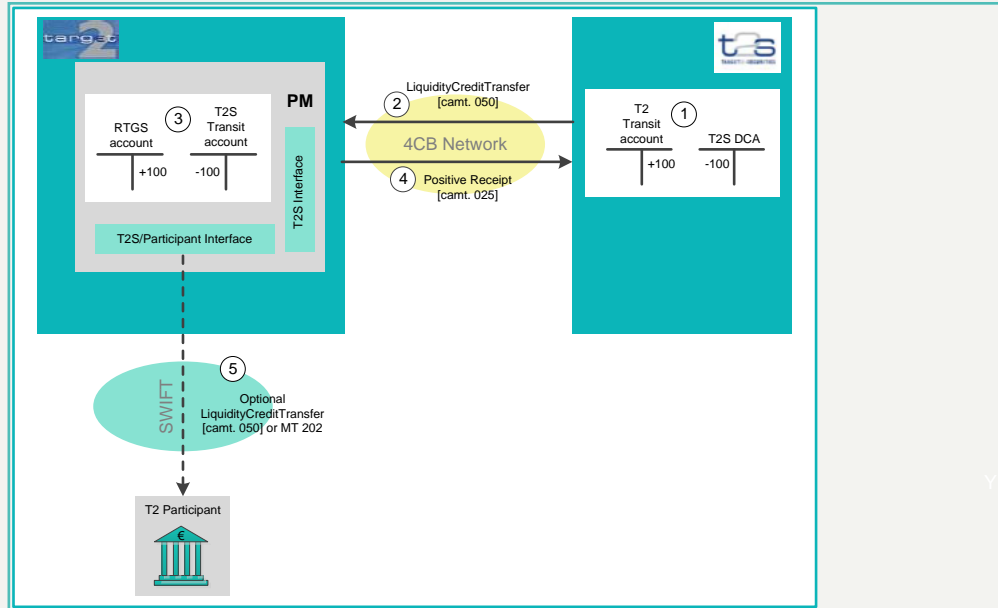

2 User Guide for Payments Module (PM)

2.9 Interconnection with TARGET2 Securities

2.9.3 Flow of Liquidity Transfers

Step	Processing in/between	Description
1	T2S	The liquidity transfer (outbound liquidity transfer) initiated on T2S side is executed: The specified DCA is debited and the TARGET2 transit account is credited.
2	T2S → TARGET2	A LiquidityCreditTransfer is sent from T2S to TARGET2 via the 4CB network.
3	TARGET2	The liquidity transfer is validated. In case of successful validation the T2S transit account is debited and the RTGS account of the TARGET2 participant specified in the liquidity transfer is credited.
4	TARGET2 → T2S	TARGET2 sends a positive Receipt to T2S via the 4CB network.
5	TARGET2 → TARGET2 part.	TARGET2 sends a LiquidityCreditTransfer or an MT 202 on an optional basis depending on the flag for T2S related push messages stored in SD to the TARGET2 participant via SWIFT. Note: In case of LiquidityCreditTransfer: The receiving DN is the DN stored in SD for this service.

2.9.3.3 Pull Liquidity from T2S (Value added service)

Basics

T2S participants with RTGS account in TARGET2 will also have the possibility to initiate a Liquidity Transfer from the T2S DCA linked to their RTGS account to any RTGS account in TARGET2 (except AS-related and technical ones) via MT message, MX message or via ICM. For this purpose TARGET2 will send the immediate liquidity transfer to T2S on behalf of the direct participant and T2S will generate an outbound liquidity transfer to TARGET2 via the 4CB network.

This value added service is only available for those participants who have opted for it.

2 User Guide for Payments Module (PM)

2.9 Interconnection with TARGET2 Securities

2.9.3 Flow of Liquidity Transfers

Main attributes

Processing time in TARGET2	<p>From start of phase “Settlement of AS night-time processing” till the dedicated cut-off time for T2S business (19.30 - 17.45) except TARGET2 maintenance window (22.00 - 01.00).</p> <p>For initiation via MX or MT message the following rules apply:</p> <ul style="list-style-type: none">• Messages received between Cut-off for T2S and Cut-off for Message Input (18.30) will be rejected.• Messages received after Cut-off for Message Input (18.30) are stored (not visible in ICM) for the later processing. <p>Initiation via ICM depends on the accessibility of the respective screens and is possible only within the above mentioned timeframe (19.30 - 17.45) except TARGET2 maintenance window (22.00 - 01.00).</p> <p>Note: The phase “Settlement of AS night-time processing” starts fifteen minutes later on the last day of the minimum reserve period.</p>
Warehouse functionality	no
Priority in PM	highly urgent
Consequences in case of lack of funds	Partial execution on T2S side possible (ie deviation between amount of ordering message and incoming liquidity transfer from T2S)

2 User Guide for Payments Module (PM)

- 2.9 Interconnection with TARGET2 Securities
- 2.9.3 Flow of Liquidity Transfers

2.9.3.3.1 Initiation via XML message

Flow of liquidity transfer from T2S initiated in TARGET2 “pull liquidity” via XML message - case: positive Receipt from T2S

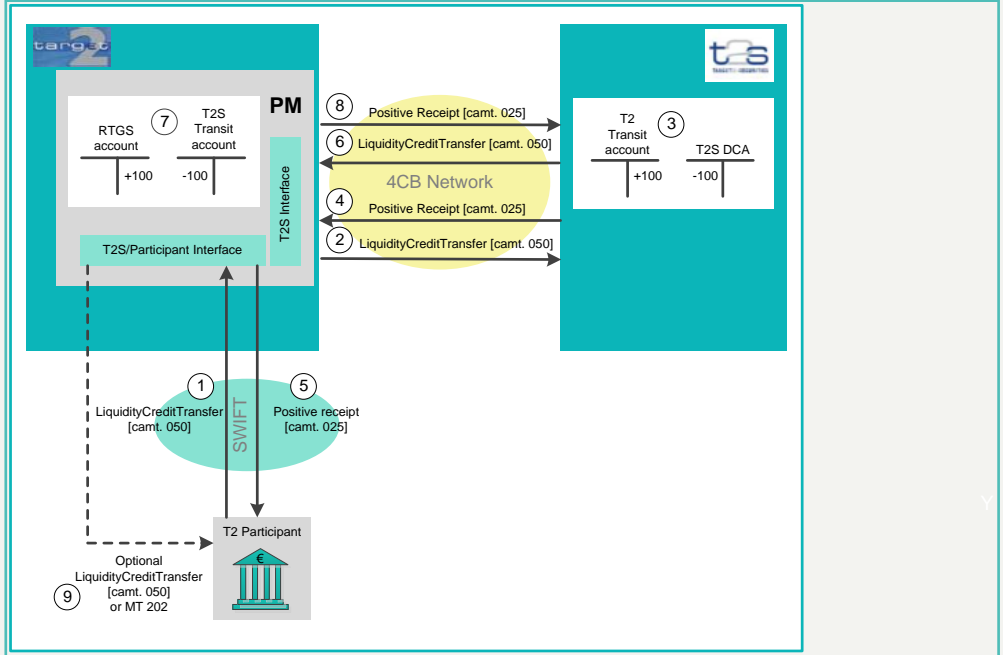

Step	Processing in/between	Description
1	TARGET2 part. → TARGET2	A TARGET2 participant sends a LiquidityCreditTransfer for the initiation of a liquidity transfer from T2S to TARGET2 pull liquidity via SWIFT. The TARGET2 direct participant can specify only a DCA number to be debited which is linked to his RTGS account. The account to be credited can be any RTGS account in TARGET2 (except AS-related and technical ones). Note: The sending DN is the DN matching the participant BIC in the DN-BIC matching table.
2	TARGET2 → T2S	After successful validation TARGET2 sends a LiquidityCredit-

2 User Guide for Payments Module (PM)

2.9 Interconnection with TARGET2 Securities

2.9.3 Flow of Liquidity Transfers

Step	Processing in/between	Description
		Transfer with BAH on behalf of the TARGET2 participant to T2S via the 4CB network.
3	T2S	The liquidity transfer is validated. In case of successful validation the liquidity transfer is fully or partially (see note) executed: The specified DCA is debited and the TARGET2 transit account is credited. Note: In case of partial execution in T2S the amount of the initiating message (step 1) and of the LiquidityCreditTransfer or MT 202 received by the TARGET2 participant from TARGET2 (step 9) is different.
4	T2S → TARGET2	A Receipt is sent to TARGET2 indicating the successful execution in T2S.
5	TARGET2 → TARGET2 part.	TARGET2 sends a positive Receipt to the TARGET2 participant via SWIFT. Note: The receiving DN is the DN of the business case initiator (sender of the LiquidityCreditTransfer - see step 1).
6	T2S → TARGET2	A LiquidityCreditTransfer is sent from T2S to TARGET2 via the 4CB network.
7 - 9	TARGET2	Further processing of the incoming liquidity transfer from T2S as a new and independent business case in TARGET2.

2 User Guide for Payments Module (PM)

2.9 Interconnection with TARGET2 Securities

2.9.3 Flow of LiquidityTransfers

Step	Processing in/between	Description
7	TARGET2	The liquiditytransfer is validated. In case of successful validation the T2S transit account is debited and the RTGS account of the TARGET2 participant specified in the liquiditytransfer is credited.
8	TARGET2 → T2S	TARGET2 sends a positive Receipt to T2S via the 4CB network.
9	TARGET2 → TARGET2 part.	As the incoming LiquidityCreditTransfer (step 6) will be processed as a new and independent business case (independent from the initial message in step 1), TARGET2 sends a LiquidityCreditTransfer or an MT 202 on an optional basis depending on the flag for T2S related push messages (stored in SD) to the TARGET2 participant via SWIFT. Note: In case of LiquidityCreditTransfer: The receiving DN is the DN stored in SD for this service.

2 User Guide for Payments Module (PM)

2.9 Interconnection with TARGET2 Securities

2.9.3 Flow of Liquidity Transfers

Flow of liquidity transfer from T2S initiated in TARGET2 “pull liquidity“ via XML message - case: negative Receipt from T2S

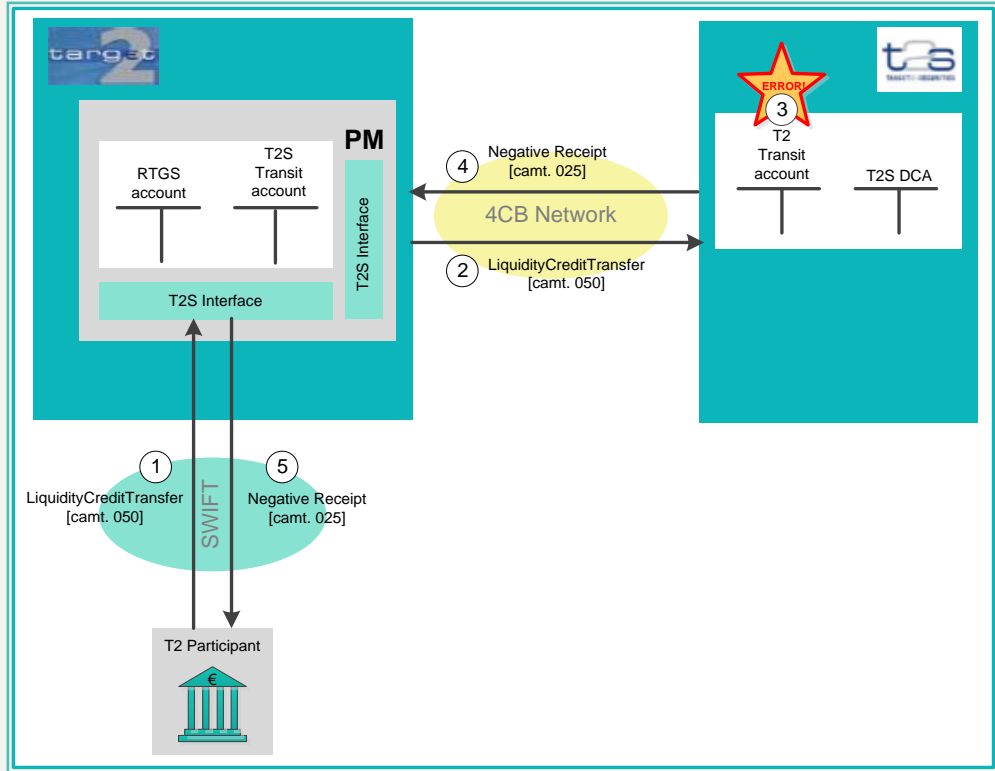

Step	Processing in/between	Description
1	TARGET2 part. → TARGET2	A TARGET2 participant sends a LiquidityCreditTransfer for the initiation of a liquidity transfer from T2S to TARGET2 pull liquidity via SWIFT. The TARGET2 direct participant can specify only a DCA number to be debited which is linked to his RTGS account. Note: The sending DN is the DN matching the participant BIC in the DN-BIC matching table.
2	TARGET2 → TS2	After successful validation TARGET2 sends a Liquidity-

2 User Guide for Payments Module (PM)

2.9 Interconnection with TARGET2 Securities

2.9.3 Flow of Liquidity Transfers

Step	Processing in/between	Description
		CreditTransfer with BAH on behalf of the TARGET2 participant to T2S via the 4CB network.
3	T2S	The liquiditytransfer is validated with error or can not be settled (eg balance of DCA is 0).
4	T2S → TARGET2	A negative Receipt is sent to TARGET2 indicating the unsuccessful execution/rejection in T2S.
5	TARGET2 → TARGET2 part.	TARGET2 sends a negative Receipt including the first error code reported by T2S (meaning can be checked with the T2S UDFS) or the unsettled status to the TARGET2 participant via SWIFT. Note: The receiving DN is the DN of the business case initiator (sender of the LiquidityCreditTransfer - see step 1).

2 User Guide for Payments Module (PM)

- 2.9 Interconnection with TARGET2 Securities
- 2.9.3 Flow of LiquidityTransfers

2.9.3.3.2 Initiation via MT message

Flow of liquidity transfer from T2S initiated in TARGET2 (“pull liquidity“) via MT message - case: positive Receipt from T2S

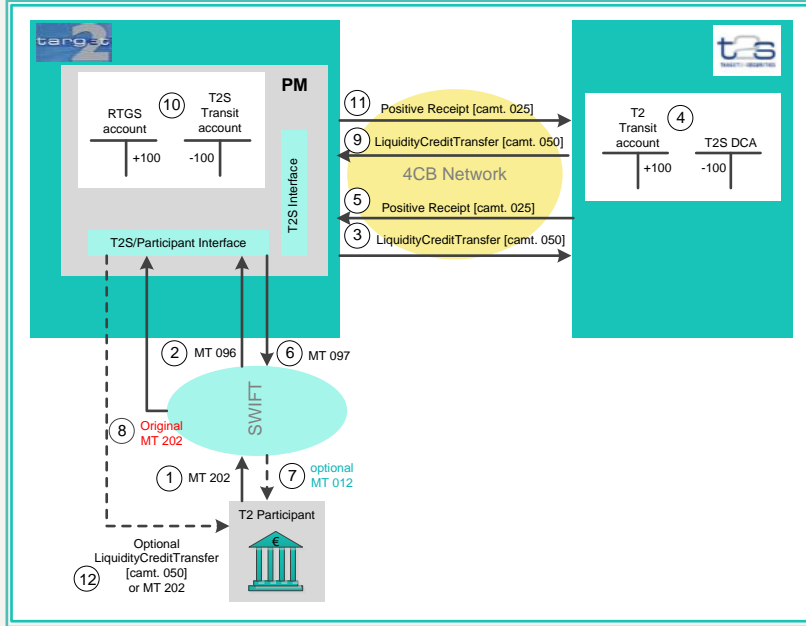

Step	Processing in/between	Description
1	TARGET2 part. → SWIFT	A TARGET2 participant initiates a liquidity transfer from T2S to TARGET2 via MT 202. The receiver BIC in the message header is the dedicated technical T2S BIC in TARGET2, TRGTXPMT2S. The TARGET2 participant can specify only a DCA number to be debited which is linked to his RTGS account. The account to be credited can be any RTGS account in TARGET2 (except AS-related and technical ones).
2	SWIFT → TARGET2	SWIFT sends a copy (MT 096) of the message to TARGET2.
3	TARGET2 → T2S	After successful validation the MT 202 (MT 096) is converted

2 User Guide for Payments Module (PM)

2.9 Interconnection with TARGET2 Securities

2.9.3 Flow of Liquidity Transfers

Step	Processing in/between	Description
		into a LiquidityCreditTransfer with BAH which is sent on behalf of the TARGET2 participant to T2S via the 4CB network.
4	T2S	The liquiditytransfer is validated. In case of successful validation the liquiditytransfer is fully or partially (see note) executed: The specified DCA is debited and the TARGET2 transit account is credited. Note: In case of partial execution in T2S the amount of the initiating message (step 1) and of the LiquidityCreditTransfer or MT 202 received by the TARGET2 participant from TARGET2 (step 12) is different.
5	T2S → TARGET2	A Receipt is sent to TARGET2 indicating the successful execution in T2S.
6	TARGET2 → SWIFT	TARGET2 sends the positive notification MT 097 to SWIFT.
7	SWIFT → TARGET2 part.	SWIFT sends an MT 012 on optional basis to the TARGET2 participant.
8	SWIFT → TARGET2	The original MT 202 is forwarded to TARGET2 for business case assignment.
9	T2S → TARGET2	A LiquidityCreditTransfer is sent from T2S to TARGET2 via the 4CB network.
10-12	TARGET2	Further processing of the incoming liquiditytransfer from T2S as a new and independent business case in TARGET2.

2 User Guide for Payments Module (PM)

- 2.9 Interconnection with TARGET2 Securities
- 2.9.3 Flow of Liquidity Transfers

Step	Processing in/between	Description
10	TARGET2	The liquidity transfer is validated. In case of successful validation the T2S transit account is debited and the RTGS account of the TARGET2 participant specified in the liquidity transfer is credited.
11	TARGET2 → T2S	TARGET2 sends a positive Receipt to T2S via the 4CB network.
12	TARGET2 → TARGET2 part.	As the incoming LiquidityCreditTransfer (step 9) will be processed as a new and independent business case (independent from the initial message in step 1), TARGET2 sends a LiquidityCreditTransfer or an MT 202 on an optional basis depending on the flag for T2S related push messages stored in SD to the TARGET2 participant via SWIFT. Note: In case of LiquidityCreditTransfer: The receiving DN is the DN stored in SD for this service.

Flow of liquidity transfer from T2S initiated in TARGET2 (“pull liquidity”) via MT message - case: negative Receipt from T2S

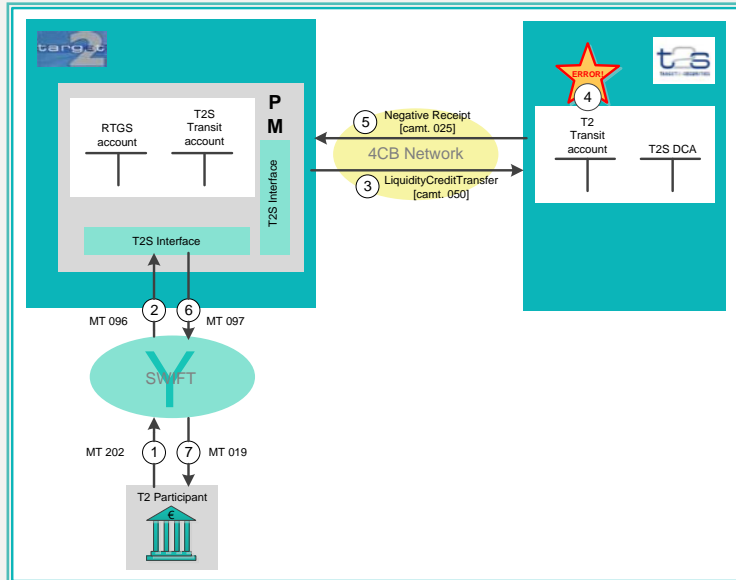

2 User Guide for Payments Module (PM)

2.9 Interconnection with TARGET2 Securities

2.9.3 Flow of Liquidity Transfers

Step	Processing in/between	Description
1	TARGET2 part. → SWIFT	A TARGET2 participant initiates a liquidity transfer from T2S to TARGET2 via MT 202. The receiver BIC in the message header is the dedicated technical T2S BIC in TARGET2, TRGTXEPMT2S. The TARGET2 participant can specify only a DCA number to be debited which is linked to his RTGS account.
2	SWIFT → TARGET2	SWIFT sends a copy (MT 096) of the message to TARGET2.
3	TARGET2 → T2S	After successful validation the MT 02 (MT 096) is converted into a LiquidityCreditTransfer with BAH which is sent on behalf of the TARGET2 participant to T2S via the 4CB network.
4	T2S	The liquidity transfer is validated with error or can not be settled (eg balance of DCA is 0).
5	T2S → TARGET2	A negative Receipt is sent to TARGET2 indicating the unsuccessful execution/rejection in T2S.
6	TARGET2 → SWIFT	TARGET2 sends the negative notification MT 097 to SWIFT.
7	SWIFT → TARGET2 part.	SWIFT sends an MT 019 to the TARGET2 participant. Note: Due to the limitation of the MT message format it is not possible to report the precise T2S error code. The contained TARGET2 Y-copy error code just indicates that the liquidity transfer was rejected by T2S. The precise T2S error code is reported in ICM and can be checked with the T2S UDFS.

2 User Guide for Payments Module (PM)

- 2.9 Interconnection with TARGET2 Securities
- 2.9.3 Flow of LiquidityTransfers

2.9.3.3.3 Initiation via ICM

Flow of liquidity transfer from T2S initiated in TARGET2 (“pull liquidity”) via ICM (U2A)

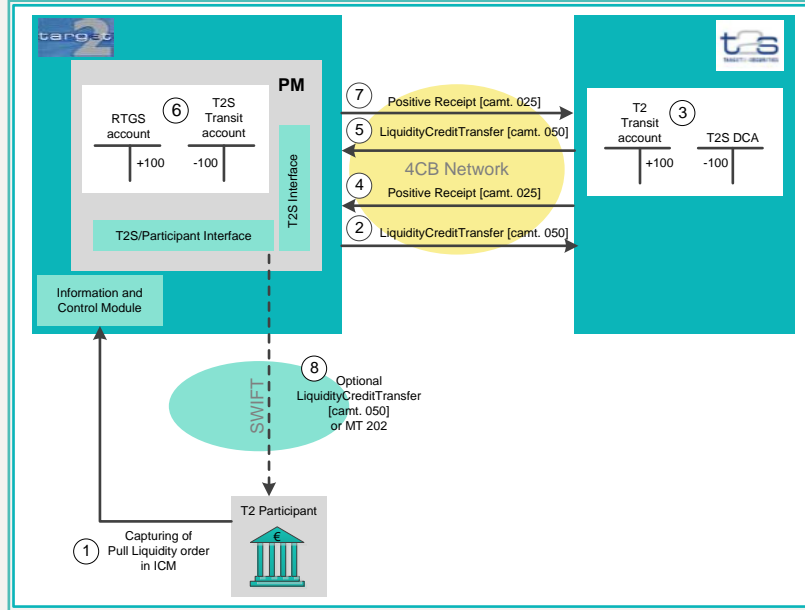

Step	Processing in/between	Description
1	TARGET2 part. → TARGET2	A TARGET2 direct participant initiates a liquidity transfer from T2S to TARGET2 (pull liquidity) via TARGET2 ICM. The direct participant can select only a DCA number to be debited which is linked to his RTGS account. The account to be credited can be any RTGS account in TARGET2 (except AS-related and technical ones). Note: The sending DN is the DN matching the participant BIC in the DN-BIC matching table.
2	TARGET2 → T2S	After successful validation TARGET2 sends a LiquidityCreditTransfer with BAH on behalf of the TARGET2 participant to T2S via the 4CB network.

2 User Guide for Payments Module (PM)

2.9 Interconnection with TARGET2 Securities

2.9.3 Flow of Liquidity Transfers

Step	Processing in/between	Description
3	T2S	The liquidity transfer is validated. In case of successful validation the liquidity transfer is fully or partially (see note) executed: The specified DCA is debited and the TARGET2 transit account is credited. Note: In case of partial execution in T2S the amount of the initiating message (step 1) and of the LiquidityCreditTransfer or MT 202 received by the direct participant from TARGET2 (step 8) is different.
4	T2S → TARGET2	A Receipt is sent to TARGET2 indicating the successful execution in T2S.
5	T2S → TARGET2	A LiquidityCreditTransfer is sent from T2S to TARGET2 via the 4CB network.
6-8	TARGET2	Further processing of the incoming liquidity transfer from T2S as a new and independent business case in TARGET2.
6	TARGET2	The liquidity transfer is validated. In case of successful validation the T2S transit account is debited and the RTGS account of the TARGET2 participant specified in the liquidity transfer is credited.
7	TARGET2 → T2S	TARGET2 sends a positive Receipt to T2S via the 4CB network.
8	TARGET2 → TARGET2 part.	As the incoming LiquidityCreditTransfer (step 6) will be processed as a new and independent business case (independent from the initial message in step 1), TARGET2 sends a LiquidityCreditTransfer or an MT 202 on an optional basis depending on the flag for T2S related push messages stored in SD to the TARGET2 participant via SWIFT. Note: In case of LiquidityCreditTransfer: The receiving DN is the DN stored in SD for this service.

2.9.4 Contingency measures

Scenarios

Contingency measures for TARGET2 participants performing liquidity transfers from TARGET2 to T2S might be needed in case of:

1. unavailability of TARGET2 as a whole
2. unavailability of a TARGET2 participant or its communication infrastructure with TARGET2
3. regional SWIFT outage

First scenario - unavailability of the whole TARGET2

For the first scenario - unavailability of the whole TARGET2 - the tool which is available is the Enhanced Contingency Solution (ECONS I). This module can be used for a number of consecutive days (up to 5) with the possibility of closing the business day and processing critical and very critical payments. Liquidity transfers to T2S can be classified as very critical payments.

The Enhanced Contingency Solution does not offer an own ECONS I-T2S interface for sending LiquidityCreditTransfer to T2S. Therefore the settlement in the TARGET2 ECONS I will be done on the ECONS I accounts (Participant and T2S transit account) without outgoing messages to T2S. The settlement on T2S side will be managed by operational procedures (i.e. manual booking).

For further information on the Enhanced Contingency Solution see chapter [4 User Guide for Enhanced Contingency Solution \(ECONS I\)](#), page 345 and chapter [8 Enhanced Contingency Solution \(ECONS I\) - User Handbook](#), page 406.

Second scenario - unavailability of a TARGET2 participant or its communication infrastructure with TARGET2

In the second scenario - unavailability of a TARGET2 participant or its communication infrastructure with TARGET2 - specific contingency measures are provided by TARGET2 for certain actors, these are:

- responsible CB acting on behalf of the affected TARGET2 participant initiating a liquidity transfer to T2S (“push”) via XML message (A2A) or via ICM (U2A)
- responsible CB initiating on behalf of the affected TARGET2 participant a liquidity transfer to T2S (“push”) via a mandated payment MT 202

2.10 Interconnection with TIPS

2.10.1 TIPS Interface (TIPSI)

- T2S Actor in TARGET2 (eg CSD) working as the affected TARGET2 participant initiating a liquidity transfer to T2S (“push”) via XML message (A2A).

Third scenario - regional SWIFT outage

In the third scenario - regional SWIFT outage - CBs and the SSP OT have access to the PAPSS via the Eurosystem's CoreNet contingency network (see chapter [5.3 Contingency Network, page 360](#)).

TARGET2 participants unable to access the PAPSS have to transmit via contingency means (agreed at national level) their instructions to their CB. Via CoreNet contingency network the CB (or SSP OT) is able to act on behalf of the affected TARGET2 participant initiating a liquidity transfer to T2S (“push”) in ICM (U2A).

2.10 Interconnection with TIPS

Overview

TARGET Instant Payment Settlement (TIPS) is a harmonised and standardised pan-European service with common functionality across different countries and jurisdictions for settling payments instantly in Central Bank Money, with high capacity and around-the-clock availability.

The primary aim of TIPS is to offer instant settlement services in euro to its participants, extending the services offered by TARGET2.

The interconnection between TARGET2 and TIPS is based on an application-to-application approach. The TARGET2 interconnection to TIPS facilitates mainly the provision of euro denominated liquidity transfers from TARGET2 RTGS accounts to TIPS Accounts and vice versa during the TARGET2 business day.

2.10.1 TIPS Interface (TIPSI)

Dedicated Interface

The connection of TIPS to TARGET2 is considered and built as a new dedicated interface specially designed for TIPS, called TIPS interface (TIPSI).

2 User Guide for Payments Module (PM)

2.10 Interconnection with TIPS

2.10.1 TIPS Interface (TIPSI)

System-to-system connectivity

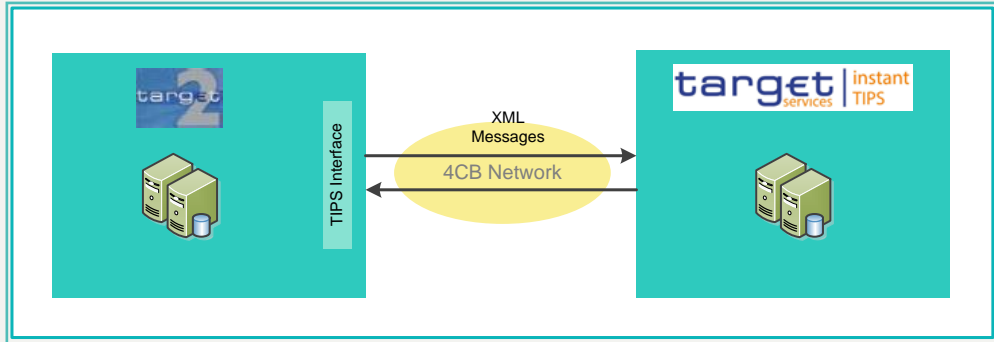

The system-to-system connection between TARGET2 and TIPS is based on the internal 4CB network and uses the same XML message standard as required by the TIPS specifications.

System-to-user connectivity

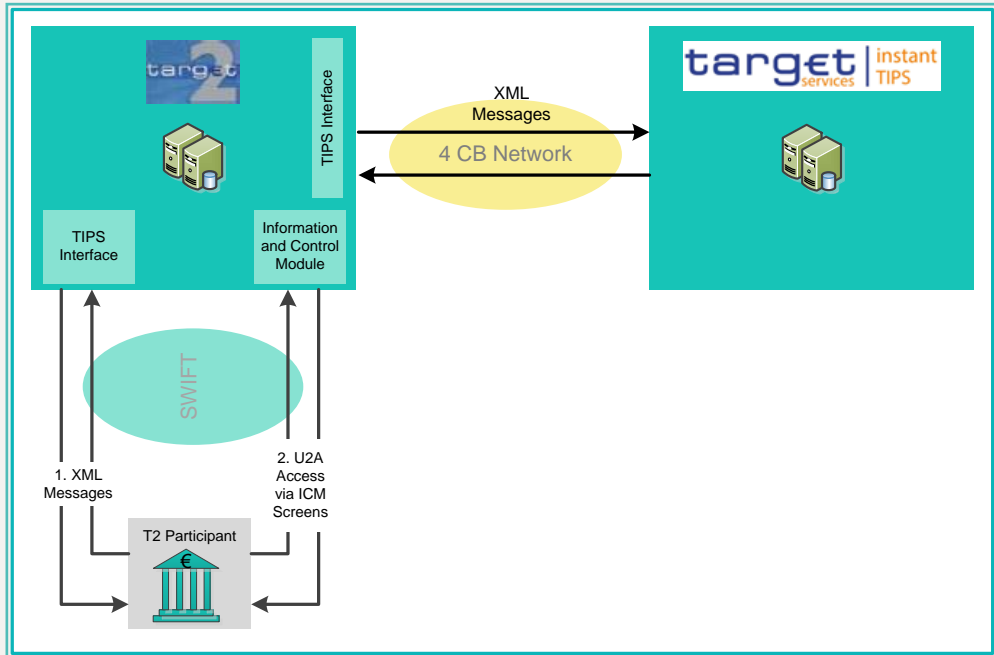

2.10	Interconnection with TIPS
2.10.2	Overview of provided services

A direct participant will have two interfaces to TARGET2 to instruct TIPS related business cases:

1. A2A (XML messages) via the TIPS interface
2. U2A via the Information and Control Module.

The connection between TARGET2 and the direct participants is based on the SWIFT network.

The message standard used for the TIPS-related A2A XML message exchange between the direct participant and TARGET2 in both directions will always be the same message standard as used for the interconnection with TIPS.

2.10.2 Overview of provided services

The following table provides an overview of the services provided by TARGET2 related to TIPS business:

Service	ICM/U2A	A2A (TIPS XML standard)
Current order liquidity transfer "push" to TIPS	x	x
Current order liquidity transfer "pull" from TIPS	x	x
Standing order liquidity transfer "push" to TIPS (set up in SD)	x	x
Debit notification for liquidity transfer "push" on RTGS	x*	x
Information on incoming liquidity transfer from TIPS	x*	x
Intraday balance	x	x
TIPS account closing balance	x	

* via standard payments monitoring

Core Services

2.10.2.1 Core services

Standing order liquidity transfer (“push“)

A standing order liquidity transfer is an automatically executed instruction of a fixed amount of liquidity from the RTGS account of the direct participant to any euro denominated account in TIPS. The standing order liquidity transfers can be captured directly via ICM in U2A mode or via XML message in A2A mode by the RTGS account holder or its responsible CB. The details captured in the Static Data Module before the start of the end-of-day processing will become active on the next business day (earliest activation date). The same principle applies for standing order modifications. The processing of the standing order liquidity transfers - outgoing messages and incoming confirmations - can be monitored via ICM.

Current order liquidity transfer (“push“)

A current order liquidity transfer to TIPS is an immediate transfer of liquidity from the RTGS account of a direct participant to any euro denominated TIPS account. It can be initiated by the RTGS account holder, its responsible CB or the group of accounts (GoA) manager to which the RTGS account belongs. The current order liquidity transfer can be submitted via ICM (U2A) or via XML message in the standard supported by TIPS. Current order liquidity transfers are executed by start of the new business day from 19.30 (interrupted by the maintenance window from 22.00 to 01.00) and during the TARGET2 day trade phase till the cut-off for bank to bank payments (18.00). The processing of the current order liquidity transfers - outgoing messages and incoming confirmations - can be monitored during the processing times via ICM.

Debit notification for standing and current order liquidity transfers

For the execution of the following liquidity transfers from RTGS account to any euro denominated accounts in TIPS a notification via XML message BanktoCustomerDebitNotification can be provided to the direct participant on an optional basis:

- Standing order liquidity transfers
- Current order liquidity transfer initiated in ICM (U2A)
- Current order liquidity transfer initiated by authorised other third parties (CB or GoA manager on behalf)

The flag for the selected notification is stored in Static Data.

2.10	Interconnection with TIPS
2.10.2	Overview of provided services

Incoming liquidity transfer from TIPS

Incoming liquidity transfers from TIPS are processed in TARGET2 at any time excluding the end-of-day and start-of-day processing (from 18.00 to 19.30) and the technical maintenance window (from 22.00 to 01.00).

2.10.2.2 “Pull” Liquidity from TIPS

Current order liquidity transfer from TIPS account to RTGS account (“pull“)

This service offers the possibility to submit current order liquidity transfers from a euro denominated account in TIPS (linked to the initiating direct TARGET2 participant) to any RTGS account in TARGET2. It can be initiated by a direct participant or its responsible CB in TARGET2 via:

- XML LiquidityCreditTransfer message
- Directly in ICM (U2A)

The TIPS response is an incoming current order liquidity transfer which is processed in TARGET2 as a new independent business case. The time constraints for the processing of “pull“ current order liquidity transfers are the same as for the “push“ current orders.

TIPS account intraday balance

The TARGET2 direct participants can monitor the balances of up to ten the TIPS accounts linked to their RTGS accounts directly in ICM (U2A) or request the DCA balance via XML message (A2A).

The liquidity view on the RTGS and its related TIPS account balances are displayed in the same ICM screen which enables the direct participants, their responsible CB or the GoA manager on behalf to monitor the liquidity position in both systems.

TIPS account closing balance

The TARGET2 direct participants can additionally check the TIPS account closings balances via U2A. The screen will show an overview of the EoD balances of all the TIPS accounts connected to the RTGS account via the LM link with the related business date of the provided balances. Furthermore the sum of all shown TIPS EoD balances will be shown in a total value (generated from the last available General Ledger Information from TIPS). If no information is provided by the GL from TIPS the values will remain unchanged until new updated information is available.

2.10.3 Flow of Liquidity Transfers

Basics

The main services of the interconnection with TIPS are the execution of euro denominated liquidity transfers from TARGET2 RTGS accounts to TIPS accounts and vice versa.

Transit account

For the settlement of liquidity transfers between TARGET2 and TIPS an off-set account in each system is used. In TARGET2 this offset account is called TIPS transit account.

The following chapter gives an overview of the flow of messages between the direct participant and TARGET2 as well as between TARGET2 and TIPS.

Note: The flows are always referring to a successful processing on TARGET2 and TIPS side.

2.10.3.1 Push Liquidity to TIPS

Basics

All direct participants with an RTGS account can transfer liquidity to any euro denominated account in TIPS. This is valid for current as well as for standing orders.

The TIPS accounts, which will be credited in TIPS, are not validated by TARGET2. In case of a rejection by TIPS (eg because of unknown account number or account related to another currency) the liquidity transfer is automatically “unwinded” via a reversal booking in favour of the RTGS account of the initiating TARGET2 participant.

2.10.3.1.1 Standing orders

Main attributes

Processing time in TARGET2	Event-executed at the beginning of the phase “Settlement of AS night-time processing” (19.30). Note: The phase “Settlement of AS night-time processing” starts fifteen minutes later on the last day of the minimum reserve period.
Priority in PM	highly urgent
Consequences in case of lack of funds	Pro rata execution of all standing orders executed at the execution event (ie together with the ASI and T2S standing orders).
Consequences in case of excluded sending participant in TARGET2	No liquidity transfer will be triggered. Current orders have to be used instead.

2 User Guide for Payments Module (PM)

- 2.10 Interconnection with TIPS
- 2.10.3 Flow of Liquidity Transfers

Flow of standing order liquidity transfer to TIPS

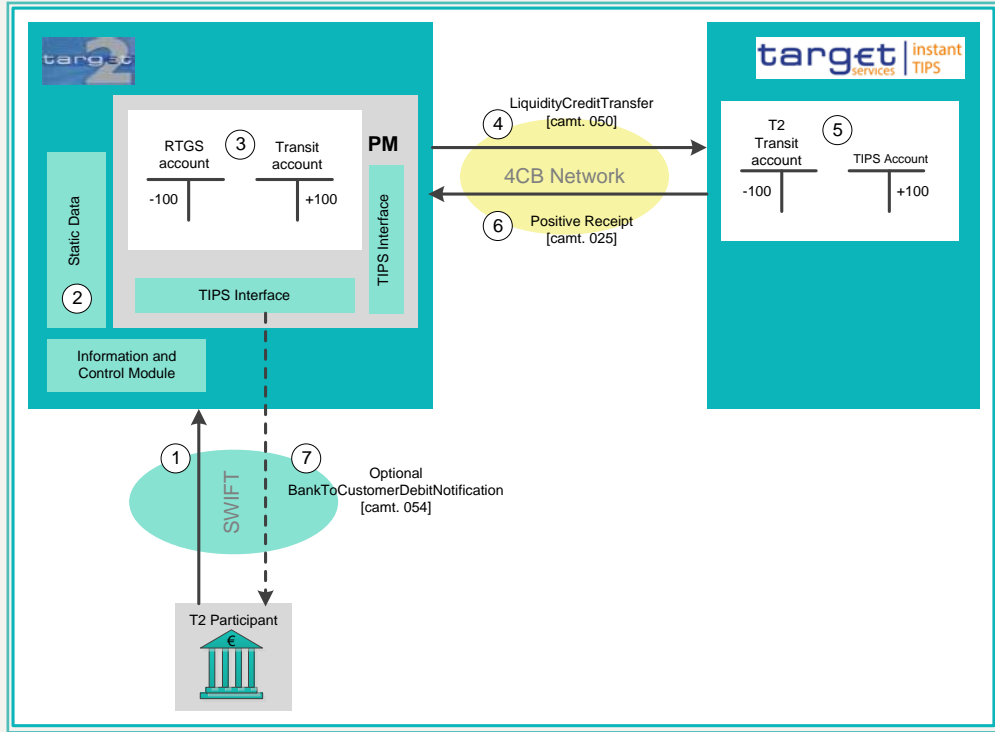

Step	Processing in/between	Description
1	TARGET2 part → TARGET2	The TARGET2 participant captures a standing order liquidity transfer from TARGET2 to TIPS via ICM.
2	TARGET2	The standing order is stored in TARGET2 SD and forwarded to PM from its activation date via SD loading. Note: The activation date for standing orders is always D+1 in SD.
3	TARGET2	When the phase "Settlement of AS night-time processing" is started the standing orders are executed by debiting the RTGS account of the ordering TARGET2 participant and crediting the

2 User Guide for Payments Module (PM)

- 2.10 Interconnection with TIPS
- 2.10.3 Flow of Liquidity Transfers

Step	Processing in/between	Description
		TIPS transit account.
4	TARGET2 → TIPS	A LiquidityCreditTransfer is sent from TARGET2 to TIPS via the 4CB network.
5	TIPS	The liquidity transfer is validated. In case of successful validation the TARGET2 transit account is debited and the account specified in the liquidity transfer is credited.
6	TIPS → TARGET2	TIPS sends a positive Receipt to TARGET2 via the 4CB network.
7	TARGET2 → TARGET2 part.	TARGET2 sends an optional BankToCustomerDebitNotification to the TARGET2 direct participant via SWIFT. Note: In case of BankToCustomerDebitNotification; The receiving DN is the DN stored in SD for this notification service. In case the Receipt from TIPS in step 6 is negative (due to rejection on TIPS side), no optional BankToCustomerDebitNotification is sent to the TARGET2 participant after the reversal booking.

2.10.3.1.2 Current orders by account owner

2.10.3.1.2.1 Initiation via XML message

Main attributes

Processing time in TARGET2	From start of phase “Settlement of AS night-time processing” till the dedicated Cut-off for bank-to-bank transfers (19.30 - 18.00) except TARGET2 maintenance window (22.00 - 01.00). Messages received after Cut-off for Message Input (currently 18.30) are stored (not visible in ICM) for the later processing. Note: The phase “Settlement of AS night-time processing” starts fifteen minutes later on the last day of the minimum reserve period.
Warehouse functionality	no
Consequences in case of lack of funds	Daylight phases (07.00 - 18.00): Queuing Night-time phases (19.30 - 07.00): Rejection
Consequences in case of highly urgent payments submitted earlier and already pending in queue	Daylight phases (07.00 - 18.00): Queuing Night-time phases (19.30 - 07.00): Rejection

2 User Guide for Payments Module (PM)

- 2.10 Interconnection with TIPS
- 2.10.3 Flow of Liquidity Transfers

Flow of current order liquidity transfer to TIPS initiated via XML message - case: positive Receipt from TIPS.

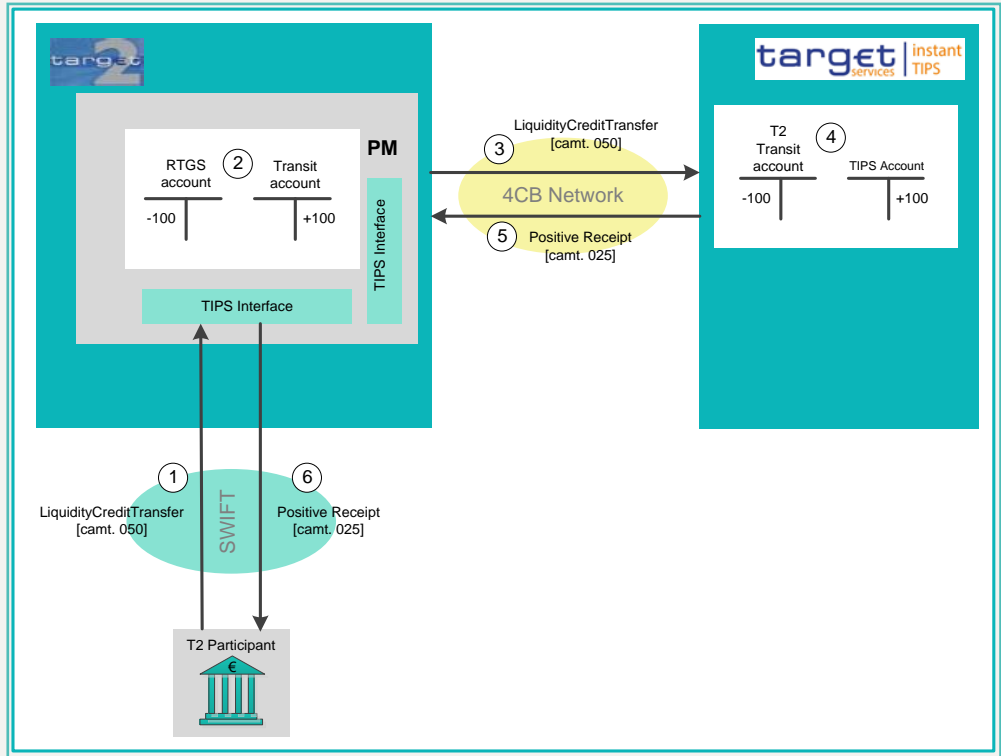

Step	Processing in/between	Description
1	TARGET2 part. → TARGET2	The TARGET2 participant sends a LiquidityCreditTransfer for the initiation of a liquiditytransfer from TARGET2 to TIPS via SWIFT. Note: The sending DN is the DN matching the participant BIC in the DN-BIC matching table.
2	TARGET2	The liquiditytransfer is validated. In case of successful validation the RTGS account of the ordering TARGET2 participant is debited and the TIPS transit account is credited.

2 User Guide for Payments Module (PM)

2.10 Interconnection with TIPS

2.10.3 Flow of Liquidity Transfers

Step	Processing in/between	Description
3	TARGET2 → TIPS	A LiquidityCreditTransfer is sent from TARGET2 to TIPS via the 4CB network.
4	TIPS	The liquidity transfer is validated. In case of successful validation the T2 Transit account is debited and the account specified in the liquidity transfer is credited.
5	TIPS → TARGET2	TIPS sends a positive Receipt to TARGET2 via the 4CB network.
6	TARGET2 → TARGET2 part	TARGET2 sends a positive Receipt to the TARGET2 participant via SWIFT. Note: The receiving DN is the DN of the business case initiator (sender of the LiquidityCreditTransfer - see step 1).

2 User Guide for Payments Module (PM)

- 2.10 Interconnection with TIPS
- 2.10.3 Flow of Liquidity Transfers

Flow of current order liquidity transfer to TIPS initiated via XML message - case: negative Receipt from TIPS

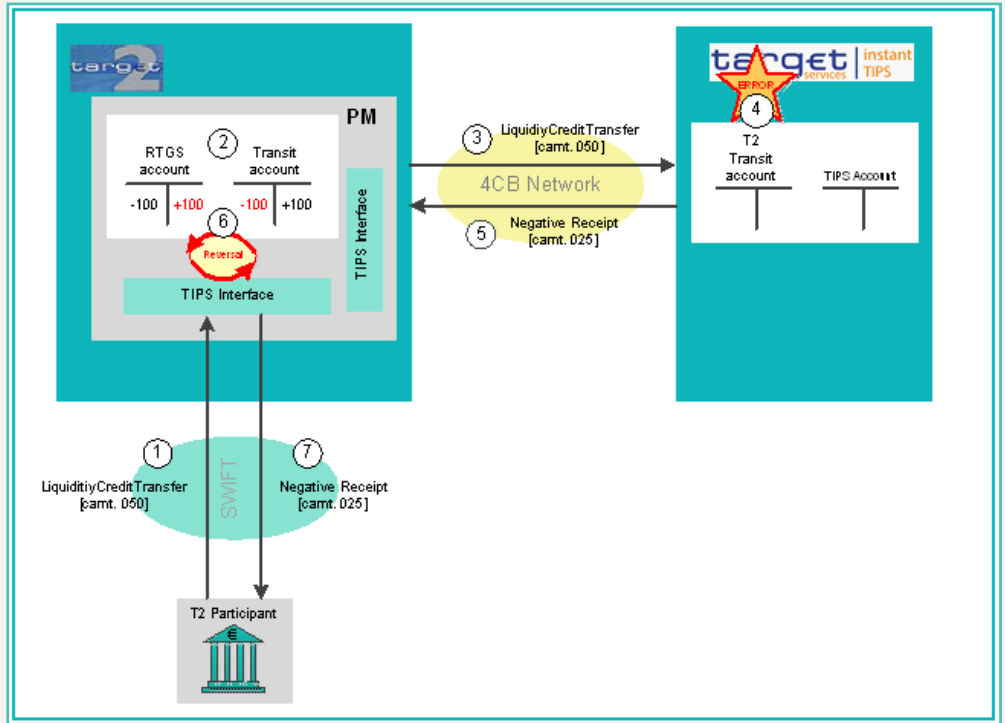

Step	Processing in/between	Description
1	TARGET2 part. → TARGET2	The TARGET2 participant sends a LiquidityCreditTransfer for the initiation of a liquiditytransfer from TARGET2 to TIPS via SWIFT. Note: The sending DN is the DN matching the participant BIC in the DN-BIC matching table.
2	TARGET2	The liquiditytransfer is validated. In case of successful validation the RTGS account of the ordering TARGET2 participant is debited and the TIPS transit account is credited.
3	TARGET2 → TIPS	A LiquidityCreditTransfer is sent from TARGET2 to TIPS via the

2 User Guide for Payments Module (PM)

- 2.10 Interconnection with TIPS
- 2.10.3 Flow of Liquidity Transfers

Step	Processing in/between	Description
		4CB network.
4	TIPS	The liquidity transfer is validated with error (e.g. unknown creditor account). Due to the error the liquidity transfer is not settled in TIPS.
5	TIPS → TARGET2	TIPS sends a negative Receipt with the respective TIPS error code to TARGET2 via the 4CB network.
6	TARGET2	The booking of step 2 is automatically reversed, i.e. the TIPS transit account is debited and the RTGS account of the ordering TARGET2 participant is credited.
7	TARGET2 → TARGET2 part	TARGET2 sends a negative Receipt including the first error code reported by TIPS (meaning can be checked with the TIPS UDFS) to the TARGET2 participant via SWIFT. Note: The receiving DN is the DN of the business case initiator (sender of the LiquidityCreditTransfer - see step 1).

2.10.3.1.2.2 Initiation via ICM

Main attributes

Processing time in TARGET2	From start of phase "Settlement of AS night-time processing" till the dedicated Cut-off for bank-to-bank transfers (19.30 - 18.00) except TARGET2 maintenance window (22.00 - 01.00). Note: The phase "Settlement of AS night-time processing" starts fifteen minutes later on the last day of the minimum reserve period.
Priority in PM	highly urgent
Consequences in case of lack of funds	Daylight phases (07.00 - 18.00): Queuing Night-time phases (19.30 - 07.00): Rejection
Consequences in case of highly urgent payments submitted earlier	Daylight phases (07.00 - 18.00): Queuing Night-time phases (19.30 - 07.00): Rejection

2 User Guide for Payments Module (PM)

- 2.10 Interconnection with TIPS
- 2.10.3 Flow of Liquidity Transfers

and already pending in queue

Flow of current order liquidity transfer to TIPS initiated via ICM (U2A)

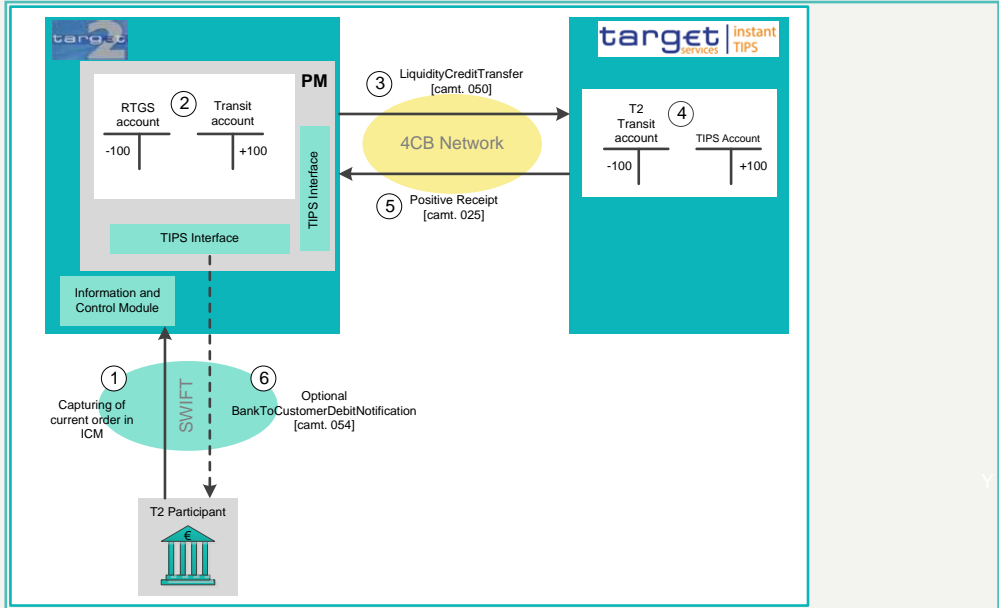

Step	Processing in/between	Description
1	TARGET2 part. → TARGET2	A direct participant initiates a liquidity transfer from TARGET2 to TIPS via TARGET2 ICM.
2	TARGET2	The liquidity transfer is validated. In case of successful validation the RTGS account of the ordering TARGET2 participant is debited and the TIPS transit account is credited.
3	TARGET2 → TIPS	A LiquidityCreditTransfer is sent from TARGET2 to TIPS via the 4CB network.

2 User Guide for Payments Module (PM)

- 2.10 Interconnection with TIPS
- 2.10.3 Flow of Liquidity Transfers

Step	Processing in/between	Description
4	TIPS	The liquidity transfer is validated. In case of successful validation the TARGET2 transit account is debited and the account specified in the liquidity transfer is credited.
5	TIPS → TARGET2	TIPS sends a positive Receipt to TARGET2 via the 4CB network.
6	TARGET2 → TARGET2 part.	TARGET2 sends an optional BankToCustomerDebitNotification to the TARGET2 participant via SWIFT. Note: In case of BankToCustomerDebitNotification: The receiving DN is the DN stored in SD for this notification service. In case the Receipt from TIPS in step 5 is negative (due to rejection on TIPS side), no optional BankToCustomerDebitNotification is sent to the TARGET2 participant after the reversal booking.

2.10.3.2 Incoming Liquidity Transfers from TIPS

Basics

A TIPS actor (dependent from the access rights defined in TIPS) can initiate an immediate Liquidity Transfer in TIPS to any RTGS account in TARGET2 (except AS-related and technical ones). The processing of the Liquidity Transfer message sent by TIPS is for all cases the same in TARGET2.

Main attributes

Processing time in TARGET2	From start of phase "Settlement of AS night-time processing" till last run of algorithm (19.30 – shortly after 18.00) except maintenance window (22.00 - 01.00). Note: The phase "Settlement of AS night-time processing" starts fifteen minutes later on the last day of the minimum reserve period.
Priority in PM	highly urgent

2 User Guide for Payments Module (PM)

- 2.10 Interconnection with TIPS
- 2.10.3 Flow of Liquidity Transfers

Flow of incoming liquidity transfers from TIPS

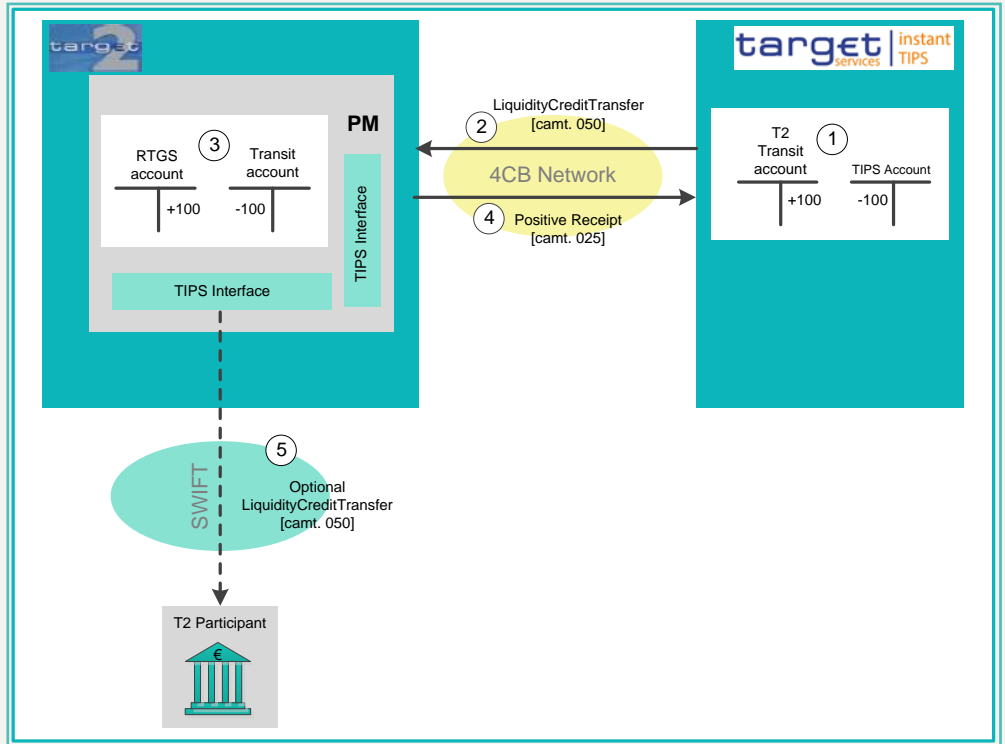

Step	Processing in/between	Description
1	TIPS	The liquidity transfer (outbound liquidity transfer) initiated on TIPS side is executed: The specified account is debited and the TARGET2 transit account is credited.
2	TIPS → TARGET2	A LiquidityCreditTransfer is sent from TIPS to TARGET2 via the 4CB network.

Step	Processing in/between	Description
3	TARGET2	The liquidity transfer is validated. In case of successful validation the TIPS transit account is debited and the RTGS account of the TARGET2 participant specified in the liquidity transfer is credited.
4	TARGET2 → TIPS	TARGET2 sends a positive Receipt to TIPS via the 4CB network.
5	TARGET2 → TARGET2 part.	TARGET2 sends an optional LiquidityCreditTransfer to the TARGET2 participant via SWIFT. Note: In case of LiquidityCreditTransfer: The receiving DN is the DN stored in SD for this service.

2.10.3.3 Pull Liquidity from TIPS

TIPS participants with RTGS account in TARGET2 will also have the possibility to initiate a Liquidity Transfer from the TIPS account linked to their RTGS account to any RTGS account in TARGET2 (except AS-related and technical ones) via XML message or via ICM. For this purpose TARGET2 will send the immediate liquidity transfer to TIPS on behalf of the direct participant and TIPS will generate an outbound liquidity transfer to TARGET2 via the 4CB network.

Basics

2 User Guide for Payments Module (PM)

- 2.10 Interconnection with TIPS
- 2.10.3 Flow of Liquidity Transfers

Main attributes

Processing time in TARGET2	<p>From start of phase “Settlement of AS night-time processing” till the dedicated cut-off time for bank-to-bank transfers (19.30 - 18.00) except TARGET2 maintenance window (22.00 - 01.00).</p> <p>For initiation via XML message the following rules apply:</p> <ul style="list-style-type: none">• Messages received after Cut-off for Message Input (18.30) are stored (not visible in ICM) for the later processing. <p>Initiation via ICM depends on the accessibility of the respective screens and is possible only within the above mentioned timeframe (19.30 - 18.00) except TARGET2 maintenance window (22.00 - 01.00).</p> <p>Note: The phase “Settlement of AS night-time processing” starts fifteen minutes later on the last day of the minimum reserve period.</p>
Warehouse functionality	no
Priority in PM	highly urgent
Consequences in case of lack of funds	Partial execution on TIPS side not possible, i.e. negative receipt is sent to TARGET2

2 User Guide for Payments Module (PM)

- 2.10 Interconnection with TIPS
- 2.10.3 Flow of Liquidity Transfers

2.10.3.3.1 Initiation via XML message

Flow of liquidity transfer from TIPS initiated in TARGET2 “pull liquidity“ via XML message - case: positive Receipt from TIPS

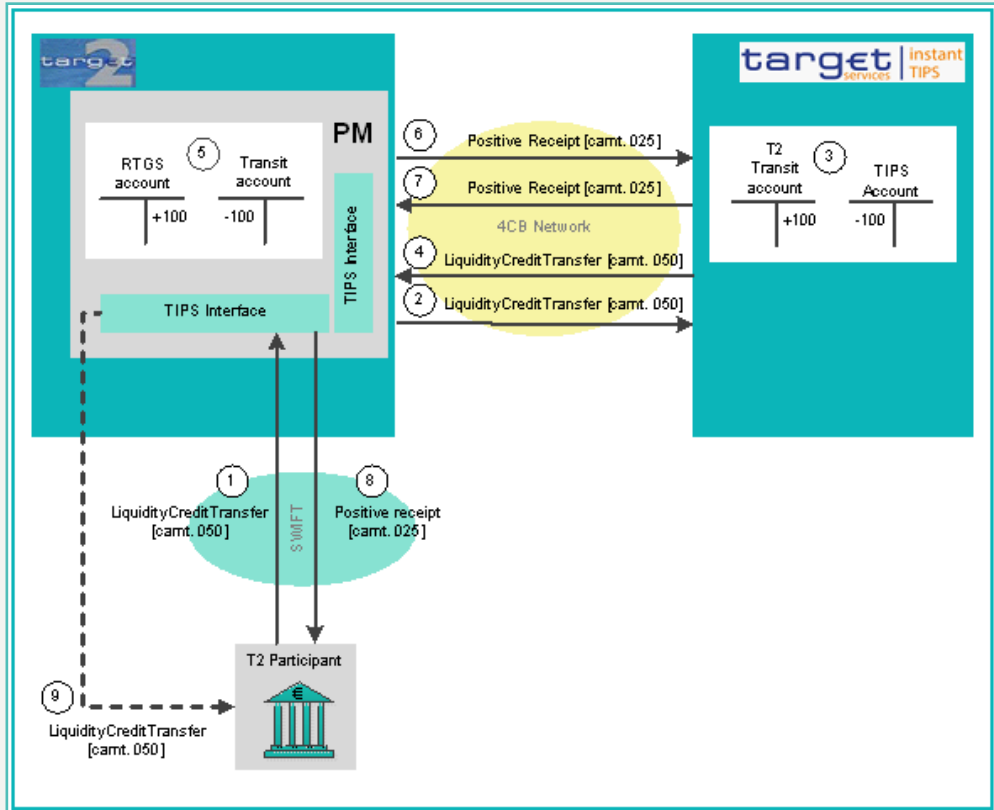

2 User Guide for Payments Module (PM)

- 2.10 Interconnection with TIPS
- 2.10.3 Flow of Liquidity Transfers

Step	Processing in/between	Description
1	TARGET2 part. → TARGET2	<p>A TARGET2 participant sends a LiquidityCreditTransfer for the initiation of a liquiditytransfer from TIPS to TARGET2 pull liquidity via SWIFT.</p> <p>The TARGET2 direct participant can specify only an account number to be debited which is linked to his RTGS account. The account to be credited can be any RTGS account in TARGET2 (except AS-related and technical ones).</p> <p>Note: The sending DN is the DN matching the participant BIC in the DN-BIC matching table.</p>
2	TARGET2 → TIPS	After successful validation TARGET2 sends a LiquidityCreditTransfer on behalf of the TARGET2 participant to TIPS via the 4CB network.
3	TIPS	The liquiditytransfer is validated. In case of successful validation the liquiditytransfer is executed: The specified account is debited and the TARGET2 transit account is credited.
4	TIPS → TARGET2	A LiquidityCreditTransfer is sent from TIPS to TARGET2 via the 4CB network.
5	TARGET2	The liquiditytransfer is validated. In case of successful validation the TIPS transit account is debited and the RTGS account of the TARGET2 participant specified in the liquidity transfer is credited.
6	TARGET2 → TIPS	TARGET2 sends a positive Receipt to TIPS via the 4CB network.

2 User Guide for Payments Module (PM)

- 2.10 Interconnection with TIPS
- 2.10.3 Flow of LiquidityTransfers

Step	Processing in/between	Description
7	TIPS → TARGET2	TIPS sends a positive Receipt to TARGET2 via the 4CB network.
8	TARGET2 → TARGET2 part.	TARGET2 sends a positive Receipt to the TARGET2 participant via SWIFT. Note: The receiving DN is the DN of the business case initiator (sender of the LiquidityCreditTransfer - see step 1).
9	TARGET2 → TARGET2 part.	As the incoming LiquidityCreditTransfer (step 4) will be processed as a new and independent business case (independent from the initial message in step 1), TARGET2 sends an optional LiquidityCreditTransfer to the TARGET2 participant via SWIFT. Note: In case of LiquidityCreditTransfer: The receiving DN is the DN stored in SD for this service.

2 User Guide for Payments Module (PM)

- 2.10 Interconnection with TIPS
- 2.10.3 Flow of Liquidity Transfers

Flow of liquidity transfer from TIPS initiated in TARGET2 “pull liquidity“ via XML message - case: negative Receipt from TIPS

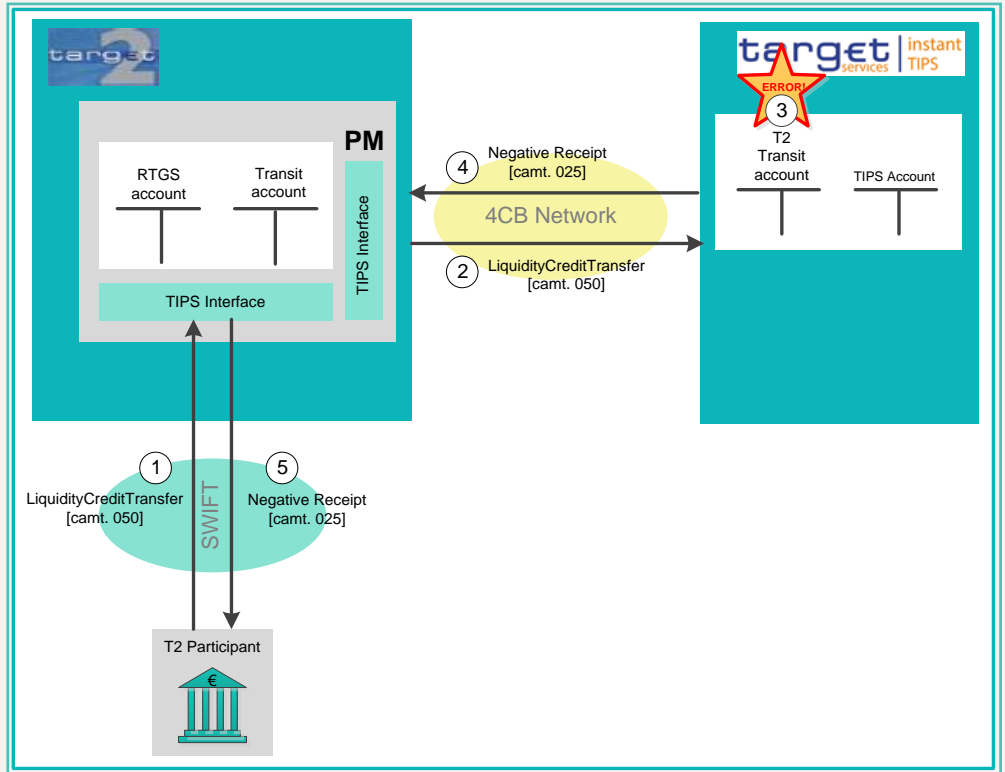

Step	Processing in/between	Description
1	TARGET2 part. → TARGET2	A TARGET2 participant sends a LiquidityCreditTransfer for the initiation of a liquidity transfer from TIPS to TARGET2 pull liquidity via SWIFT. The TARGET2 direct participant can specify only an account number to be debited which is linked to his RTGS account. Note: The sending DN is the DN matching the participant BIC in the DN-BIC matching table.
2	TARGET2 → TIPS	After successful validation TARGET2 sends a Liquidity-

2 User Guide for Payments Module (PM)

- 2.10 Interconnection with TIPS
- 2.10.3 Flow of Liquidity Transfers

Step	Processing in/between	Description
		CreditTransfer on behalf of the TARGET2 participant to TIPS via the 4CB network.
3	TIPS	The liquiditytransfer is validated with error or can not be settled (eg balance of account is not sufficient).
4	TIPS → TARGET2	A negative Receipt is sent to TARGET2 indicating the unsuccessful execution/rejection in TIPS.
5	TARGET2 → TARGET2 part.	TARGET2 sends a negative Receipt including the first error code reported by TIPS (meaning can be checked with the TIPS UDFS) or the unsettled status to the TARGET2 participant via SWIFT. Note: The receiving DN is the DN of the business case initiator (sender of the LiquidityCreditTransfer - see step 1).

2 User Guide for Payments Module (PM)

- 2.10 Interconnection with TIPS
- 2.10.3 Flow of Liquidity Transfers

2.10.3.3.2 Initiation via ICM

Flow of liquidity transfer from TIPS initiated in TARGET2 (“pull liquidity”) via ICM (U2A)

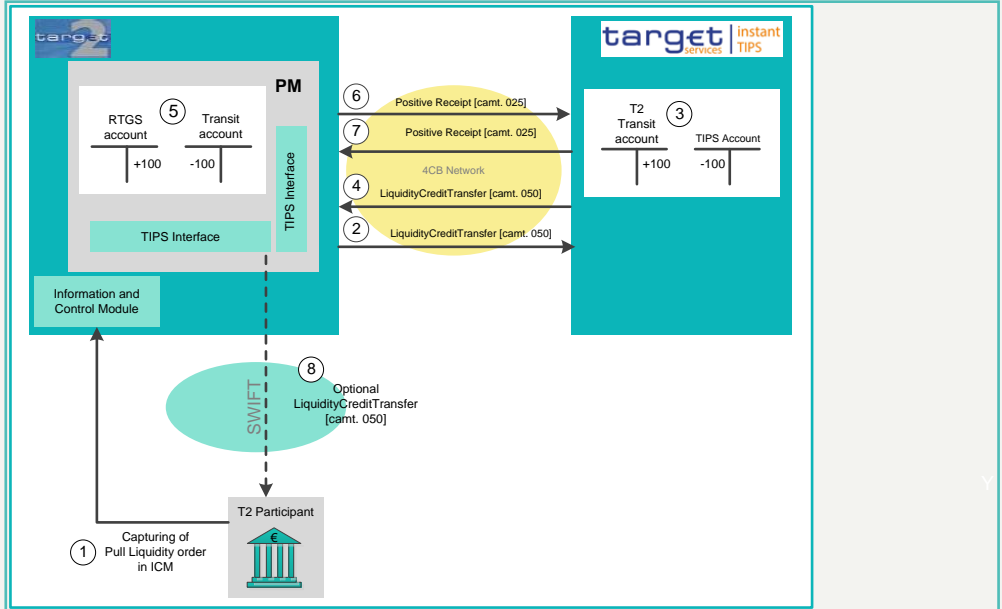

Step	Processing in/between	Description
1	TARGET2 part. → TARGET2	A TARGET2 direct participant initiates a liquidity transfer from TIPS to TARGET2 (pull liquidity) via TARGET2 ICM. The direct participant can select only an account number to be debited which is linked to his RTGS account. The account to be credited can be any RTGS account in TARGET2 (except AS-related and technical ones). Note: The sending DN is the DN matching the participant BIC in the DN-BIC matching table.
2	TARGET2 → TIPS	After successful validation TARGET2 sends a LiquidityCreditTransfer on behalf of the TARGET2 participant to TIPS via the 4CB network.

Step	Processing in/between	Description
3	TIPS	The liquidity transfer is validated. In case of successful validation the liquidity transfer is executed: The specified account is debited and the TARGET2 transit account is credited.
4	TIPS → TARGET2	A LiquidityCreditTransfer is sent from TIPS to TARGET2 via the 4CB network.
5	TARGET2	The liquidity transfer is validated. In case of successful validation the TIPS transit account is debited and the RTGS account of the TARGET2 participant specified in the liquidity transfer is credited.
6	TARGET2 → TIPS	TARGET2 sends a positive Receipt to TIPS via the 4CB network.
7	TIPS → TARGET2	A Receipt is sent to TARGET2 indicating the successful execution in TIPS.
8	TARGET2 → TARGET2 part.	As the incoming LiquidityCreditTransfer (step 6) will be processed as a new and independent business case (independent from the initial message in step 1), TARGET2 sends an optional LiquidityCreditTransfer to the TARGET2 participant via SWIFT. Note: In case of LiquidityCreditTransfer: The receiving DN is the DN stored in SD for this service.

2.10.4 Contingency measures

Scenarios

Contingency measures for TARGET2 participants performing liquidity transfers from TARGET2 to TIPS might be needed in case of:

1. unavailability of TARGET2 as a whole
2. unavailability of a TARGET2 participant or its communication infrastructure with TARGET2
3. regional SWIFT outage

First scenario - unavailability of the whole TARGET2

For the first scenario - unavailability of the whole TARGET2 - the tool which is available is the Enhanced Contingency Solution (ECONS I). This module can be used for a number of consecutive days (up to 5) with the possibility of closing the business day and processing critical and very critical payments. Liquidity transfers to TIPS could be classified as critical payments.

The Enhanced Contingency Solution does not offer an own ECONS I-TIPS interface for sending LiquidityCreditTransfer to TIPS. Therefore the settlement in the TARGET2 ECONS I will be done on the ECONS I accounts (Participant and TIPS transit account) without outgoing messages to TIPS.

For further information on the Enhanced Contingency Solution see [chapter 4 User Guide for Enhanced Contingency Solution \(ECONS I\), page 345](#) and [chapter 8 Enhanced Contingency Solution \(ECONS I\) - User Handbook, page 406](#).

Second scenario - unavailability of a TARGET2 participant or its communication infrastructure with TARGET2

In the second scenario - unavailability of a TARGET2 participant or its communication infrastructure with TARGET2 - specific contingency measures are provided by TARGET2 for certain actors, eg:

- responsible CB acting on behalf of the affected TARGET2 participant initiating a liquidity transfer to TIPS (“push”) via XML message (A2A) or via ICM (U2A)

Third scenario - regional SWIFT outage

In the third scenario - regional SWIFT outage - CBs and the SSP OT have access to the PAPSS via the Eurosystem's CoreNet contingency network (see chapter Contingency Network).

TARGET2 participants unable to access the PAPSS have to transmit via contingency means (agreed at national level) their instructions to their CB. Via CoreNet contingency network the CB (or SSP OT) is able to act on behalf of the affected TARGET2 participant initiating a liquidity transfer to TIPS (“push”) in ICM (U2A).

3 User Guide for Static Data Module (SD)

3.1 General overview

3.1.1 Main features

The Static Data Management Module provides the SSP service desk, CBs and SSP participants with a homogeneous set of data thanks to:

- A unique point for the creation, modification and deletion of static data.
- Daily data transmission for all the SSP modules including the provision of a coherent procedure according to which the data are synchronously loaded into all other modules at the same point in time.
- Exceptional procedures for urgent updates of all the modules in case of emergency.
- For audit trail purpose the central repository keeps the “tracking” for all data updates (date and reference).
- Static Data module is not meant to manage the past versions of static data. Those are made available via CRAKS services.
- Possibility to enter changes that become effective at a future date, including versioning facilities.

3.1.2 Users

Users of the Static Data module are:

- CBs for consultation and updates
- Credit institutions for consultation and updates (for specific credit institution data see chapter [3.2.3 Specific credit institution data, page 341](#))
- AS for consultation only

Main features

Users

- 3.1 General overview
- 3.1.3 Controls and responsibilities for data

- SSP service desk for consultation and updates

3.1.3 Controls and responsibilities for data

Controls and responsibilities

The entity in charge of data modifications is the one which is responsible for the data:

- CBs for all data related to the participant's structure and AS
- SSP service desk for production data such as opening/closing time, calendar, etc.
- Credit institutions for specific credit institution data (see chapter [3.2.3 Specific credit institution data, page 341](#))

This respective entity is also responsible for the manual controls to be carried out in context with possible changes. Controls consist of both automated and manual procedures. Automated controls on the data format have to be strictly applied to the data before it is used in the production environment. When information has to be checked against "subjective" elements, manual controls are carried out. In order to safeguard the integrity of data, manual controls and changes cannot bypass automated controls.

Depending on the implementation of RBAC roles, four eyes principle can be enforced for any static data creation and updates. Therefore each entity (in most cases CB) in charge of static data management will be able to define which data creation/updates are critical and should therefore be subjected to four eyes principle. In case of four eyes, any action has to be confirmed before making any other action.

Critical static data are all data needed for processing payments in the PM and HAM. It includes participant's public data, participant's private data, ancillary system data, specific CIs data and SSP data (see chapter [3.2 Static Data description, page 331](#)).

3.2 Static Data description

Data managed via ICM are represented by:

- the participant's structure (credit institutions and central banks)
- the AS
- specific data for SSP, such as TARGET calendar, monitoring data, etc.
- specific credit institution's data, such as default limits, standing orders and direct debit

According to the general principle regarding responsibilities on data ("The entity in charge of data modifications is the one which is responsible for the data"), CBs are responsible for all data related to the participants' structure and ASs which are in their area of competence. They are in charge of the update of data, integrity and controls.

In specific circumstances, SSP service desk is able to act on behalf of a CB. That is why SSP service desk has full rights to update all data of the participants' structure.

Similarly, SSP service desk is in charge of the update of production data.

For specific credit institution's data, only CIs are responsible for their data, but SSP service desk and CBs are able to update those, on behalf of a CI.

- 3.2 Static Data description
- 3.1.3 Controls and responsibilities for data

Participants public data

Entities	Responsibility
<ul style="list-style-type: none"> • Legal entity • Participant • Central bank • TARGET2 directory • Internet-based access • Group of accounts 	<ul style="list-style-type: none"> • CBs for their CIs
<p>Update:</p> <ul style="list-style-type: none"> • CBs for their CIs • SSP service desk 	
<p>Consultation:</p> <ul style="list-style-type: none"> • For published participants: All users • For unpublished participants: CBs: <ul style="list-style-type: none"> – Unpublished participants of its banking community – CB of GoA Manager: Unpublished members of GoA including members belonging to a different CB – CB of co-manager: Unpublished co-managed participants of another CB CI: <ul style="list-style-type: none"> – No unpublished participants except itself GoA manager: <ul style="list-style-type: none"> – No unpublished participants except its GoA members AS: <ul style="list-style-type: none"> – Unpublished settlement banks of the AS – Unpublished settlement banks where the AS operates as counterpart AS in a cross AS business relationship Co-manager: 	

3 User Guide for Static Data Module (SD)

- 3.2 Static Data description
- 3.1.3 Controls and responsibilities for data

Participants private data

Entities	Responsibility
– No unpublished participant except itself and its co-managed participants	

Entities	Responsibility
<ul style="list-style-type: none">• RTGS account (details)• Sub-account• Home account (details)• TIPS account• Standing facilities account (details)• Message notification type• Direct debit• BIC11 / distinguished names correspondence• Wildcard rules	<ul style="list-style-type: none">• CBs for their CIs
Update: <ul style="list-style-type: none">• CBs for their CIs• SSP service desk	
Consultation: <ul style="list-style-type: none">• CBs for their CIs• SSP service desk• CIs for their data• AS for their data	

3 User Guide for Static Data Module (SD)

- 3.2 Static Data description
- 3.1.3 Controls and responsibilities for data

Ancillary system

Entities	Responsibility
<ul style="list-style-type: none">Ancillary system	<ul style="list-style-type: none">CBs for their AS
Update: <ul style="list-style-type: none">CBs for their ASSSP service desk	
Consultation: <ul style="list-style-type: none">CBsSSP service deskAS managerSettlement bank of the AS	

Ancillary system

Entities	Responsibility
<ul style="list-style-type: none">Settlement bankBIC11 / distinguished names correspondenceBilateral agreement for Cross AS liquidity transfer	<ul style="list-style-type: none">CBs for their AS
Update: <ul style="list-style-type: none">CBs for their ASSSP service desk	
Consultation: <ul style="list-style-type: none">CBs for their ASSSP service deskAS managers for their dataAS with valid bilateral agreement are able to access other lists of settlement banks	

3 User Guide for Static Data Module (SD)

- 3.2 Static Data description
- 3.1.3 Controls and responsibilities for data

Public SSP data

Entities	Responsibility
<ul style="list-style-type: none">• TARGET calendar• TARGET events• TARGET contact list	<ul style="list-style-type: none">• SSP service desk• CBs Depends on contact type
Update: <ul style="list-style-type: none">• SSP service desk• CBs Depends on contact type	
Consultation: <ul style="list-style-type: none">• All users, depends on contact type	

Internal SSP data

Entities	Responsibility
<ul style="list-style-type: none">• SSP parameters	<ul style="list-style-type: none">• SSP service desk
Update: <ul style="list-style-type: none">• SSP service desk	
Consultation: <ul style="list-style-type: none">• SSP service desk	

3 User Guide for Static Data Module (SD)

- 3.2 Static Data description
- 3.2.1 Participants' structure

CI's specific data

Entities	Responsibility
<ul style="list-style-type: none">• Default limits• Standing order• Reserves	<ul style="list-style-type: none">• CIs
Update: <ul style="list-style-type: none">• CIs• Relevant CBs• SSP service desk	
Consultation: <ul style="list-style-type: none">• CIs (for their data)• CBs (for their CIs)• SSP service desk	

3.2.1 Participants' structure

Participants' structure

Participants' data are stored within the Static Data module in various groups of data (entity), in accordance with the type of data. Two main types of data can be distinguished:

- General information on participants, including CBs
- Information on account, held by participants and CBs
- **Legal entity**

This data allows to group general information about a participating institution. It also gives information on the way participant/accounts are linked together.

For example, if a credit institution needs to have more than one account in PM and/or HAM, it will need to create as many PM and/or HAM participants. The information that all these participants "are" the same credit

General information on participants, including CBs

institution is given by the fact that these participants are related to the same legal entity which describes the credit institution.

- **Participant**

Participants are all the participants of the SSP: that is to say all owners of an account, whatever its type: RTGS account and related sub-accounts, home account, SF accounts. In SSP participants are identified by a BIC-11 or a non-SWIFT BIC. Participants can be connected to SSP via SWIFT or via internet.

- **Central bank**

Central bank entity contains general information of all CBs which are participants in TARGET2 through the SSP (including ECB).

- **BIC Table**

This table groups information from the BankDirectoryPlus directory. Within the SSP, BICs are essentially used as attributes of SSP participants.

- **TARGET2 directory**

The TARGET2 directory entity stores all the needed routing information in order to support the routing of payments in TARGET2. It includes all data of a TARGET2 record: The participant's BIC, addressee BIC, account holder's BIC, institution name, city heading, national sorting code, participation type and main BIC flag (see chapter [9.4.2 Structure, page 603](#)).

- **Wildcard rules**

These are the wildcards rules defined for a participant (except Internet-based participant for which this feature is not available) to register addressable and multi-addressee BICs in the TARGET2 directory as defined in chapter [9.4.4 Administration by central banks, page 623](#).

Information on accounts, held by participants and CBs

The information on accounts, held by participants and CBs, consists of:

- **Group of accounts**

Group of accounts can be created for liquidity pooling (virtual account enabling an efficient cash management within a group of banks or between different branches and subsidiaries of a bank) or to consolidate information on liquidity in these banks or branches. Internet-based participants and CBs cannot be part of a group of account.

Groups of accounts can be implemented at:

- Domestic level:

A group of accounts is composed of accounts located at the same CB

- Intra-system level:

A group of accounts is composed of accounts held with different CBs. Access to information to a group of accounts by the respective entity is described in chapter [2.5.5 Pooling of liquidity, page 79](#).

- **RTGS account**

Account of each direct PM participant, CB and AS about whom the payments are settled. RTGS accounts are identified by the SWIFT BIC-11 of the participant. In addition, RTGS accounts are also identified by an account number.

- **Sub-account**

This is an account which is used only for settlement of AS transactions, in order to set apart, dedicated liquidity for this purpose. Sub-accounts are identified by an account number.

This sub-account is outside the group of RTGS accounts but belongs to one and only one RTGS account. Its balance is not consolidated by the liquidity pooling functionality.

Note: An account number is composed of country code and up to 32 characters (according to the current national account structure).

- **Home account**

Depending of the choice for the management of their home account in TARGET2 (SSP) by CBs, participants and respective CBs may use a dual accounting structure between the RTGS account and home account in SSP. In addition, home accounts are identified by the SWIFT BIC-11 of the participant. In addition, home accounts are also identified by an ac-count number. Home accounts can also be held by participants without RTGS account.

- **TIPS account**

These are the link rules defined for a participant to register links between a TIPS account and a participant or its RTGS account. The related static data insertion is performed in two-eyes mode only.

- **Standing Facilities account**

This entity specifies if a participant has an overnight deposit account or a marginal lending account, considering that its respective CB has chosen the SF module.

- **Message notification type**

This entity specifies the SWIFT message type a participant wishes to receive as notifications on SSP operations. Depending on SSP operations these notifications can be MT 202/900/910/940/950 for RTGS accounts and for HAM accounts. For Internet-based participants no message notification is foreseen. However Internet-based participants are able to download the account statement of the 10 previous business days.

- **Direct debit**

For each participant SD manages the information about the direct debit this participant has authorised and the related attributes (eg maximum amounts.). It is possible to authorise direct debits on RTGS account of an Internet-based participant. However Internet-based participants are not able to issue direct debits.

A user in an institution may need to consult or manage data related to several participants. In SSP users are identified by their SWIFTNet distinguished name (DN). Participants are identified by a BIC-11. As these BIC-

**Correspondence
BIC-11/
distinguished
names (DN)**

3.2	Static Data description
3.2.2	Data for ancillary systems management

11 are not necessarily derived from the DN's BIC-8, a matching table between DN and BIC-11 is needed to determine which participant data the user can access. This matching table is not based on the full DN but only on a DN suffix (ie DN without the common name part).

For the Internet-based participant, a virtual DN suffix has to be registered in the matching table. This DN suffix has to have the following structure:

o=SWIFT

o=<BIC8>

ou=ibp

ou=<BIC11>

BIC-8 and BIC-11 are respectively the BIC-8 and the BIC-11 with which the Internet-based participant is registered in the SSP.

Note: The above DN structure is reserved in SSP for Internet-based participants.

3.2.2 Data for ancillary systems management

Data for ancillary systems management

Data for ancillary systems (AS) is grouped in two different entities:

- General information on AS
- AS settlement banks

Ancillary system

AS are connected with SSP through the Ancillary System Interface (ASI). Ancillary system's information is managed by CBs.

According to their preferred functioning mode, ASs can choose several ASI functions. ASI manages the mechanisms connected to monetary policy transactions, liquidity injection and liquidity withdrawals, and specific procedures for the efficient settlement of their business (credit transfer and direct debit).

Information on AS includes settlement models and accounts used.

3 User Guide for Static Data Module (SD)

- 3.2 Static Data description
- 3.2.3 Specific credit institution data

AS settlement banks

The SD stores the list of settlement banks for each AS. This list includes settlement information for each settlement bank. Settlement banks are direct PM participants which RTGS account type is normal or CB (including Internet-based participant) which are not necessarily managed by the same CB to which the AS “belongs“. The settlement bank relation between a direct PM participant and an AS is valid for any of the settlement models used by the AS.

Cross AS bilateral agreement

The SD stores the bilateral agreements between ASs using procedure 6 interfaced or real-time who agrees to have Cross AS liquidity transfer enabled between their dedicated accounts, ie technical accounts – procedure 6 real-time in case of real-time AS and sub-accounts of the settlement banks in case of interfaced AS.

AS1 (belongs to CB1) and AS2 (belongs to CB2) have a bilateral agreement so CB1 establishes a link between AS1 and AS2 (status from AS1’s perspective = waiting counterpart agreement) and afterwards CB2 confirms the agreement (status = agreed).

Once agreed, this agreement allows:

- AS1 to debit SB1’s dedicated account (settlement bank assigned to AS1) and credit SB2’s dedicated account (settlement bank assigned to AS2).
- AS2 to debit SB2’s dedicated account (settlement bank assigned to AS2) and credit SB1’s dedicated account (settlement bank assigned to AS1).

3.2.3 Specific credit institution data

Specific credit institution data

These data are considered as Static Data. Nevertheless, from a user point of view, they can be updated and accessed through screens in the ICM RTGS menu. The reason for this is that they mainly consist of parameters enabling users to control their flows of liquidity.

Default limits

Default limits (bilateral and multilateral) can be stored for an RTGS account or a group of accounts in the SD.

Standing orders

A standing order can be set up for various liquidity transfers:

3 User Guide for Static Data Module (SD)

- 3.2 Static Data description
- 3.2.4 Credit institution specific T2S Static data

- liquidity transfer from an RTGS account to its sub-account(s)
- liquidity transfer(s) from an AS settlement bank's RTGS account to the technical account – procedure 6 real-time of the AS in model 6 real-time
- liquidity transfers from a RTGS account in TARGET2 to a Dedicated Cash Account in T2S.

Reservations

Reservations (urgent and highly urgent) can be stored for an RTGS account or a group of accounts in the SD.

3.2.4 Credit institution specific T2S Static data

Link of T2S Dedicated Cash Accounts to TARGET2 RTGS accounts

T2S uses dedicated central bank cash accounts (DCAs) for the cash settlement of securities transactions. Every DCA in T2S is linked to an external RTGS account. Also in TARGET2 the T2S DCAs are linked to the participant's RTGS account (daily automatic loading of the links stored in T2S static data). The link contains the BIC of the Dedicated Cash Account owner (BIC of the payment bank) and the Dedicated Cash Account number.

Standing order

A standing order can be set up for liquidity transfers from an RTGS account in TARGET2 to a Dedicated Cash Account in T2S.

Core services

The following services are defined at RTGS account level:

- Information on incoming liquidity transfer from T2S,
- Optional debit notification for liquidity transfer “push” on RTGS.

Flag for value added services

TARGET2 participants holding T2S DCAs have the possibility to opt for value-added services. These services can be subscribed as a package defined at participant level.

Correspondence BIC-11/ distinguished names (DN) for T2S actor in TARGET2

For each T2S actor in TARGET2, who needs to send a liquidity transfer (only available in A2A mode) on behalf of the credit institution, a link between the dn suffix of the T2S actor and the BIC of the credit institution has to be registered.

3.2	Static Data description
3.2.5	Credit institution specific TIPS Static data

Link of TIPS accounts to RTGS accounts

Standing order

Core Services

SSP data

TARGET calendar and TARGET events

3.2.5 Credit institution specific TIPS Static data

TIPS uses its own TIPS accounts for the cash settlement of Instant payments. RTGS accounts are linked with TIPS accounts via LM links (Liquidity Monitoring). Links are possible between one RTGS account and a maximum number of TIPS accounts. For performance reasons a limitation of the number of linked accounts has to be considered (a parameter in SD will be set to 10 accounts and shall not exceed 10 accounts).

A standing order can be set up for liquidity transfers from an RTGS account in TARGET2 to a TIPS account.

The following services are defined at RTGS account level:

- Current order liquidity transfer “push“ to TIPS,
- Current order liquidity transfer “pull“ from TIPS,
- Standing order liquidity transfer “push“ to TIPS (set up in SD),
- Debit notification for liquidity transfer “push“ on RTGS,
- Information on incoming liquidity transfer from TIPS,
- Intraday balance.

3.2.6 SSP data

SSP data are information needed to define the context of SSP operations. Some are public such as TARGET calendar and events and contact list, others are internal to SSP such as parameters (eg internal routing parameters).

This information is managed through two entities, TARGET days and TARGET event.

The TARGET calendar is represented by data stored in the entity TARGET days.

In this entity, for each date, the status of TARGET (Open/Close) is provided.

TARGET event entity stores events that define the chronology of a standard TARGET day. It contains:

- Opening and closing time of the SSP
- Cut-off time (customer/interbank payments and standing facilities)
- Specific cut-off times for HAM (eg for cash withdrawals)
- Specific cut-off times for T2S business (limit for liquidity transfers TARGET2/T2S)

These two entities aim at describing the chronology of a TARGET day within the SSP, as a whole and/or by CB.

TARGET contact list

The TARGET contact list aims to provide contact information for SSP operational needs (eg settlement teams contact). It is possible to define contact lists for each kind of SSP actors (CIs, AS, CBs ...).

Static Data access

3.3 Static Data access

Users may access to the SD through the ICM interface, in two access modes:

- User-to-application mode with ICM screens
- Application-to-application mode with XML requests (and XML answers from the SD)

4 User Guide for Enhanced Contingency Solution (ECONS I)

Aim and objectives

The Enhanced Contingency Solution (ECONS I) is a common mandatory tool for each CB and available to PM participants and Ancillary Systems joining the SSP. The ECONS I runs in the non-active region. It is an independent module which includes all the functions needed to access the SWIFTNet services. Considering the high level of resilience provided by the SSP, the use of the ECONS I is foreseen for a number of consecutive days (up to 5) with the possibility of closing the business day. It is envisaged for the processing of critical and very critical payments in specific situations, such as:

- Unavailability or inaccessibility of the SSP components.
- The time needed for the activation of the alternate site/region lasts too long.

It is at CBs discretion to determine which payments will be processed in the ECONS I; a CB is able to agree/disagree the processing of each payment inserted by the participants.

ECONS I only supports “straight forward payment processing” (no queuing mechanism is in place) and supports the processing of AS files (kind of settlement procedure 4) uploaded by CBs on behalf of the Ancillary Systems in A2A mode (no agree/disagree needed in this case).

Critical and very critical payments

The ECONS I ensures the processing of a limited number of critical and very critical payments. The concept of critical and very critical payments in TARGET2 defines payments which if processed with a delay could cause systemic risk.

Usage provisions

The following table describes the provisions applicable for the payments settled in the ECONS I:

Provision	Description
The payments can be made to	<ul style="list-style-type: none"> • Direct participants in the PM • Ancillary Systems • CBs • TIPS transit account • T2S transit account
Kinds of payments	<ul style="list-style-type: none"> • Limited number of critical and very critical payments (eg CLS) • Payment bulking (for CLS payments or other payments) in case of prolonged outage, when a larger number of critical payments needs to be processed • AS transaction files
Business information	<ul style="list-style-type: none"> • The underlying business information has to be sent from the CB to the receiver through separate channels (eg fax based), on best effort basis, when the receiver does not have access to ECONS I

Provision	Description
Payments input method	<ul style="list-style-type: none"> • Central banks via SWIFT WebAccess/InterAct (no use of SWIFTNet FIN service) and PM participants via SWIFT WebAccess) • CBs are responsible for agree/disagree each payment inserted by PM participants via U2A • CB uploads transaction files for Ancillary System on their behalf in A2A mode (no agree/disagree needed in this case)
Accounts	<ul style="list-style-type: none"> • Each PM direct participant has an account in the ECONS I (automatic repository, emergency procedure to open directly an account in the ECONS I is envisaged. That means accounts are opened automatically using the list of PM accounts when ECONS I is activated). These accounts are identified by the same BIC, but the usage of a different account number is advisable. • Each Ancillary System has at least an AS Technical Account that is a direct participant (Type Technical) with an account in the ECONS I (automatic repository). That means accounts are opened automatically using the list of PM accounts when ECONS I is activated. These accounts are identified by the same BIC, but the usage of a different account number is advisable.
Liquidity	<ul style="list-style-type: none"> • ECONS I accounts starting balances are always set to zero. • Liquidity is injected in the ECONS I accounts by the CBs.

Procedures for operating the ECONS I

The ECONS I is activated by the SSP operational team on request of the TARGET crisis management body.

The module is operated:

- by each CB for its own credit institutions and Ancillary Systems.
- by each direct PM participant (Type: Credit Institution) and Ancillary Systems.

- under exceptional circumstances, eg in the event of a contemporary unavailability of a CB (SWIFT unavailability at country level), by the SSP operational team.

The ECONS I accounts are normally blocked and it is not possible to use them to settle any transaction when the ECONS I is not activated.

When ECONS I is activated, the steps that are taken in order to inject liquidity, process payments and close the contingency procedure are listed in the following diagram and table.

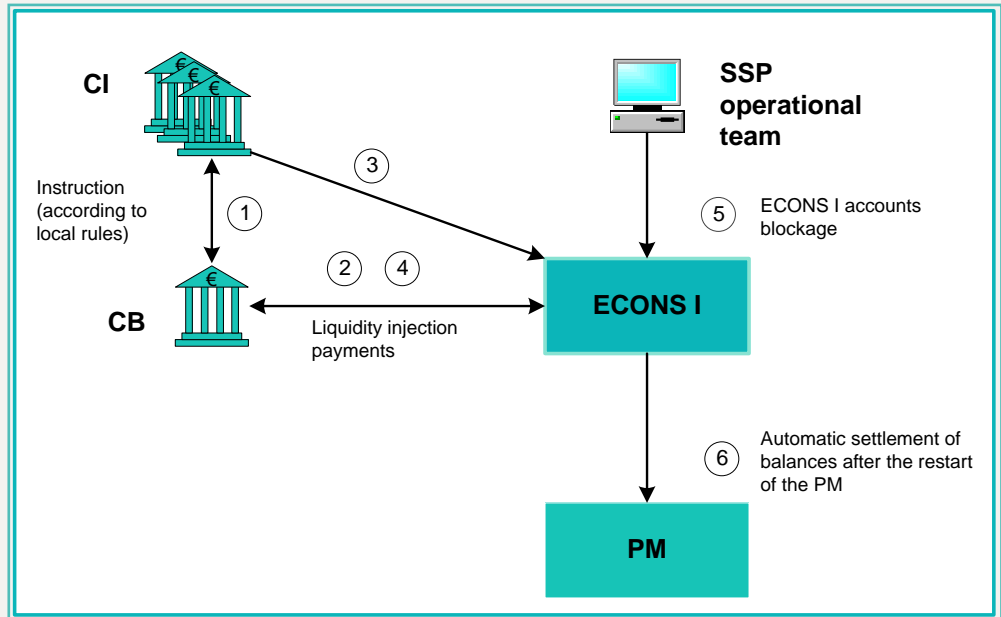

Step	Description
1	CI has to agree with its own local CB the way to provide liquidity to be used for settlement in ECONS I (existing payment capacity or new collateral provided using local procedures).
2	CB credits, with a SWIFTNet Browse/InterAct message, the agreed amount in the

Step	Description
	ECONS I account of the CI.
3	<p>CI, after verifying that enough funds are present on the account, inserts payment instructions in the ECONS I using SWIFT WebAccess. The following types of information are inserted by the participants:</p> <ul style="list-style-type: none"> • BIC of the sender participant (different only in case of CBs or SSP Operator acting on behalf) • BIC of the receiver participant • Value of the payment • Kind of payment (eg CLS)
4	CB verifies that the payment is critical or very critical and agree or disagree the processing.
5	<p>End of contingency process</p> <p>SSP operational team blocks ECONS I accounts, starting End of Day/Start of Day phase or closing the contingency session, avoiding the settlement of any new transactions.</p>
6	<p>After the restart of the PM, in order to set at zero ECONS I accounts and to transfer the respective liquidity to the PM, the amount of the balances of the payments settled in the ECONS I accounts are automatically sent to the PM. ECONS I performs transfer orders for amounts equal to the ECONS I account balances, crediting the PM CI's accounts and debiting the relevant PM CB's accounts.</p> <p>It is up to the CBs to inform CIs after the restart of the PM services, that the balances of the ECONS I accounts are booked in the PM.</p> <p>ECONS I sends an MT 940/950 to CIs (according to the choice done in the PM) to notify the list of payments settled during the contingency procedure. The MT 940 and MT 950 sent by ECONS I and PM have to contain different account numbers in order to allow CI to differentiate the payments settled on the two accounts. It is up to each CB to define the different account numbers when the RTGS account is created. During the contingency no SWIFTNet FIN messages are sent to CI in order to notify the payment settled in the ECONS I.</p>

Considering the possibility to use the ECONS I for a number of consecutive days (up to 5) and to close the business day, the SSP Operational team

have the possibility to start End of Day/Start of Day phase to apply the business day change. Inserting the date of the next business day the EoD change will be triggered immediately after submission.

General ledger, raw data files and CRSS data will be respectively sent out and provided at the end of each EoD performed in ECONS I session spanning over several business days.

The possible consideration of the additional liquidity provided in the ECONS I for the interim business days of the contingency session for the compulsory reserve has to be managed by the CBs manually.

The figure below shows an example of the transactions that can be processed in the ECONS I, the final balances of the ECONS I accounts and the transfer of liquidity to the PM at the closing of the contingency procedure.

<table border="1"> <thead> <tr> <th colspan="2">Payments to settle in ECONS I</th> </tr> </thead> <tbody> <tr> <td>UNCR → CLS</td> <td>: 70</td> </tr> <tr> <td>DEUT → CLS</td> <td>: 50</td> </tr> <tr> <td>CLS → BNPA</td> <td>: 65</td> </tr> </tbody> </table>	Payments to settle in ECONS I		UNCR → CLS	: 70	DEUT → CLS	: 50	CLS → BNPA	: 65	<table border="1"> <thead> <tr> <th colspan="2">BDI</th> </tr> </thead> <tbody> <tr> <td>-100</td> <td></td> </tr> <tr> <td colspan="2" style="text-align: center;">(-100)</td> </tr> </tbody> </table>	BDI		-100		(-100)		<table border="1"> <thead> <tr> <th colspan="2">BBK</th> </tr> </thead> <tbody> <tr> <td>-50</td> <td></td> </tr> <tr> <td colspan="2" style="text-align: center;">(-50)</td> </tr> </tbody> </table>	BBK		-50		(-50)		<table border="1"> <thead> <tr> <th colspan="2">BDF</th> </tr> </thead> <tbody> <tr> <td>0</td> <td></td> </tr> <tr> <td colspan="2" style="text-align: center;">(0)</td> </tr> </tbody> </table>	BDF		0		(0)								
Payments to settle in ECONS I																																				
UNCR → CLS	: 70																																			
DEUT → CLS	: 50																																			
CLS → BNPA	: 65																																			
BDI																																				
-100																																				
(-100)																																				
BBK																																				
-50																																				
(-50)																																				
BDF																																				
0																																				
(0)																																				
<table border="1"> <thead> <tr> <th colspan="2">Liquidity injections in ECONS I</th> </tr> </thead> <tbody> <tr> <td>BDI → UNCR</td> <td>: 100</td> </tr> <tr> <td>BBK → DEUT</td> <td>: 50</td> </tr> </tbody> </table>	Liquidity injections in ECONS I		BDI → UNCR	: 100	BBK → DEUT	: 50	<table border="1"> <thead> <tr> <th colspan="2">UNCR</th> </tr> </thead> <tbody> <tr> <td>-70</td> <td>+100</td> </tr> <tr> <td colspan="2" style="text-align: center;">(+30)</td> </tr> </tbody> </table>	UNCR		-70	+100	(+30)		<table border="1"> <thead> <tr> <th colspan="2">DEUT</th> </tr> </thead> <tbody> <tr> <td>-50</td> <td>+50</td> </tr> <tr> <td colspan="2" style="text-align: center;">(0)</td> </tr> </tbody> </table>	DEUT		-50	+50	(0)		<table border="1"> <thead> <tr> <th colspan="2">BNP</th> </tr> </thead> <tbody> <tr> <td></td> <td>+65</td> </tr> <tr> <td colspan="2" style="text-align: center;">(+65)</td> </tr> </tbody> </table>	BNP			+65	(+65)		<table border="1"> <thead> <tr> <th colspan="2">CLS</th> </tr> </thead> <tbody> <tr> <td>-65</td> <td>+70</td> </tr> <tr> <td></td> <td>+50</td> </tr> <tr> <td colspan="2" style="text-align: center;">(+55)</td> </tr> </tbody> </table>	CLS		-65	+70		+50	(+55)	
Liquidity injections in ECONS I																																				
BDI → UNCR	: 100																																			
BBK → DEUT	: 50																																			
UNCR																																				
-70	+100																																			
(+30)																																				
DEUT																																				
-50	+50																																			
(0)																																				
BNP																																				
	+65																																			
(+65)																																				
CLS																																				
-65	+70																																			
	+50																																			
(+55)																																				
<table border="1"> <thead> <tr> <th colspan="2">Payments settled in ECONS I</th> </tr> </thead> <tbody> <tr> <td>UNCR → CLS</td> <td>: 70</td> </tr> <tr> <td>DEUT → CLS</td> <td>: 50</td> </tr> <tr> <td>CLS → BNPA</td> <td>: 65</td> </tr> </tbody> </table>	Payments settled in ECONS I		UNCR → CLS	: 70	DEUT → CLS	: 50	CLS → BNPA	: 65	<table border="1"> <thead> <tr> <th colspan="2">Transfer Orders at end of contingency</th> </tr> <tr> <th>CM</th> <th>PM</th> </tr> </thead> <tbody> <tr> <td>BDI : +100</td> <td>BDI : -100</td> </tr> <tr> <td>BBK : +50</td> <td>BBK : -50</td> </tr> <tr> <td>CLS : -55</td> <td>CLS : +55</td> </tr> <tr> <td>UNCR : -30</td> <td>UNCR : +30</td> </tr> <tr> <td>BNPA : -65</td> <td>BNPA : +65</td> </tr> </tbody> </table>			Transfer Orders at end of contingency		CM	PM	BDI : +100	BDI : -100	BBK : +50	BBK : -50	CLS : -55	CLS : +55	UNCR : -30	UNCR : +30	BNPA : -65	BNPA : +65											
Payments settled in ECONS I																																				
UNCR → CLS	: 70																																			
DEUT → CLS	: 50																																			
CLS → BNPA	: 65																																			
Transfer Orders at end of contingency																																				
CM	PM																																			
BDI : +100	BDI : -100																																			
BBK : +50	BBK : -50																																			
CLS : -55	CLS : +55																																			
UNCR : -30	UNCR : +30																																			
BNPA : -65	BNPA : +65																																			

Note: After the closing of the contingency procedure in case the liquidity in ECONS I has been provided on the basis of new collateral and has not been reimbursed by the end-of-day, the CB will consider the liquidity provided as a marginal lending (based on the collateral received). As a consequence, the CB will have to use the direct debit the next day in order to have a refund of the capital and the interest; the SF module is not involved in this case.

Participants, via the interactive SWIFTNet services (InterAct and Browse), have real-time access to the following types of information:

Type of information	Content
Liquidity position	<ul style="list-style-type: none"> Account balance
Transactions processing	<ul style="list-style-type: none"> Transaction details (creditor, debtor, value, kind of payment) Status of transactions
Status of the system	<ul style="list-style-type: none"> Status of the contingency ("open", "closing", "closed")

Further information on contingency processing, the concept of critical and very critical payments, and the sources of liquidity to cover contingency payments will be provided in a separate operational documentation.

Note: For connecting to ECONS I with Internet Explorer 11 or higher it is necessary to set the compatibility mode of the browser to the value 10. The compatibility mode setting can be found in the developer tool, which opens when pressing F12.

Further information

4.1 User administration

4.1.1 Use of RBAC

General aspects

For the user administration the service “Role Based Access Control” (RBAC) offered by SWIFT is used. Therefore detailed information about the RBAC service is available at SWIFT.

Responsibility of participants

Each participant CB is responsible for managing his users, meaning that he is responsible for:

- designating the users
- assigning specific roles to each user

4.1.2 Overview of user roles for participants

Overview

The following list gives an overview of the participant user roles which have access to the Enhanced Contingency Solution.

For each user role the availability in the two eyes/four eyes principle as well as the specific actions characterizing the role are provided.

4.1 User administration

4.1.3 Login

Short name	User role	Two eyes/ four eyes principle	Specific actions
CUINFOTE ASIN-FOTE	Participant Read Information	Two eyes principle	Used to access the Enhanced Contingency Solution in U2A mode. Only allowed to read data
CUBAUPTE/ FE ASMANATE/FE	Participant Manager	Two eyes principle and four eyes principle	Used to access the Enhanced Contingency Solution in U2A mode. Allowed to read and to modify data: <ul style="list-style-type: none"> • enter payments

4.1.3 Login

The following steps are necessary to access the Enhanced Contingency Solution in U2A mode:

- Via the SWIFT Alliance WebPlatform the user must first gain access to SWIFTNet by entering its username and password. Once the “SWIFT user“ data are verified (username and password), the login procedure performs a mapping with the single, corresponding “SWIFT user“ whereby the system recognises the user and assigns the respective RBAC role.
- After the recognition has been processed, the user can select the browsing option.

In the browsing window for navigation the user has to enter the following specific Universal Resource Locator (URL) in order to access the Enhanced Contingency Solution:

<https://trgt-cm.ssp.browse.swiftnet.sipn.swift.com>

In order to access the Enhanced Contingency Solution for testing purposes, the following different URL has to be used:

<https://trgt-cm-cust.ssp.browse.swiftnet.sipn.swift.com>

4.2 Security

General remarks

ECONS I can be used to initiate sensitive interventions by the participants. ECONS I must therefore guarantee an appropriate level of security.

Security elements

This is achieved by:

- the use of security features provided by SWIFT as part of the SWIFT WebAccess services. The Services defined for the use of the Enhanced Contingency Solution are “**trgt.cm**” (for the live environment) and “**trgt.cm!p**” (for the test environment).
- defining different roles for the users.
- offering the “four eyes” principle as an option. Each participant can decide to which of the roles available to its users the “four eyes” principle will have to apply.

Note: The “four eyes” principle is not available for the application-to-application mode only available for CBs. In this mode the application developed by the CB has to support this feature.

Authentication of users

The following diagram shows the flow of a successful process of authentication:

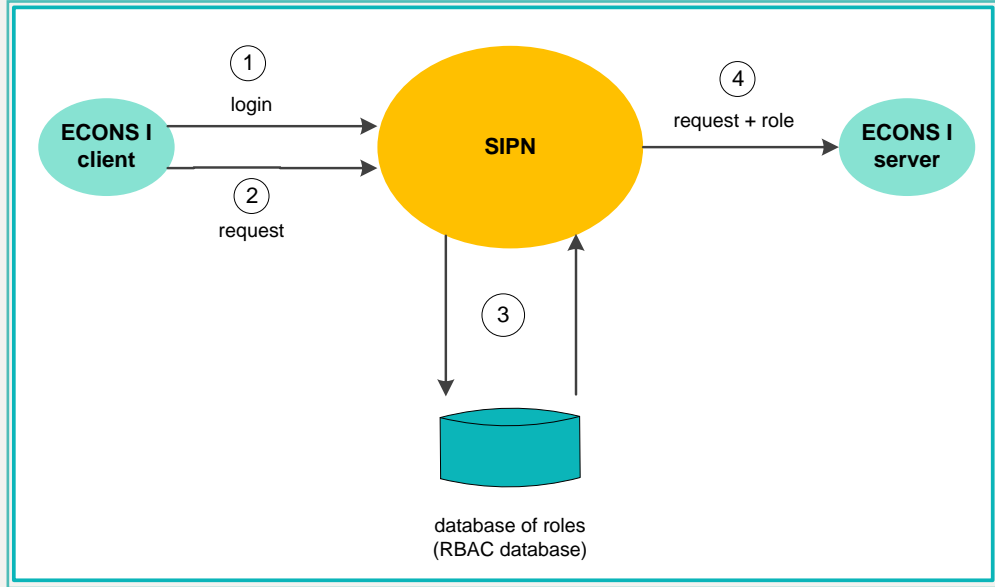

Step	Description
1	The user logs into the SIPN. Therefore the security elements requested by SWIFT are needed. After the successful login the user selects the ECONS I service.
2	The user sends a request to the server of the ECONS I.
3	SWIFT checks whether the user is registered in the RBAC service for ECONS I and adds the roles that are assigned to him to the message.
4	The message together with the roles is forwarded to the ECONS I server.

5 SSP Infrastructure

5.1 General architecture

Overview

The TARGET2 SSP is based on a centralised architecture, with a high level of redundancy, with the following main components:

- a central processing system (mainframe), for payment and accounting services
- Unix and Windows servers for SSP CRSS services
- a secure wide area network to connect credit institutions, market infrastructures and CBs (SWIFTNet)
- Internet access
- a Contingency Network (via CoreNet) to connect CBs in case of SWIFTNet outage
- a dedicated network (4CB network) to connect the different processing sites of TARGET2 and to interlink with T2S and TIPS
- system and application software
- front-end systems to interface SWIFTNet Network, Internet, CoreNet and the related services
- security systems (firewall, etc.)

Environments

The SSP needs multiple independent processing environments to support development, test and training as well as live operations. The number of environments fits the application development life cycle. A customer test environment should always have the same software configuration as the live environment.

To ensure the maximum availability of these environments, IT resources are dedicated to the SSP (ie storage, processing power, etc.) without any dependencies on other resources or service not belonging to the SSP.

As the TARGET2 SSP concentrates workload coming from former distributed TARGET system, the infrastructure guarantees high performance and adequate throughput thanks to a fully scalable architecture. In fact each component mentioned above can increase its capacity in a modular way.

Technical operation

The SSP technical operation is based on a high degree of automation to reduce human operator errors and simplify the manageability of the infrastructure. In addition SSP has a good level of controllability and audibility (confidentiality, integrity, user identification/authentication and access rights permission).

Rotation

The mainframe based operations is running alternatively in two different regions. In each region two sites are operative: the primary site and the secondary or recovery site.

It should be noted that the SSP offers a single interface to its users, ie they do not recognise in which region a certain module is running.

Moreover, rotation is fully invisible for CBs, users and market infrastructures, ie no configuration changes in SSP users' systems are envisaged.

Workload is distributed between the two regions: while region 1 hosts the live environment, region 2 manages the test and training environments and the contingency environment. Periodical swaps between the two regions ("rotation") keep technical and operational staffs always skilled in each region.

The system and the application software are kept updated in the two regions by means of hardware feature (asynchronous remote copy), so that after the rotation the system will restart with the same customisation (ie naming convention, security policies, management rules, etc.).

A third region is dedicated to the provision of services reserved of CBs, which are hosted on the CRSS platform.

The three regions are connected by a dedicated network with adequate bandwidth that guarantees file transfer services and remote copy of data from one region to the other.

SSP architecture - dedicated network (4CB network)

The TARGET2 architecture of the dedicated network illustrates the following slide:

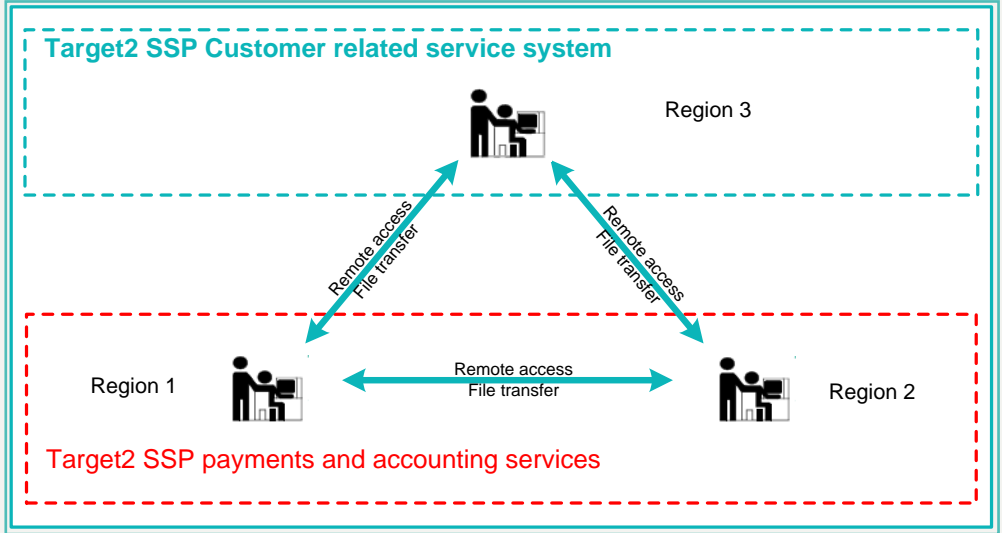

Besides the internal TARGET2 communication, the system is also connected with T2S and TIPS via the 4CB network. Both systems exchange XML messages without awareness about the active region of the other system:

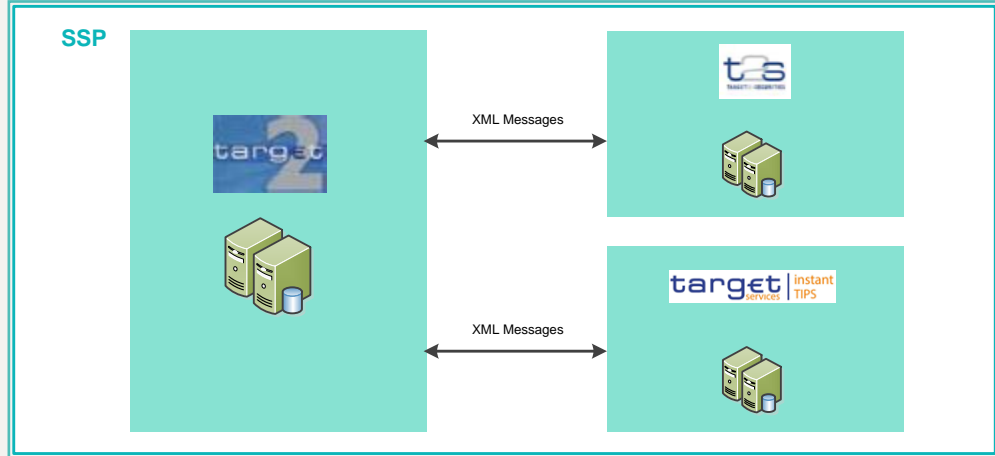

Security

The TARGET2 SSP is fully compliant with the TARGET Security Requirements and Controls (TSRC) established at the Eurosystem level. In particular security is managed at the host and network interface level.

The SSP perimeter defence is built by using network firewall systems to filter the communication and log the network access. To protect the SSP against intrusions and attacks coming from both internal and external people, it is under consideration the implementation of an integrated multiplatform security solution.

5.2 SWIFT Interface

Overview

The SWIFT Interface includes the SWIFTNet network and the hardware and software front-end infrastructures acceding SWIFT services.

SWIFTNet is a TCP/IP network with the following characteristics:

- high performance and availability
- high security (at the transport level (VPN) and session level)
- Public Key Infrastructure and certificates management for user identification and strong authentication

- data confidentiality (by means of cryptography)
- store/forward services required to retrieve eventually lost messages
- scalability

For the payments information exchange, the SSP uses the SWIFTNet FIN service. For the information and control services, the SSP uses the SWIFT-Net services (“InterAct”, “Browse” and “FileAct”).

5.3 Contingency Network

Overview

The Contingency Network is an alternative network to access the TARGET2 system in case of a regional or global outage of the SWIFT network. The Contingency Network is based on CoreNet - a closed network used by the Eurosystem to interconnect all national central banks and the ECB by providing multiple services.

Only CBs have a direct CoreNet connection to the SSP to enable the settlement of (very) critical payments on behalf of their participating credit institutions and ancillary systems. The connection between the CBs and their banking community in case of a contingency situation is left at the discretion of each CB (ie either an automated link or a paper-based link).

Some characteristics of the solution are:

- high availability
- high security
- data confidentiality

Access to the SSP via contingency network will be released by the SSP operational team in case of unavailability of the SWIFTNet.

Authenticated CB users will be able to monitor the payment processing and to insert (very) critical payments using the ICM browsing functionality and the possibility for AS files upload via ICM.

6 Operational model

6.1 Operating times and operational hours

The SSP complies with the general rules defined at the ESCB level for the TARGET2 operating days calendar and operating times. It is also able to cope with derogations from the long-term calendar for central banks (if decided by the Governing Council).

When setting up the daily time schedule for the SSP the following conditions have to be taken into account.

Time	Description
7.00 till 18.00	Day trade phase (payment processing)
17.00	Cut-off for customer payments
17.45	Cut-off for liquidity transfers to T2S
18.00	Cut-off for bank-to-bank transfers (including liquidity transfers to TIPS)
18.00 + 15 min	General cut-off for the use of “standing facilities“ CBs/collateral managers and the SSP Operational Team can send requests for marginal lending until 18.40. After this cut-off time these requests are rejected by the SF.
18.30	Cut-off for message input

Basics

General remarks

6 Operational model

6.1 Operating times and operational hours

Time	Description
18.00 + 30 min	Cut-off for the use of “standing facilities“ on the last day of a minimum reserve period CBs/collateral managers and the SSP Operational Team can send requests for marginal lending until 18.55. After this cut-off time these requests are rejected by the SF.
(shortly after) 18.30	Data to update the accounting system must be available at CBs (fifteen minutes later on the last day of a minimum reserve period)
by 8.00 (d+1)	Information to check the accuracy of the accounting data provided immediately after 18.30 must be available at CBs

Overview of the business day in PAPSS

Phases of the business day in PAPSS

Business day	TARGET working day	Phase	Description
d	d-1	18.45 - 19.00	Start-of-day processing (This period starts fifteen minutes later on the last day of the minimum reserve period.)
		19.00 - 19.30	Provisioning of liquidity <ul style="list-style-type: none"> • receipt of liquidity and interest from SF (overnight deposit) • debiting of reimbursement and interest from SF (marginal lending) • update of credit lines at the RTGS accounts (optional) (It is up to each CB to decide whether it will update credit lines in the evening or in the morning of the next TARGET working day) • Receipt of direct debits and credit transfers from proprietary systems (standing facilities) of CBs

6.1 Operating times and operational hours

Business day	TARGET working day	Phase	Description
			<ul style="list-style-type: none"> • settlement of intraday credit repo (optional) (It is up to each CB to decide whether it will set up repos in the evening or in the morning of the next TARGET working day) • transfer of liquidity from home accounts to RTGS accounts (standing order) <p>Note: HAM will execute the standing orders during this phase. For PHA it is up to each CB to decide whether to transfer liquidity to RTGS accounts during this phase or in the morning of the next TARGET working day.</p> <p>Note: PHAs will have to transfer the liquidity to the related RTGS accounts if the CB runs accounts for CIs which take part in the night-time processing of an AS.</p> <p>(This period starts fifteen minutes later on the last day of a minimum reserve period.)</p>
		19.30 - 07.00 (interrupted by a technical maintenance phase from 22.00 till 1.00)	<p>Processing of liquidity transfers to T2S/TIPS</p> <ul style="list-style-type: none"> • Start of execution of standing orders liquidity transfers to T2S and TIPS • Processing of current order liquidity transfers to T2S and TIPS <p>Setting aside liquidity and settlement of AS night-time processing (AS settlement procedure 6 only)</p> <ul style="list-style-type: none"> • ASI will initiate a “start of procedure message” to initiate the provisioning of liquidity for night-time processing (19.30) • automatic execution of standing orders to transfer liquidity to sub-accounts or technical accounts – procedure 6 real-time for night-time processing after the initiation of the “start

Business day	TARGET working day	Phase	Description
			<p>of procedure message“</p> <ul style="list-style-type: none"> • execution of additional liquidity transfers (via ICM) from <ul style="list-style-type: none"> – PHA/HAM to RTGS accounts – RTGS accounts to sub-accounts (and vice versa)/technical accounts – procedure 6 real-time <p>before the AS sends a “start of cycle message“ to ASI</p> <ul style="list-style-type: none"> • AS sends a “start of cycle message“ to ASI <p>Note: From this time on liquidity on the sub-accounts for night-time processing will be blocked till the “end of cycle message“ is sent by the AS (only AS working on interfaced basis).</p> <ul style="list-style-type: none"> • increase of dedicated liquidity <ul style="list-style-type: none"> – from auto-collateralisation – from coupons and redemption • AS transfers settlement requests to ASI • settlement takes place • AS sends an “end of cycle message“ <p>Note: It will be possible for an AS to run several cycles during the night-time processing. That means an AS can send several “start of cycle/ end of cycle messages“. Between an “end of cycle message“ and a (new) “start of cycle message“ liquidity adjustments initiated (eg by the AS) will be taken into account.</p>
	d		<ul style="list-style-type: none"> • AS sends an “end of procedure message“. After that the liquidity on the sub-accounts will be retransferred to RTGS accounts automati-

6.1 Operating times and operational hours

Business day	TARGET working day	Phase	Description
			<p>cally.</p> <ul style="list-style-type: none"> • update of credit lines (It is up to each CB to decide whether it will update credit lines in the evening of the previous TARGET working day or in the morning of the current one.) • transfer of liquidity from PHA to the RTGS account (if applicable) <p>Note: HAM will execute the standing orders in the evening of the previous TARGET working day. For PHA it is up to each CB to decide. Whether to transfer liquidity to RTGS accounts in the evening of the previous TARGET working day or during this phase.</p> <p>(This period starts fifteen minutes later on the last day of the minimum reserve period.)</p>
		6.45 - 7.00	<p>Business window to prepare daylight operations</p> <ul style="list-style-type: none"> • activation of standing orders for “highly urgent” and “urgent” reservations
		7.00 - 17.00	<p>Day trade phase (I)</p> <ul style="list-style-type: none"> • customer payments • bank-to-bank payments • AS settlement • CB operations • current order liquidity transfers to T2S • current order liquidity transfers to TIPS
		17.00 - 17.45	<p>Day trade phase (II)</p> <ul style="list-style-type: none"> • return of pending customer payments • bank-to-bank payments • AS settlement

6 Operational model

6.1 Operating times and operational hours
 4.1.3 Login

Business day	TARGET working day	Phase	Description
			<ul style="list-style-type: none"> • central bank operations • current order liquidity transfers to T2S • current order liquidity transfers to TIPS
		17.45 - 18.00	Day trade phase (III) <ul style="list-style-type: none"> • AS settlement • bank-to-bank payments • central bank operations • The manager of group of accounts must balance the accounts involved in the grouping of accounts. • current order liquidity transfers to TIPS
		18.00 - 18.45	End-of-day processing <ul style="list-style-type: none"> • automatic emergency procedure to transfer liquidity from sub-accounts to the related RTGS accounts • return of pending bank-to-bank payments • automatic emergency procedure if group of accounts manager was not able to balance the accounts in time and there is one uncovered overdraft on one account belonging to a group of accounts • automatic transfer of liquidity to PHA (optional) • overnight deposit: transfer of liquidity to the SF accounts (optional) • marginal lending: "on request": booking of "overnight credit" to the SF accounts (optional) • automatic transfer of overnight credit from SF to RTGS account in case of use of intraday credit at the end of the day (optional)

Business day	TARGET working day	Phase	Description
			<ul style="list-style-type: none"> • automatic transfer of liquidity to HAM account (optional) • transfer of information to the RM (optional) (This period ends fifteen minutes later on the last day of a minimum reserve period.)

Opening business day

Start-of-day processing

The opening time refers to the moment when the Payments Module (PM) is ready for opening the business day after a kind of preparation phase.

There will be no differences in the opening of PM for the processing of intra-PM and cross-PM payments. In addition, the HAM and the other modules will be available for transactions.

As mentioned above, the current business day (d) will be opened in the evening of the previous TARGET working day.

End of day trade phase and end-of-day processing (cut-off times)

In PM there are four cut-off times in place - beside optional cut-off times that can be defined by AS. After the specific cut-off time is reached no new payments affected by this cut-off time will be accepted in PM. New payments will be rejected or parked outside the system for later rejection. The sender is informed by an MT 019 with a specific error code (except payments with future value date, see chapter [2.4.4 Warehouse functionality, page 57](#)).

Normally:

- 17:00: Cut-off for customer payments
- All queued customer payments will be rejected after the last run of algorithm 3 (including customer payments) has finished (time for covering). It is assumed that most of the ancillary systems have settled before the

cut-off for customer payments. Specific types of transactions stemming from AS (money market, DVP, etc.) can be settled via ASI till 18.00.

- 17.45: Cut-off for current order liquidity transfers to T2S and start of re-transfer of liquidity from the T2S DCA accounts to TARGET2.
- 18.00: Cut-off for inter-bank payments, liquidity transfers to TIPS and incoming liquidity transfers from T2S and TIPS.
- All queued payments will be rejected after the last run of algorithm 3 has finished (time for covering).
- 18.30: Cut-off for message input
- SWIFT input queues are closed and incoming messages are parked outside the SSP till the start of the new business day.

Abnormal situations:

In order to cope with abnormal situations the cut-off times are defined by using a parameter, which can be changed. The PM would be able to cope with the shortest possible time for changing the parameters not yet reached.

6.2 Customer contacts

Basics

Each CB will remain fully responsible for the operational relations vis-à-vis its participants. However, all the operational features of the system will be defined with respect to the level playing field commitment of the Eurosystem. Therefore, the services offered by the SSP will be uniform, irrespective of the CB or banking community to which they are provided.

In this context each CB will provide a business helpdesk in charge of operational customer contact.

Further information

Further information on customer contact and the business helpdesk function will be provided in a separate operational documentation.

6.3 Problem management and contingency procedures

TARGET2 is the vehicle for processing systemically important and other large-value payments in euro. The Eurosystem is fully aware of this prominent role of TARGET2 as market infrastructure as well as of the very demanding user requirements. Therefore, top priority is attached to the system's operational reliability. If nevertheless an abnormal situation should arise, the Eurosystem stands ready with effective problem management and contingency procedures. All these procedures will ensure a timely and efficient incident management, a thorough and timely dissemination of information, a quick recovery and resumption of full processing capacity, and the smooth processing of critical and very critical payments in the meantime.

As regards the restart after disaster process dealing with the extreme case of complete unavailability of one of the two regions on which the SSP runs and loss of data, an overview is provided in chapter [6.4 Restart after disaster, page 370](#) of the present book.

Further information on the problem management and contingency procedures is provided in a separate operational documentation.

Basics

Further information

6.4 Restart after disaster

6.4.1 Overview

General remarks

The technical architecture of the SSP, which is based on the “two regions x two sites” concept aims at covering a comprehensive set of disaster scenarios and enables the PAPSS to perform its activities under abnormal circumstances and guarantee a high level of availability whatever the situation is.

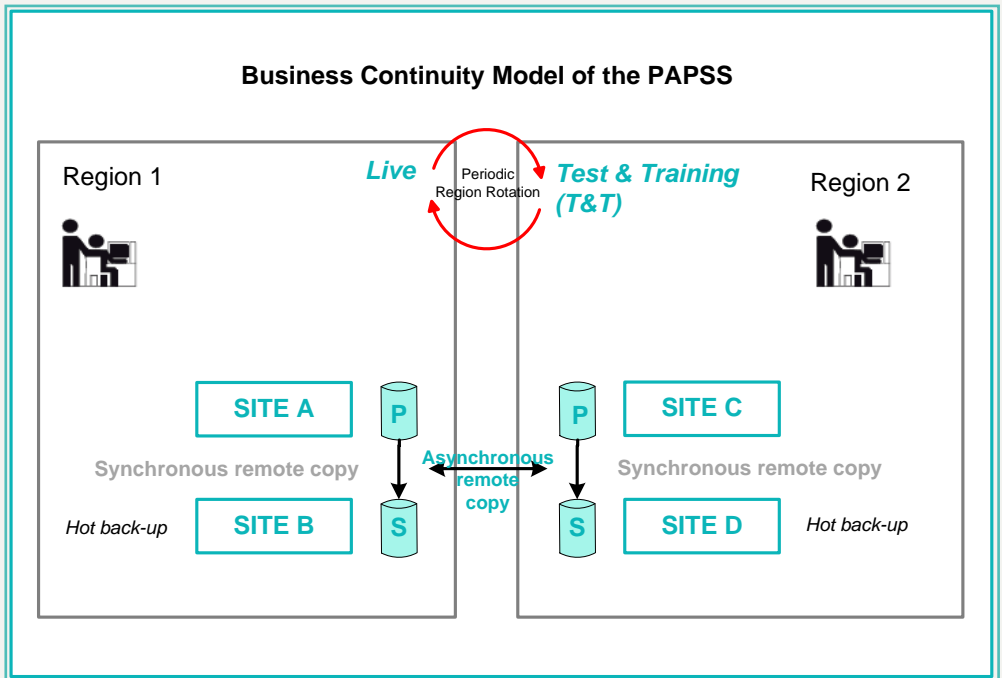

In detail, the following events are covered by the business continuity model of the PAPSS:

- Short continuity failures are covered by the redundancy of the main critical elements within the same site,

- Major failures or disasters (disruptions caused by fire, flood, terrorist attacks or major hardware/telecommunications faults) require the activation of the alternative site in the same region,
- A “wide scale regional disruption“ that causes severe permanent interruption of transportation, telecommunication, power or other critical infrastructure components across a metropolitan or a geographical area requires the activation of region 2.

However, in some very exceptional cases (with a so low likelihood that it is impossible to assess it, eg sudden, unpredictable and simultaneous destruction of the two sites of the region 1 or destruction of the production site and the network between the two regions at the same time), a situation could occur when there is no sufficient time to close properly the production before the disaster. This means that data which were processed in region 1 in a time span of approximately 2 minutes before the disaster were not copied to region 2 due to the asynchronous remote copy technology of the PAPSS. Therefore, these data are not available in region 2.

In order to cope with this situation, the 3CB in co-operation with SWIFT have studied and designed a special reconstruction process which will allow in any circumstances the best possible recovery. The 3CB are confident that this process can be completed within a timeframe compliant with the SLA (2 hours after the decision to switch the production site to the second region). This solution has been designed to recover the situation after a major crash but does not deal with liquidity issues in case of European-wide crisis in the banking community. The Eurosystem will have therefore to define a general plan of action to deal with this issue.

The reconstruction process is based on the following principles:

- Relying on the sole existing retrieval capabilities of SWIFT for FIN messages (no retrieval capabilities are available for InterAct/FileAct services),
- Settling the payments/liquidity transfers using the standard algorithms implemented in the SSP (no uncovered balances) with specific mechanism to allow the settlement in region 2 of all operations already settled in region 1. The transactions, which were already confirmed to the participants, will be processed prior in the resettlement.

Reconstruction process

- Complementing the settlement procedure with manual reconciliation procedures (if necessary, mainly based on the use of the ICM) once the SSP has restarted.

The number of payments handled within the reconstruction process can be assessed as follows: the SSP processes an average of 38 000 transactions an hour and 105 000 transactions during the peak hour. Assuming that the time gap does not exceed 2 minutes - which is considered as conservative by the technical experts - the average number of transactions processed in region 1 and not duplicated in region 2 is on average 1 300 (and 3 500 peak hour). These numbers will therefore be considered in the reconstruction process.

The whole procedure aims at restoring the consistency between region 1 and region 2 at the moment of the disaster. However, due to the technical constraints mentioned above (no retrieval capabilities for SWIFTNet Inter-Act/FileAct services, asynchronous remote copy technology), it will not be possible to restore in region 2, in a fully automated manner, the perfect image which prevailed in region 1 before the regional disaster.

6 Operational model

- 6.4 Restart after disaster
- 6.4.2 Technical restart of region 2 as SSP environment

The following scheme describes the different steps of the restart.

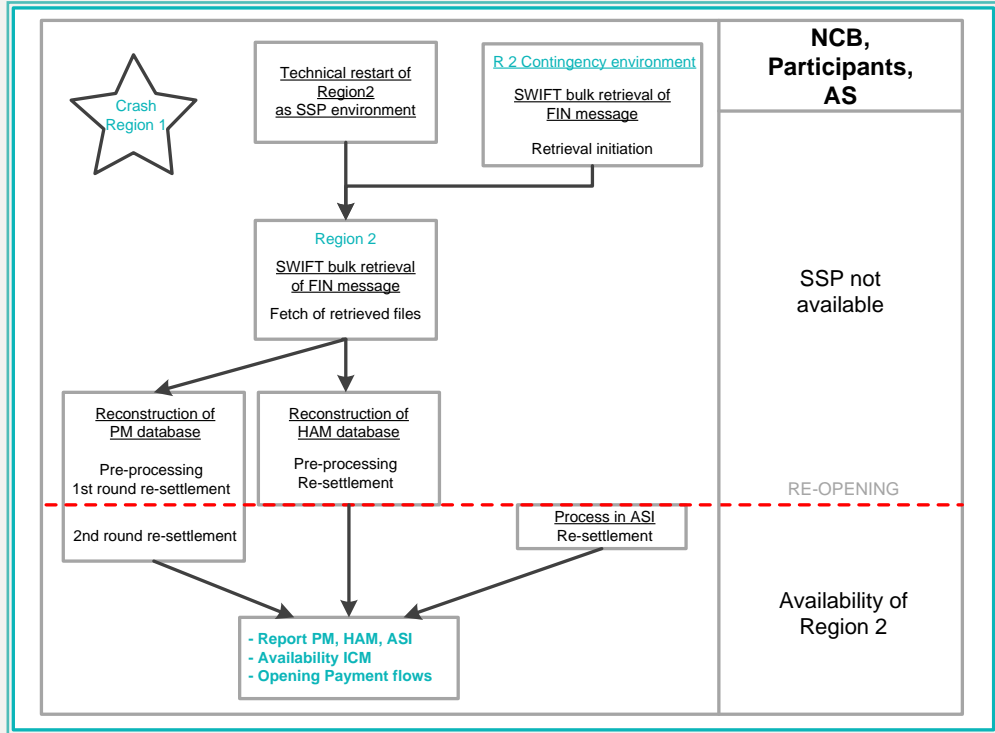

6.4.2 Technical restart of region 2 as SSP environment

The region 1 hosts the live environment. The region 2 manages the test & training environments and the contingency environment. Periodical swaps between the 2 regions are done in order to ensure that the system and the application software are kept updated in the 2 regions and that every region can take over the production without any specific difficulty.

In case of a crash of region 1, the region 2 which was operating as Test & Training environment, has to be reactivated in order to become the live environment. First the contingency environment is activated immediately and, in

parallel, operations to prepare the restart of region 2 as SSP environment start. From a technical point of view, the restart of the region 2 means:

- Stop the Test and Training process,
- Trigger the technical connection,
- Activate the rollback of the database,
- Check the database consistency for all affected SSP components: PM, HAM, SWIFT Interface (GARI), SD.

At the same time, a request is sent to SWIFT from the contingency environment in order to retrieve the FIN messages.

6.4.3 Description of the reconstruction process

The process starts in the contingency environment of region 2 and after the total activation of region 2, proceeds on the region 2, production environment.

6.4.3.1 SWIFT bulk retrieval of FIN messages

The first step of the procedure is the SWIFT bulk retrieval of the relevant FIN messages sent from/received by the affected modules shortly before the disaster, that might not have been copied to region 2 (ie those messages which have been confirmed from or to SWIFT via ACK, NAK versus region 1 but where this information has not been copied to region 2). The process is under the responsibility of the SSP Operational Team which will initiate the retrieval. The time frame for the retrieval of the SWIFTNet FIN messages will cover the approximately 2 minutes before the disaster plus an appropriate safety margin.

The messages to be retrieved for the re-settlement within the modules are:

- MT 096, 097 (Y-copy)
- MT 103, 103+, 202, 202 COV, 204 (only input message)
- MT 202 (only output message of PM)

- MT 012, 019 (input messages for HAM)

The retrieval is a two-step process: retrieval initiation and fetch of retrieved files. Details are described in the related SWIFT document “TARGET2 Disaster Recovery Retrieval Guide”.

6.4.3.2 Reconstruction of the PM database

6.4.3.2.1 General remarks

This chapter describes the general principles of the processes in region 2 concerning PM starting from the point of time when the SWIFT retrieved data are available at SSP level. The processes are steered by an automatic workflow initiated by the SSP Operational Team. The general idea is to rebuild the database of PM depending on the different business cases which are possible in PM according to two major steps:

- Pre-processing
- Re-settlement

Additionally, a report (after the first round of re-settlement) allows the participants being informed about payments/liquidity transfers, which were previously settled in region 1 and now are “pending” after the first round of the re-settlement in region 2. For the report see chapter [6.4.5 Manual reconciliation - Reporting, page 382](#).

6.4.3.2.2 Business cases considered

This general idea is adapted to the different business cases in PM, which are considered for a reconstruction in PM.

- Business cases for which a reconstruction is envisaged:
 - Regular Payments (Y-copy) (this includes payments issued by Internet-based participants via ICM, which were already sent out by PM to SWIFT as Y-copy payment)
 - Liquidity transfers from PHA accounts to RTGS accounts
 - Payments (Y-copy) from HAM-CB customers to RTGS accounts

- Liquidity transfers from RTGS accounts to PHA accounts
- Backup payments (via ICM) for which the settlement information can be identified in MT 202 output of the retrieval.
- Business cases for which a reconstruction is not envisaged: all respective transactions, which do not have a final status in region 2 will be cancelled completely for the following reasons:
 - Internal messages which have not been copied to region 2 cannot be reconstructed (owing to the fact that there is no SWIFT retrieval capacity for internal messages).
 - Internal messages which have been copied to region 2, but which are still pending, should not be executed since the liquidity position in region 2 after the restart might be different from the position before the disaster; consequently it should be left to the participant to decide whether the transaction should be executed (in this case it needs to be resubmitted).

In detail the affected business cases are:

- Payments issued by Internet-based participants via ICM, where the Y-copy output to SWIFT is not yet generated in PM (also the settlement is not yet done, because the payment will not be settled before the incoming MT 096)
- Liquidity transfers from RTGS accounts to sub-accounts and vice versa (via ICM)
- Liquidity transfers from RTGS accounts to technical accounts – procedure 6 real-time (via ICM)

Note: Due to the general design of the real-time model a reconciliation between the settlement banks and the AS is necessary.

- Liquidity transfers from RTGS accounts to HAM accounts and vice versa (via ICM).

Note: In those latter two cases, the transactions are not cancelled in the PM, but are processed in 1st attempt (when queued in region 2) or after the 1st attempt by re-starting the interrupted process chains.

For AS transactions, see chapter [6.4.3.4 Process in ASI, page 380](#).

6.4.3.2.3 Pre-processing

This step aims at preparing the SWIFT retrieved data and the data available in PM in region 2 for the re-settlement. It consists of three sub-steps (partly in parallel):

- Match the SWIFT retrieved MT 096/097,
- Check by means of specific internal procedures in PM of region 2, which data were copied from region 1 to region 2,
- Assign the SWIFT retrieved data to the data copied to PM in region 2. In the different business cases, this results in different scenarios. The further internal processing depends on the respective scenario.

6.4.3.2.4 Re-settlement

This step aims at restoring the balances on the accounts kept in PM to be as close as possible to the situation in region 1 and to go ahead, consisting of two sub-steps:

- First round of re-settlement taking into account those transactions already confirmed as “final” vis-à-vis the participants (via output MT 097/202) on a best effort basis. The first round of the re-settlement can result in three groups:
 - Transactions rejected:
Those transactions have been rejected in the re-settlement process because they have already been settled in region 2 (rejection due to duplicate execution). The consistency concerning the status of those transactions between region 1 and region 2 (“final”) is given.
 - Transactions settled:
Those transactions have been settled in the re-settlement process. The consistency concerning the status of those transactions between region 1 and region 2 (“final”) is re-established.
 - Transactions pending:
Those transactions are pending after the re-settlement process, for example due to a lack of liquidity at the debtor’s side. In this case, the

status of the transaction in region 2 (“pending”) after the re-settlement is different from the payment status in region 1 (“final”) before the disaster. This inconsistency will be reported to the participants after the first round of the re-settlement (see chapter [6.4.5.1 Report to participants related to PM, page 382](#)).

Out of the first round of the re-settlement, MT 900/910 (optional) will be sent with a PDE trailer to inform the participants about possible duplicate information on payments.

Note:

- * The “pending” transactions in which an execution time is stored (codeword “REJTIME”) will not be rejected after the reopening of the SSP. To avoid the rejection of retrieved or still queued payments in region 2 with the codeword “REJTIME”, the time will be set to “23:59”. A participant can decrease the time in region 2 if he wants, otherwise, he can revoke. Payments with the codeword “TILTIME” will be treated without any difference to normal processing.
- * After the SWIFTFIN retrieval and after the first set of re-settlement, the system puts automatically at the top of the highly urgent queue the payments settled in region 1 but which cannot be settled in region 2 because of lack of liquidity.
- The second round of re-settlement (in parallel to the normal processing after the re-opening of the SSP) is taking into account the transactions not successfully settled in the first round and transactions already available in PM but not confirmed as “final” vis-à-vis the participants. In the second round of re-settlement MT 900/910 (optional) will be sent with PDE trailer.

6.4.3.3 Reconstruction of the HAM database

6.4.3.3.1 Pre-processing

In HAM the retrieval process is executed only for input FIN payments (MT 202/202 COV/103/103+) and FIN system messages (MT 012/019) and not for output FIN messages. In fact, for each input message there is not always

an output message since MT 900/910 are sent on an optional basis and FIN output messages are not always present.

As a consequence the pre-processing has only to receive all the retrieved message and then sent all of them to the HAM application.

6.4.3.3.2 Re-settlement

The retrieved payments are sent to HAM for settlement using the same order of the messages sent by SWIFT. For these payments, there are three different possibilities:

- (i) Payments already received in region 2 (settled, rejected or queued) are rejected on the basis of the duplication check control;
- (ii) Payments not yet received in region 2 for which there is enough liquidity are settled;
- (iii) Payments not yet received in region 2 for which there is not enough liquidity are queued.

The HAM process that receives these payments is the same process as the one used for normal operation. Nevertheless, in order to inform the users about possible duplicate information on payments, all output FIN messages sent by HAM, are produced with the PDE indicator (both messages present but not settled in region 2 at the moment of the restart and retrieved payments).

If the input message (received by HAM) is already memorised in region 2 inside the HAM application (also as queued) the output message produced by HAM normally uses the same TRN of the message already produced in region 1.

On the contrary, if the input message is not already memorised in region 2 inside the HAM application, the output message produced by HAM uses a different TRN with respect to the message already produced in region 1.

6.4.3.4 Process in ASI

AS processing being specific both in messaging and in workflow, it is not possible to have recourse to message retrieval in order to re-build in region 2 the situation that prevailed before the crash.

As a consequence, the process of restart after disaster for ASI will mainly consist in finalising the transactions that are pending in the SSP and issuing reports towards the users, so that they are aware of the new situation of transactions and accounts which is possibly quite different from the one that prevailed in region 1.

6.4.3.4.1 Pre-processing

From AS point of view, pre-processing involves no message retrieval. It only has to be ensured that the databases are consistent and that all transactions that were pending at the time of the crash in region 2 are either completely rolled back or ready to be integrated again in the settlement process when it resumes.

6.4.3.4.2 Re-settlement

AS payments that are settled by algorithm 3 in normal processing (settlement model 1, 2, 3 and 4 debit side) will be included in the 1st attempt, because these payments were already queued when payments of the retrieval had been settled in region 1. Not taking these payments into account leads to a different situation than in region 1 and might not lead to a better result. On the technical side there is no processing for removing AS payments from the queue, parking them and put them into the queue again after the 1st round of re-settlement (see chapter [6.4.3.2.4 Re-settlement, page 377](#)).

In order not to reject payments after the reopening of the SSP, the information and settlement period will be changed as following:

- For transactions containing an information period which had not elapsed at the time when the crash occurred:
 - all transactions with an information period which had not been elapsed at the crash-time are identified,

- the new end of information period is set at a time “x” defined by the operational team upon Level2 instruction. This time is the same for all transactions concerned. It can be defined or changed until the 1st round of settlement. By default, it is set to 30 minutes after the start of the 1st round of settlement.
- For transactions containing a settlement period which had not elapsed at the time when the crash occurred:
 - all transactions with a settlement period which had not been elapsed at the crash-time are identified,
 - the new end of settlement period is set at a time “y” defined by the operational team upon Level2 instruction. This time is the same for all transactions concerned. It can be defined or changed until the 1st round of settlement. By default, it is set to 60 minutes after the start of the 1st round of settlement.

6.4.4 Reopening

Five steps in the re-opening process are defined:

1. In case of inter-region failover, the Operational Team sends a message to the users (AS) to stop their InterAct and FileAct flows.
2. After the SWIFTFIN retrieval and after the first set of re-settlement (described in the chapter [6.4.3 Description of the reconstruction process, page 374](#)), the system puts automatically at the top of the highly urgent queue the payments settled in region 1 but which cannot be settled in region 2 because of lack of liquidity.
3. Opening of the InterAct and FileAct flows to allow the users to have a snapshot of their situation and in parallel processing of the in-flight flows. Participants and AS have to resend flows already available in region 1 and not available in region 2.
4. Enforceability step: CBs will increase the credit lines using ICM to make sure that payments/liquidity transfers settled in region 1 but not in region 2, are settled and after the settlement send instruction in order to decrease the credit lines.

6.4 Restart after disaster

6.4.5 Manual reconciliation - Reporting

5. Full re-opening is then possible for FIN traffic and a message will be sent to AS to restart the sending of InterAct and FileAct flows.

6.4.5 Manual reconciliation - Reporting

6.4.5.1 Report to participants related to PM

The report aims at informing the participants about payments and liquidity transfers, which were settled in region 1 and now are “pending” after the first round of the re-settlement in region 2. For the report a general broadcast will be sent to all participants (CBs, CIs and AS). The broadcast will include:

- The request to display via specific ICM inquiry screen all “pending” transactions which previously had a “final” status in region 1 (“pending” transactions after the first round of re-settlement in region 2),
- The request to observe these transactions intensively, because their “pending” status can change during the normal processing after the re-opening of the SSP,
- The warning that these payments will be rejected if they are still “pending” at the end of the business day.

The report will be realized only in U2A. Each affected participant has to call a specific ICM inquiry screen. The ICM inquiry screen is activated for the participants within the automatic workflow initiated by the SSP Operational Team and deactivated within the end of day-processing of the business day. Due to the fact that the status of the reported transactions can change from “pending” to “final” within the normal processing after the re-opening of the SSP, the ICM inquiry screen has a dynamic display (ie a “refresh” of the displayed data is possible).

6.4.5.2 Report to participants related to HAM

Also in this case the SSP Operational Team sends a manual broadcast in order to inform the users about the starting and ending time of the sending for settlement.

Through the ICM (Inquiry on payments) users are able to identify which are the payments, queued for lack of liquidity, sent in the time interval indicated in the broadcast message; on the basis of the internal evidence, they are able to know which payments are already settled in region 1 and which are not yet settled in region 2.

6.4.5.3 Nature of information sent related to ASI

- The same type of notification as in normal operation, depending on the business case considered, will be sent to the AS regarding the re-settlement process.
- Furthermore, the re-settlement of transactions will entail the sending of MT 900/910 to settlement banks having opted for receiving them.
- No specific messages will be sent to notify AS and CB on the balances on the specific AS accounts (technical account, guarantee account and technical account – procedure 6 real-time). The respective AS/CB should inquire their account position via the ICM.
- Settlement banks will also have the possibility to inquire on their account position via the ICM. No specific message will be sent to them in order to report on their account position.

Reporting on AS transactions will be sent along with their re-settlement or rejection.

6.4.6 Conclusion

As stated before, the restart of region 2 is based on the bulk retrieval of SWIFTNet FIN messages (about 80% of messages). On the contrary, the retrieval of SWIFTNet FileAct and InterAct messages is not possible. Therefore, after the reconstruction process, the position of their accounts has to be checked by the participants and if necessary the participants can initiate liquidity transfers within the normal process.

In addition, some transactions are generated in an automatic way by the SSP modules. It has to be underlined that normally they will take place during start of day/end of day. In detail, these transactions are:

- Billing from CRISP to PM
- Interest and penalties from RM to PM/HAM
- Payback of overnight deposit and marginal lending and interest from SF to PM/HAM
- Interest from HAM to HAM

In case when the settlement process is interrupted by the crash of region 1 and the process result is already started in region 2, they will be automatically completed. If not, the SSP Operational Team in co-operation with SSP Technical Team will ensure its smooth performance.

7 Information and Control Module (ICM)

7.1 Overview on ICM

Basics

The Information and Control Module (ICM) equips SSP participants (credit institutions, ancillary systems, other participants and CBs) with comprehensive online information tools and easy-to-use control measures appropriate to their different business needs.

Specifically, the ICM offers the different groups of participants “single window access” to the

- Payments Module (PM)
- Static Data (Management) Module (SD)

and depending on whether the CB in question decides to use the optional services available in the SSP, participants also have access via ICM to the

- Home Accounting Module (HAM)
- Reserve Management (Module) (RM)
- Standing Facilities (Module) (SF)

Through ICM only data of the current business day are available, except for

- Information on warehoused payments that have been delivered to SSP up to five business days in advance.
- Static data information which can be entered for future dates. Static data information which has been modified or deleted is also available as “Archived” records. Only the last modified information is available this way.

In general, each SSP participant has to ask for information to be supplied (pull technology). This gives each user the flexibility to decide which information should be updated at what time. Information is displayed automatically in pop-up windows (push technology) only in exceptional circumstances (eg system broadcasts from a CB, warnings concerning payments with debit time indicator).

ICM access modes

There are two different technical modes for using the ICM.

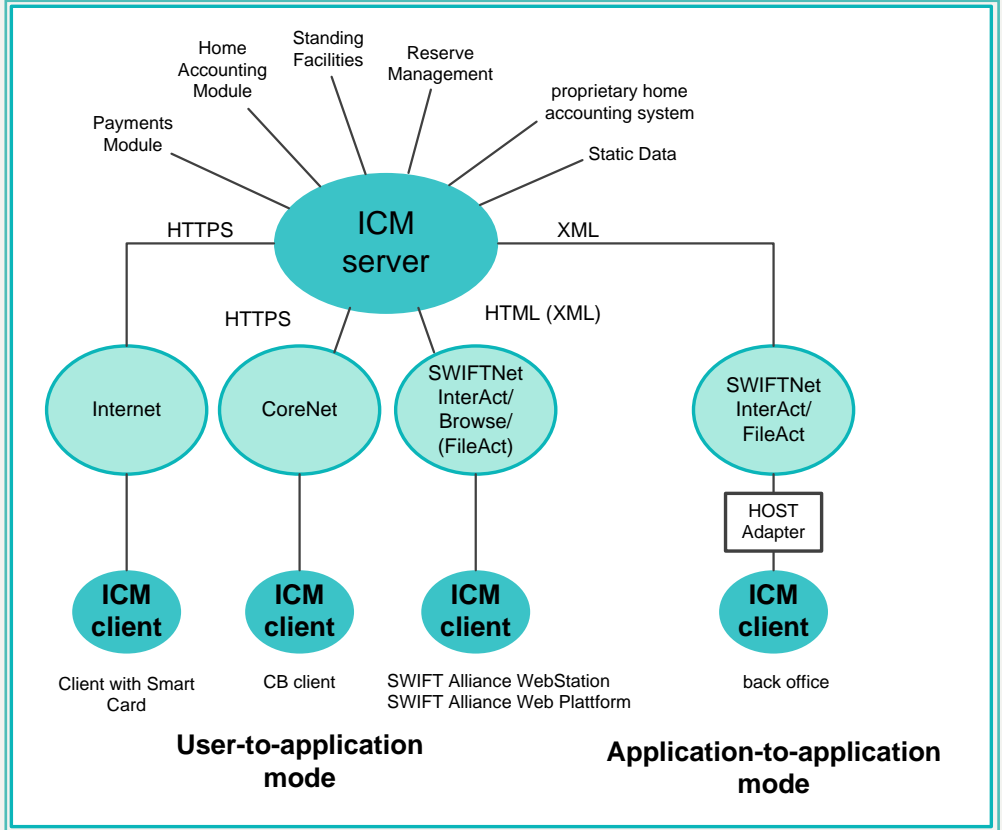

- Application-to-application mode (A2A)

Information and messages are transferred between the SSP and the individual SWIFT-based participant's internal application. Therefore, the participant must

- develop his own application,
- adapt an existing application or
- purchase an appropriate solution

in order to exchange XML messages (requests and responses) with ICM via a standardised interface. This includes the ability to deal with compressed files. However, it is not possible to decide on a case by case basis whether a file should be compressed or not. Therefore, the participant has to decide whether he wants to receive all files as compressed files or not. The algorithm used for compression is the so-called ZIP algorithm.

- User-to-application mode (U2A)

The objective is to permit direct communication between a participant's user and ICM. The information is displayed in a browser running on a PC system (SWIFT Alliance WebPlatform for SWIFT-based access or usual Internet Browser for Internet-based or CoreNet-based access). Consequently, participants do not need to develop a special application.

For the U2A access to ICM the following requirements have to be taken into account:

- Cookies and
- JavaScript must be enabled in the browser.
- Microsoft Internet Explorer is necessary for access via SWIFTNet and via CoreNet.
- Mozilla Firefox is additionally supported for access via the Internet.

Furthermore, the system requirements provided in the annex of the ICM UHB have to be taken into account.

Note:

- A2A and U2A offer almost the same functionality.
- A direct PM participant needs at least one SWIFT Alliance WebPlatform or an Internet access to have access to ICM via U2A. It is also possible that the WebPlatform is located at a service bureau.
- The A2A for monitoring functionalities defined as provision of aggregated information for CBs is not provided at the going live of the SSP.

Communication network and services for SWIFT-based access

SWIFT's Secure IP Network (SIPN) is the underlying technical communication network for the SWIFT-based access used to exchange information and to run control measures.

The following SWIFTNet services are used for the different ICM access modes.

Application-to-application mode	User-to-application mode
<ul style="list-style-type: none">• SWIFTNet InterAct• SWIFTNet FileAct	<ul style="list-style-type: none">• SWIFTNet InterAct• SWIFTNet Browse• (SWIFTNet FileAct)

Security aspects

The ICM can be used to initiate sensitive interventions by the different user groups. The ICM therefore ensures an appropriate level of security.

This is achieved by:

- the use of security features provided by SWIFT as part of the SWIFTNet services for the SWIFT-based access respectively the use of a secured Internet connection (https) and dedicated authorisation controls for the Internet-based access as well as for access via Contingency Network.
- defining different roles for the users in each group of participants (credit institutions, ASs, other participants and CBs).
- offering the “four eyes” principle as an option. Each participant can decide to which of the roles available to his users the “four eyes” principle has to apply. For security reasons, the “four eyes” principle is compulsory for some activities (eg setting up backup payments by SWIFT-based participants or issuing payments by Internet-based participants).

Note: The “four eyes” principle is not available for the A2A mode. In this case the application developed by the participant has to support the feature if necessary.

For security reasons only registered users have access to

- the information provided via the ICM.
- the management functions (control measures) that can be executed via the ICM.

To avoid the bypass of the four-eyes principle via the usage of so-called “equivalent certificates“ (one on the production site and one on the backup site) the ICM will consider the two physical certificates as one user.

Orders entered via SWIFTNet cannot be confirmed via Contingency Network and those entered via Contingency Network cannot be confirmed via SWIFTNet access.

For the user administration the service “Role Based Access Control“ (RBAC) offered by SWIFT is used. A similar role based service is used also for the Internet access and for the access via the Contingency Network.

Each participant is responsible for managing his users, meaning that he is responsible for:

- designating the users
- assigning specific roles to each user

The activities related to user management have to be executed by “Security Officers“.

Screens are offered only in English.

Detailed information on the ICM, the related screens and the user roles is provided in a separate document “ICM User Handbook I“.

User administration

ICM screens

Detailed information

7.2 ICM access

7.2.1 ICM access to PM

Basics

Access to the PM via ICM is mandatory for all direct participants in the PM (for SWIFT-based as well as Internet-based participants). This functionality is not available to indirect PM participants.

Functions available in ICM

The following non-exhaustive list gives an overview of the different functions available in ICM:

Type of information	Content
Managing the payment queue	<ul style="list-style-type: none">• View payments delivered for the current business day<ul style="list-style-type: none">– All payments– Subset of the payments according to criteria defined• View payments delivered in advance<ul style="list-style-type: none">– All payments– Subset of the payments according to criteria defined by the user• Queue management<ul style="list-style-type: none">– Revoking a non-final payment (normally not yet debited)– Changing the payment type from normal to urgent and vice versa– Moving a payment to the top or the end of the queue– Changing the time of payments with debit time indicator (Latest Debit Time Indicator, Earliest Debit Time Indicator)
Liquidity management	<ul style="list-style-type: none">• View the current liquidity position<ul style="list-style-type: none">– in RTGS account/group of accounts– in HAM– in PHA if the CB opts to continue using its proprietary

7 Information and Control Module (ICM)

- 7.2 ICM access
- 7.2.1 ICM access to PM

Type of information	Content
	<p>home accounting system and if the CB opts for an ICMPHA connection.</p> <ul style="list-style-type: none">• Liquidity management<ul style="list-style-type: none">– Transfer liquidity between the RTGS account and the home account kept either in HAM or PHA– Separation of dedicated liquidity for AS– Reservation of liquidity for the settlement process of AS• Management of standing orders from the home account kept either in HAM or PHA to the RTGS account

7 Information and Control Module (ICM)

- 7.2 ICM access
- 7.2.1 ICM access to PM

Type of information	Content
Management of reservation and limits	<ul style="list-style-type: none">• Management of the reserves and limits for the current business day<ul style="list-style-type: none">– Highly urgent reserves– Urgent reserves– Bilateral limits– Multilateral limit• Management of the standing order reserves and limits for the next business days<ul style="list-style-type: none">– Highly urgent reserves– Urgent reserves– Bilateral limits– Multilateral limit
Information management	<ul style="list-style-type: none">• View the system broadcasts sent by the CBs during a business day• View the system status<ul style="list-style-type: none">– Cut-off times in the PM– Status of AS• Access to directory services<ul style="list-style-type: none">– View the TARGET2 directory
Emergency tool (only for SWIFT-based direct participants)	<p>Creating backup payments in favour of</p> <ul style="list-style-type: none">• PM participants• CLS• EURO01• STEP2

7.2.2 ICM access to SD

The following table summarises which functions are available to users to access static data information in application-to-application mode and user-to-application mode. Some of these functions are only available in case the optional modules are used.

Data	Function	U2A	A2A
Legal entities	Select Legal Entities	X	X
	DisplayLegal Entity	X	X
Participants	Select Participant	X	X
	DisplayParticipant	X	X
	DisplayTARGET2 WildCard	X	X
	List of Ancillary System used	X	
	DisplayRTGS Account	X	X
	DisplayList of linked DCAs	X	
	DisplayTIPS Account	X	
	DisplayDirect Debit	X	X
	Select Sub-Account	X	X
	DisplaySub-Account	X	X
	Select Co-Managed Accounts	X	X
	DisplayHAM Account	X	X
	DisplaySF Account	X	X
Ancillary system	Select Ancillary System	X	X
	DisplayAncillary System	X	X

Basics

Functions available in ICM

7 Information and Control Module (ICM)

- 7.2 ICM access
- 7.2.2 ICM access to SD

Data	Function	U2A	A2A
	Select Ancillary System Settlement Banks	X	X
	Select Counterpart Ancillary System	X	
Central banks	Select Central Bank	X	X
	Display Central Bank	X	X
Contact item	Select Contact Item	X	X
	Display Contact Item	X	X
TARGET2 Dir	Select TARGET2-Dir	X	
	Display TARGET2-Dir	X	
Group of ac- counts	Select Group of Accounts	X	X
	Display Group of Accounts	X	X
Matching Table DN-BIC	Select DN	X	
Error codes	Select Error Codes	X	X
Calendar	Display Calendar	X	X
Events	Select Events	X	X
Rates	Select Rates	X	

Note: For provisioning the TARGET2 directory for SWIFT-based participants, the generic functionality of the SWIFTNet FileAct service is used. For Internet-based participants the TARGET2 directory can only be displayed via ICM.

7.3	User roles for ICM access
7.3.1	Two eyes/four eyes principle

7.3 User roles for ICM access

7.3.1 Two eyes/four eyes principle

There are defined roles using the two eyes principle and others using the four eyes principle.

With the access to ICM more than one user role may be transmitted to ICM. If for the same functional role the role for two eyes principle and four eyes principle are transmitted in parallel the four eyes principle is relevant for the further processing.

Transactions inserted via user role with two eyes principle normally do not need a verification. Regardless of the user role some functions may impose a mandatory verification by a second user. This applies for payments inserted via ICM, such as payments sent from an Internet-based participant or backup payments.

Transactions inserted via a user role with four eyes principle usually need a verification by another user with a user role with two or four eyes principle. But a four eyes principle is not applicable to the capturing of a link to a TIPS account in participant screen, even if a four eyes role is used.

The access solution supports the equivalent certificates notation. This means that in case of existing two physical certificates for the very same user (eg one for the production site and another one for the backup site) these are considered as one user within the ICM.

The chains of transactions are as follows:

Transaction	Steps of different scenarios (1 - 6)					
	1	2	3	4	5	6
inserting or changing data with two eyes principle	1					
inserting or changing data with four eyes principle		1	1	1	1	1

- 7.3 User roles for ICM access
 7.3.1 Two eyes/four eyes principle

Transaction	Steps of different scenarios (1 - 6)					
	1	2	3	4	5	6
changing of the insert/change during the verification with two eyes principle				2		
changing of the insert/change during the verification with four eyes principle (same or other user than the inserting one)					2	2
verifying with two eyes principle (other user than the inserting one)		2			3*	
verifying with four eyes principle (other user than the inserting one)			2			3*

Remark:

* It can also be the user who did step 1.

Example for scenario 5:

A user changes the standing order bilateral limits via the screen Display and Enter Standing Order Limits and has the user role for 4-eyes-principle (step 1). This change has to be validated by a second user. A second user also with the user role for 4-eyes-principle wants to control the change but recognises an error. He corrects this error immediately (step 2). Due to this additional change a further user (it also may be the user who did step 1) has to validate the change. This further user confirms the change (step 3).

Note:

- After the user has changed the standing order bilateral limits, a warning in ICM displays the message "Info Task in status "To confirm" is visible in the Task Queue of the SD Module". The same kind of warnings are displayed for the other Standing Order types and some functions in the Display Participant screen.

- The control in case of four eyes principle is possible via the Display screen. If the user is allowed to control, then he gets the additional buttons „Confirm“, „Revoke“ and „Edit“.
- A revocation of a task is possible for CB users independent from the user group profile of the initiator.
- The information on open transactions in the task queue will be available not only for the initiator but also for the central bank (it will be possible for the central bank to indicate the BIC of the initiator in order to have access to the information).

7.3.2 User roles in A2A

Basics

For information about the user roles for credit institutions and ancillary systems A2A, see chapter 2.8.1.2 of the UDFS, book 4.

7.3.3 User roles in U2A

Basics

A set of user roles will be offered to the SSP participants in the U2A approach. It will allow them

- to share the duties between different persons quite flexible
- to have a strict segregation of duties
- to opt for the four-eyes principle at the level of a single user

The range of selections a security officer has for assigning the specific user roles to each user depends on

- the type of the respective participant, ie
 - Direct PM participant
 - HAM account holder
 - Ancillary system (for the access of an ancillary system via the Ancillary Systems Interface no user role is required)
 - Collateral manager

7 Information and Control Module (ICM)

7.3 User roles for ICM access

7.3.3 User roles in U2A

- the choice the pertaining central bank has made concerning the optional modules of the SSP (HAM, RM, SF)

There are two main types of user roles:

- User roles which are only allowed to read data
- User roles which are allowed both to read and to modify data

Internet-based access

The Internet access of Internet-based participants is based on the U2A approach. There will be only one role for reading and modifying access available for two and for four eyes principle.

User roles with reading access

In general, every user has the right to read all information which is required for his respective activities. All user roles with reading access are only available in two eyes principle. The following table provides an overview of

- all user roles for SSP participants which are only allowed to read data
- the kind of data the respective user role is allowed to read

User role name	Description	Reading access to
ASINFOTE	AS Read Information	All dedicated information for AS
CURCOMTE	CU Reader Co-Management	Information concerning co-managed accounts
CURGOATE	CU GoA Reader	Information concerning accounts which belong to the group of accounts
CUINFOTE	CU Reader	All dedicated information for the respective registered participant with exception of information related to co-management. Concerning group of accounts, access is only partly possible.

User roles with reading and modifying access

All user roles with reading and modifying access are characterized by the extent of authorization for actions

7 Information and Control Module (ICM)

7.3 User roles for ICM access

7.3.3 User roles in U2A

- in the different ICM menu items and screens on their own behalf
- via Profile Selection for another SSP participant

The following, non-exhaustive list gives an overview of

- all user roles for SSP participants which are allowed to read and to modify data
- the availability of the user roles in the two eyes principle/four eyes principle. In case of four eyes principle the confirmation of a task by a second user is required
- the specific actions in the respective ICM menu items which characterize the respective user role

User role name	Description	Menu item	Two eyes/ four eyes principle	Specific actions
ASMANATE ASMANAFE	AS Manager	RTGS	Two eyes principle and four eyes principle	Access to AS related functions including <ul style="list-style-type: none"> • Start/Stop of cycle/procedure • Change of settlement periods
CUBAUPFE	CU Back up Manager	RTGS	Four eyes principle only	Entry of back up payments <ul style="list-style-type: none"> • CLS • EURO1 • STEP2 • One direct PM participant • List of favourites
CUCOMATE CUCOMAFE	CU Co- Manager	Home Account- ing	Two eyes principle and four eyes principle	For the co-managed: <ul style="list-style-type: none"> • Entry of liquidity transfers (other accounts) • Modification of reservations for cash withdrawals

7 Information and Control Module (ICM)

7.3 User roles for ICM access

7.3.3 User roles in U2A

User role name	Description	Menu item	Two eyes/ four eyes principle	Specific actions
		Services		For the co-managed: Entry of liquidity transfers in the context of Overnight Deposits
CUGAMATE CUGAMAFE	CU GoA Manager	RTGS	Two eyes principle and four eyes principle	<p>Management of the single payment queue for the respective group of accounts (virtual account)</p> <ul style="list-style-type: none"> • Change the priority of a payment • Change the execution time of a payment • Increase a payment • Decrease a payment • Revoke a payment <p>Entry of current liquidity transfers (virtual account and consolidated information):</p> <ul style="list-style-type: none"> • between RTGS accounts • between RTGS account and sub-account (via Profile Selection for a group member) • to AS technical accounts – procedure 6 – real-time (via Profile Selection for a group member) <p>Entry of current limits (virtual account)</p> <ul style="list-style-type: none"> • Bilateral limits • Multilateral limit <p>Entry of standing order limits (virtual account)</p>

7 Information and Control Module (ICM)

7.3 User roles for ICM access

7.3.3 User roles in U2A

User role name	Description	Menu item	Two eyes/ four eyes principle	Specific actions
				<ul style="list-style-type: none"> • Bilateral limits • Multilateral limit Entry of current reservations (virtual account) <ul style="list-style-type: none"> • Urgent • Highly urgent Entry of standing order reservations (virtual account) <ul style="list-style-type: none"> • Urgent • Highly urgent
CULIMITE CULIMIFE	CU Limit Manager	RTGS	Two eyes principle and four eyes principle	Entry of current limits (except for virtual account): <ul style="list-style-type: none"> • Bilateral limits • Multilateral limit Entry of standing order limits (except for virtual account) <ul style="list-style-type: none"> • Bilateral limits • Multilateral limit
CULIQUITE CULIQUFE	CU Liquidity Manger	RTGS	Two eyes principle and four eyes principle	Entry of current liquidity transfers between <ul style="list-style-type: none"> • RTGS account and HAM/PHA account • RTGS account and subaccount • RTGS account and technical account – procedure 6 – real-time (to the technical account – procedure 6 – real-time only) • RTGS account and T2S Dedi-

7 Information and Control Module (ICM)

7.3 User roles for ICM access

7.3.3 User roles in U2A

User role name	Description	Menu item	Two eyes/ four eyes principle	Specific actions
				<p>cated Cash Account (from T2S Dedicated Cash Account to RTGS account is only enabled in case of using value added services)</p> <ul style="list-style-type: none"> • RTGS account and TIPS account (both directions) <p>Entry of standing order liquidity transfers from</p> <ul style="list-style-type: none"> • HAMPHA account to RTGS account • RTGS account to subaccount/technical account – procedure 6 – real-time • RTGS to DCAs • RTGS to TIPS account
		Services		Entry of liquidity transfers in the context of Overnight Deposits
CUPAYMTE CUPAYMFE	CU Payment Manger	RTGS	Two eyes principle and four eyes principle	<p>Management of the payment queue:</p> <ul style="list-style-type: none"> • Change the priority of a payment • Change the execution time of a payment • Increase a payment (except for virtual account) • Decrease a payment (except for virtual account) • Revoke a payment
CURMANTE CURMANFE	CU Reservation Manag-	RTGS	Two eyes principle and	Entry of current reservations (except for virtual account)

7 Information and Control Module (ICM)

7.3 User roles for ICM access

7.3.3 User roles in U2A

User role name	Description	Menu item	Two eyes/ four eyes principle	Specific actions
	er		four eyes principle	<ul style="list-style-type: none"> • Urgent • Highly urgent Entry of standing order reservations (except for virtual account) <ul style="list-style-type: none"> • Urgent • Highly urgent
HAMANATE HAMANAFE	HAM/SF/RM Manager	RTGS	Two eyes principle and four eyes principle	Entry of standing order liquidity transfers from HAM to RTGS account
		Home Accounting		Execution of all modification actions in all types of liquidity transfers envisaged Modification of reservations for cash withdrawals
		Services		Entry of liquidity transfers in the context of Overnight Deposits
LVMANATE LVMANAFE	Internet-based participant Manager (special role for Internet-based participants)	RTGS	Two eyes principle and four eyes principle	Entry of payments to other direct participants (MT 103(+)/202 (COV)) (four eyes principle only!) Entry of current limits: <ul style="list-style-type: none"> • Bilateral limits • Multilateral limit Entry of standing order limits <ul style="list-style-type: none"> • Bilateral limits • Multilateral limit

7 Information and Control Module (ICM)

7.3 User roles for ICM access

7.3.3 User roles in U2A

User role name	Description	Menu item	Two eyes/ four eyes principle	Specific actions
				<p>Entry of current liquidity transfers between</p> <ul style="list-style-type: none"> • RTGS account and HAM/PHA account • RTGS account and subaccount • RTGS account and technical account – procedure 6 – real-time (to the technical account – procedure 6 – real-time only) <p>Entry of standing order liquidity transfers from</p> <ul style="list-style-type: none"> • HAM/PHA account to RTGS account • RTGS account to subaccount/technical account – procedure 6 – real-time <p>Management of the payment queue:</p> <ul style="list-style-type: none"> • Change the priority of a payment • Change the execution time of a payment • Increase a payment • Decrease a payment • Revoke a payment <p>Entry of current reservations</p> <ul style="list-style-type: none"> • Urgent • Highly urgent <p>Entry of standing order reservations</p>

7 Information and Control Module (ICM)

7.3 User roles for ICM access

7.3.3 User roles in U2A

User role name	Description	Menu item	Two eyes/ four eyes principle	Specific actions
				<ul style="list-style-type: none">• Urgent• Highly urgent Entry of standing order liquidity transfers from HAM to RTGS account
		Home accounting		Execution of all modification actions in all types of liquidity transfers envisaged Modification of reservations for cash withdrawals
		Services		Entry of liquidity transfers in the context of Overnight Deposits

8 Enhanced Contingency Solution (ECONS I) - User Handbook

8.1 Business approach of ECONS I

Basics

The **Enhanced Contingency Solution (ECONS I)** is equipped with online information tools and easy-to-use control measures, which can be used directly by CBs, **direct PM participant and for monitoring purpose by Ancillary Systems**, based on the same concept of the Information and Control Module.

ECONS I access modes

The same technical modes used for the ICM are available for using the **ECONS I**.

- Application-to-application mode **for CBs only**
- User-to-application mode

Communication network and services

SWIFT's Secure IP Network (SIPN) is the underlying technical communication network used to exchange information and to run control measures.

The following SWIFT services are used for the different **ECONS I** access modes.

Application-to-application mode	User-to-application mode
<ul style="list-style-type: none">• SWIFTNet InterAct	<ul style="list-style-type: none">• SWIFT WebAccess

For the access to the **ECONS I** the same infrastructure as used for the ICM is needed. A specific URL has to be used to access the **participant** browse functionality.

ECONS I screens

Detailed information on the ECONS I functionalities and the related screens are provided in a separate document as annex to the UDFS.

Screens are offered only in English.

8.2 Functions available in ECONS I

Access to ECONS I is mandatory for all Eurosystem CBs via U2A and/or A2A. Other participants can connect only via U2A.

This module can be used for a number of consecutive days (up to 5) with the possibility to close the business day, to process critical and very critical payments. It is always at the discretion of the CBs to determine which payments will be processed in the ECONS I; a CB is able to agree/disagree (via U2A) the processing of each payment inserted by the participants; it only supports "straight forward payment processing" (no queuing mechanism is in place); the Enhanced Contingency Solution supports processing of AS files (kind of settlement procedure 4) uploaded by CBs on behalf of the Ancillary System in A2A mode (no agree/disagree functionality in this case).

Note: The following list gives a partial overview of the functions available in ECONS I:

Type of information	Content
Change status	<ul style="list-style-type: none"> • Active contingency • Close contingency
Liquidity management	<ul style="list-style-type: none"> • Credit line (liquidity injection from the CB) • Payments instruction • Ancillary System files
Account position	<ul style="list-style-type: none"> • Account balance
Transactions processing	<ul style="list-style-type: none"> • Transaction details (creditor, debtor, value, type of payment) • Status of transactions
Status of the system	<ul style="list-style-type: none"> • Status of the contingency ("open", "closing", "closed")

Basics

Functions

The four-eyes principle is offered as an option. This option is not available for the application-to-application mode. In this mode the application developed by the participant has to support this feature (if needed).

9 Technical Specifications

- 9.1 SWIFTNet FIN related issues
- 9.1.1 SWIFTNet FIN - General aspects

9 Technical Specifications

9.1 SWIFTNet FIN related issues

9.1.1 SWIFTNet FIN - General aspects

9.1.1.1 Business Identifier Codes (BICs) for SSP

Overview

The SSP uses several BICs for different purposes. The following diagram gives an overview of all BICs (SSP core and optional modules):

9 Technical Specifications

- 9.1 SWIFTNet FIN related issues
- 9.1.1 SWIFTNet FIN - General aspects

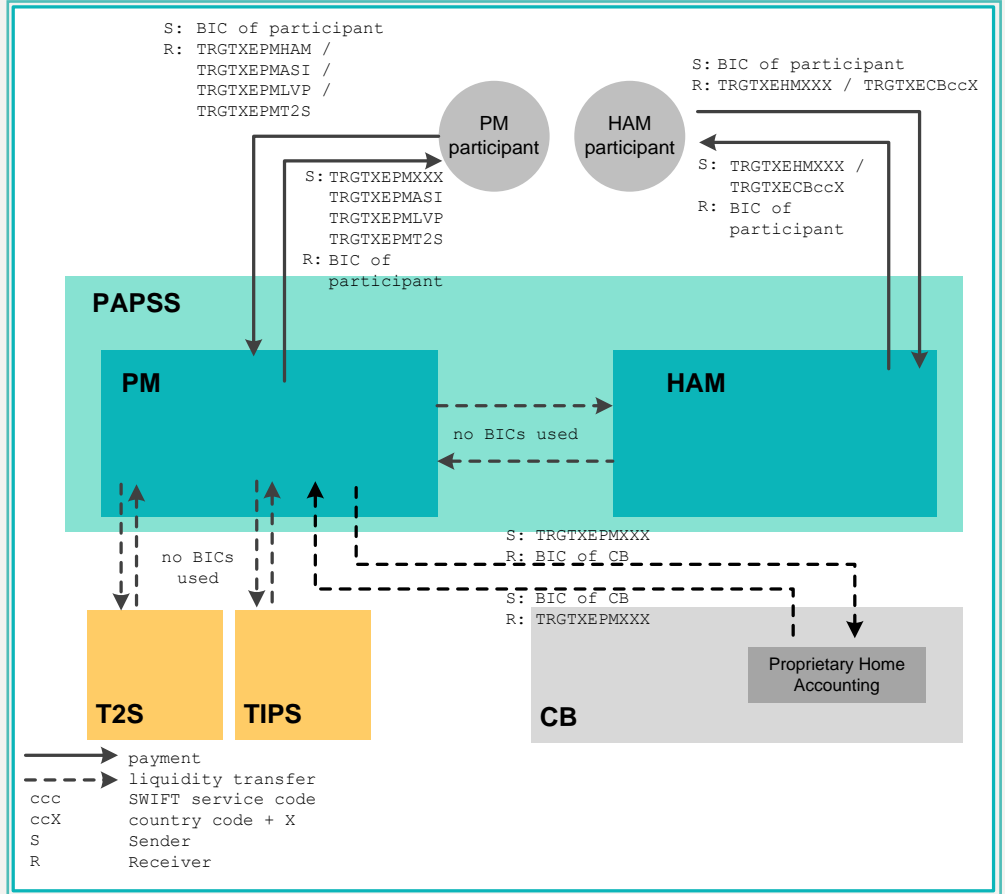

FIN Copy Service Profile

Parameter	Value
FIN Copy Service Code	TGT
Service Administration Destination	TRGTXEPM
Authentication mode (normal=1, double=2)	2
Full copy flag (full copy=Y, partial copy=N)	Y

9 Technical Specifications

- 9.1 SWIFTNet FIN related issues
- 9.1.1 SWIFTNet FIN - General aspects

Parameter	Value
Y-copy Sender Notification (MT 012) (G=Global, I=Individual, N=None)	I
----	----
FIN Copy Service Mode	Y-copy
FIN Copy fallback service	Close the service
FIN Copy Server Destination - Primary	TRGTXE2M
FIN Copy Server Destination - Secondary	TRGTXE3M

FIN Copy message restrictions

The table below shows the restriction applicable to the messages exchanged within the TGT Y-copy service as defined with SWIFT. For messages different than Y-copy standard RMA applies.

FIN Copy Message restrictions		
Send/Receive	FIN Copy user/PM user	FIN Copy Administrator (TRGTXEPM)
FIN Copy user/PM user	<ul style="list-style-type: none"> • To be copied: 103 – 202 - 204 • Not to be copied: 999, 191, 192, 195, 196, 199, 291, 292, 295, 296, 299 	999 - 199 - 299
FIN Copy Administrator (TRGTXEPM)	900, 910, 202, 103, 999, 199, 299	Not applicable
FIN Copy Administrator 2 (TRGTXE2M - TRGTXE3M)	940, 950	

9 Technical Specifications

- 9.1 SWIFTNet FIN related issues
- 9.1.1 SWIFTNet FIN - General aspects

BICs of PM

The following table lists the different purposes and the BICs used:

Purpose	BIC	Usage	Maintenance
Sending of messages directly from PM to PM participants	TRGTXEPMXXX	Used as sender in the SWIFT header for all messages sent directly from PM to PM participants using SWIFTNet FIN (no Y-copy!): <ul style="list-style-type: none"> • MT 900 • MT 910 • MT 202 (Backup payment) • MT 202 (Liquidity transfer from PM to proprietary home accounting system) 	permanent
Sending of MT 940/950 from PM to PM participants	TRGTXE2MXXX or TRGTXE3MXXX	Used as sender in the SWIFT header; for technical reasons the account statements are sent out to the participants by two different BICs.	permanent
Incoming liquidity transfers from proprietary home accounting systems	TRGTXEPMXXX	Used as receiver in the SWIFT header for payments (liquidity transfers) exchanged between proprietary home accounting systems and PM.	permanent
Liquidity transfer from one PM participant to another PM participant	TRGTXEPMXXX	Used as receiver in the SWIFT header of MT 202 (liquidity transfers). Ordering institution in field 52 is equal to the beneficiary institution in field 58 (ie creditor).	permanent
Incoming fund transfer from a PM participant to	TRGTXEPHAM	Used as receiver in the SWIFT header for payments (fund transfers) exchanged between a PM	permanent

9 Technical Specifications

- 9.1 SWIFTNet FIN related issues
- 9.1.1 SWIFTNet FIN - General aspects

Purpose	BIC	Usage	Maintenance
HAM		participant and a HAM account holder.	
Liquidity transfer via ASI	TRGTXEPMASI	Used as sender/receiver in the SWIFT header for liquidity transfers exchanged between a participant and an ancillary system (AS).	permanent
Liquidity transfer via T2S	TRGTXEPMT2S	Used as sender/receiver in the SWIFT header for liquidity transfers exchanged between a participant and T2S. Note: The MT 202 is part of value added services the participant must have opted for. In account statements MT940/MT950 incoming liquidity transfers from T2S are listed with BIC TRGTXEP-MBAH in field 61, subfield 9.	permanent
Payments from or to an Internet-based direct participant	TRGTXEPLVP	Used as sender/receiver in the SWIFT header for Y-copy payments exchanged between a SWIFT-based participant and an Internet-based direct participant.	permanent
Sending of MT 940/950 from ECONS I to PM participants	TRGTXEPMCON	Used as sender in the SWIFT header for MT 940/950 sent from ECONS I to PM participants.	permanent

9 Technical Specifications

- 9.1 SWIFTNet FIN related issues
- 9.1.1 SWIFTNet FIN - General aspects

BICs of HAM

The following table lists the different purposes and the BICs used:

Purpose	Proposed BIC	Usage	Maintenance
Messages sent from/received by HAM participants	TRGTXEHMXXX	Used when FIN messages are sent/received by this module via SWIFTNet FIN. In the header of the following SWIFT messages sent by the HAM this BIC will be used as sender/receiver: <ul style="list-style-type: none"> • MT 202 simplified • MT 900 • MT 910 • MT 940 • MT 950 	permanent
Payments from HAM to PM and vice versa for CB customer payments	TRGTXECBccX	ccX: country code + "X" of the different central banks Used as: <ul style="list-style-type: none"> • Receiver in the HAM for the payments send by the CB customer. • Sender in the HAM for the notification of the payments received from PM participants. • Sender/receiver in the messages exchanged between HAM and PM for the CB customer traffic 	permanent; member of the PM Y-copy CUG

- 9.1 SWIFTNet FIN related issues
- 9.1.1 SWIFTNet FIN - General aspects

BICs used by CBs

The following table lists the different purposes and the BICs used:

Purpose	Usage	Maintenance
BICs for proprietary home accounting systems	These BICs do not need to be changed. It is up to each CB keeping a proprietary home accounting system to decide whether the old BIC should remain valid or a new BIC should be used.	permanent

Usage of the format D in bank fields

TARGET2 supports the use of STP rules envisaging the use of format A for all bank fields. Nevertheless, in order to avoid operational difficulties for the processing of payments coming from/sent to outside the EU the use of format D is allowed in specific fields.

9.1.1.2 Public Key Infrastructure (PKI)

Use of PKI in the SSP environment

The SSP uses the core PKI provided by SWIFT, no additional information is be provided in the User Detailed Functional Specifications. All information needed is available in the documentation provided by SWIFT.

The SWIFTNet FIN access control and user-to-user security mechanisms is based on PKI while the relationship management capability is based on the Relationship Management Application (RMA) service on a BIC8 basis. Considering that the Closed User Group feature can effectively prevent unsolicited traffic and in order to reduce the operational burden for the users, the bilateral relationships provided by the RMA is not be requested for the user to user messages MT 103/202/204 in the FIN Copy service for TARGET2 (RMA by-pass). Like for the BKE, RMA bilateral relationships are necessary vis-à-vis the SSP BICs, therefore, in order to properly manage all the aspects of the FIN security for TARGET2 the users have to exchange the SWIFT RMA between their BIC8 and the SSP BICs both in live and T&T environments depending on the used modules.

- 9.1 SWIFTNet FIN related issues
- 9.1.1 SWIFTNet FIN - General aspects

RMA policy

The following rules are applicable for the RMA exchange with the SSP:

	Live	T&T
SSP Correspondent BIC	TRGTXEPM	TRGTXEP0
Signing BIC for T&T	-	TRGTXEPM
SWIFT Service	swift.fin	swift.fin!p
Frequency of exchange	Permanent authorisation	Permanent authorisation
Granularity	All message category/type	All message category/type
Type of RMA	both send/receive	both send/receive

9.1.1.3 SWIFTNet FIN messages

9.1.1.3.1 Structure

General

SWIFTNet FIN messages are structured in blocks. Each block of a message contains a special type of data.

Definition of the structure of blocks

Each block begins and ends with a brace ({}). The first two characters in a block are its number and the separator (:).

A SWIFT message therefore has the following structure:

- {1: Basic Header Block}
- {2: Application Header Block}
- {3: User Header Block}
- {4: Text Block}
- {5: Trailer}

9 Technical Specifications

- 9.1 SWIFTNet FIN related issues
- 9.1.1 SWIFTNet FIN - General aspects

Building up of header and trailer

Header and trailer are always build up following the same schema. For the different message types they differ only slightly.

The building up of the header and trailer is described in chapter [9.1.2 SWIFTNet FIN Messages - Details, page 418](#).

The specific message is contained in the text block. It is described for each message type in a separate chapter.

9.1.1.3.2 Formatting rules for fields

General

For describing the message formats (for using the SSP core modules) in this document the same conventions as in the SWIFT User Handbooks are used. The individual fields are specified by their length and the permitted contents.

Specification of the field length

The following table summarizes the display formats for the field length:

Field length	Meaning
n	Maximum n characters
n!	Exact n characters
n * m	n lines at a maximum of m characters each

Specification of the field content

The following table summarizes the display formats of the field contents:

Field content	Meaning
n	Digits from 0 to 9
a	Capital letters from A to Z
x	Any character of the SWIFT character font, capital and small letters

- 9.1 SWIFTNet FIN related issues
- 9.1.2 SWIFTNet FIN Messages - Details

Field content	Meaning
c	Capital letters from A to Z, and digits between 0 and 9
d	Digits from 0 to 9 and comma for showing currency amounts
h	Hexadecimal number: Digits from 0 to 9 and capital letters from A to F

Optional field contents are shown in brackets (eg [34x]).

Field status

The following table summarizes the display formats for the field status:

Status	Meaning
M	Mandatory field
O	Optional field
---->	Repetitive sequence in a message. The following fields may appear several times (up to a given maximum).
----	End of the repetitive sequence

9.1.2 SWIFTNet FIN Messages - Details

9.1.2.1 Header and Trailer

9.1.2.1.1 Header

9.1.2.1.1.1 Basic Header

Usage

The basic header is used in every message type sent to or received from the SSP.

Structure

The basic header has the following structure:

Basic Header			
Status	Field name	Format	Use in SSP
M	Block Identifier	1:	-
M	Application Identifier	F	F = FIN
M	Service Identifier	01	-
M	LT Address	4!a2!a2!c1!c3!c	BIC+LT, 12 digits Message from participant to FIN: <ul style="list-style-type: none"> • Sender's LT address Message from FIN to participant: <ul style="list-style-type: none"> • Receiver's LT address
M	Session Number	4!n	-
M	Sequence Number	6!n	-

9.1.2.1.1.2 Application Header

Usage

The application header is used in every message type sent to received from the SSP. It has different formats depending on whether the participant delivers a message to, or receives one from the SWIFT network.

9 Technical Specifications

- 9.1 SWIFTNet FIN related issues
- 9.1.2 SWIFTNet FIN Messages - Details

Structure when sending a message

The following table describes the structure of the application header (except application header for HAM - optional module) when a participant sends a message to the SWIFT network. (It is an outgoing payment from the participant's point of view.)

Application Header			
Status	Field name	Format	Use in SSP
M	Block Identifier	2:	-
M	Input/Output Identifier	I	I = Input for SWIFT
M	Message Type	3!n	103, 202, 204
M	Destination Address	4!a2!a2!c1!c3!c	BIC+LT, 12 digits <ul style="list-style-type: none"> • (Receiver's LT address) Message to PM participant: <ul style="list-style-type: none"> • Receiving bank Message to proprietary home accounts kept by a CB in its proprietary home accounting system: <ul style="list-style-type: none"> • BIC of the CB
M	Message Priority	N or U	PM: Not relevant!
O	Delivery Monitoring	1!n	-
O	Obsolescence Period	3!n	-

Structure when receiving a message

The following table describes the application header when the participant receives the message from the SWIFT network. (It is an incoming message from the participant's point of view.)

Application Header		
Field name	Format	Use in SSP
Block Identifier	2:	-
Input/Output Identifier	O	O = Output for SWIFT
Message Type	3!n	012, 019, 103, 202, 204, 900, 910, 940, 950
Input Time	HHMM	Input time
Message Input Reference	6!n4!a2!a2!c1!c3!c4!n6!n	Input date, local to the sender, LT address of sender, session and sequence number of sender
Date	YYMMDD	Output date, local to the receiver
Time	HHMM	Output time, local to the receiver
Message Priority	N, U or S	N or U = sender's message priority S = system (MT 012 and MT 019)

9.1.2.1.1.3 User Header

Usage

The user header is basically optional, but it is used in all message types of SSP.

It has a different format depending on whether the participant delivers a message to, or receives one from the SWIFT network. Every field in the user header is put in braces ({}).

Note: The individual fields are described in detail in the SWIFT User Handbook "FIN System Messages".

9 Technical Specifications

- 9.1 SWIFTNet FIN related issues
- 9.1.2 SWIFTNet FIN Messages - Details

Structure when sending a message

The following table describes the user header when the participant sends the message to the SWIFT network (It is an outgoing payment from the participant's point of view):

User Header				
Status	Tag	Field name	Content/Options	Use in SSP
M	-	Block Identifier	3:	-
M	103	Service Code	{103:3!a}	PM: TGT = Code for the FIN Copy Service of the SSP If this field is not present, the message will be delivered directly to the receiver without processing in the Payments Module (PM).
O	113	Banking Priority	{113:4!x}	Character 1: H = highly urgent payment U = urgent payment N = normal payment Character 2: Y = MT 012 requested N = MT 012 not requested Flag will be ignored and a MT 012 will always be returned, if the message is addressed to TRGTXPMT2S for initiation of a pull liquidity transfer from T2S and if the payment is only partially executed by T2S. So this important information is always reported via an MT 012. Character 3 + 4: see note If character 2 has been given "N", character

9 Technical Specifications

- 9.1 SWIFTNet FIN related issues
- 9.1.2 SWIFTNet FIN Messages - Details

User Header				
Status	Tag	Field name	Content/Options	Use in SSP
				<p>1 must be filled with "H", "U" or "N", otherwise the default value "NYNN" will be set.</p> <p>If the field is not available, SSP treats this payment as a normal payment and the sender receives an MT 012 (equivalent to value "NYNN").</p> <p>In messages addressed to TRGTXEPMT2S this field with character 1 = "H" is mandatory. (Liquidity transfers to T2S are always highly urgent.)</p> <p>Character 1 can be entered by the IBP (U or N). All other characters are not available and will be set to "N" in the outgoing Y-copy message sent by PM.</p>
O	108	Optional Message User Reference	{108:16x}	Field is not available for Internet-based participants as this field is used by PM to match the incoming MT 096 from SWIFT (derived from the sent Y-copy message) to the ICM order (entered by the Internet-based participant in the ICM screens).

9 Technical Specifications

- 9.1 SWIFTNet FIN related issues
- 9.1.2 SWIFTNet FIN Messages - Details

User Header				
Status	Tag	Field name	Content/Options	Use in SSP
O	119	Validation Flag	{119:8c}	<p>Use in MT 103: The SWIFT-based participant may request SWIFT validation according to the rules of the MT 103+ by using {119:STP}. If this field is not available, MT 103 core will follow.</p> <p>Use in MT 202 COV: The placement of field 119 with code COV is mandatory. {119: REMIT} is not allowed in SSP.</p> <p>In case of payments from Internet-based participants the validation flag will be assigned by the usage of the respective screen (dedicated screens for MT 103, MT 103+, MT 202 and MT 202 COV are provided).</p>
O	111	Service type identifier	{111:3!n}	<p>This field identifies the applicable global payment service type.</p> <p>PM: Use in MT 103, MT 103+, MT 202, MT 202 COV.</p> <p>HAM: Use in MT 103, MT 103+, MT 202, MT 202 COV. This field is accepted but not forwarded.</p> <p>Note: Sender must be member of GPI closed user group when populating field 111.</p>
M	121	Unique end-to-end trans-	{121:36!x}	<p>This field provides an end-to-end reference (UETR) across a payment transaction. All</p>

9 Technical Specifications

- 9.1 SWIFTNet FIN related issues
- 9.1.2 SWIFTNet FIN Messages - Details

User Header				
Status	Tag	Field name	Content/Options	Use in SSP
		action reference (UETR)		<p>SWIFT users (also non-GPI) will need to populate field 121 when creating new outbound FIN payments. In addition the received field 121 must be forwarded to the next bank in the transaction chain.</p> <p>PM: Use in MT 103, MT 103+, MT 202, MT 202 COV</p> <p>HAM: Use in MT 103, MT 103+, MT 202, MT 202 COV.</p>

Note: The third and fourth characters of the field 113 are not used (and not checked by the SSP). Based on an agreement at national level they can be used to support specific needs like the indication that in the payment message the ordering and/or the beneficiary are non-resident in the country of the sender (regular reporting purposes).

Note: Field 121 must follow SWIFT specifications: xxxxxxxx-xxxx-4xxx-yxxx-xxxxxxxxxxxx where x is any hexadecimal character (lower case only) and y is one of 8, 9, a or b.

The following table describes the user header when the participant receives the message from the SWIFT network. (It is an incoming message from the participant's point of view.)

User Header			
Tag	Field name	Content/Options	Use in SSP
-	Block Identifier	3:	

Structure when receiving a message

9 Technical Specifications

- 9.1 SWIFTNet FIN related issues
- 9.1.2 SWIFTNet FIN Messages - Details

User Header			
Tag	Field name	Content/Options	Use in SSP
103	Service Code	{103:TGT}	<p>PM: TGT = code for SSP in MT 103, 103+, 202, 202 COV, 204 Stating "TGT" is synonymous with settling payments via Payments Module (PM). All other MT will not contain field 103.</p>
113	Banking Priority	{113:4!x}	Banking priority as set by the sender of the message. It can be ignored by the receiver. MT 012, 019, 900, 910, 940, 950 will contain no field 113.
108	Optional Message User Reference	{108:16x}	Only present when filled by the sender of the message.
111	Service type identifier	{111:3!n}	<p>This field identifies the applicable global payment service type.</p> <p>PM: Use in MT 103, MT 103+, MT 202, MT 202 COV.</p> <p>HAM: HAM does not forward this field even if it is present in the message sent to HAM.</p> <p>Note: Participants must be able to receive field 111 even if they are no member of the GPI closed user group.</p>

9 Technical Specifications

- 9.1 SWIFTNet FIN related issues
- 9.1.2 SWIFTNet FIN Messages - Details

User Header			
Tag	Field name	Content/Options	Use in SSP
121	Unique end-to-end transaction reference (UETR)	{121:36!x}	<p>This field provides an end-to-end reference (UETR) across a payment transaction.</p> <p>PM: Use in MT 103, MT 103+, MT 202, MT 202 COV, MT 204.</p> <p>HAM: Use in MT 103, MT 103+, MT 202, MT 202 COV.</p> <p>Note: Field is always present in above-mentioned message types received by participants. PM and HAM will forward the original UETR of incoming message. In case no incoming message exists (eg initiated via ICM U2A) or UETR is not present (in exceptional cases), PM and HAM will generate the UETR automatically.</p>
119	Validation Flag	{119:8c}	<p>Use in MT 103: The participant may request SWIFT validation according to the rules of the MT 103+ by using {119:STP}. If this field is not available, MT 103 core will follow.</p> <p>Use in MT 202 COV: The placement of field 119 with code COV is mandatory. {119:REMIT} is not allowed in SSP.</p>
115	Addressee Information	{115: HHMMSS HHMMSS 2!a 16x}	<p>This field is present when the receiver receives this message via Y-copy Service.</p> <p>This is synonymous with settling the payment in the PM.</p> <p>It contains information from the PM:</p>

9 Technical Specifications

- 9.1 SWIFTNet FIN related issues
- 9.1.2 SWIFTNet FIN Messages - Details

User Header			
Tag	Field name	Content/Options	Use in SSP
			<ul style="list-style-type: none">• Time of crediting RTGS account of receiver• Time of debiting RTGS account of sender• Country code of sender• SSP internal posting reference for unique identification <p>Credit and debit time are same for payments inside PM and between PM and HAM or proprietary home accounting system.</p>

Note: Field 121 must follow SWIFT specifications: xxxxxxxx-xxxx-4xxx-yxxx-xxxxxxxxxxxx where x is any hexadecimal character (lower case only) and y is one of 8, 9, a or b.

9.1.2.1.2 Trailer

9.1.2.1.2.1 General description

The trailer of a message differs according to the following cases:

- the participant sends a message to the SWIFT network,
- the participant receives a message from the SWIFT network via Y-copy or
- the participant receives a message from the SWIFT network, but not via Y-copy

All fields in the trailers are put in braces ({}).

Note: The individual fields (tags) of the trailers are described in detail in the SWIFT User Handbook “FIN System Messages”.

General information

9 Technical Specifications

- 9.1 SWIFTNet FIN related issues
- 9.1.2 SWIFTNet FIN Messages - Details

Structure when sending a message

The following table describes the trailers when the participant sends the message to the SWIFT network. (It is an outgoing payment from the participant's point of view.)

Trailer				
Status	Tag	Field name	Content/Options	Use in SSP
-	-	Block Identifier	5:	-
M	MAC	Authentication Code	{MAC:8!h}	-
M	PAC	Proprietary Authentication Code	{PAC:8!h}	-
M	CHK	Checksum	{CHK:12!h}	-
O	TNG	Training	{TNG:}	Only in test and training mode.
O	PDE	Possible Duplicate Emission	{PDE:[<time><mir>]}	-

Structure when receiving a message via Y-copy

The following table describes the trailers when the participant receives a payment message from the SWIFT network. (It is an incoming payment via Y-copy from the participant's point of view, User Header contains {103:TGT}.)

Trailer				
Status	Tag	Field name	Content/Options	Use in SSP
M	-	Block Identifier	5:	-

9 Technical Specifications

- 9.1 SWIFTNet FIN related issues
- 9.1.2 SWIFTNet FIN Messages - Details

Trailer				
Status	Tag	Field name	Content/Options	Use in SSP
		fier		
M	MAC	Authentication Code	{MAC:8!h}	-
M	PAC	Proprietary Authentication Code	{PAC:8!h}	-
M	CHK	Checksum	{CHK:12!h}	-
O	TNG	Training	{TNG:}	Only in test and training mode.
O	PDE	Possible Duplicate Emission	{PDE:[<time><mir>]}	-
O	PDM	Possible Duplicate Message	{PDM:[<time>><mor>]}	-
O	DLM	Delayed Message	{DLM:}	-

Structure when receiving a message via normal FIN (no Y-copy)

The following table describes the trailers when the participant receives a message via the SWIFT network from the SSP. (It is an incoming message from the participant's point of view, no Y-copy.)

Trailer				
Status	Tag	Field name	Content/Options	Use in SSP
M	-	Block Identifier	5:	-

9 Technical Specifications

- 9.1 SWIFTNet FIN related issues
- 9.1.2 SWIFTNet FIN Messages - Details

Trailer				
Status	Tag	Field name	Content/Options	Use in SSP
O	MAC	Authentication Code	{MAC:8!h}	-
M	CHK	Checksum	{CHK:12!h}	-
O	TNG	Training	{TNG:}	Only in test and training mode
O	PDE	Possible Duplicate Emission	{PDE:[<time><mir>]}	-
O	PDM	Possible Duplicate Message	{PDM:[<time>><mor>]}	-
O	DLM	Delayed Message	{DLM:}	-

9.1.2.1.2.2 Handling of PDM/PDE Trailer

PDM trailer is set by SWIFT. It is used to warn the receiver that the same message may already have been delivered by SWIFT. The reason for sending a message with PDM trailer is, that SWIFT does not know whether the payment message was already sent.

If PM receives a message it checks in addition to the double entry check whether the payment message is delivered twice (without PDM trailer and with PDM trailer):

- If the payment message without PDM trailer was already delivered then the message with the PDM trailer will be discovered by PM. It will get a final status (“closed - duplicate input”) without any further processing. The message with PDM trailer will not be delivered to the receiver.

PDM Trailer (Possible Duplicate Message Trailer)

9.1	SWIFTNet FIN related issues
9.1.2	SWIFTNet FIN Messages - Details

PDE Trailer (Possible Duplicate Emission Trailer)

- If the payment message without PDM trailer was not yet delivered then the message with the PDM trailer will be processed and delivered to the receiver after settled successfully.
- If the message without PDM trailer is delivered after the message with the PDM trailer it will be discovered by PM and will get a final status ("closed - duplicate input") without any further processing. It will not be delivered to the receiver.

PDE trailer is set by the sender of the message. It is used to warn the receiver that the same message may already have been received. The reason for sending a message with PDE trailer is that the sender is not sure, whether the payment message was already sent.

If PM receives a message it checks in addition to the double entry check whether the message is delivered twice (without PDE trailer and with PDE trailer):

- If the original payment message (without PDE trailer) was already delivered, the message with PDE trailer will be discovered by PM. It will be rejected. PM will send a negative MT 97 to SWIFT and consequently the sender will receive an MT 019 with a unique error code.

9 Technical Specifications

- 9.1 SWIFTNet FIN related issues
- 9.1.2 SWIFTNet FIN Messages - Details

Example:

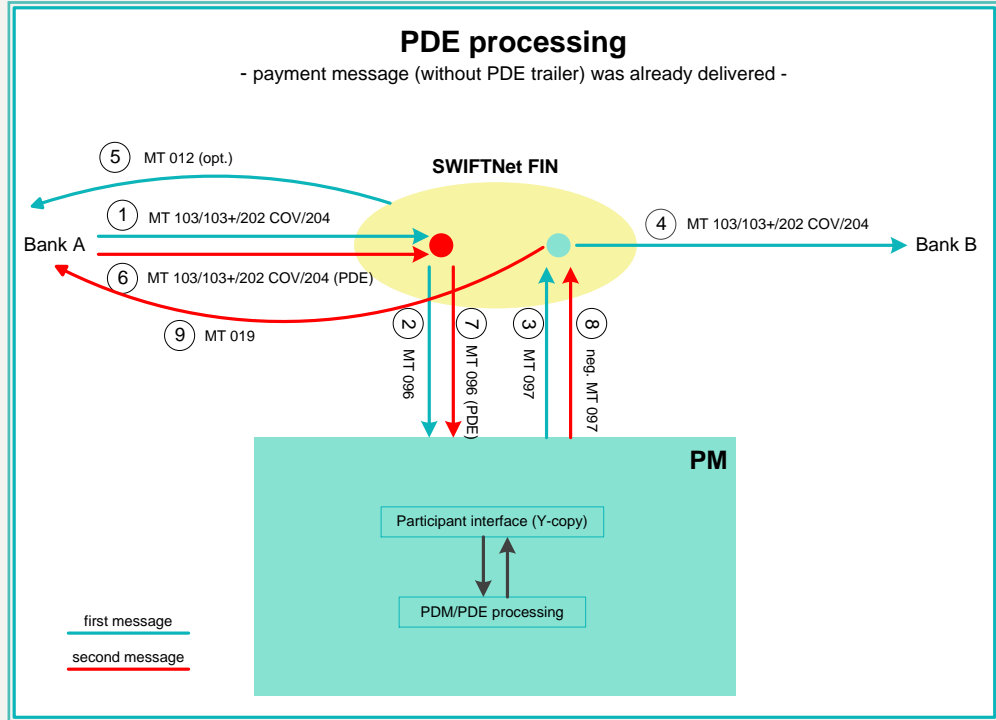

Step	Description
1	Bank A sends a payment message to PM
2	SWIFT delivers the settlement request (MT 096) to PM
3	PM checks whether the same payment message with PDE trailer already arrived. Because it is not the case PM settles the payment, creates a positive settlement confirmation (M 097) and sends it to SWIFT
4	SWIFT delivers the payment message to Bank B
5	If Bank A requested to receive a sender notification (MT 012) it will be delivered by SWIFT

9 Technical Specifications

- 9.1 SWIFTNet FIN related issues
- 9.1.2 SWIFTNet FIN Messages - Details

Step	Description
6	Bank A sends the same payment message with PDE trailer
7	SWIFT delivers the MT 096 with PDE trailer to PM
8	PM recognises that the message was already received without PDE trailer and creates a negative MT 097 with a unique error code
9	Consequently SWIFT sends an MT 019 containing the error code to Bank A.

- If the payment message without PDE trailer was not yet delivered, the message with the PDE trailer will be processed in PM and delivered to the receiver after settled successfully.

Example:

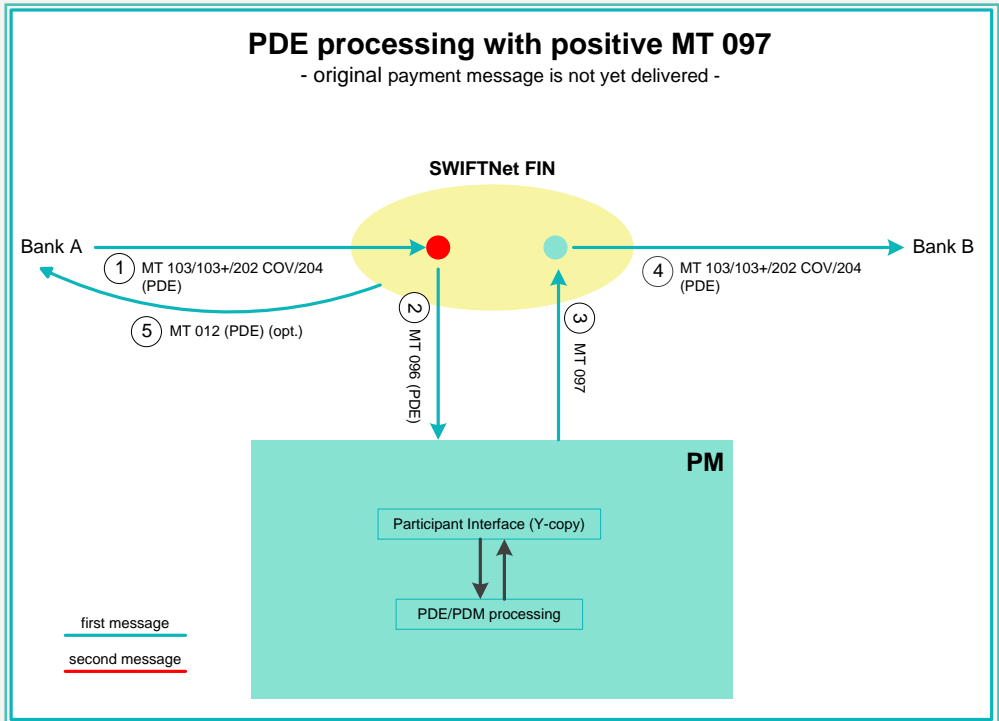

9 Technical Specifications

- 9.1 SWIFTNet FIN related issues
- 9.1.2 SWIFTNet FIN Messages - Details

Step	Description
1	Bank A sends a payment message with a PDE trailer to PM
2	SWIFT delivers the settlement request (MT 096) with PDE trailer to PM
3	PM checks whether the payment message without PDE trailer already arrived. Because it is not the case PM settles the payment, creates a positive settlement confirmation (MT 097) with PDE trailer and sends it to SWIFT
4	SWIFT delivers the payment message with the PDE trailer to Bank B, which has to check in the result if he has already received the original message (see SWIFT User Handbook FIN Service Description, Chapter 5 Message Structures 5.10.5)
5	If requested SWIFT sends a sender notification (MT 012) to Bank A

- If the payment message (without PDE trailer) is delivered after the message with the PDE trailer then the message without the PDE trailer will be discovered by PM. It will create a negative settlement confirmation (MT 097).

Example:

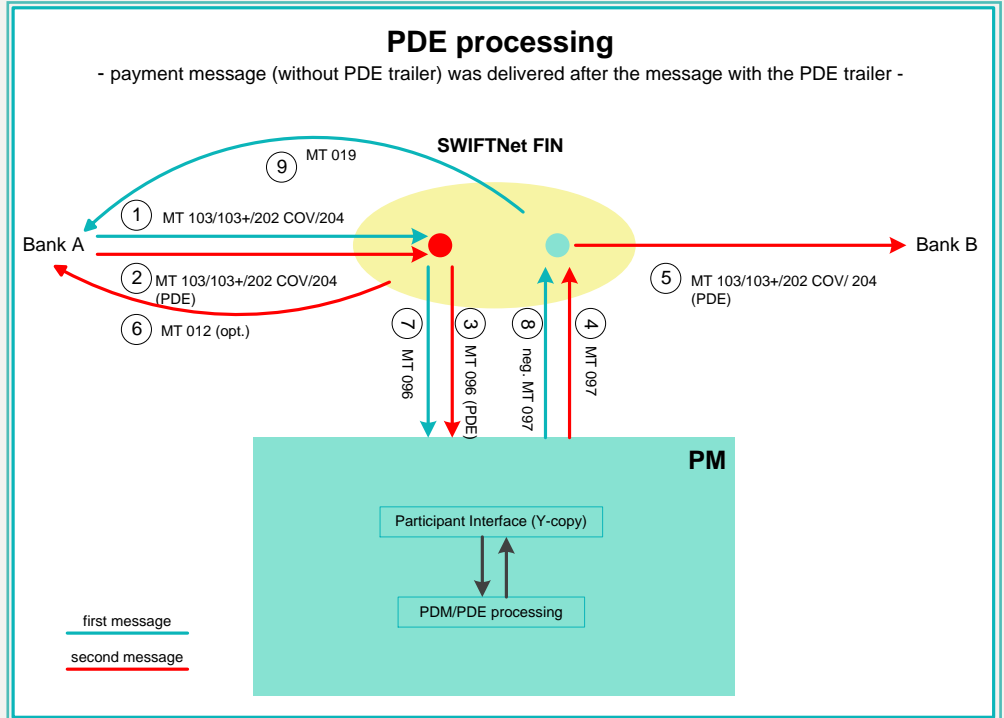

Step	Description
1	Bank A sends a payment message to PM
2	After a while Bank A sends the same payment message with PDE trailer
3	SWIFT delivers the settlement request (MT 096) with PDE trailer to PM
4	PM checks whether the same payment message without PDE trailer already arrived. Because it is not the case, PM settles the payment with PDE trailer and creates a positive settlement confirmation (MT 097) with PDE trailer
5	SWIFT delivers the payment message with the PDE trailer to Bank B, which has to check whether it has already received the payment message without PDE trailer

9 Technical Specifications

- 9.1 SWIFTNet FIN related issues
- 9.1.2 SWIFTNet FIN Messages - Details

Step	Description
	(see SWIFT User Handbook FIN Service Description, Chapter 5 Message Structures 5.10.5)
6	If requested SWIFT sends a sender notification (MT 012) to Bank A
7	In the meantime SWIFT creates an MT 096, which is based on the payment message without PDE trailer (see step 1)
8	PM checks whether the same payment message without PDE trailer already arrived. Because it is the case, PM creates a negative settlement confirmation (MT 097) with a unique error code
9	SWIFT sends an Abort Notification (MT 019) with a unique error code to Bank A

9.1.2.2 Textblock of the different message types

9.1.2.2.1 Payment messages

9.1.2.2.1.1 MT 103

Usage

This message type is used to execute a payment order if the ordering party or the beneficiary, or both, are non-financial institutions.

In the following table the standard validation profile for MT 103 is described. The STP validation profile (MT 103+) is separately described (see chapter [9.1.2.2.1.2 MT 103+, page 442](#)).

Structure

The following table describes the structure of MT 103 (standard format) used in SSP:

SWIFT standard			SSP Specifications		
Status	Field	Field name	Status	Format	Use in SSP
M	20	Sender's Reference	M	16x	

9 Technical Specifications

- 9.1 SWIFTNet FIN related issues
- 9.1.2 SWIFTNet FIN Messages - Details

SWIFT standard			SSP Specifications		
Status	Field	Field name	Status	Format	Use in SSP
---->					
O	13C	Time Indication	O	/8c/4!n1!x4!n	<p>PM: The following codes in addition to the SWIFT standard can be used to set an execution time:</p> <ul style="list-style-type: none"> • /TILTIME/hhmm+/-iinn • /FROTIME/hhmm+/-iinn • /REJTIME/hhmm+/-iinn <p>hhmm must be before the cut-off time for customer payments (17.00 under normal circumstances)</p> <p>Note: This field has to be filled in according to the SWIFT standard. li and nn are the hours and minutes of UTC shift whereas the „hhmm“ are to be filled with the local time of the user. This is valid for the code-words TILTIME, REJTIME and FROTIME.</p> <p>If TILTIME and REJTIME are both mentioned only the first one is used by SSP.</p> <p>However, the codeword /CLSTIME/ has to be used in field 72 and not according to the SWIFT standard in field 13C.</p>

M	23B	Bank Operation Code	M	4!c	
---->					

9 Technical Specifications

- 9.1 SWIFTNet FIN related issues
- 9.1.2 SWIFTNet FIN Messages - Details

SWIFT standard			SSP Specifications		
Status	Field	Field name	Status	Format	Use in SSP
O	23E	Instruction Code	O	4!c[/30x]	

O			O	3!c	
M	32A	Value Date/ Currency/ Interbank Settled Amount	M	6!n3!a15d	Payments can be sent for the current business day and up to five TARGET working days in advance. Payments must be denominated in euro only. Exception: Value date check is switched off for the sender's RTGS account by the responsible CB or SSP-OT.
O	33B	Currency/ Instructed Amount	O	3!a15d	Network Validated Rules in SWIFT User Handbook
O	36	Exchange Rate	O	12d	If the currency code is different from the currency code in field 32A, field 36 must be present, otherwise field 36 is not allowed.
M	50a	Ordering Customer	M	Option A: [/34x]4!a2!a2 !c[3!c] Option F: 35x 4*35x Option K: [/34x] 4*35x	

9 Technical Specifications

- 9.1 SWIFTNet FIN related issues
- 9.1.2 SWIFTNet FIN Messages - Details

SWIFT standard			SSP Specifications		
Status	Field	Field name	Status	Format	Use in SSP
O	51A	Sending Institution	-	-	Must not be used
O	52a	Ordering Institution	O	Option A: [/1!a]/[34x] 4!a2!a2!c [3!c] Option D: [/1!a]/[34x] 4*35x	
O	53a	Sender's Correspondent	O	Option A: [/1!a]/[34x] 4!a2!a2!c [3!c] Option B: [/1!a]/[34x] [35x] Option D: [/1!a]/[34x] 4*35x	
O	54a	Receiver's Correspondent	O	Option A: [/1!a]/[34x] 4!a2!a2!c [3!c] Option B: [/1!a]/[34x] [35x] Option D: [/1!a]/[34x] 4*35x	

9 Technical Specifications

- 9.1 SWIFTNet FIN related issues
- 9.1.2 SWIFTNet FIN Messages - Details

SWIFT standard			SSP Specifications		
Status	Field	Field name	Status	Format	Use in SSP
O	55a	Third Reimbursement Institution	O	Option A: [/1!a]/[34x] 4!a2!a2!c [3!c] Option B: [/1!a] [/34x] [35x] Option D: [/1!a]/[34x] 4*35x	
O	56a	Intermediary Institution	O	Option A: [/1!a]/[34x] 4!a2!a2!c [3!c]	Only option A is allowed. Other options are rejected.
O	57a	Account With Institution	O/M	Option A: [/1!a]/[34x] 4!a2!a2!c [3!c] Option D: [/1!a]/[34x] 4*35x	Only option A or D is allowed. Other options are rejected. PM: Field 57a is mandatory in case receiver is a CB customer liquidity bridge.
M	59a	Beneficiary-Customer	M	Option A: [/34x] 4!a2!a2!c [3!c] Option F: [/34x] 4*(1!n/33x) no letter	

9 Technical Specifications

- 9.1 SWIFTNet FIN related issues
- 9.1.2 SWIFTNet FIN Messages - Details

SWIFT standard			SSP Specifications		
Status	Field	Field name	Status	Format	Use in SSP
				option: [/34x] 4*35x	
O	70	Remittance Information	O	4*35x	
M	71A	Details of Charges	M	OUR / SHA / BEN	
---->					
O	71F	Sender's Charges	O	3!a15d	

O	71G	Receiver's Charges	O	3!a15d	
O	72	Sender to Receiver Information	O	6*35x	
O	77B	Regulatory Reporting	O	3*35x	
O	77T	Envelope Contents	-	9000z	Must not be used

9.1.2.2.1.2 MT 103+

Usage

This message type is used to execute a payment order if the ordering party or the beneficiary, or both, are non-financial institutions.

9 Technical Specifications

- 9.1 SWIFTNet FIN related issues
- 9.1.2 SWIFTNet FIN Messages - Details

In the following table the STP validation profile of MT 103+ is described. The standard validation profile (MT 103) is described separately (see chapter 9.1.2.2.1.1 MT 103, page 437).

Structure

The following table describes the structure of MT 103+ (STP format) used in SSP:

SWIFT standard			SSP Specifications		
Status	Field	Field name	Status	Format	Use in SSP
M	20	Sender's Reference	M	16x	
----->					
O	13C	Time Indication	o	/8c/4!n1!x4!n	<p>PM: The following codes in addition to the SWIFT standard can be used to set an execution time:</p> <ul style="list-style-type: none"> • /TILTIME/hhmm+/-iinn • /FROTIME/hhmm+/-iinn • /REJTIME/hhmm+/-iinn <p>hhmm must be before the cut-off time for customer payments (17.00 under normal circumstances)</p> <p>Note: This field has to be filled in according to the SWIFT standard. li and nn are the hours and minutes of UTC shift whereas the „hhmm“ are to be filled with the local time of the user. This is valid for the code-words TILTIME, REJTIME and FROTIME.</p> <p>If TILTIME and REJTIME are both mentioned only the first one is used by SSP.</p>

9 Technical Specifications

- 9.1 SWIFTNet FIN related issues
- 9.1.2 SWIFTNet FIN Messages - Details

SWIFT standard			SSP Specifications		
Status	Field	Field name	Status	Format	Use in SSP
					However, the codeword /CLSTIME/ has to be used in field 72 and not according to the SWIFT standard in field 13C.

M	23B	Bank Operation Code	M	4!c	
---->					
O	23E	InstructionCode	O	4!c[/30x]	Only the codewords <ul style="list-style-type: none"> • CORT • INTC • SDVA • REPA are allowed.

O	26T	Transaction Type Code	O	3!c	
M	32A	Value Date/ Currency/ Interbank Settled Amount	M	6!n3!a15d	Payments can be sent for the current business day and up to five TARGET working days in advance. Payments must be denominated in euro only. Exception: Value date check is switched off for the sender's RTGS account by the responsible CB or SSP-OT.
O	33B	Currency/ Instructed	O	3!a15d	Network Validated Rules in SWIFT User Handbook

9 Technical Specifications

- 9.1 SWIFTNet FIN related issues
- 9.1.2 SWIFTNet FIN Messages - Details

SWIFT standard			SSP Specifications		
Status	Field	Field name	Status	Format	Use in SSP
		Amount			
O	36	Exchange Rate	O	12d	If the currency code is different from the currency code in field 32A, field 36 must be present, otherwise field 36 is not allowed.
M	50a	Ordering Customer	M	Option A: [/34x]4!a2!a2!c[3!c] Option F: 35x 4*35x Option K: [/34x]4*35x	
O	52A	Ordering Institution	O	Option A: [/1!a]/[34x]4!a2!a2!c[3!c]	
O	53a	Sender's Correspondent	O	Option A: [/1!a]/[34x]4!a2!a2!c[3!c] Option B: [/1!a] [/34x] [35x]	
O	54A	Receiver's Correspondent	O	Option A: [/1!a]/[34x]4!a2!a2!c[3!c]	
O	55A	Third Reim-	O	Option A:	

9 Technical Specifications

- 9.1 SWIFTNet FIN related issues
- 9.1.2 SWIFTNet FIN Messages - Details

SWIFT standard			SSP Specifications		
Status	Field	Field name	Status	Format	Use in SSP
		bursement Institution		[/1!a]/[34x] 4!a2!a2!c [3!c]	
O	56A	Intermediary Institution	O	Option A: [/1!a]/[34x] 4!a2!a2!c [3!c]	
O	57A	Account With Institution	O/M	Option A: [/1!a]/[34x] 4!a2!a2!c [3!c]	PM: Field 57a is mandatory in case receiver is a CB customer liquidity bridge.
M	59a	Beneficiary Customer	M	Option A: [/34x] 4!a2!a2!c [3!c] Option F: [/34x] 4*(1!n/33x) no letter option: [/34x] 4*35x	An account line must be stated.
O	70	Remittance Information	O	4*35x	
M	71A	Details of Charges	M	OUR / SHA / BEN	
----->					
O	71F	Sender's	O	3!a15d	

9 Technical Specifications

- 9.1 SWIFTNet FIN related issues
- 9.1.2 SWIFTNet FIN Messages - Details

SWIFT standard			SSP Specifications		
Status	Field	Field name	Status	Format	Use in SSP
		Charges			

O	71G	Receiver's Charges	O	3!a15d	
O	72	Sender to Receiver Information	O	6*35x	Code words REJT and RETN or ERI details are not allowed.
O	77B	Regulatory Reporting	O	3*35x	

9.1.2.2.1.3 MT 202

Usage This message type is used to transfer credit balances between financial institutions.

Structure The following table describes the structure of the MT 202:

Note: The incoming messages linked to AS settlement must be sent with the priority “highly urgent” and with the current business day, same is true for liquidity transfers with T2S.

Information on the “MT 202 simplified” used in relation to the HAM is provided in **chapter 14.1.2.2.1.5 MT 202 simplified (HAM only) in book 2 of the UDFS.**

SWIFT standard			SSP Specifications		
Status	Field	Field name	Status	Format	Use in SSP
M	20	Transaction Reference Number	M	16x	

9 Technical Specifications

- 9.1 SWIFTNet FIN related issues
- 9.1.2 SWIFTNet FIN Messages - Details

SWIFT standard			SSP Specifications		
Status	Field	Field name	Status	Format	Use in SSP
M	21	Related Reference	M	16x	<p>PM: For outgoing messages linked to AS settlement: Copy of EndToEndIdentification contained in PaymentTransaction</p> <p>For liquidity transfers with T2S: Copy to or from EndToEndIdentification of the XML message exchanged with T2S</p>
---->					
O	13C	Time Indication	O	/8c/4!n1!x4!n	<p>PM: The following codes in addition to the SWIFT standard can be used to set an execution time:</p> <ul style="list-style-type: none"> • /TILTIME/hhmm+/-iinn • /FROTIME/hhmm+/-iinn • /REJTIME/hhmm+/-iinn <p>hhmm must be before the cut-off time for bank-to-bank payments (18.00 under normal circumstances) and in case of messages addressed to TRGTXPMT2S also before the cut-off time for liquidity transfers to T2S (17.45 under normal circumstances).</p> <p>Note:</p> <ul style="list-style-type: none"> • For incoming messages linked to the liquidity credit transfer to technical account – procedure 6 – real-time in AS settlement: the authorised codes are

9 Technical Specifications

- 9.1 SWIFTNet FIN related issues
- 9.1.2 SWIFTNet FIN Messages - Details

SWIFT standard			SSP Specifications		
Status	Field	Field name	Status	Format	Use in SSP
					<ul style="list-style-type: none"> – /FROTIME/hhmm+/-iinn – /REJTIME/hhmm+/-iinn <p>• For outgoing messages linked to AS settlement: not relevant</p> <p>Note: This field has to be filled in according to the SWIFT standard. ii and nn are the hours and minutes of UTC shift whereas the „hhmm“ are to be filled with the local time of the user. This is valid for the code-words TILTIME, REJTIME and FROTIME.</p> <p>If TILTIME and REJTIME are both mentioned only the first one is used by SSP.</p> <p>However, the codeword /CLSTIME/ has to be used in field 72 and not according to the SWIFT standard in field 13C.</p> <p>For incoming messages addressed to TRGTXPMT2S:</p> <ul style="list-style-type: none"> • F13C settlement times are only accepted during day trade phase • F13C settlement times cannot be processed in case of Pull Liquidity from T2S

M	32A	Value Date, Currency Code,	M	6!n3!a15d	Payments can be sent for the current business day and up to five TARGET working days in advance.

9 Technical Specifications

- 9.1 SWIFTNet FIN related issues
- 9.1.2 SWIFTNet FIN Messages - Details

SWIFT standard			SSP Specifications		
Status	Field	Field name	Status	Format	Use in SSP
		Amount			<p>Payments must be denominated in euro only.</p> <p>PM:</p> <p>Exceptions:</p> <ul style="list-style-type: none"> • Value date check is switched off for the sender's RTGS account by the responsible CB or SSPOT. • Messages with future value date may not be addressed to TRGTXEPM2S. Warehoused liquidity transfers to T2S are not supported. (Standing orders may be used/adjusted instead.) <p>ASI:</p> <p>Exceptions:</p> <ul style="list-style-type: none"> • Messages with future value date may not be addressed to TRGTXEPMASI. Warehoused liquidity transfers to ASI are not supported. <p>HAM:</p> <p>Exceptions:</p> <ul style="list-style-type: none"> • Messages with future value date may not be addressed to TRGTXEPMHAM. Warehoused liquidity transfers to HAM are not supported.
O	52a	Ordering Institution	O	<p>Option A: [!a]/34x 4!a2!a2!c [3!c]</p> <p>Option D: [!a]/34x]</p>	<p>PM:</p> <ul style="list-style-type: none"> • For incoming messages linked to AS settlement: may be used to pass on information on the debtor • For outgoing messages

9 Technical Specifications

- 9.1 SWIFTNet FIN related issues
- 9.1.2 SWIFTNet FIN Messages - Details

SWIFT standard			SSP Specifications		
Status	Field	Field name	Status	Format	Use in SSP
				4*35x	<p>linked to AS settlement:</p> <ul style="list-style-type: none"> – If a valid BIC is indicated as debtor in the ASTransferInitiation <p>Option A: Copy of the account (adjusted to format/34x) from the DebtorAccount (if filled) and Copy of the BIC indicated as debtor</p> – If no BIC is indicated as debtor the field 52A will be empty <ul style="list-style-type: none"> • For outgoing messages (payments from HAM): it contains the BIC of the debtor • For incoming messages addressed to TRGTXEPM2S to initiate liquidity transfers with T2S: <ul style="list-style-type: none"> – If used option A is mandatory and a valid BIC of an RTGS account holder has to be indicated and optionally the related RTGS account ID • For outgoing messages due to liquidity transfers from T2S: <ul style="list-style-type: none"> – Option A is used by default. Filled with Dedicated Cash Account ID received from T2S and related account

9 Technical Specifications

- 9.1 SWIFTNet FIN related issues
- 9.1.2 SWIFTNet FIN Messages - Details

SWIFT standard			SSP Specifications		
Status	Field	Field name	Status	Format	Use in SSP
					<p>owner BIC</p> <ul style="list-style-type: none"> – Option D will be used if the DCA ID received from T2S is unknown in TARGET2. The account ID and constant "unknown DCA owner" will be mentioned
O	53a	Sender's Correspondent	O	<p>Option A: [!a]/34x 4!a2!a2!c [3!c]</p> <p>Option B: [!a]/34x [35x]</p> <p>Option D: [!a]/34x 4*35x</p>	<p>PM:</p> <ul style="list-style-type: none"> • Must not be filled in messages linked to ancillary system settlement. • For outgoing messages (payments from HAM) it contains the BIC of the debtor's CB. • For incoming messages addressed to TRGTXPMT2S used to pull liquidity from the indicated DCA in T2S: Option A with the BIC of the DCA holder and the DCA ID to be debited is mandatory.
O	54a	Receiver's Correspondent	O	<p>Option A: [!a]/34x 4!a2!a2!c [3!c]</p> <p>Option B: [!a]/34x [35x]</p> <p>Option D: [!a]/34x 4*35x</p>	<p>PM:</p> <ul style="list-style-type: none"> • Must not be filled in messages linked to ancillary system settlement. • Must not be used in messages addressed to TRGTXPMT2S.
O	56a	Intermediary	O	Option A:	Only option A is allowed. Other

9 Technical Specifications

- 9.1 SWIFTNet FIN related issues
- 9.1.2 SWIFTNet FIN Messages - Details

SWIFT standard			SSP Specifications		
Status	Field	Field name	Status	Format	Use in SSP
				[/1!a]/[34x] 4!a2!a2!c [3!c]	options are rejected. PM: <ul style="list-style-type: none"> • Must not be filled in messages linked to ancillary system settlement • Must not be used in messages addressed to TRGTXPMT2S.

9 Technical Specifications

- 9.1 SWIFTNet FIN related issues
- 9.1.2 SWIFTNet FIN Messages - Details

SWIFT standard			SSP Specifications		
Status	Field	Field name	Status	Format	Use in SSP
O	57a	Account With Institution	O/M	Option A: [!a]/34x 4!a2!a2!c [3!c]	<p>Only option A is allowed. Other options are rejected.</p> <p>PM:</p> <ul style="list-style-type: none"> • For incoming messages linked to AS settlement: mandatory for the real-time model; it must be the BIC of a technical account – procedure 6 – real-time linked to the sender (settlement bank) not filled for the interfaced model • For outgoing messages linked to AS settlement: not filled • Must not be used in messages addressed to TRGTXEPM2S. • Field 57a is mandatory in case receiver is a CB customer liquidity bridge.
M	58a	Beneficiary Institution	M	<p>Option A: [!a]/34x 4!a2!a2!c [3!c]</p> <p>Option D: [!a]/34x 4*35x</p>	<p>PM:</p> <ul style="list-style-type: none"> • For incoming messages linked to AS settlement: may be used to pass on information on the creditor in the AS. For the interfaced AS Option A only is allowed (BIC of the RTGS account of the sender and sub-account of this RTGS account) • For outgoing messages linked to AS settlement: <ul style="list-style-type: none"> – If a valid BIC is indicated as creditor in the AS Transfer Initiation Option A:

9 Technical Specifications

- 9.1 SWIFTNet FIN related issues
- 9.1.2 SWIFTNet FIN Messages - Details

SWIFT standard			SSP Specifications		
Status	Field	Field name	Status	Format	Use in SSP
					<p>Copy of the account (adjusted to format/34x) from the CreditorAccount (if filled) and copy of the BIC indicated as creditor</p> <ul style="list-style-type: none"> – If no BIC is indicated as creditor, the field 58A will be filled only with the BIC of the FinalAgent <ul style="list-style-type: none"> • For incoming messages addressed to TRGTXEPMT2S: <ul style="list-style-type: none"> Option A is mandatory – BIC of the DCA holder and the DCA ID to be credited (push liquidity), – Or BIC of the RTGS account to be credited (pull liquidity). • For outgoing messages due to liquidity transfers from T2S: BIC of the RTGS account credited due to incoming liquidity transfer from T2S.
O	72	Sender to Receiver Information	O	6*35x	<p>PM: /BUP/ = codeword to indicate backup payments. /CLSTIME/hhmm If hhmm is present it must be before the cut-off time for bank-to-bank payments (18.00 under normal circumstances). Automatic notification is triggered via ICM 15 minutes prior the defined time. But note that code-</p>

9 Technical Specifications

- 9.1 SWIFTNet FIN related issues
- 9.1.2 SWIFTNet FIN Messages - Details

SWIFT standard			SSP Specifications		
Status	Field	Field name	Status	Format	Use in SSP
					<p>word CLSTIME is ignored by SSP, if codeword TILTIME or REJTIME is used in field 13C.</p> <p>/MANPAY/ = codeword to indicate a mandated payment</p> <p>Note: For ASI, the codeword /ASINF/ must be added before /MANPAY/.</p> <p>/INS/ followed by BIC of the technical account – procedure 6 – real-time from FirstAgent field = code-word used in outgoing payments linked to AS settlement</p> <p>/ASDB/ (Debtor Name or, if neither Debtor BIC nor Debtor Name present in the ASTransferInitiation message, Debtor Domestic Account)</p> <p>/ASCR/ (Creditor Name or, if neither Creditor BIC nor Creditor Name present in the ASTransferInitiation message, Creditor Domestic account)</p> <p>[The Debtor Name (70x) and Creditor Name (70x) are truncated to 62 characters]</p> <p>/ASINF/ + optional free text = codeword used in incoming and outgoing payments linked to AS settlement</p> <p>/ESCBSTAT/ followed by "2I" for setting up or reimbursement of repo operations with the central bank for intraday credit.</p>

9 Technical Specifications

- 9.1 SWIFTNet FIN related issues
- 9.1.2 SWIFTNet FIN Messages - Details

SWIFT standard			SSP Specifications		
Status	Field	Field name	Status	Format	Use in SSP
					For incoming messages addressed to TRGTXPMT2S: The only codeword that may be used is /MANPAY/. Other codes must not be used.

Note: Unless otherwise stated, fields related to incoming messages linked to AS settlement are mapped to the ASTransferNotice message sent by ASI to the AS and fields related to outgoing messages linked to AS settlement are mapped from the ASTransferInitiation sent by the AS to the ASI.

9.1.2.2.1.4 MT 202 COV

Usage This message type is used to transfer credit balances between financial institutions.

It must only be used to order the movement of funds related to an underlying customer credit transfer that was sent with the cover method.

The MT 202 COV must not be used for any other interbank transfer or liquidity transfer addressed to any PM BIC (eg TRGTXPMT2S). For these transfers the MT 202 must be used.

Structure The MT 202 consists of two sequences

- Sequence A - General Information which contains information on the financial institution transfer between the ordering institution and beneficiary institution and
- Sequence B - Underlying Customer Credit Transfer is used to provide details on an individual underlying customer credit transfer that was sent with the cover method.

9 Technical Specifications

- 9.1 SWIFTNet FIN related issues
- 9.1.2 SWIFTNet FIN Messages - Details

Note: Sequence B is not displayed in ICM.

The following table describes the structure of the MT 202 COV:

SWIFT standard			SSP Specifications		
Status	Field	Field name	Status	Format	Use in SSP
Sequence A General Information					
M	20	Transaction-Reference Number	M	16x	
M	21	Related Reference	M	16x	
---->					
O	13C	Time Indication	O	/8c/4!n1!x4!n	<p>PM: The following codes in addition to the SWIFT standard can be used to set an execution time:</p> <ul style="list-style-type: none"> • /TILTIME/hhmm+/-iinn • /FROTIME/hhmm+/-iinn • /REJTIME/hhmm+/-iinn <p>hhmm must be before the cut-off time for bank-to-bank payments (18.00 under normal circumstances)</p> <p>Note: This field has to be filled in according to the SWIFT standard.</p> <p>ii and nn are the hours and minutes of UTC shift whereas the “hhmm“ are to be filled with the local time of the user. This is valid for the code-words TILTIME, REJTIME and FROTIME.</p> <p>If TILTIME and REJTIME are both</p>

9 Technical Specifications

- 9.1 SWIFTNet FIN related issues
- 9.1.2 SWIFTNet FIN Messages - Details

SWIFT standard			SSP Specifications		
Status	Field	Field name	Status	Format	Use in SSP
					mentioned only the first one is used by SSP. However, the codeword /CLSTIME/ has to be used in field 72 and not according to the SWIFT standard in field 13C.
M	32A	Value Date, Currency Code, Amount	M	6!n3!a15d	Payments can be sent for the current business day and up to five TARGET working days in advance. Payments must be denominated in euro only. PM: Exception: Value date check is switched off for the sender's RTGS account by the responsible CB or SSP-OT. HAM: Exception: Messages with future value date may not be addressed to TRGTXEPMHAM. Warehoused liquidity transfers to HAM are not supported.
O	52a	Ordering Institution	O	Option A: [!a]/[34x] 4!a2!a2!c [3!c] Option D: [!a]/[34x] 4*35x	
O	53a	Sender's Correspond-	O	Option A: [!a]/[34x]	

9 Technical Specifications

- 9.1 SWIFTNet FIN related issues
- 9.1.2 SWIFTNet FIN Messages - Details

SWIFT standard			SSP Specifications		
Status	Field	Field name	Status	Format	Use in SSP
		ent		4!a2!a2!c [3!c] Option B: [!1!a]/[34x] [35x] Option D: [!1!a]/[34x] 4*35x	
O	54a	Receiver's Correspondent	O	Option A: [!1!a]/[34x] 4!a2!a2!c [3!c] Option B: [!1!a]/[34x] [35x] Option D: [!1!a]/[34x] 4*35x	
O	56a	Intermediary	O	Option A: [!1!a]/[34x] 4!a2!a2!c [3!c]	Only option A is allowed. Other options are rejected.
O	57a	Account With Institution	O/M	Option A: [!1!a]/[34x] 4!a2!a2!c [3!c]	Only option A is allowed. Other options are rejected. PM: Field 57a is mandatory in case receiver is a CB customer liquidity bridge.
M	58a	Beneficiary Institution	M	Option A: [!1!a]/[34x]	

9 Technical Specifications

- 9.1 SWIFTNet FIN related issues
- 9.1.2 SWIFTNet FIN Messages - Details

SWIFT standard			SSP Specifications		
Status	Field	Field name	Status	Format	Use in SSP
				4!a2!a2!c [3!c] Option D: [/1!a]/[34x] 4*35x	
O	72	Sender to Receiver Information	O	6*35	PM: /BUP/ = codeword to indicate backup payments. /CLSTIME/hhmm If hhmm is present it must be before the cut-off time for bank-to-bank payments (18.00 under normal circumstances). Automatic notification is triggered via ICM 15 minutes prior the defined time. But note that codeword CLSTIME is ignored by SSP, if codeword TILTIME or REJTIME is used in field 13C. /MANPAY/ = codeword to indicate a mandated payment.
Sequence B underlying customer credit transfer details					
M	50a	Ordering Customer	M	Option A: [/34x]4!a2!a2!c[3!c] Option F: 35x 4*35x Option K: [/34x] 4*35x	
O	52a	Ordering	O	Option A:	

9 Technical Specifications

- 9.1 SWIFTNet FIN related issues
- 9.1.2 SWIFTNet FIN Messages - Details

SWIFT standard			SSP Specifications		
Status	Field	Field name	Status	Format	Use in SSP
		Institution		[/1!a]/[34x] 4!a2!a2!c [3!c] Option D: [/1!a]/[34x] 4*35x	
O	56a	Intermediary Institution	O	Option A: [/1!a]/[34x] 4!a2!a2!c [3!c] Option C: /34x Option D: [/1!a]/[34x] 4*35x	
O	57a	Account With Institution	O	Option A: [/1!a]/[34x] 4!a2!a2!c [3!c] Option B: [/1!a]/[34x] [35x] Option C: /34x Option D: [/1!a]/[34x] 4*35x	
M	59a	Beneficiary-Customer	M	Option A: [/34x] 4!a2!a2!c	

9 Technical Specifications

- 9.1 SWIFTNet FIN related issues
- 9.1.2 SWIFTNet FIN Messages - Details

SWIFT standard			SSP Specifications		
Status	Field	Field name	Status	Format	Use in SSP
				[3!c] Option F: [/34x] 4*(1!n/33x) no letter option: [/34x] 4*35x	
O	70	Remittance Information	O	4*35x	
O	72	Sender to Receiver Information	O	6*35x	
O	33B	Currency/ Instructed Amount	O	3!a15d	

9.1.2.2.1.5 MT 204

Usage

This message type is used by banks, central banks and ancillary systems to withdraw money from the account of counterparties that agreed on in advance.

The sender of the message is the creditor and the receiver is the debtor.

In case of an Internet-based direct participant as receiver (receiver in the header of the SWIFT message is "TRGTXEPLVP" and BIC of Internet-based direct participant is quoted in field 53 of sequence B) repetitive sequence B can only be used once.

This message cannot be used to pull liquidity from a Dedicated Cash Account in T2S. To initiate such a transfer an MT 202 has to be used.

9 Technical Specifications

- 9.1 SWIFTNet FIN related issues
- 9.1.2 SWIFTNet FIN Messages - Details

Structure

The following table describes the structure of the MT 204:

SWIFT standard			SSP Specifications		
Status	Field	Field name	Status	Format	Use in SSP
Sequence A Common Elements - Reimbursement Details					
M	20	Transaction Reference Number	M	16x	
M	19	Sum of Amounts	M	17d	The amount in field 19 must be equal to the sum of the amounts in all fields 32B. This is the amount actually settled.
M	30	Value Date	M	YYMMDD	The date can be the current business day or up to five TARGET working days in advance.
O	57a	Account With Institution	O	Option A: [/1!a]/34x 4!a2!a2!c [3!c]	Only option A is allowed. Other options are rejected.
O	58a	Beneficiary Institution	O	Option A: [/1!a]/34x 4!a2!a2!c [3!c] Option D: [/1!a]/34x 4*35x	
O	72	Sender to Receiver Information	O	6*35x	PM: The following codes can be used to set an execution time: <ul style="list-style-type: none"> • /TILTIME/hhmm+/-iinn

9 Technical Specifications

- 9.1 SWIFTNet FIN related issues
- 9.1.2 SWIFTNet FIN Messages - Details

SWIFT standard			SSP Specifications		
Status	Field	Field name	Status	Format	Use in SSP
					<ul style="list-style-type: none"> • /FROTIME/hhmm+/-iinn • /REJTIME/hhmm+/-iinn <p>hhmm must be before the cut-off time for bank-to-bank payments (18.00 under normal circumstances)</p> <p>Note: This field has to be filled in according to the SWIFT standard. ii and nn are the hours and minutes of UTC shift whereas the „hhmm“ are to be filled with the local time of the user. This is valid for the code-words TILTIME, REJTIME and FROTIME.</p> <p>If TILTIME and REJTIME are both mentioned only the first one is used by SSP.</p> <p>/ESCBSTAT/ code followed by “21” to be used for setting up or reimbursement of repo operations with the central bank for intraday credit.</p>
----> Repetitive Sequence B - Transaction Details					
M	20	Transaction Reference Number	M	16x	
O	21	Related Reference	O	16x	
M	32B	Transaction Amount	M	3!a15d	The currency must always be euro.

9 Technical Specifications

- 9.1 SWIFTNet FIN related issues
- 9.1.2 SWIFTNet FIN Messages - Details

SWIFT standard			SSP Specifications		
Status	Field	Field name	Status	Format	Use in SSP
M	53a	Debit Institution	M	Option A: [/1!a]/[34x] 4!a2!a2!c [3!c] Option B: [/1!a]/[34x] [35x] Option D: [/1!a]/[34x] 4*35x	
O	72	Sender to Receiver Information	O	6*35x	

9.1.2.2.2 Cash flow management messages

9.1.2.2.2.1 MT 900

Usage

This message type is used to show the account holder the debit entry in the

- RTGS account in PM as a consequence of a liquidity operation, a backup payment made by the account holder, a payment instruction sent by an ancillary system, mandated payment or a liquidity transfer to T2S not initiated via MT 202 or camt.050 sent by the account holder himself (ie standing orders, ICM current orders, MT 202 Mandated Payments or camt.050 sent by another entity on behalf).
- sub-account of an RTGS account in PM as a consequence for a liquidity operation or a payment instruction sent by an ancillary system.

9 Technical Specifications

- 9.1 SWIFTNet FIN related issues
- 9.1.2 SWIFTNet FIN Messages - Details

The message is sent out after debiting took place on the respective account. The booking is confirmed again on the account statement. Debit entries from payments processed via the FIN-copy service of Payments Module (PM) are not confirmed with MT 900. When FIN-copy is not used, issuing of MT 900 is optional (a global parameter can be selected by the participant and a special parameter for T2S related business).

Structure

The following table describes the structure of the MT 900:

SWIFT standard			SSP Specifications		
Status	Field	Field name	Status	Format	Use in SSP
M	20	Transaction Reference Number	M	16x	<p>For payments linked to AS:</p> <ul style="list-style-type: none"> • The TRN is built with “AS” followed by the 8 characters of the timestamp (ddhhmmss) and the last 6 digits of the PM transaction reference (nnnnnn): “ASddhhmmssnnnnnn” <p>For all other payments:</p> <ul style="list-style-type: none"> • The SSP Business Case ID (up to 16 numeric characters)
M	21	Related Reference	M	16x	<p>Content of field 20 (in case of direct debit field 21). For payments linked to AS settlement:</p> <ul style="list-style-type: none"> • Execution of Standing orders and current orders sent via ICM screens (U2A): Internal SSP reference • Execution of LiquidityCredit-Transfer and SBTransferInitiation sent in A2A via ICM: Copy of MessageIdentification • Back Transfer of liquidity ordered with End of Procedure:

9 Technical Specifications

- 9.1 SWIFTNet FIN related issues
- 9.1.2 SWIFTNet FIN Messages - Details

SWIFT standard			SSP Specifications		
Status	Field	Field name	Status	Format	Use in SSP
					<p>Copy of BusinessInformation-Reference of the ReturnGeneralBusinessInformation message or 'NONREF' if End of procedure is triggered on ICM.</p> <ul style="list-style-type: none"> • End of Procedure by SSP at End of Business day: Related internal reference attributed by the SSP specifically to each AS for the procedure which has to be closed by the SSP. • Other cases: Copy of EndToEndIdentification contained in the ASTransferInitiation messages <p>For liquidity transfers to T2S:</p> <ul style="list-style-type: none"> • Initiated via XML message LiquidityCreditTransfer: Copy of EndToEndIdentification • Initiated via MT 202: Copy of field 21 • Execution of standing orders: SSP Business Case ID • Current orders sent via ICM screens (U2A): End-to-end identification, if entered; else: SSP Business Case ID <p>For transactions received via ICM (A2A) the first 16 characters of the MsgId.</p> <p>For transactions received via ICM (U2A) the internal reference. "NEW" for internal payments gen-</p>

9 Technical Specifications

- 9.1 SWIFTNet FIN related issues
- 9.1.2 SWIFTNet FIN Messages - Details

SWIFT standard			SSP Specifications		
Status	Field	Field name	Status	Format	Use in SSP
					erated directly by the SSP modules (SF interest, RM interest and penalties).
M	25	Account Identification	M	35x	Usage up to 34 digit account number related to RTGS main account or sub-account debited for ancillary system.
O	13D	Date, Time Indication		6!n4!n1!x4!n	Not used by SSP

9 Technical Specifications

- 9.1 SWIFTNet FIN related issues
- 9.1.2 SWIFTNet FIN Messages - Details

SWIFT standard			SSP Specifications		
Status	Field	Field name	Status	Format	Use in SSP
M	32A	Value Date, Currency Code, Amount	M	6!n3!a15d	<p>Only current day. Only EUR. Settled amount.</p> <p>If confirmation is sent out due to a credit line decrease initiated by the CB via ICM U2A or A2A (codeword "/CREDITLINE/" in field 72 of MT 900): Amount of the credit line change (delta).</p>
O	52a	Ordering Institution	O	<p>Option A: [!1!a][!34x] 4!a2!a2!c [!3!c]</p>	<p>PM: For the debit entries stemming from the AS settlement depending on their nature, the following BICs are contained:</p> <ul style="list-style-type: none"> • Execution of standing orders and current orders sent by settlement banks via ICM: BIC of the settlement bank • Back Transfer of liquidity ordered with end of procedure: BIC of the AS if procedure was closed via ICM BIC of the AS in field SubjectDetails (if filled) else BIC AS sender of the ReturnGeneral-BusinessInformation. • LiquidityCreditTransfer and SBTransferInitiation BIC of settlement bank • End of Procedure by SSP at End of Business day: BIC TRGTXEPMASI • Other cases:

9 Technical Specifications

- 9.1 SWIFTNet FIN related issues
- 9.1.2 SWIFTNet FIN Messages - Details

SWIFT standard			SSP Specifications		
Status	Field	Field name	Status	Format	Use in SSP
					<p>BIC of the AS in Initiating Party (if filled) else BIC sender of the ATransferInitiation.</p> <p>For the debit entries stemming from liquidity transfers to T2S:</p> <ul style="list-style-type: none"> • LiquidityCreditTransfer: BIC matching to the sender DN - optionally given "works as" BIC in the application header. • Execution of standing orders: BIC of the account holder • Current orders sent via ICM (U2A): BIC of the working user; selected "works as" BIC • MT 202: BIC of the sender
O	72	Sender to Receiver Information	O	6*35x	<p>PM:</p> <ul style="list-style-type: none"> • /BUP/ for backup payments • /LIQUIINP/ for a liquidity transfer • /LIQUIOUT/ for liquidity forwarding from PM (except at the end-of-day) • /LIQUIT2S/ (followed by Dedicated Cash Account number to be credited in T2S) for liquidity transfers to T2S. In case 35 characters per line are exceeded, the account number will be continued in following line starting with //. Example: /LIQUIT2S/CBEEURAAAABEB

9 Technical Specifications

- 9.1 SWIFTNet FIN related issues
- 9.1.2 SWIFTNet FIN Messages - Details

SWIFT standard			SSP Specifications		
Status	Field	Field name	Status	Format	Use in SSP
					<p>BXXXEXAMPLE1 //2345678</p> <ul style="list-style-type: none"> • /CRDTLN/15d to indicate the change of credit line to the user for a connected payment. • /CREDITLINE/ for credit line change via ICM order (U2A and A2A) • /MANPAY/ for mandated payments • /ASDEBT/ used by the AS. See “Normalization of AS code-words for field 72”. Not used in case of standing orders to sub-accounts and current orders to sub-accounts sent via ICM and back transfer of liquidity at end of procedure or end of day. • /ASINF/ used by the AS. See “Normalization of AS code-words for field 72”. Not used in case of standing orders to sub-accounts and current orders to sub-accounts sent via ICM and back transfer of liquidity at end of procedure or end of day. • /SFOVDINT/ for “Overnight Deposit Interest“ • /SFMLAINT/ for “Automatic Marginal Lending Interest“ • /SFMLOINT/ for “Marginal Lending On-Request Interest“ • /RMRESINT/ for “Interest on minimum reserve“

9 Technical Specifications

- 9.1 SWIFTNet FIN related issues
- 9.1.2 SWIFTNet FIN Messages - Details

SWIFT standard			SSP Specifications		
Status	Field	Field name	Status	Format	Use in SSP
					<ul style="list-style-type: none"> • /RMRESPEN/ for “Penalties for infringements“ • /RMRESEXC/ for “Interest on excess of reserve“ • /LIQUISF/ for liquidity transfer to/from standing facilities module The following lines are filled in with one of the 3 string: //AUTOMATIC MARGINAL LENDING 0004 //MARGINAL LENDING ON REQUEST 0004 //OVERNIGHT DEPOSIT 0003 followed in the 3rd line by Debtor and Creditor BIC • /LIQUIEOD/ for liquidity forwarding at the end-of-day • /SSPBIL/ for CRISP TARGET2 fees • /SSPT2SBIL/ for CRISP T2S fees • /BALANCM/ for the confirmation on turnover stemming from ECONS I • /LIQUISOD/ for liquidity transfer at the start-of-day from HAM to PM • Information about the counterpart involved in SF operations is provided in a new line and structured as follows: //DEB BIC1 CRED BIC2 where BIC1 is the BIC of the debited account and BIC2 is the BIC of the credited account

9 Technical Specifications

- 9.1 SWIFTNet FIN related issues
- 9.1.2 SWIFTNet FIN Messages - Details

SWIFT standard			SSP Specifications		
Status	Field	Field name	Status	Format	Use in SSP
					<ul style="list-style-type: none"> • Information regarding reverse operations in SF is provided at the end of the corresponding line with an "R"(eg //OVER-NIGHT DEPOSIT nnnn "R")

9.1.2.2.2.2 MT 910

Usage

This message type is used to show the account holder the credit entry in the

- RTGS account in PM as a consequence of a liquidity operation or a payment instruction sent by an ancillary system.
- sub-account of an RTGS account in PM as a consequence of a liquidity operation or a payment instruction sent by an ancillary system.

The message is sent out after crediting took place on the respective account. The booking is confirmed again on the account statement. Credit entries from payments received via the FIN-copy service of Payments Module (PM) are not confirmed with MT 910.

When FIN-copy is not used, issuing of MT 910 is optional (a global parameter can be selected by the participant).

Structure

The following table describes the structure of the MT 910:

SWIFT standard			SSP Specifications		
Status	Field	Field name	Status	Format	Use in SSP
M	20	Transaction Reference Number	M	16x	For payments linked to AS: The TRN is built with "AS" followed by the 8 characters of the timestamp (ddhhmmss) and the last 6 digits of the PM transaction reference

9 Technical Specifications

- 9.1 SWIFTNet FIN related issues
- 9.1.2 SWIFTNet FIN Messages - Details

SWIFT standard			SSP Specifications		
Status	Field	Field name	Status	Format	Use in SSP
					(nnnnnn): "ASddhhmmsnnnnnn"
M	21	Related Reference	M	16x	<p>Content of field 21 (in case of direct debit field 20). For payments linked to AS settlements:</p> <ul style="list-style-type: none"> • Execution of standing orders and current orders sent via ICM screens (U2A): Internal SSP reference • Execution of LiquidityCredit-Transfer sent in A2A via ICM: Copy of MessageIdentification • Back transfer of liquidity ordered with end of procedure: Copy of BusinessInformation-Reference of the ReturnGeneralBusinessInformation message or 'NONREF' if End of procedure is triggered on ICM • End of procedure by SSP at end of business day: Related internal reference attributed by the SSP specifically to each AS for the procedure which has to be closed by the SSP. • MT 202 to credit sub- or technical account – procedure 6 – real time: Copy of field 20 of the MT 202 • Other cases: Copy of EndToEndIdentification contained in the ASTransferInitiation messages <p>For transactions received via ICM</p>

9 Technical Specifications

- 9.1 SWIFTNet FIN related issues
- 9.1.2 SWIFTNet FIN Messages - Details

SWIFT standard			SSP Specifications		
Status	Field	Field name	Status	Format	Use in SSP
					<p>(A2A) the first 16 characters of the Msgld.</p> <p>For liquidity transfer PHA to PM received via ICM (A2A) the content of field 20 of the FIN message sent by the CB (PHA) initiated by the ICM (A2A) order.</p> <p>For transactions received via ICM (U2A) the internal reference.</p> <p>“NEW” for internal payments generated directly by the SSP modules (SF interest, RM interest and penalties)</p>
M	25	Account Identification	M	35x	Usage up to 34 digit account number related to RTGS main account or sub-account credited for ancillary system.
O	13D	Date, Time Indication		6!n4!n1!x4!n	Not used by SSP
M	32A	Value Date, Currency Code, Amount	M	6!n3!a15d	<p>Only current day.</p> <p>Only EUR.</p> <p>If confirmation is sent out due to a credit line increase initiated by the CB via ICM U2A or A2A (codeword “/CREDITLINE/” in field 72 of MT 910): Amount of the credit line change (delta).</p>
O	50a	Ordering Customer	O	<p>Option A:</p> <p>[/34x]</p> <p>4!a2!a2!c</p> <p>[3!c]</p>	<p>PM:</p> <p>Not used</p>

9 Technical Specifications

9.1 SWIFTNet FIN related issues

9.1.2 SWIFTNet FIN Messages - Details

SWIFT standard			SSP Specifications		
Status	Field	Field name	Status	Format	Use in SSP
				Option F: 35x 4*35x Option K: [/34x] 4*35x	

9 Technical Specifications

- 9.1 SWIFTNet FIN related issues
- 9.1.2 SWIFTNet FIN Messages - Details

SWIFT standard			SSP Specifications		
Status	Field	Field name	Status	Format	Use in SSP
O	52a	Ordering Institution	M	Option A: [1!a]/[34x] 4!a2!a2!c [3!c]	<p>PM: Content of field 52 of the related payment message or its sender of the credited payment. For the credit entries stemming from the AS settlement depending on their nature, the following BICs are contained:</p> <ul style="list-style-type: none"> • MT 202 to sub- or technical account – procedure 6 – real-time, execution of standing orders and current orders sent by the settlement banks via ICM: BIC of the settlement bank • Back transfer of liquidity ordered with end of procedure: BIC of the AS which procedure was closed via ICM BIC of the AS filled in field SubjectDetails (if filled) else BIC AS sender of the ReturnGeneralBusiness-Information. • End of procedure by SSP at End of business day: BIC TRGTXEPMASI • Other cases: BIC of the AS in Initiating party (if filled) else BIC sender of the ASTransferInitiation.
O	56a	Intermediary	O	Option A: [1!a]/[34x] 4!a2!a2!c [3!c]	
O	72	Sender to	O	6*35x	PM:

9 Technical Specifications

- 9.1 SWIFTNet FIN related issues
- 9.1.2 SWIFTNet FIN Messages - Details

SWIFT standard			SSP Specifications		
Status	Field	Field name	Status	Format	Use in SSP
		Receiver Information			<ul style="list-style-type: none"> • /LIQUIINP/ for a liquidity transfer • /LIQUIOUT/ for liquidity forwarding from PM (except at the end-of-day) • /CRDTLN/15d to indicate the change of credit line to the user for a connected payment. • /CREDITLINE/ for credit line change via ICM order (U2A and A2A) • /MANPAY/ for mandated payments • /ASCRED/ used by the AS. See “MT 910”. Not used in case of standing orders to subaccounts and current orders to subaccounts sent via ICM and back transfer of liquidity at end of procedure or end of day. • /ASINF/ used by the AS. See “MT 910”. Not used in case of standing orders to subaccounts and current orders to subaccounts sent via ICM and back transfer of liquidity at end of procedure or end of day. • /SFOVDINT/ for “Overnight Deposit Interest” • /SFMLAINT/ for “Automatic Marginal Lending Interest” • /SFMLOINT/ for “Marginal Lending On-Request Interest” • /RMRESINT/ for “Interest on minimum reserve”

9 Technical Specifications

- 9.1 SWIFTNet FIN related issues
- 9.1.2 SWIFTNet FIN Messages - Details

SWIFT standard			SSP Specifications		
Status	Field	Field name	Status	Format	Use in SSP
					<ul style="list-style-type: none"> • /RMRESPEN/ for “Penalties for infringements“ • /RMRESEXC/ for “Interest on excess of reserve“ • /LIQUISF/ for liquidity transfer to/from standing facilities module The following lines are filled in with one of the 3 string: //AUTOMATIC MARGINAL LENDING 0005 //MARGINAL LENDING ON REQUEST 0005 //OVERNIGHT DEPOSIT 0010 followed in the 3rd line by Debtor and Creditor BIC • /LIQUIEOD/ for liquidity forwarding at the end-of-day • /SSPBIL/ for CRISP TARGET2 fees • /SSPT2SBIL/ for CRISP T2S fees • /BALANCM/ for the confirmation on turnover stemming from ECONS I • /LIQUISOD/ for liquidity transfer at the start-of-day from HAM to PM • Information about the counterpart involved in SF operations is provided in a new line and structured as follows: //DEB BIC1 CRED BIC2 where BIC1 is the BIC of the debited ac-count and BIC2 is the BIC of the credited account

9 Technical Specifications

- 9.1 SWIFTNet FIN related issues
- 9.1.2 SWIFTNet FIN Messages - Details

SWIFT standard			SSP Specifications		
Status	Field	Field name	Status	Format	Use in SSP
					<ul style="list-style-type: none">Information regarding reverse operations in SF is provided at the end of the corresponding line with an "R"(eg //OVER-NIGHT DEPOSIT nnnn "R")

Normalization of AS codewords for field 72

The optional elements (Debtor, Creditor and RemittanceInformation) of the ATransferInitiation and SBTransferInitiation are mapped in the field 72 of the MT 900/910.

For the AS Real-time, the fields 52/58 and 72 of the standing orders and the liquidity transfer to technical account – procedure 6 – real-time are also mapped in the field 72 of the MT 900. For the standing orders and current orders executed via ICM for the AS interfaced, the field 52 of MT 900/910 is filled in with the BIC of the settlement bank and no information is mapped in the field 72.

Specific fields of MT 202 sent by a settlement bank to credit its sub-account or to credit the technical account – procedure 6 – real-time are also mapped in the MT 900/910: Field 20 of the MT 202 is mapped in field 21 of the MT 900/910, Field 52a contains the BIC of the settlement bank, and fields 52 or 58 of the MT 202 are mapped to the field 72 as explained below.

Codewords

If debtor (or field 52) and creditor (or field 58) are filled, they are sent in field 72 with the following codewords:

- In the MT 900: /ASDEBT/ (debtor or 52)
- In the MT 910: /ASCRED/ (creditor or 58)

If RemittanceInformation (field 72) is filled, it is sent in field 72 with the following codeword:

- In MT 900/910: /ASINF/ (RemittanceInformation or 72)

- 9.1 SWIFTNet FIN related issues
- 9.1.2 SWIFTNet FIN Messages - Details

Normalization for codewords /ASDEBT/ and /ASCRED/

Debtor and creditor contain the following optional elements:

- Debtor
 - Name (62x)
 - BIC (11x)
 - DomesticAccountIdentification (35x)
- Creditor
 - Name (62x)
 - BIC (11x)
 - DomesticAccountIdentification (35x)

The separator “+“ is used to distinguish the 3 optional elements of debtor and creditor.

The maximal length of each allowed data combination for debtor or creditor parameters is:

Data combinations	Maximal length
Name+BIC+DomesticAccountIdentification	110x
Name+BIC+	74x
Name+DomesticAccountIdentification	99x
Name++	62x
+BIC+DomesticAccountIdentification	48x
+BIC+	12x
++DomesticAccountIdentification	37x

In case of field 52 or field 58, the data is “+BIC“.

The data relative to debtor and creditor are sent in MT 900/910 without truncation.

These data are always mapped at the beginning of the field 72, according to their length they occupy from the 1st to the 4th line.

9 Technical Specifications

- 9.1 SWIFTNet FIN related issues
- 9.1.2 SWIFTNet FIN Messages - Details

Example with the maximum data length (110x):

```
/ASDEBT/ 27x  
// 33x  
// 33x  
// 17x
```

Normalization for the codeword /ASINF/

The contents of tag RemittanceInformation of the ATransferInitiation, as well as field 72 of the liquidity transfers, are mapped to field 72 of the MT 900/910, following code word /ASINF/.

However, as the field 72 is limited to 6 lines of 35x, the information will be truncated according to a dynamically handling of the remaining lines of field 72 after the codewords /ASDEBT/ or /ASCRED/.

The length of the RemittanceInformation will be from 61 characters to 140 characters according to the number of free lines following /ASDEBT/ or /ASCRED/.

Minimum and maximum lengths of RemittanceInformation	
Minimum: 61 characters (Maximum truncation)	Maximum: 140 characters (No truncation)
/ASDEBT/ 27x	/ASDEBT/ 27x
// 33x	/ASINF/ 28x
// 33x	// 33x
// 17x	// 33x
/ASINF/ 28x	// 33x
// 33x	// 13x

- 9.1 SWIFTNet FIN related issues
- 9.1.2 SWIFTNet FIN Messages - Details

Examples of field 72

Field 72 for MT 900

Tag	M/O	Data
...		
72	O	/ASDEBT/ Bank DEBSPART++123456DBSP/ASINF/Document XYZ

Field 72 for MT 910

Tag	M/O	Data
...		
72	O	/ASCRED/+CREDFRPPXXX+CRED789/ASINF/Document XYZ

9.1.2.2.2.3 MT 940

Usage

This message type is used to show the account holder the bookings in the

- RTGS account in PM
- sub-accounts of the RTGS account
- ECONS I account (in case the Enhanced Contingency Solution has been activated).

Issuing of MT 940 is optional.

9 Technical Specifications

- 9.1 SWIFTNet FIN related issues
- 9.1.2 SWIFTNet FIN Messages - Details

Structure

The following table describes the structure of the MT 940:

SWIFT standard			SSP Specifications		
Status	Field	Field name	Status	Format	Use in SSP
M	20	Transaction Reference Number	M	16x	
O	21	Related Reference	-	-	Must not be used
M	25	Account Identification	M	35x	Usage up to 34 digits; account number related to RTGS main account or sub-account debited by an ancillary system.
M	28C	Statement Number/Sequence Number	M	5n[/5n]	<p>Statement Number: At the beginning of the year and for the first message of a new participant starting with 00001</p> <p>PM: Sequence Number: Starting daily with 00001 In case of overflow of the sequence number on the same business day the statement number increases by 1 and the sequence number starts again from 1.</p>
M	60a	Opening Balance	M	<p>Option F: 1!a6!n3!a15d</p> <p>Option M: 1!a6!n3!a15d</p>	<p>F = First Opening Balance D/C Mark, Date (current business date), Currency, Amount</p> <p>M = Intermediate Opening Balance D/C Mark, Date (current business date), Currency, Amount</p>

9 Technical Specifications

- 9.1 SWIFTNet FIN related issues
- 9.1.2 SWIFTNet FIN Messages - Details

SWIFT standard			SSP Specifications			
---->						
O	61	Statement Line	O	6!n[4!n]2a[1!a]15d1!a3!c16x//[16x][34x]		
				Sub-field	For-mat	PM:
				1	6!n	Value date (YYMMDD)
				2	[4!n]	Business daydate (MMDD)
				3	2a	Characters for Debit/Credit (D or C) Characters for Reversal of Debit/Credit (RD or RC)
				4	[1!a]	Code for money type (not being used)
				5	15d	Amount in euro
				6	1!a3!c	Origination type of turnover (S3!n). 3!n is filled with the respective SWIFT message type (eg S103) AS transactions: “S202“ for transactions sent by a settlement bank (MT 202, SBTransferInitiation, LiquidityCreditTransfer, U2A) to debit its own RTGS account “S204“ for all others operations ordered by a third party (AS, CB or PM) T2S transactions: “S202“ for standing order and current order to T2S initiated via

9 Technical Specifications

- 9.1 SWIFTNet FIN related issues
- 9.1.2 SWIFTNet FIN Messages - Details

SWIFT standard			SSP Specifications			
						<p>MT 202, ICM, camt.050 from user and camt.050 from T2S.</p> <p>“S204“ for camt.051 from T2S</p> <p>TIPS transactions:</p> <p>“S202“for standing order and current order to TIPS initiated via ICM, camt.050 from user and camt.050 from TIPS</p>
				7	16x	<p>Ordering party’s reference (field 20)</p> <p>Origin of payment is within SSP: (eg liquidity retransfer at EoD to HAM, PHA or other participants; EOD settlement on ECB account Levelling out, Liquidity transfer from PM to HAM and PHA during the day or between GoA members, backup payments, internal payments from HAM/SF/RM/ECONS I/ CRISP to PM)</p> <p>reference (field 20) of the internal message</p> <p>if field is not available/filled: PM reference</p> <p>AS transactions:</p> <p>“Tag 20“ for MT 202</p> <p>“Message Identification“ for SBTransferInitiation and LiquidityCreditTransfer</p> <p>“SSP internal reference“ for U2A, standing orders and operations ordered by PM</p>

9 Technical Specifications

- 9.1 SWIFTNet FIN related issues
- 9.1.2 SWIFTNet FIN Messages - Details

SWIFT standard			SSP Specifications			
						<p>“BusinessInformationReference“ for end of procedure requested via ReturnGeneralBusinessInformation</p> <p>“EndToEndIdentification“ for all other cases (requested by ASTransferInitiation)</p> <p>T2S transactions:</p> <p>related reference (field 21) for current order initiated via MT message</p> <p>“EndToEndIdentification“ for current order initiated via XML or initiated via ICM (to/from T2S)</p> <p>PM reference for standing order if field is not available/filled: PM reference</p> <p>TIPS transactions:</p> <p>“EndToEndIdentification“ for current order initiated via XML or initiated via ICM (to/from TIPS)</p> <p>PM reference for standing order if field is not available/filled: PM reference</p>
				8	[/16x]	<p>Reference for the institution maintaining the account: SSP internal posting reference for unique identification</p> <p>AS transactions:</p> <p>“SSP internal Reference“</p>
				9	[34x]	<BIC of the sender from the SWIFT

9 Technical Specifications

- 9.1 SWIFTNet FIN related issues
- 9.1.2 SWIFTNet FIN Messages - Details

SWIFT standard			SSP Specifications		
					<p>Header> /<settlement time HHMMSS>[/<BIC from field 52 or the first characters of field 52D >] optional[/BUP/] optional; only for backup payments [/MANPAY/] optional; only for mandated payments</p> <p>Origin of payment is within SSP: <PM BIC> for payments initiated by PM (eg liquidity retransfer at EoD to HAM, PHA or other partici- pants, EOD settlement on ECB account levelling out)</p> <p><BIC customer of ICM request> for payments initiated via ICM (eg liquidity transfer from PM to HAM and PHA during the day or be- tween GoA members, backup payments)</p> <p><BIC of field 53 of the internal message> for internal payments from HAM/SF/RMECONS I/CRISP to PM</p> <p>AS transactions: <SB BIC>/HHMMSS for “S202” messages <PM BIC>/HHMMSS for standing orders and for emergency proce- dure launched automatically by PM (ex: if End of Procedure has not been sent by the AS before the end of day) <AS BIC>/HHMMSS for messages sent by AS <CB BIC>/HHMMSS/<AS BIC> for</p>

9 Technical Specifications

- 9.1 SWIFTNet FIN related issues
- 9.1.2 SWIFTNet FIN Messages - Details

SWIFT standard			SSP Specifications		
					<p>messages sent by CB on behalf of the AS</p> <p>T2S transactions: <BIC sender>/HHMMSS for payments initiated by a participant <PM BIC>/HHMMSS for standing orders and reversal bookings TRGTXEPMBAH/HHMMSS for camt.050/camt.051 from T2S</p> <p>TIPS transactions: <BIC sender>/HHMMSS for payments initiated by a participant <PM BIC>/HHMMSS for standing orders and reversal bookings <TIPS-BIC>/HHMMSS for camt.050 from TIPS</p> <p>Note: The postings (debit entries and credit entries) are sorted in ascending order of the amount.</p>
O	86	Information to Account Owner	O	6*65x	Not used by the SSP

M	62a	Closing Balance (Booked Funds)	M	Option F: 1!a6!n3!a15d Option M: 1!a6!n3!a15d	F = Final Closing Balance D/C Mark, Date (current business date), Currency, Amount M = Intermediate Closing Balance D/C Mark, Date (current business date), Currency, Amount
O	64	Closing Available	O	1!a6!n3!a15d	Not used by the SSP

9 Technical Specifications

- 9.1 SWIFTNet FIN related issues
- 9.1.2 SWIFTNet FIN Messages - Details

SWIFT standard			SSP Specifications		
		Balance (Available Funds)			
----->					
O	65	Forward Available Balance	O	1!a6!n3!a15d	Not used by the SSP

O	86	Information to Account Owner	O	6*65x	Not used by the SSP

9.1.2.2.2.4 MT 950

Usage

This message type is used to show the account holder the bookings in the

- RTGS account in PM.
- Sub-accounts of an RTGS account.
- ECONS I account (in case the Enhanced Contingency Solution has been activated).

Issuing of MT 950 is optional.

Structure

The following table describes the structure of the MT 950:

SWIFT standard			SSP Specifications		
Status	Field	Field name	Status	Format	Use in SSP
M	20	Transaction Reference Number	M	16x	-

9 Technical Specifications

- 9.1 SWIFTNet FIN related issues
- 9.1.2 SWIFTNet FIN Messages - Details

SWIFT standard			SSP Specifications			
Status	Field	Field name	Status	Format	Use in SSP	
M	25	Account Identification	M	35x	Usage up to 34 digits; account number related to RTGS main account or sub-account debited by an ancillary system.	
M	28C	Statement Number/Sequence Number	M	5n/[5n]	<p>Statement Number: At the beginning of the year and for the first message of a new participant starting with 00001</p> <p>PM: Sequence Number: Starting daily with 00001 In case of overflow of the sequence number on the same business day the statement number increases by 1 and the sequence number starts again from 1.</p>	
M	60a	Opening Balance	M	<p>Option F: 1!a6!n3!a15d</p> <p>Option M: 1!a6!n3!a15d</p>	<p>F = First Opening Balance D/C Mark, Date (current business date), Currency, Amount</p> <p>M = Intermediate Opening Balance D/C Mark, Date (current business date), Currency, Amount</p>	
---->						
O	61	Statement Line	O	6!n[4!n]2a[1!a]15d1!a3!c16x[/16x][34x]		
				Sub-field	Format	
				1	6!n	PM: Value date (YYMMDD)

9 Technical Specifications

- 9.1 SWIFTNet FIN related issues
- 9.1.2 SWIFTNet FIN Messages - Details

SWIFT standard			SSP Specifications		
Status	Field	Field name	Status	Format	Use in SSP
				2 [4!n]	Business daydate (MMDD)
				3 2a	<ul style="list-style-type: none"> • Characters for Debit/Credit (D or C) • Characters for Reversal of Debit/Credit (RD or RC)
				4 [1!a]	Code for money type (not being used)
				5 15d	Amount in euro
				6 1!a3!c	<p>Origination type of turnover (S3!n). 3!n is filled with the respective SWIFT message type (eg S103)</p> <p>AS transactions: “S202“ for transactions sent by a settlement bank (MT 202, SBTransferInitiation, LiquidityCreditTransfer, U2A) to debit its own RTGS account “S204“ for all others operations ordered by a third party (AS, CB or PM)</p> <p>T2S transactions: “S202“ for standing order and current order to T2S initiated via MT 202, ICM, camt.050 from user and camt.050 from T2S. “S204“ for camt.051 from T2S</p> <p>TIPS transactions: “S202“ for standing order and current order to TIPS initiated via ICM, camt.050 from user and camt.050 from TIPS</p>

9 Technical Specifications

- 9.1 SWIFTNet FIN related issues
- 9.1.2 SWIFTNet FIN Messages - Details

SWIFT standard			SSP Specifications		
Status	Field	Field name	Status	Format	Use in SSP
				7 16x	<p>Ordering party's reference (field 20)</p> <p>Origin of payment is within SSP: (eg liquidity retransfer at EoD to HAM, PHA or other participants; EOD settlement on ECB account levelling out, Liquidity transfer from PM to HAM and PHA during the day or between GoA members, backup payments, internal payments from HAM/SF/RM/ECONS I/ CRISP to PM)</p> <ul style="list-style-type: none"> • reference (field 20) of the internal message • if field is not available/filled: PM reference <p>AS transactions:</p> <ul style="list-style-type: none"> • "Tag 20" for MT 202 • "Message Identification" for SBTransferInitiation and LiquidityCreditTransfer • "SSP internal reference" for U2A, standing orders and operations ordered by PM • "BusinessInformationReference" for end of procedure requested via ReturnGeneral-BusinessInformation • "EndToEndIdentification" for all other cases (requested by ASTransferInitiation) <p>T2S transactions:</p> <ul style="list-style-type: none"> • related reference (field 21) for

9 Technical Specifications

- 9.1 SWIFTNet FIN related issues
- 9.1.2 SWIFTNet FIN Messages - Details

SWIFT standard			SSP Specifications		
Status	Field	Field name	Status	Format	Use in SSP
					current order initiated via MT message <ul style="list-style-type: none"> • “EndToEndIdentification“ for current order initiated via XML or initiated via ICM (to/from T2S) • PM reference for standing order • if field is not available/filled: PM reference TIPS transactions: <ul style="list-style-type: none"> • “EndToEndIdentification“ for current order initiated via XML or initiated via ICM (to/from TIPS) • PM reference for standing order • if field is not available/filled: PM reference
				8	[/16x] Reference for the institution maintaining the account: SSP internal posting reference for unique identification AS transactions: “SSP internal Reference“
				9	[34x] <BIC of the sender from the SWIFT Header> /<settlement time HHMMSS>[/<BIC from field 52 or the first characters of field 52D >] optional; [/BUP/] optional; only for backup payments [MANPAY/] optional; only for mandated payments

9 Technical Specifications

- 9.1 SWIFTNet FIN related issues
- 9.1.2 SWIFTNet FIN Messages - Details

SWIFT standard			SSP Specifications		
Status	Field	Field name	Status	Format	Use in SSP
					<p>Origin of payment is within SSP: <PM BIC> for payments initiated by PM (eg liquidity retransfer at EoD to HAM, PHA or other participants, EOD settlement on ECB account levelling out)</p> <p><BIC customer of ICM request> for payments initiated via ICM (eg liquidity transfer from PM to HAM and PHA during the day or between GoA members, backup payments)</p> <p><BIC of field 53 of the internal message> for internal payments from HAM/SF/RM/ECONS I/CRISP to PM</p> <p>AS transactions: <SB BIC>/HHMMSS for "S202" messages <PM BIC>/HHMMSS for standing orders and for emergency procedure launched automatically by PM (ex: if End of Procedure has not been sent by the AS before the end of day) <AS BIC>/HHMMSS for messages sent by AS <CB BIC>/HHMMSS/<AS BIC> for messages sent by CB on behalf of the AS</p> <p>T2S transactions: <BIC sender>/HHMMSS for payments initiated by a participant <PM BIC>/HHMMSS for standing</p>

9 Technical Specifications

- 9.1 SWIFTNet FIN related issues
- 9.1.2 SWIFTNet FIN Messages - Details

SWIFT standard			SSP Specifications		
Status	Field	Field name	Status	Format	Use in SSP
					orders and reversal bookings TRGTXEPMBAH/HHMMSS for camt.050/camt.051 from T2S TIPS transactions: <BIC sender>/HHMMSS for payments initiated by a participant <PM BIC>/HHMMSS for standing orders and reversal bookings <TIPS-BIC>/HHMMSS for camt.050 from TIPS Note: The postings (debit entries and credit entries) are sorted in ascending order of the amount.

M	62a	Closing Balance (Booked Funds)	M	Option F: 1!a6!n3!a15d Option M: 1!a6!n3!a15d	F = Final Closing BalanceD/C Mark, Date (current business date), Currency, Amount M = Intermediate Closing BalanceD/C Mark, Date (current business date), Currency, Amount
O	64	Closing Available Balance (Available Funds)	O	1!a6!n3!a15d	Not used by the SSP

- 9.1 SWIFTNet FIN related issues
- 9.1.2 SWIFTNet FIN Messages - Details

9.1.2.3 SWIFT system messages

9.1.2.3.1 MT 012

Usage

This message type is used to show the sender of a payment message that the payment has been released by the Payments Module (PM). An MT 012 is always sent by the SWIFT system.

If a MT 202 is used to pull liquidity from T2S, the MT 012 will not confirm settlement in TARGET2 but it will indicate that the transfer order has been forwarded and - possibly partially - settled in T2S. Settlement on the RTGS account is only done after reception of the LiquidityCreditTransfer XML message from T2S. The only reference in this LiquidityCreditTransfer from T2S, which refers to the instructing message sent by TARGET2 (EndToEndId) may not be unique. Therefore, PM cannot check correlation with an existing business case. Consequently, the account owner has to check his RTGS booking entries if the expected credit entry has been settled. He may use ICM screens or GetTransaction XML requests for this.

For each payment, the presenting party can specify whether an MT 012 is required. In field 113, the flag in the second byte of the user header of the relevant payment must be set to "Y" (= MT 012 required) or "N" (= MT 012 not required).

If the presenting party leaves the field blank, an MT 012 is issued as standard. It is also issued even if the flag is set to "N" by the sender, if the message is used for initiation of pull liquidity transfer from T2S and if the payment is only partially executed by T2S. So this important information is always reported via an MT 012.

Structure

The following table describes the structure of the MT 012:

SWIFT standard			SSP Specifications		
Status	Field	Field name	Status	Format	Use in SSP
M	175	Time	M	HHMM	Input time of the original user message local to the sender.

9 Technical Specifications

- 9.1 SWIFTNet FIN related issues
- 9.1.2 SWIFTNet FIN Messages - Details

SWIFT standard			SSP Specifications		
Status	Field	Field name	Status	Format	Use in SSP
M	106	MIR	M	6!n4!a2!a2!c1!c3!c4!n6!n	MIR, identifying the sender's Copy message copied to the PM and released by PM.
O	108	MUR	O	16x	Optional MUR, identifying the sender's copymessage copied to the PM and released by PM.
M	102	SWIFT Ad- dress	M	4!a2!a2!c1!c3!c	Destination of the sender's message
M	103	Service Code	M	TGT	
M	114	Payment Release Information- Sender	M	either 6!n 6!n 2!a 16x or: 6!n 4!c 16n	(SWIFT format: 32x) Regular TARGET2 usage: <ul style="list-style-type: none"> • Credit time HHMMSS, • Debit time HHMMSS, • Country code of sender, • Reference of original payment message In case "Pull liquidity from T2S": <ul style="list-style-type: none"> • T2S Receipt entry time HHMMSS • T2S settlement status: "SSET" (settled) or "SPAS" (partially settled) • SSP Business Case ID

9.1.2.3.2 MT 019

Usage

This message type is used to show the sender that the message could not be passed on to the receiver. An MT 019 is always sent by the SWIFT system.

Returning the message can either be initiated by the SWIFT system or PM. The reason for the return is specified by an error code in MT 019.

The receipt of MT 019 cannot be precluded.

In certain select situations the SSP has accepted to settle the transaction, but SWIFT is not able to deliver the original message to the intended receiver.

The sender is aware because SWIFT generates an MT 019 containing one the following error codes:

- 11 Message is too old, but was authorised
- 12 Too many delivery attempts, but message was authorised
- 13 Destination is disabled, but message was authorised
- 14 Message is too long, but was authorised

Therefore should the sender receive an MT 019 with the above mentioned error codes, the payment has to be considered settled by the SSP. It should also be highlighted that there is no guarantee that the MT 012, if requested, will arrive before the MT 019.

Should the above situation happen (whatever the underlying reason) then the sender must contact the National Service Desk that will take care of informing the receiver and the SSP Operational Team.

9 Technical Specifications

- 9.1 SWIFTNet FIN related issues
- 9.1.2 SWIFTNet FIN Messages - Details

Structure

The following table describes the structure of the MT 019:

SWIFT standard			SSP Specifications		
Status	Field	Field name	Status	Format	Use in SSP
M	175	Time	M	HHMM	Input time of the aborted message local to the sender.
M	106	MIR	M	6!n8!c4!c4!n6!n	MIR, identifying the aborted message.
O	108	MUR	O	16x	The MUR identify the aborted message (if present). If no MUR was present: <ul style="list-style-type: none"> • tag 108 will contain the contents of field 20 of the original message when the alphabetical characters used were all in upper case • tag 108 will not be present, when contents of field 20 could not be used
M	102	SWIFT Address	M	4!a2!a2!c1!c3!c	Destination of the aborted message

- 9.1 SWIFTNet FIN related issues
- 9.1.2 SWIFTNet FIN Messages - Details

SWIFT standard			SSP Specifications		
Status	Field	Field name	Status	Format	Use in SSP
O	107	MOR	O	6!n8!c4!c4!n6!n	MOR identifying the aborted message. If several delivery attempts have been made, field 107 contains the last valid MOR.
M	432	Abort Reason	M	2!c	Abort reason (specified in the SWIFT manual FIN error codes) or reason for the message being rejected by PM.
O	619	VAS code	M	3!x	FIN Copy service code: code of field TAG 103 of the aborted message

9.1.2.4 Examples for addressing payments

Addresses in TARGET2

Since the FIN Y-copy service is used, payments from a SWIFT-based participant will be addressed to the receiving SWIFT-based direct PM participant by indicating the BIC in the respective field of the header. SWIFT payments for Internet-based direct PM participants will be addressed to the BIC “TRGTXEPMLVP” dedicated to the Internet connection and the BIC of the receiving Internet-based direct PM participant will be quoted in Block 4 of the SWIFT message. Payments for indirect PM participants will have to be sent, in general, to the respective direct PM participant. The information needed for the correct addressing is provided in the TARGET2 directory (see chapter [9.4 TARGET2 directory, page 603](#)).

Internet-based participants will use specific screens in ICM for issuing Y-copy payments to other direct PM participants (SWIFT- or Internet-based).

- 9.1 SWIFTNet FIN related issues
- 9.1.2 SWIFTNet FIN Messages - Details

The following table shows details of the recipient's address in the SWIFT Application Header of the payment record from a PM participant's point of view.

Receiving party	Address
SWIFT-based direct PM participant	BIC of the direct PM participant Note: It is possible that the direct PM participant sends and receives payments from another location using a different BIC (technical reasons).
Internet-based direct PM participant	Special BIC of PM dedicated for Internet-based participants "TRGTXEPLVP"
indirect PM participant	BIC of the respective SWIFT-based direct PM participant
proprietary home account holder	BIC of the respective CB

In the following examples the BIC listed below are used:

BIC	Explanation
BKAAFRPPXXX	SWIFT-based direct PM participant (co-manager)
BKEEFRPPXXX	SWIFT-based direct PM participant
BKBBITRRXXX	SWIFT-based direct PM participant (co-manager)
BKCCDEFFXXX	SWIFT-based direct PM participant
BKDDDEDDXXX	SWIFT-based direct PM participant
BKIIDEF1XXX	Internet-based direct PM participant
BKKKDEF1XXX	Internet-based direct PM participant

9 Technical Specifications

- 9.1 SWIFTNet FIN related issues
- 9.1.2 SWIFTNet FIN Messages - Details

BIC	Explanation
BKCCDEFF425	Second BIC used by the SWIFT-based direct PM participant (BKCCDEFFXXX) to send and receive messages at an other location (for technical reasons)
BKBBITRR321	Second BIC used by the SWIFT-based direct PM participant (BKBBITRRXXX) to send and receive messages at an other location (for technical reasons)
BKDDDEM1XXX	Indirect PM participant (related SWIFT-based direct PM participant BKDDDEDDXXX)
BKHHFRP1XXX	Indirect PM participant (related SWIFT-based direct PM participant BDCCDEFFXXX)
BKLLITROXXX	Indirect PM participant (related SWIFT-based direct PM participant BKBBITRRXXX)
BKFFITAAXXX	Central bank customer with an account in HAM (related to Banca d'Italia)
BKOOITKKXXX	Central bank customer with an account in HAM (related to Banca d'Italia)
NCBKLULUXXX	CB with proprietary home accounting system
BKFFLULUXXX	Account holder in proprietary home accounting system

9.1.2.4.1 Payments among PM participants

In the following examples the SWIFT-based direct PM participant (BKAAFRPP) sends the SWIFT message (MT 202).

Sender SWIFT-based direct PM participant

9 Technical Specifications

- 9.1 SWIFTNet FIN related issues
- 9.1.2 SWIFTNet FIN Messages - Details

Case	Receiver	Field entry	Effect
1	SWIFT-based direct PM participant BKBBIT-RRXXX	S: BKAAFRPPXXX R: BKBBITRRXXX 52: 56: 57: 58: BKBBITRRXXX	<ul style="list-style-type: none"> • Debit entry in the RTGS account in PM of BKAAFRPPXXX • Credit entry in the RTGS account in PM of BKBBITRRXXX
2	Internet-based direct PM participant BKIIDEF1XXX	S: BKAAFRPPXXX R: TRGTXEPMLVP 52: 56: 57: 58: BKIIDEF1XXX	<ul style="list-style-type: none"> • Debit entry in the RTGS account in PM of BKAAFRPPXXX • Credit entry in the RTGS account in PM of BKIIDEF1XXX
3	Second BIC of a SWIFT-based direct PM participant (BKCCDEFF425), BIC of the related direct PM participant BKCCDEFFXXX	S: BKAAFRPPXXX R: BKCCDEFF425 52: 56: 57: 58: BKCCDEFF425	<ul style="list-style-type: none"> • Debit entry in the RTGS account in PM of BKAAFRPPXXX • Credit entry in the RTGS account in PM of BKCCDEFFXXX
4	Indirect PM participant BKDDDEM1XXX, SWIFT-based direct PM participant BKDDDEDDXXX	S: BKAAFRPPXXX R: BKDDDEDDXXX 52: 56: 57: 58: BKDDDEM1XXX	<ul style="list-style-type: none"> • Debit entry in the RTGS account in PM of BKAAFRPPXXX • Credit entry in the RTGS account in PM of BKDDDEDDXXX

Note: If the receiving party is an Internet-based participant (ie the payment is addressed to TRGTXEPMLVP), the BIC of first filled field 56-58 (in case of MT 103/202) or field 53 (in case of MT 204) must be a BIC of an Internet-based participant.

In the following examples the Internet-based direct PM participant (BKIIDEF1XXX) issues a payment (MT 202) via the Internet access.

Originator is Internet-based direct PM participant

9 Technical Specifications

- 9.1 SWIFTNet FIN related issues
- 9.1.2 SWIFTNet FIN Messages - Details

Case	Receiver	Field entry	Effect
5	SWIFT-based direct PM participant BKBBIT-RRXXX	S: TRGTXEPLVP R: BKBBITRRXXX 52: BKIIDEF1XXX 56: 57: 58: BKBBITRRXXX	<ul style="list-style-type: none"> • Debit entry in the RTGS account in PM of BKIIDEF1XXX • Credit entry in the RTGS account in PM of BKBBITRRXXX
6	Internet-based direct PM participant BKKK-DEF1XXX	no SWIFT message	<ul style="list-style-type: none"> • Debit entry in the RTGS account in PM of BKIIDEF1XXX • Credit entry in the RTGS account in PM of BKKKDEF1XXX
7	Second BIC of a SWIFT-based direct PM participant (BKBBITRR321), BIC of the related direct PM participant BKBBIT-RRXXX	S: TRGTXEPLVP R: BKBBITRR321 52: BKIIDEF1XXX 56: 57: 58: BKBBITRR321	<ul style="list-style-type: none"> • Debit entry in the RTGS account in PM of BKIIDEF1XXX • Credit entry in the RTGS account in PM of BKBBITRRXXX
8	Indirect PM participant BKHHFRP1XXX, related SWIFT-based direct PM participant BKCCDEFFXXX	S: TRGTXEPLVP R: BKCCDEFFXXX 52: BKIIDEF1XXX 56: 57: 58: BKHHFRP1XXX	<ul style="list-style-type: none"> • Debit entry in the RTGS account in PM of BKIIDEF1XXX • Credit entry in the RTGS account in PM of BKCCDEFFXXX

Note: If the receiving party is an Internet-based participant (ie the payment is addressed to TRGTXEPLVP), the BIC of first filled field 56-58 (in case of MT 103/202) or field 53 (in case of MT 204) must be a BIC of an Internet-based participant.

In the following examples the SWIFT-based direct PM participant uses a second BIC (BKCCDEFF425) for sending the SWIFT message (MT 202).

Sender is SWIFT-based direct PM participant using a second BIC

9 Technical Specifications

- 9.1 SWIFTNet FIN related issues
- 9.1.2 SWIFTNet FIN Messages - Details

Case	Receiver	Field entry	Effect
9	SWIFT-based direct PM participant BKBBIT-RRXXX	S: BKCCDEFF425 R: BKBBITRRXXX 52: 56: 57: 58: BKIIDEF1XXX	<ul style="list-style-type: none"> • Debit entry in the RTGS account in PM of BKCCDEFFXXX • Credit entry in the RTGS account in PM of BKIIDEF1XXX
10	Internet-based direct PM participant BKIIDEF1XXX	S: BKCCDEFF425 R: TRGTXEPLVP 52: 56: 57: 58: BKIIDEF1XXX	<ul style="list-style-type: none"> • Debit entry in the RTGS account in PM of BKCCDEFFXXX • Credit entry in the RTGS account in PM of BKIIDEF1XXX
11	Second BIC of a SWIFT-based direct PM participant (BKBBITRR321), BIC of related direct PM participant BKBBIT-RRXXX	S: BKCCDEFF425 R: BKBBITRR321 52: 56: 57: 58: BKBBITRR321	<ul style="list-style-type: none"> • Debit entry in the RTGS account in PM of BKCCDEFFXXX • Credit entry in the RTGS account in PM of BKBBITRRXXX
12	Indirect PM participant BKDDDEM1XXX, SWIFT-based direct PM participant BKDDDEDDXXX	S: BKCCDEFF425 R: BKDDDEDDXXX 52: 56: 57: 58: BKDDDEM1XXX	<ul style="list-style-type: none"> • Debit entry in the RTGS account in PM of BKCCDEFFXXX • Credit entry in the RTGS account in PM of BKDDDEDDXXX

Note: If the receiving party is an Internet-based participant (ie the payment is addressed to TRGTXEPLVP), the BIC of first filled field 56-58 (in case of MT 103/202) or field 53 (in case of MT 204) must be a BIC of an Internet-based participant.

In the following examples the indirect PM participant (BKDDDEM1XXX) orders the SWIFT-based direct PM participant (BKDDDEDDXXX) to send the SWIFT message (MT 202).

Originator is indirect PM participant

9 Technical Specifications

- 9.1 SWIFTNet FIN related issues
- 9.1.2 SWIFTNet FIN Messages - Details

Case	Receiver	Field entry	Effect
13	SWIFT-based direct PM participant BKBBIT-RRXXX	S: BKDDDEDDXXX R: BKBBITRRXXX 52: BKDDDEM1XXX 56: 57: 58: BKBBITRRXXX	<ul style="list-style-type: none"> • Debit entry in the RTGS account in PM of BKDDDEDDXXX • Credit entry in the RTGS account in PM of BKBBITRRXXX
14	Internet-based direct PM participant BKIIDEF1XXX	S: BKDDDEDDXXX R: TRGTXEPLVP 52: BKDDDEM1XXX 56: 57: 58: BKIIDEF1XXX	<ul style="list-style-type: none"> • Debit entry in the RTGS account in PM of BKDDDEDDXXX • Credit entry in the RTGS account in PM of BKIIDEF1XXX
15	Second BIC of a SWIFT-based direct PM participant (BKBBITRR321), BIC of related direct PM participant BKBBIT-RRXXX	S: BKDDDEDDXXX R: BKBBITRR321 52: BKDDDEM1XXX 56: 57: 58: BKBBITRR321	<ul style="list-style-type: none"> • Debit entry in the RTGS account in PM of BKDDDEDDXXX • Credit entry in the RTGS account in PM of BKBBITRRXXX
16	Indirect PM participant BKHHFRP1XXX, related SWIFT-based direct PM participant BKCCDEFFXXX	S: BKDDDEDDXXX R: BKCCDEFFXXX 52: BKDDDEM1XXX 56: 57: 58: BKHHFRP1XXX	<ul style="list-style-type: none"> • Debit entry in the RTGS account in PM of BKDDDEDDXXX • Credit entry in the RTGS account in PM of BKCCDEFFXXX

Note: If the receiving party is an Internet-based participant (ie the payment is addressed to TRGTXEPLVP), the BIC of first filled field 56-58 (in case of MT 103/202) or field 53 (in case of MT 204) must be a BIC of an Internet-based participant.

9 Technical Specifications

- 9.1 SWIFTNet FIN related issues
- 9.1.2 SWIFTNet FIN Messages - Details

Transfer of liquidity between the RTGS main account and a sub-account (same participant)

In the following example the SWIFT-based direct PM participant (BKEEFRPP) sends a SWIFT message (MT 202) to transfer liquidity to his sub-account.

Case	Receiver	Field entry	Effect
17	Sub-account of the SWIFT-based direct PM participant BKEEFRPPXXX	S: BKEEFRPPXXX R: TRGTXEPMASI 52: BKEEFRPPXXX 56: 57: 58: /FR123456789 BKEEFRPPXXX	<ul style="list-style-type: none">• Debit entry in the RTGS main account of BKEEFRPPXXX• Credit entry in the subaccount of BKEEFRPPXXX

Note: An Internet-based participant can transfer liquidity to his sub accounts via the ICM functionality Enter Liquidity Transfer. It will not be possible to address an MT 202 to the sub accounts via the Enter credit transfer screens. Therefore no FIN payment flow will take place in that case.

9.1.2.4.2 Payments between HAM and PM

Sender SWIFT-based direct PM participant

In the following example the SWIFT-based direct PM participant (BKAADRPP) sends the SWIFT message (MT 202).

Case	Receiver	Field entry	Effect
18	CB customer with account BKFFITAAXX	S: BKAADRPPXXX R: TRGTXECBITX 52: 56: 57: 58: BKFFITAAXX	<ul style="list-style-type: none">• Debit entry in the RTGS account in PM of BKAADRPPXXX• Credit entry in the RTGS account of the central bank customer's CB

9 Technical Specifications

- 9.1 SWIFTNet FIN related issues
- 9.1.2 SWIFTNet FIN Messages - Details

Originator is Internet-based direct PM participant

Note: The payment will be delivered to HAM via SWIFT. In HAM the account of the central bank customer's CB will be debited and the account of the central bank customer will be credited.

In the following example the Internet-based direct PM participant (BKIIDDEF1XXX) issues a payment (MT 202) in ICM.

Case	Receiver	Field entry	Effect
19	CB customer with account BKFFITAAXXX	S: TRGTXEPMLVP R: TRGTXECBITX 52: BKIIDDEF1XXX 56: 57: 58: BKFFITAAXXX	<ul style="list-style-type: none">• Debit entry in the RTGS account in PM of BKIIDDEF1XXX• Credit entry in the RTGS account of the central bank customer's CB

Note: The payment will be delivered to HAM via SWIFT. In HAM the account of the central bank customer's CB will be debited and the account of the central bank customer will be credited.

In the following example the SWIFT-based direct PM participant (BKCCDEFFXXX) uses a second BIC (BKCCDEFF425) for sending SWIFT messages (MT 202).

Case	Receiver	Field entry	Effect
20	CB customer with account BKFFITAAXXX	S: BKCCDEFF425 R: TRGTXECBITX 52: 56: 57: 58: BKFFITAAXXX	<ul style="list-style-type: none">• Debit entry in the RTGS account in PM of BKCCDEFFXXX• Credit entry in the RTGS account in PM of the central bank customer's CB

Sender is direct PM participant using a second BIC

9 Technical Specifications

- 9.1 SWIFTNet FIN related issues
- 9.1.2 SWIFTNet FIN Messages - Details

Originator is indirect PM participant

Note: The payment will be delivered to HAM via SWIFT. In HAM the account of the central bank customer's CB will be debited and the account of the central bank customer will be credited.

In the following example the indirect PM participant (BKHHFRP1XXX) orders its related SWIFT-based direct PM participant (BKCCDEFFXXX) to send the SWIFT message (MT 202).

Case	Receiver	Field entry	Effect
21	CB customer with account BKFFITAAXXX	S: BKCCDEFFXXX R: TRGTXECBITX 52: BKHHFRP1XXX 56: 57: 58: BKFFITAAXXX	<ul style="list-style-type: none">• Debit entry in the RTGS account in PM of BKCCDEFFXXX• Credit entry in the RTGS account in PM of the central bank customer's CB

Note: The payment will be delivered to HAM via SWIFT. In HAM the account of the central bank customer's CB will be debited and the account of the central bank customer will be credited.

In the following examples the central bank customer (BKFFITAAXXX) sends the SWIFT message (MT 202).

Sender central bank customer

9 Technical Specifications

- 9.1 SWIFTNet FIN related issues
- 9.1.2 SWIFTNet FIN Messages - Details

Case	Receiver	Field entry	Effect
22	SWIFT-based direct PM participant BKBBIT-RRXXX	S: BKFFITAAXXX R: TRGTXECEBITX 52: 56: 57: 58: BKBBITRRXXX	<ul style="list-style-type: none"> • Debit entry in the HAM account of BKF-FITAAXXX • Credit entry in the HAM account of the central bank customer's CB
23	Internet-based direct PM participant BKIIDF1XXX	S: BKFFITAAXXX R: TRGTXECEBITX 52: 56: 57: 58: BKIIDF1XXX	<ul style="list-style-type: none"> • Debit entry in the HAM account of BKF-FITAAXXX • Credit entry in the HAM account of the central bank customer's CB
24	Second BIC of a SWIFT-based direct PM participant (BKBBITRR321), BIC of the related direct PM participant BKBBIT-RRXXX	S: BKFFITAAXXX R: TRGTXECEBITX 52: 56: 57: 58: BKBBITRR321	<ul style="list-style-type: none"> • Debit entry in the HAM account of BKF-FITAAXXX • Credit entry in the HAM account of the central bank customer's CB
25	Indirect PM participant BKLLITROXXX	S: BKFFITAAXXX R: TRGTXECEBITX 52: 56: 57: 58: BKLLITROXXX	<ul style="list-style-type: none"> • Debit entry in the HAM account of BKF-FITAAXXX • Credit entry in the HAM account of the central bank customer's CB

Note: In PM the RTGS account of the CB will be debited and the account of the receiving/related direct participant will be credited.

If the receiving party is an Internet-based participant, the BIC of first filled field 56-58 must be a BIC of an Internet-based participant.

9.1.2.4.3 Payments with proprietary home accounts

In the following example the SWIFT-based direct PM participant (BKAAFRPPXXX) sends the SWIFT message (MT 202).

Case	Receiver	Field entry	Effect
26	Account holder in the PHA BKFFLULUXXX	S: BKAAFRPPXXX R: NCBKLULUXXX 52: 56: 57: 58: BKFFLULUXXX	<ul style="list-style-type: none"> • Debit entry in the RTGS account in PM of BKAAFRPPXXX • Credit entry in the PM of NCBKLULUXXX

Note: In the proprietary home accounting system the account of the CB will be debited and the account of the account holder in the proprietary home accounting system (BKFFLULUXXX) will be credited.

In the following example the Internet-based direct PM participant (BKIIDEF1XXX) issues a payment (MT 202) in ICM via the Internet access.

Case	Receiver	Field entry	Effect
27	Account holder in the PHA BKFFLULUXXX	S: BKAAFRPPXXX R: NCBKLULUXXX 52: 56: 57: 58: BKFFLULUXXX	<ul style="list-style-type: none"> • Debit entry in the RTGS account in PM of BKAAFRPPXXX • Credit entry in the PM of NCBKLULUXXX

Note: In the proprietary home accounting system the account of the CB will be debited and the account of the account holder in the proprietary home accounting system (BKFFLULUXXX) will be credited.

Sender SWIFT-based direct PM participant

Originator is Internet-based direct PM participant

9 Technical Specifications

- 9.1 SWIFTNet FIN related issues
- 9.1.2 SWIFTNet FIN Messages - Details

Sender SWIFT-based direct PM participant using a second BIC

In the following example the SWIFT-based direct PM participant (BKCCDEFFXXX) sends the SWIFT message (MT 202) using its second BIC.

Case	Receiver	Field entry	Effect
28	Account holder in the PHA BKFFLULUXXX	S: BKCCDEFF425 R: NCBKLULUXXX 52: 56: 57: 58: BKFFLULUXXX	<ul style="list-style-type: none">• Debit entry in the RTGS account in PM of BKCCDEFFXXX• Credit entry in the PM of NCBKLULUXXX

Note: In the proprietary home accounting system the account of the CB will be debited and the account of the account holder in the proprietary home accounting system (BKFFLULUXXX) will be credited.

Originator is indirect PM participant

In the following example the indirect PM participant (BKLLITROXXX) orders its related SWIFT-based direct PM participant (BKBBITRRXXX) to send the SWIFT message (MT 202).

Case	Receiver	Field entry	Effect
29	Account holder in the PHA BKFFLULUXXX	S: BKBBITRRXXX R: NCBKLULUXXX 52: BKLLITROXXX 56: 57: 58: BKFFLULUXXX	<ul style="list-style-type: none">• Debit entry in the RTGS account in PM of BKBBITRRXXX• Credit entry in the PM of NCBKLULUXXX

Note: In the proprietary home accounting system the account of the CB will be debited and the account of the account holder in the proprietary home accounting system (BKFFLULUXXX) will be credited.

- 9.1 SWIFTNet FIN related issues
- 9.1.2 SWIFTNet FIN Messages - Details

Sender proprietary home account holder

In the following examples the proprietary home account holder (BKFFLU-LUXXX) orders its CB to send the SWIFT message (MT 202) (no liquidity transfer - see example no. 34). The field entries describe how the message has to be filled in by the sending CB.

Note: The way the account holder in the proprietary home accounting system has to send the payment instruction to its CB is outside the scope of SSP (also the booking in PHA: debit PHA account holder, credit CB account in PHA). Therefore it is not described in the User Detailed Functional Specifications

9 Technical Specifications

- 9.1 SWIFTNet FIN related issues
- 9.1.2 SWIFTNet FIN Messages - Details

Case	Receiver	Field entry	Effect
30	SWIFT-based direct PM participant BKAAFRPPXXX	S: NCBKLULUXXX R: BKAAFRPPXXX 52: BKFFLULUXXX 56: 57: 58: BKAAFRPPXXX	<ul style="list-style-type: none"> • Debit entry in the RTGS account in PM of the CB • Credit entry in the RTGS account in PM of BKAAFRPPXXX
31	Internet-based direct PM participant BKIIDF1XXX	S: NCBKLULUXXX R: TRGTXEPMLVP 52: BKFFLULUXXX 56: 57: 58: BKIIDF1XXX	<ul style="list-style-type: none"> • Debit entry in the RTGS account in PM of the CB • Credit entry in the RTGS account in PM of BKIIDF1XXX
32	Second BIC of SWIFT-based direct PM participant BKBBITRR321	S: NCBKLULUXXX R: BKBBITRR321 52: BKFFLULUXXX 56: 57: 58: BKBBITRR321	<ul style="list-style-type: none"> • Debit entry in the RTGS account in PM of the CB • Credit entry in the RTGS account in PM of BKBBITRRXXX
33	Indirect PM participant BKDDDEM1XXX related SWIFT-based direct PM participant BKDDDEDDXXX	S: NCBKLULUXXX R: BKDDDEDDXXX 52: BKFFLULUXXX 56: 57: 58: BKDDDEM1XXX	<ul style="list-style-type: none"> • Debit entry in the RTGS account in PM of the CB • Credit entry in the RTGS account in PM of BKDDDEDDXXX

Note: If the receiving party is an Internet-based participant, the BIC of first filled field 56-58 must be a BIC of an Internet-based participant.

In the following example the proprietary home account holder (BKFFLU-LUXXX) orders its CB to send the SWIFT message (MT 202) as liquidity transfer. The field entries describe how the message has to be filled in by the sending CB.

Sender proprietary home account holder (liquidity transfer)

9 Technical Specifications

- 9.1 SWIFTNet FIN related issues
- 9.1.2 SWIFTNet FIN Messages - Details

Note: The way the account holder in the proprietary home accounting system has to send the payment instruction to its CB is outside the scope of SSP (also the booking in PHA: debit PHA account holder, credit CB account in PHA). Therefore it is not described in the User Detailed Functional Specifications.

Case	Receiver	Field entry	Effect
34	Direct PM participant BKFFLULUXXX	S: NCBKLULUXXX R: TRGTXEPMXXX 52: BKFFLULUXXX 56: 57: 58: BKFFLULUXXX	<ul style="list-style-type: none">• Debit entry in the RTGS account in PM of the CB• Credit entry in the RTGS account in PM of BKFFLULUXXX

9 Technical Specifications

- 9.1 SWIFTNet FIN related issues
- 9.1.2 SWIFTNet FIN Messages - Details

9.1.2.4.4 Liquidity transfers with T2S

Sender SWIFT-based direct PM participant

In the following examples the SWIFT-based direct PM participant (BKFFLULUXXX) sends the SWIFT message (MT 202) to push liquidity to a EURO DCA in T2S or to initiate a retransfer to the linked RTGS account.

Case	Receiver	Field entry	Effect
35	DCA holder in T2S BKFFLULUXXX	S: BKFFLULUXXX R: TRGTXPMT2S 52: 58: /LU123456789 BKFFLULUXXX	<ul style="list-style-type: none">• Debit entry in the RTGS account in PM of BKFFLULUXXX• Credit entry in the T2S transit account in PM
36	Other DCA holder in T2S BKCCDEFFXXX	S: BKFFLULUXXX R: TRGTXPMT2S 52: 58: /DE123456789 BKCCDEFFXXX	<ul style="list-style-type: none">• Debit entry in the RTGS account in PM of BKFFLULUXXX• Credit entry in the T2S transit account in PM
37	SWIFT-based direct PM participant BKFFLU-LUXXX	S: BKFFLULUXXX R: TRGTXPMT2S 52: 53: /LU123456789 BKFFLULUXXX 58: BKFFLULUXXX	<ul style="list-style-type: none">• No booking in PM.• Order to transfer liquidity to the RTGS account is forwarded to T2S.• Settlement only takes place after inbound LiquidityCreditTransfer from T2S

9.2 SWIFTNet InterAct and FileAct related issues

9.2.1 Overview

General aspects

Participants have the possibility to connect their back office to the ICM using the application-to-application approach. In addition PM provides interfaces for dedicated business cases. For T2S related business cases the T2S interface and for TIPS related business cases the TIPS interface of PM have to be used. Ancillary systems (AS) have to support the Ancillary System Interface (ASI) if they want to make use of the services especially offered for their settlement purposes. This is possible by using SWIFTNet InterAct and SWIFTNet FileAct exclusively. The back office must be linked via a host adapter with SWIFT's Secure IP Network (SIPN).

The processing of the use cases requires an application, which can “interpret” various XML messages. This application can be developed by the participant, eg AS or CI or can be bought from software providers.

XML structures

Communication via the three TARGET2 interfaces ASI, T2SI and TIPS1 and to the module ICM is based on XML messages.

A detailed description of these XML messages, their elements and data type definitions is available in book 4 of the UDFS. Schema files are available in the Internet as download.

9 Technical Specifications

9.2 SWIFTNet InterAct and FileAct related issues

9.2.1 Overview

Use of SWIFTNet services

In the following table an overview is given for what purposes the XML messages are transferred via SWIFTNet InterAct and/or SWIFTNet FileAct. For detailed information on how to use SWIFTNet services refer to UDFS Book 4 chapter 2.

Purpose	SWIFTNet service	Possible work-flows	Remarks
Requests and responses related to ICM (A2A)	InterAct or (FileAct) (pull)		The request XML message is sent via InterAct (see UDFS book 4, chapter 2.1). Due to the fact that some responses might exceed the maximum volume of InterAct messages (defined by SWIFT at the level of 99,953 Bytes), it is necessary to return the response using FileAct.
TARGET2 directory (full version)	FileAct (pull)		-
TARGET2 directory (delta version)	FileAct (push, store & forward) FileAct (pull)		-
Liquidity transfer (= AS procedure 1): <ul style="list-style-type: none"> • Sending of settlement instructions by AS to ASI • Notifications sent by ASI to AS 	InterAct or FileAct (store & forward) InterAct or FileAct (store & forward)	Request IA/ Notification IA Request FA/ Notification IA NB:	In practice, FileAct will never be used in notifications sent by the ASI to the AS, because the messages related to procedure 1 contain only 1 transaction and therefore are always below the size limit of 99,953 Bytes.

9 Technical Specifications

9.2 SWIFTNet InterAct and FileAct related issues

9.2.1 Overview

Purpose	SWIFTNet service	Possible work-flows	Remarks
		IA = InterAct FA = FileAct	
Real-time settlement (= AS procedure 2): <ul style="list-style-type: none"> • Sending of settlement instructions by AS • Notifications sent by ASI to AS 	InterAct or FileAct (store & forward) InterAct (store & forward)	Request IA/ Notification IA Request FA/ Notification IA	In practice, FileAct will never be used in notifications sent by the ASI to the AS, because the messages related to procedure 2 contain only 1 transaction and therefore are always below the size limit of 99,953 Bytes.
Bilateral settlement (= AS procedure 3): <ul style="list-style-type: none"> • Sending of settlement instructions by AS • Notifications sent by ASI to AS 	InterAct or FileAct (store & forward) InterAct or FileAct (store & forward)	Request IA/ Notification IA Request FA/ Notification IA Request FA/ Notification FA	The size of the notification is always smaller than that of the request.
Standard multilateral settlement (= AS procedure 4): <ul style="list-style-type: none"> • Sending of settlement instructions by AS • Notifications sent by ASI to AS 	InterAct or FileAct (store & forward) InterAct or FileAct (store & forward)	Request IA/ Notification IA Request FA/ Notification IA Request FA/ Notification FA	The size of the notification is always smaller than that of the request.
Standard multilateral settlement (= AS procedure 4): <ul style="list-style-type: none"> • Request for activation/ nonactivation of the guarantee 	InterAct or FileAct (store & forward)		The complete sequence is: <ul style="list-style-type: none"> • Settlement instructions • Notification of failed settlement • Request for (non) activation

9 Technical Specifications

9.2 SWIFTNet InterAct and FileAct related issues

9.2.1 Overview

Purpose	SWIFTNet service	Possible work-flows	Remarks
<p>mechanism (Receipt)</p> <ul style="list-style-type: none"> Notification sent by ASI to AS 	InterAct or FileAct (store & forward)		<ul style="list-style-type: none"> Final notification of settlement <p>It may well be that the request for (non) activation of the guarantee mechanism is in InterAct while the final notification is in FileAct.</p>
<p>Simultaneous multilateral settlement (= AS procedure 5):</p> <ul style="list-style-type: none"> Sending of settlement instructions by AS Notifications sent by ASI to AS 	<p>InterAct or FileAct (store & forward)</p> <p>InterAct or FileAct (store & forward)</p>	<p>Request IA/ Notification IA</p> <p>Request FA/ Notification IA</p> <p>Request FA/ Notification FA</p>	<p>The size of the notification is always smaller than that of the request.</p>
<p>Standard multilateral settlement (= AS procedure 5):</p> <ul style="list-style-type: none"> Request for activation/ nonactivation of the guarantee mechanism (Receipt) Notification sent by ASI to AS 	<p>InterAct or FileAct (store & forward)</p> <p>InterAct or FileAct (store & forward)</p>		<p>The complete sequence is:</p> <ul style="list-style-type: none"> Settlement instructions Notification of failed settlement Request for (non) activation Final notification of settlement <p>It may well be that the request for (non) activation of the guarantee mechanism is in InterAct while the final notification is in FileAct.</p>
Settlement on dedicated liquidityac-		Request IA/ Notification IA	The size of the notification is always smaller than that of

9 Technical Specifications

9.2 SWIFTNet InterAct and FileAct related issues

9.2.1 Overview

Purpose	SWIFTNet service	Possible work-flows	Remarks
counts (= AS procedure 6): <ul style="list-style-type: none"> • Sending of settlement instructions by AS to ASI • Notifications sent by ASI to AS 	InterAct or FileAct (store & forward) InterAct or FileAct (store & forward)	Request FA/ Notification IA Request FA/ Notification FA	the request.
Settlement on dedicated liquidity accounts (= AS procedure 6): <ul style="list-style-type: none"> • Sending of "start of procedure message"/"end of procedure message" from AS to ASI • Sending of "start of cycle message"/"end of cycle message" by AS to ASI 	InterAct or FileAct (store & forward) InterAct or FileAct (store & forward)		
Instructions related to "autocollateralisation" from AS to ASI	InterAct or FileAct (store & forward)		The decision is up to the AS. It has to respect the maximum volume of Inter-Act messages (= 99,953 Bytes) which is defined by SWIFT.
Instructions related to "coupons and redemptions" from AS to ASI	InterAct or FileAct (store & forward)		The decision is up to the AS. It has to respect the maximum volume of Inter-Act messages (= 99,953 Bytes) which is defined by SWIFT.

9 Technical Specifications

9.2 SWIFTNet InterAct and FileAct related issues

9.2.1 Overview

Purpose	SWIFTNet service	Possible work-flows	Remarks
<p>Settlement on dedicated liquidity accounts (= AS procedure 6):</p> <ul style="list-style-type: none">• start of procedure (night time) sent by ASI• ASTransferNotice sent by ASI to the real-time AS after the execution of standing orders• ReturnAccount message sent by ASI to the interfaced AS after the execution of standing orders, the start of cycle and the end of procedure• ReturnAccount message sent by ASI to the real-time AS at the start of cycle• ReturnGeneral-BusinessInformation message sent by ASI to the real-time AS at the start of procedure• ReturnGeneral-BusinessInformation message	InterAct or FileAct (store & forward)		Size dependent

9 Technical Specifications

9.2 SWIFTNet InterAct and FileAct related issues

9.2.1 Overview

Purpose	SWIFTNet service	Possible work-flows	Remarks
<p>sent by ASI to real-time and interfaced AS after the end of cycle</p> <ul style="list-style-type: none"> • Receipt message sent by the ASI to the AS after reception of an erroneous ReturnGeneral-BusinessInformation request-ing Start/End of Procedure/Cycle. 			
<p>LiquidityTransfers with T2S</p> <ul style="list-style-type: none"> • Push liquidity to T2S via LiquidityCreditTransfer message • Pull liquidity from T2S via LiquidityCreditTransfer message • Receive LiquidityCreditTransfer from T2S • Receive BankToCustomerDebitNotification 	<p>InterAct (store & forward)</p>		<p>The PM participant must have opted for value added services of T2S interconnection.</p> <p>The message is pushed to the account owner after settlement on the RTGS account.</p> <p>Optional message sent by T2SI in case of transfer orders from a third party to the account owner if requested in his static data.</p>

9 Technical Specifications

9.2 SWIFTNet InterAct and FileAct related issues

9.2.1 Overview

Purpose	SWIFTNet service	Possible work-flows	Remarks
Cancellation of LiquidityCreditTransfer addressed to T2SI	InterAct (store & forward)		This functionality is only available for third parties using the actor type "T2S Actor in TARGET2" to revoke pending liquidity transfers. Other actors have to use the ICM for this order.
Queries addressed to T2SI and related reports	InterAct (real time) (FileAct – pull mode)		This functionality is only available for third parties using the actor type "T2S Actor in TARGET2". (Eg CSDs and other credit institutions.) Other actors have to use the ICM. Due to the fact that some responses might exceed the maximum volume of InterAct messages (defined by SWIFT at the level of 99,953 Bytes), it is necessary to return the report using FileAct.
LiquidityTransfers with TIPS <ul style="list-style-type: none"> • Push liquidity to TIPS via LiquidityCreditTransfer message • Pull liquidity from TIPS via LiquidityCreditTransfer message • Receive LiquidityCreditTransfer 	InterAct (store & forward)		The message is pushed to the account owner after settlement on the RTGS account. Optional message sent by

- 9.2 SWIFTNet InterAct and FileAct related issues
- 9.2.2 How to use the application-to-application approach

Purpose	SWIFTNet service	Possible work-flows	Remarks
from TIPS <ul style="list-style-type: none">Receive BankToCus-tomerDebitNotifi-cation			TIPSI in case of transfer orders from a third party to the account owner if requested in his static data.

9.2.2 How to use the application-to-application approach

The system requirements, which must be fulfilled to implement an application-to-application solution, vary a lot depending on the solution sought by the individual SSP participant.

Access to the Secure IP Network (SIPN) of SWIFT is required for using SWIFTNet InterAct/SWIFTNet FileAct.

To secure communication and data, SWIFT's Public Key Infrastructure (PKI) is used.

Further details of the various SWIFTNet services and the required infrastructures are available on the www.swift.com homepage or from a regional SWIFT branch.

It is up to the participants to setup these infrastructures with SWIFT or with any other provider of SIPN access software.

The applications developed for the A2A approach must be tested in accordance with the specified extent prior to being used.

9.2.3 Common use cases

The use cases described here are valid for several modules, but no longer for all. System time, tasks and broadcasts cannot be retrieved from T2SI or TIPSI. These requests have to be processed via the ICM server.

System requirements

Tests

9.2 SWIFTNet InterAct and FileAct related issues

9.2.3 Common use cases

9.2.3.1 System time

Aim

A request is used to check the connection to the ICM server (connection test). The returned XML response indicates, that both the user's application and the ICM server work properly and that the SWIFTNet connection is available.

Precondition

- The user is logged in.
- Required role: No RBAC role is required! Every application of a customer that has access to ICM is allowed to execute the connection test.

Postcondition success

The application sending the request will receive the system time.

Postcondition failure

An error message with the relevant error code is issued.

XML request

GetSystemTime

XML response

ReturnSystemTime

9.2.3.2 Get tasks

Aim

A request is used to receive information about all the tasks listed in the task queue. The task queue contains tasks related to all modules (HAM, PM, RM, SF).

The request can be either the search for all tasks with a certain status, or the search for a certain task with a given reference. To retrieve the whole task queue, the request can be executed with no constraints.

Precondition

The user is logged in.

Postcondition success

The application sending the request will receive information on the tasks listed in the task queue.

Postcondition failure

An error message with the relevant error code is issued.

9.2 SWIFTNet InterAct and FileAct related issues

9.2.3 Common use cases

XML request

GetTask

XML response

ReturnTask

9.2.3.3 Get pending data

Aim

A request is used to asynchronously retrieve the result of a previous inquiry that was disrupted by the SSP server because of a timeout event.

“Timeout event“ in this context means that the SSP server detected that the execution time of the request exceeded the allowed time as defined in the SSP parameters. It was disrupted by the SSP server to anticipate the timeout at SWIFT level and to enable the requestor to receive the wanted information later.

Precondition

- The user is logged in.
- A “Receipt“ message was returned to the requestor as a response to a request sent before because of the timeout event. The “Receipt“ message contains a reference number for the later retrieval of the response that could not be delivered in time (timeout event).

Postcondition success

The application sending the request will receive the XML response related to the previous request which was returned because of the timeout event.

Postcondition failure

An error message (within the XML response related to the previously sent XML request is returned) with the relevant error code is issued.

XML request

GetPendingData

XML response

The XML response related to the previously sent XML request is returned as response.

9.2.3.4 Broadcasts

Aim

A request is used to ask for the broadcasts sent during the current business day.

9.2 SWIFTNet InterAct and FileAct related issues

9.2.4 Use cases for Payments Module

Precondition	The user is logged in.
Postcondition success	The application sending the request will receive the broadcasts sent during the current business day.
Postcondition failure	An error message with the relevant error code is issued.
XML request	GetBroadcast
XML response	ReturnBroadcast

9.2.4 Use cases for Payments Module

The required role is not underlined for each use case, since it is always the “application” role for credit institutions (“APPLICATE”).

9.2.4.1 Liquidity management

9.2.4.1.1 Account information on ...

9.2.4.1.1.1 ... account in PM

Aim	A request is used to get information on details of the <ul style="list-style-type: none">• RTGS account of a direct PM participant• sub-account of a direct PM participant
Precondition	<ul style="list-style-type: none">• The user is logged in.• The requestor can be:<ul style="list-style-type: none">– the direct PM participant– the group of accounts manager
Postcondition success	The application sending the request will receive information on the balance on the

9.2 SWIFTNet InterAct and FileAct related issues

9.2.4 Use cases for Payments Module

- RTGS account
- sub-account

An error message with the relevant error code is issued.

Postcondition failure

XML request

GetAccount

XML response

ReturnAccount

9.2.4.1.1.2 ... proprietary home account

Aim

A request is used to get information on details of the proprietary home account (if any) which is linked with the RTGS account in PM.

Note: It is up to the CB which keeps the proprietary home account to support the interface of ICM. If the CB does not do so, a request for information on the proprietary home account will not be successful.

Precondition

- The user is logged in.
- The requestor can be:
 - the direct PM participant
 - the group of accounts manager

Postcondition success

The application sending the request will receive information on the balance on the proprietary home account.

Postcondition failure

An error message with the relevant error code is issued.

XML request

GetAccount

XML response

ReturnAccount

9.2 SWIFTNet InterAct and FileAct related issues

9.2.4 Use cases for Payments Module

9.2.4.1.2 Credit line

Aim

A request is used to receive information on the credit line currently available on the

- RTGS account
- proprietary home account

Note: It is up to each CB to decide whether there is a credit line in place at the level of the RTGS account or at the level of the proprietary home account.

Precondition

- The user is logged in.
- The requestor can be:
 - the direct PM participant
 - the group of accounts manager

Postcondition success

The credit line available at the account defined in the request will be sent to the application of the requestor.

Postcondition failure

An error message with the relevant error code is issued.

XML request

GetCreditLine

XML response

ReturnCreditLine

9.2.4.1.3 Liquidity transfer between ...

9.2.4.1.3.1 ... accounts of the same participant

Aim

A request is used to transfer funds between two accounts belonging to the same participant. In the transfer always the RTGS account is involved; ie the liquidity can be transferred

- from RTGS account to HAM account.

9.2 SWIFTNet InterAct and FileAct related issues

9.2.4 Use cases for Payments Module

- from RTGS account to proprietary home account (if the related CB supports the interface to ICM).
- from proprietary home account to RTGS account (if the related CB supports the interface to ICM).
- from RTGS account to sub-account.
- from sub-account to RTGS account.

The liquidity transfer can be initiated at any time during the operating hours of the system.

Precondition

- The user is logged in.
- The requestor can be:
 - the owner of the RTGS account

Postcondition success

- The amount defined in the request will be immediately transferred between the two accounts indicated in the request.
- The task will be shown in the task queue with a status indicating the successful completion.
- To verify the outcome of the request, the application of the direct PM participant may submit a
 - GetAccount or
 - GetTaskmessage with the appropriate search criteria.

Postcondition failure

- If there is not sufficient liquidity on an account, the liquidity transfer will be rejected. An error message with the relevant error code is issued.
- If an account listed in the request does not belong to the participant an error message with the relevant error code is issued.
- The task will be shown in the task queue with a status indicating the failure.

9 Technical Specifications

9.2 SWIFTNet InterAct and FileAct related issues

9.2.4 Use cases for Payments Module

- In case of a technical error, an error code will be returned to the application of the requestor in the receipt message.

XML request

LiquidityCreditTransfer

XML response

Receipt

9.2.4.1.3.2 ... two accounts of a group of accounts

Aim

A request is used to transfer funds between two accounts belonging to a group of accounts (“virtual account“ or “consolidated information“). In the transfer always two RTGS accounts of direct PM participants belonging to the same group of accounts are involved; ie the liquidity can be transferred from RTGS account to RTGS account only.

The liquidity transfer can be initiated at any time during the operating hours of the system.

Precondition

- The user is logged in.
- The requestor can be:
 - the group of accounts manager

Postcondition success

- The amount defined in the request will be immediately transferred between the two RTGS accounts indicated in the request.
- The task will be shown in the task queue with a status indicating the successful completion.
- To verify the outcome of the request, the application of the group of accounts manager may submit a
 - GetAccount or
 - GetTaskmessage with the appropriate search criteria.

Postcondition failure

- If there is not sufficient liquidity on an account, the liquidity transfer will be rejected. An error message with the relevant error code is issued.

9 Technical Specifications

9.2 SWIFTNet InterAct and FileAct related issues

9.2.4 Use cases for Payments Module

- If the requestor is not the group of accounts manager an error message with the relevant error code is issued.
- If an account listed in the request does not belong to the group of accounts an error message with the relevant error code is issued.
- The task will be shown in the task queue with a status indicating the failure.
- In case of a technical error, an error code will be returned to the application of the requestor in the receipt message.

XML request

LiquidityCreditTransfer

XML response

Receipt

9.2.4.1.4 Standing order liquidity transfer

9.2.4.1.4.1 Get standing order liquidity transfer

Aim

A request is used to receive information about the valid standing order liquidity transfer

- from proprietary home account to RTGS account (if the related CB supports the interface to ICM).
- from RTGS account to sub-account or technical account - procedure 6 real-time.

Precondition

- The user is logged in.
- The requestor can be:
 - the direct PM participant
 - the group of accounts manager (only from RTGS account to sub-account or technical account - procedure 6 real-time)

Postcondition success

The amount of the standing order, which is currently valid, will be sent to the application of the requestor.

9.2 SWIFTNet InterAct and FileAct related issues

9.2.4 Use cases for Payments Module

Postcondition failure

An error message with the relevant error code is issued.

XML request

GetStandingOrderSub (referring to sub accounts)

GetStandingOrderMirror (referring to technical account - procedure 6 real-time)

XML response

ReturnStandingOrderSub (referring to sub accounts)

ReturnStandingOrderMirror (referring to technical account - procedure 6 real-time)

9.2.4.1.4.2 Define standing order liquidity transfer

Aim

A request is used to define a standing order liquidity transfer. The standing order can be defined at any time during the business day. It becomes effective immediately and will be executed

- at a time defined by the proprietary home accounting system (if the CB supports the interface to ICM).
- when a start of procedure message (next business day) is sent by an AS.

Precondition

- The user is logged in.
- The requestor can be:
 - the direct PM participant
 - the group of accounts manager (only from RTGS account to sub-account or technical account - procedure 6 real-time)

Postcondition success

- The amount of the standing order to transfer liquidity between the two accounts defined in the request will be stored. The next time the standing order liquidity transfer is executed, the modified amount will be transferred between the two accounts involved.
- The task will be shown in the task queue with a status indicating the successful completion.

9.2 SWIFTNet InterAct and FileAct related issues

9.2.4 Use cases for Payments Module

Postcondition failure

- To verify the outcome of PHA standing order liquidity transfer, the application of the direct PM participant may submit a:
 - GetAccount or
 - GetTask
- For standing order technical account - procedure 6 real-time or sub-account the outcome of the request is given directly in the receipt. In case of success the status code of the receipt is "0000".
- In the receipt, an error message with the relevant error code is issued.
- For PHA standing order liquidity transfer the task will be shown in the task queue with a status indicating the failure.
- For standing order on technical account - procedure 6 real-time or sub-account, no task will be available. The error code and message is provided directly in the receipt respectively in tags status code and error description.

XML request

ModifyStandingOrder (message is related to Static Data and PHA see UDFS Book 4)

ModifyStandingOrderMirror (referring to technical account - procedure 6 real-time)

XML response

Receipt

9.2.4.1.4.3 Modify standing order liquidity transfer

Aim

A request is used to change a standing order liquidity transfer. The standing order can be modified at any time during the business day. It becomes effective on the next business day and will be executed

- at a time defined by the proprietary home accounting system (if the CB supports the interface to ICM).
- when the first start of procedure message is sent by an AS (sub-accounts or technical account - procedure 6 real-time).

9 Technical Specifications

9.2 SWIFTNet InterAct and FileAct related issues

9.2.4 Use cases for Payments Module

Precondition

- The user is logged in.
- The requestor can be:
 - the direct PM participant
 - the group of accounts manager (only from RTGS account to sub-account or technical account - procedure 6 real-time)

Postcondition success

- The amount of the standing order to transfer liquidity between the two accounts defined in the request will be changed into the amount named in the request.
- The task will be shown in the task queue with a status indicating the successful completion.
- To verify the outcome of the PHA standing order liquidity transfer, the application of the direct PM participant may submit a
 - GetAccount or
 - GetTask
- For standing order technical account - procedure 6 real-time or sub-account the outcome of the request is given directly in the receipt. In case of success the status code of the receipt is "0000".

Postcondition failure

- In the receipt, an error message with the relevant error code is issued.
- For PHA standing order liquidity transfer, the task will be shown in the task queue with a status indicating the failure.
- For standing order on technical account - procedure 6 real-time or sub-account, no task will be available. The error code and message is provided directly in the receipt respectively in tags status code and error description.

XML request

ModifyStandingOrder (message is related to Static Data and PHA see UDFS Book 4)

9 Technical Specifications

9.2 SWIFTNet InterAct and FileAct related issues

9.2.4 Use cases for Payments Module

ModifyStandingOrderMirror (referring to technical account - procedure 6 real-time)

Receipt

9.2.4.1.5 Limit management

9.2.4.1.5.1 Get limit

A request is used to receive information about

- a bilateral limit defined vis-à-vis an other direct PM participant or a virtual group of accounts
 - current bilateral limit
 - standing order bilateral limit
- the multilateral limit defined vis-à-vis all direct PM participants and virtual group of accounts without a bilateral limit
 - current multilateral limit
 - standing order multilateral limit

- Precondition**
- The user is logged in.
 - The requestor can be:
 - the direct PM participant
 - the group of accounts manager

Postcondition success The value of the requested limit will be delivered to the application.

Postcondition failure An error message with the relevant error code is issued.

XML request GetLimit

XML response ReturnLimit

9.2 SWIFTNet InterAct and FileAct related issues

9.2.4 Use cases for Payments Module

9.2.4.1.5.2 Define limit

Aim

A request is used to define the value of a limit

- bilateral
- multilateral

that will become effective the next business day or on the activation date of the related PM account if it is later than the next business day. It is not possible to define a limit for the current business day!

Precondition

- The user is logged in.
- The requestor can be:
 - the direct PM participant
 - the group of accounts manager

Postcondition success

- A bilateral limit or the multilateral limit will be in place effective the next business day.
- The task will be shown in the task queue with a status indicating the successful completion.
- To verify the outcome of the request, the application of the direct PM participant may submit a
 - GetLimit or
 - GetTaskmessage with appropriate search criteria.

Postcondition failure

- An error message with the relevant error code is issued.
- The task will be shown in the task queue with a status indicating the failure.

XML request

ModifyLimit

XML response

Receipt

9.2 SWIFTNet InterAct and FileAct related issues

9.2.4 Use cases for Payments Module

9.2.4.1.5.3 Modify standing order limit

Aim

A request is used to define a new value of a standing order limit

- bilateral
- multilateral

which was already defined before. It will become effective from the next business day on.

Precondition

- The user is logged in.
- The requestor can be:
 - the direct PM participant
 - the group of accounts manager
- A bilateral/multilateral standing order limit must be defined.

Postcondition success

- The amount of an existing bilateral limit or the multilateral standing order limit is modified.

Note: If the amount is changed to "0" it will have the same effect as if the standing order limit is deleted.

- The positive Receipt (status code "0000") is returned. A task with status completed is also created.

Postcondition failure

- In the receipt, an error message with the relevant error code is issued.
- No task is created.

XML request

ModifyLimit (message is related to Static Data see UDFS Book 4)

XML response

Receipt

9.2.4.1.5.4 Modify current limit

Aim

A request is used to define a new value of a limit

- bilateral
- multilateral

valid for the current business day. The adjustment will become effective immediately.

Precondition

- The user is logged in.
- The requestor can be:
 - the direct PM participant
 - the group of accounts manager
- A bilateral/multilateral limit valid for the current business day must already be defined.

Postcondition success

- The amount of an existing current bilateral limit or the current multilateral limit is modified.
Note: If the amount is changed to “0” it will have the same effect as if the current limit is deleted.
- The task will be shown in the task queue with a status indicating the successful completion.
- To verify the outcome of the request, the application of the direct PM participant may submit a
 - GetLimit or
 - GetTaskmessage with appropriate search criteria.

Postcondition failure

- An error message with the relevant error code is issued.
- The task will be shown in the task queue with a status indicating the failure.

9.2 SWIFTNet InterAct and FileAct related issues

9.2.4 Use cases for Payments Module

XML request

ModifyLimit

XML response

Receipt

9.2.4.1.5.5 Delete standing order limits

The deletion of standing order limits is processed as a modification to a zero amount.

XML request

ModifyLimit (message is related to Static Data see UDFS Book 4)

XML response

Receipt

9.2.4.1.5.6 Delete current limit

Aim

A request is used to delete a current limit

- bilateral
- multilateral

which is valid for the current business day. The deletion will become effective immediately but for the current business day only. If the standing order limit is not deleted in parallel the limit will be in place again the next business day, according to the standing order.

Precondition

- The user is logged in.
- The requestor can be:
 - the direct PM participant
 - the group of accounts manager
- A current bilateral limit must be effective.

Postcondition success

- The amount of an existing bilateral or multilateral limit will be changed to “0” for the rest of the current business day.

Note: The same result can be achieved when modifying a current bilateral or multilateral limit and changing the amount into “0”.

9.2 SWIFTNet InterAct and FileAct related issues

9.2.4 Use cases for Payments Module

- The task will be shown in the task queue with a status indicating the successful completion.
- To verify the outcome of the request, the application of the direct PM participant may submit a
 - GetLimit or
 - GetTaskmessage with appropriate search criteria.

Postcondition failure

- An error message with the relevant error code is issued.
- The task will be shown in the task queue with a status indicating the failure.

XML request

DeleteLimit

XML response

Receipt

9.2.4.1.5.7 Modify all / several current bilateral limits

Aim

A request is used to modify all or several current bilateral limits, which is valid for the current business day. The modification will become effective immediately but for the current business day only. If the standing order limit is not modified in parallel, the limit will be in place again the next business day, according to the standing order.

Precondition

- The user is logged in.
- The requestor can be:
 - the direct PM participant
 - the group of accounts manager
- A current bilateral limit must be effective.

Postcondition success

- The amount of an existing bilateral limit will be changed for the rest of the current business day.

9.2 SWIFTNet InterAct and FileAct related issues

9.2.4 Use cases for Payments Module

- Tasks will be shown in the task queue (one per modified limit) with a status indicating the successful completion.
- To verify the outcome of the request, the application of the direct PM participant may submit a
 - GetLimit or
 - GetTask (single request for all tasks or one per task reference)message with appropriate search criteria.
- An error message with the relevant error code is issued.
- The task will be shown in the task queue with a status indicating the failure.

Postcondition failure

XML request

ModifyLimit

XML response

Receipt

9.2.4.1.5.8 Modify all / several standing order limits and define several standing order limits

Aim

A request is used to modify all or several bilateral standing order limits and/or to define several standing order limits which were defined in the past. The modification will become effective the next business day or on the activation date of the related PM account if it is later than the next business day.

Precondition

- The user is logged in.
- The requestor can be:
 - the direct PM participant
 - the group of accounts manager

Postcondition success

- The amount of the requested bilateral or multilateral limit will be changed.
- In case of modification of all/several standing order limits or the definition of several standing order limits the receipt will have one positive (status

9.2 SWIFTNet InterAct and FileAct related issues

9.2.4 Use cases for Payments Module

code "0000") receipt detail for each counterpart for which the modification definition is successful.

- A task with status completed is also created for each positively modified/defined standing order.
- In case of global failure of the modification of all the standing orders liquidity transfer the receipt will have a single negative receipt detail with the indication of the error code.
- In case of failure of modification/definition of several standing order limits the receipt will have a negative receipt detail for each failed modification/definition of limits. For each of these counterpart the receipt details will indicate the error code (in tag status code).
- No task is created for each failed modification.

Note: In case the modification/definition of standing order limits is partially successful the receipt will contain positive and negative receipt details.

Postcondition failure

XML request

ModifyLimit (message is related to Static Data see UDFS Book 4)

XML response

Receipt

9.2.4.1.5.9 Delete all / several current bilateral limit

Aim

A request is used to delete all or several current bilateral limits, which is valid for the current business day. The deletion will become effective immediately but for the current business day only. If the standing order limit is not deleted in parallel, the limit will be in place again the next business day, according to the standing order.

Precondition

- The user is logged in.
- The requestor can be:
 - the direct PM participant
 - the group of accounts manager
- A current bilateral limit must be effective.

9.2 SWIFTNet InterAct and FileAct related issues

9.2.4 Use cases for Payments Module

Postcondition success

- The amount of an existing bilateral limit will be changed to “0” for the rest of the current business day.

Note: The same result can be achieved when modifying one or several current bilateral limit(s) and changing the amount into “0”. Therefore it is possible to delete several current bilateral limits with the ModifyLimit request, while the DeleteLimit request can not be used for this purpose.

- The task will be shown in the task queue with a status indicating the successful completion.
- To verify the outcome of the request, the application of the direct PM participant may submit a
 - GetLimit or
 - GetTaskmessage with appropriate search criteria.

Postcondition failure

- An error message with the relevant error code is issued.
- The task will be shown in the task queue with a status indicating the failure.

XML request

DeleteLimit (for deletion of all bilateral current limits)

ModifyLimit (for deletion of several bilateral limits by modifying them to “0”)

XML response

Receipt

9.2.4.1.5.10 Delete all / several standing order limits

Aim

Deletion of all/several standing order limits is processed as modification of all/several standing order limits to amount 0.

9.2.4.1.6 Reservations

9.2.4.1.6.1 Get reservations

Aim

A request is used to receive information about the

9.2 SWIFTNet InterAct and FileAct related issues

9.2.4 Use cases for Payments Module

- highly urgent reserve
 - current
 - standing order
- urgent reserve
 - current
 - standing order

the direct PM participant or the group of accounts manager of a “virtual group of accounts” has defined.

Precondition

- The user is logged in.
- The requestor can be:
 - the direct PM participant
 - the group of accounts manager

Postcondition success

The value of the requested reservation will be delivered to the application.

Postcondition failure

An error message with the relevant error code is issued.

XML request

GetReservation

XML response

ReturnReservation

9.2.4.1.6.2 Define current reservation

Aim

A request is used to define the value of a current reservation

- highly urgent
- urgent

that will become effective immediately during the business day. It will not be in place any more after changing the business day.

9.2 SWIFTNet InterAct and FileAct related issues

9.2.4 Use cases for Payments Module

Precondition

- The user is logged in.
- The requestor can be:
 - the direct PM participant
 - the group of accounts manager

Postcondition success

- A highly urgent or urgent reservation will be immediately put in place.
- The task will be shown in the task queue with a status indicating the successful completion.
- To verify the outcome of the request, the application of the direct PM participant may submit a
 - GetReservation or
 - GetTaskmessage with appropriate search criteria.

Postcondition failure

- An error message with the relevant error code is issued.
- The task will be shown in the task queue with a status indicating the failure.

XML request

ModifyReservation

XML response

Receipt

9.2.4.1.6.3 Define standing order reservation

Aim

A request is used to define the value of a standing order reservation

- highly urgent
- urgent

that will become effective from the next business day or first activation date of the PM account. It will be in place till it is modified or deleted.

9.2 SWIFTNet InterAct and FileAct related issues

9.2.4 Use cases for Payments Module

Precondition

- The user is logged in.
- The requestor can be:
 - the direct PM participant
 - the group of accounts manager

Postcondition success

- A standing order for highly urgent or urgent reservation will be put in place.
- The task will be shown in the task queue with a status indicating the successful completion.

The outcome of the request is given directly in the Receipt. In case of success the status code of the receipt is "0000".

Postcondition failure

- The error code and message is provided directly in the Receipt respectively in tags status code and error description.
- In case of failure no task is available.

XML request

ModifyReservation (message is related to Static Data see UDFS Book 4)

XML response

Receipt

9.2.4.1.6.4 Modify current reservation

Aim

A request is used to define a new value of the current reservation

- highly urgent
- urgent

valid for the current business day. The adjustment will become effective immediately.

Precondition

- The user is logged in.
- The requestor can be:

9.2 SWIFTNet InterAct and FileAct related issues

9.2.4 Use cases for Payments Module

Postcondition success

- the direct PM participant
- the group of accounts manager
- A highly urgent/urgent reservation valid for the current business day already defined. Otherwise it would be the definition of a current reservation.
- The amount of the existing highly urgent/urgent reservation is modified.
Note: If the amount is changed to “0” there will be no highly urgent/urgent reservation in place any more.
- The task will be shown in the task queue with a status indicating the successful completion.
- To verify the outcome of the request, the application of the direct PM participant may submit a
 - GetReservation or
 - GetTaskmessage with appropriate search criteria.

Postcondition failure

- An error message with the relevant error code is issued.
- The task will be shown in the task queue with a status indicating the failure.

XML request

ModifyReservation

XML response

Receipt

9.2.4.1.6.5 Delete current reservation

Aim

A request is used to delete the current reservation

- highly urgent
- urgent

9.2 SWIFTNet InterAct and FileAct related issues

9.2.4 Use cases for Payments Module

valid for the current business day. The adjustment will become effective immediately.

Precondition

- The user is logged in.
- The requestor can be:
 - the direct PM participant
 - the group of accounts manager
- A highly urgent/urgent reservation valid for the current business day already defined. Otherwise it would be the definition of a current reservation.

Postcondition success

- The amount of the existing highly urgent/urgent reservation is deleted.
- The task will be shown in the task queue with a status indicating the successful completion.
- To verify the outcome of the request, the application of the direct PM participant may submit a
 - GetReservation or
 - GetTaskmessage with appropriate search criteria.

Postcondition failure

- An error message with the relevant error code is issued.
- The task will be shown in the task queue with a status indicating the failure.

XML request

DeleteReservation

XML response

Receipt

9.2.4.1.6.6 Modify standing order reservation

Aim

A request is used to define a new value of the standing order reservation

- highly urgent

9.2 SWIFTNet InterAct and FileAct related issues

9.2.4 Use cases for Payments Module

- urgent

which was already defined before. It will become valid from the next business day on.

Precondition

- The user is logged in.
- The requestor can be:
 - the direct PM participant
 - the group of accounts manager
- A highly urgent/urgent standing order reservation was already defined. Otherwise it would be the definition of a standing order reservation.

Postcondition success

- The amount of the existing highly urgent/urgent standing order reservation is modified.
Note: If the amount is changed to “0” there will be no highly urgent/urgent standing order reservation in place any more.
- The task will be shown in the task queue with a status indicating the successful completion. The outcome of the request is given directly in the Receipt. In case of success the status code of the receipt is “0000”.

Postcondition failure

- The error code and message is provided directly in the Receipt respectively in tags status code and error description.
- In case of failure, no task is available.

XML request

ModifyReservation (message is related to Static Data see UDFS Book 4)

XML response

Receipt

9.2.4.1.7 Levelling out sequence

9.2.4.1.7.1 Get levelling out sequence

Aim

A request is used to receive information about the

- level out sequence to fund debit balances on single accounts.

9.2 SWIFTNet InterAct and FileAct related issues

9.2.4 Use cases for Payments Module

Precondition

The GetSequence message can be sent by the application of the

- group of accounts manager of a “virtual group of accounts“
- the CB acting on behalf of group of accounts manager
- The user is logged in.
- The requestor can be:
 - the group of accounts manager of a “virtual group of accounts“
 - the CB acting on behalf of group of accounts manager

Postcondition success

The value of the requested level out sequence will be delivered to the application.

Postcondition failure

An error message with the relevant error code is issued.

XML request

GetSequence

XML response

ReturnSequence

9.2.4.1.7.2 Define/Modify levelling out sequence

Aim

A request is used to define or modify the value of the levelling out sequence of accounts which will be used to fund the position for levelling out.

The group of accounts manager chooses the sequence of the accounts how they are used to fund debit balances on single accounts.

The ModifySequence message can be sent by the application of a

- group of accounts manager of a “virtual group of accounts“
- CB acting on behalf of a group of accounts manager
- The user is logged in.
- The requestor can be:
 - the group of accounts manager of a “virtual group of accounts“

Precondition

9.2 SWIFTNet InterAct and FileAct related issues

9.2.4 Use cases for Payments Module

Postcondition success

– the CB acting on behalf of group of accounts manager

- The task will be shown in the task queue with a status indicating the successful completion.
- To verify the outcome of the request, the application of the PM participant may submit a
 - GetSequence or
 - GetTaskmessage with appropriate search criteria.

Postcondition failure

- An error message with the relevant error code is issued.
- The task will be shown in the task queue with a status indicating the failure.

XML request

ModifySequence

XML response

Receipt

9.2.4.2 Management of payment queue

9.2.4.2.1 Get payment

Aim

A request is used to receive information about incoming and/or outgoing payments of a direct PM participant. A subset of incoming and/or outgoing payments can be requested by defining the following criteria:

- SWIFT message type
- Amount
- Settlement (debits/credits)
- Priority (highly urgent, urgent, normal)
- Type of payment
- Execution date

9.2 SWIFTNet InterAct and FileAct related issues

9.2.4 Use cases for Payments Module

- Error code
- Status of payment
- Counterpart country
- Counterpart BIC
- Payments with debit time indicator
- Time of finality
- SWIFT fields
- TRN

The data can be delivered as delta-set in relation to a previous request. So the response will contain the changes only.

Precondition

- The user is logged in.
- The requestor can be:
 - the direct PM participant
 - the group of accounts manager

Postcondition success

- Information about payments in the payment queue will be sent to the application of the requestor.
- The response contains the following data:
 - SWIFT message type
 - Amount
 - Settlement (debits/credits)
 - Priority (highly urgent, urgent, normal)
 - Type of payment
 - Execution date
 - Error code (if any)

9.2 SWIFTNet InterAct and FileAct related issues

9.2.4 Use cases for Payments Module

- Status of payment
- Counterpart country
- Counterpart BIC
- Payments with debit time indicator
- Time of finality (if any)
- SWIFT fields
- TRN
- SWIFT message (header, textblock, trailer)

Postcondition failure

An error message with the relevant error code is issued.

XML request

GetTransaction

XML response

- ReturnTransaction or
- ReturnTransactionQueryType “CHNG“, “MODF“, “DELD“ (if delta set retrieval is requested)

9.2.4.2.2 Cancel payment

Aim A request is used to cancel a pending payment.

Precondition

- The user is logged in.
- The requestor can be:
 - the direct PM participant who sent the payment
 - the related group of accounts manager (“virtual account“) the sender belongs to
- The payment to be cancelled must still be pending.
- The payment will be cancelled. It will get a final status “revoked“.
- The task will be shown in the task queue with a status indicating the successful completion.

Postcondition success

9.2 SWIFTNet InterAct and FileAct related issues

9.2.4 Use cases for Payments Module

- To verify the outcome of the request, the application of the direct PM participant may submit a
 - GetTransaction or
 - GetTaskmessage with appropriate search criteria.

Postcondition failure

- An error message with the relevant error code is issued.
- The task will be shown in the task queue with a status indicating the failure.

XML request

CancelTransaction

XML response

Receipt

9.2.4.2.3 Reordering of payments

Aim

A request is used to move a pending payment to the

- top
- bottom

of the payment queue.

Precondition

- The user is logged in.
- The requestor can be:
 - the direct PM participant whose account will be debited if the payment is settled or
 - the related group of accounts manager if the debtor belongs to a “virtual account”
- The payment to be moved must still be pending.

Postcondition success

- The payment will be moved to the
 - top

9.2 SWIFTNet InterAct and FileAct related issues

9.2.4 Use cases for Payments Module

– bottom
of the payment queue.

- The task will be shown in the task queue with a status indicating the successful completion.
- To verify the outcome of the request, the application of the direct PM participant may submit a
 - GetTransaction or
 - GetTaskmessage with appropriate search criteria.
- An error message with the relevant error code is issued.
- The task will be shown in the task queue with a status indicating the failure.

Postcondition failure

XML request

ModifyTransaction

XML response

Receipt

9.2.4.2.4 Change priority

Aim

A request is used to change the priority of a pending payment.

Precondition

- The user is logged in.
- The requestor can be:
 - the direct PM participant who sent the payment or
 - the related group of accounts manager (“virtual account”) the sender belongs to
- The payment of that the priority should be changed, must still be pending.
- The priority of the payment will be changed according to the request.

Postcondition success

9.2 SWIFTNet InterAct and FileAct related issues

9.2.4 Use cases for Payments Module

- The task will be shown in the task queue with a status indicating the successful completion.
- To verify the outcome of the request, the application of the direct PM participant may submit a
 - GetTransaction or
 - GetTaskmessage with appropriate search criteria.

Postcondition failure

- An error message with the relevant error code is issued.
- The task will be shown in the task queue with a status indicating the failure.

XML request

ModifyTransaction

XML response

Receipt

9.2.4.2.5 Change execution time

Aim

A request is used to change the execution time of a payment

- Earliest Debit Time Indicator
- Latest Debit Time Indicator

Precondition

- The user is logged in.
- The requestor can be:
 - the direct PM participant who sent the payment or
 - the related group of accounts manager (“virtual account“) the sender belongs to

Postcondition success

- The execution time will be changed.
- The task will be shown in the task queue with a status indicating the successful completion.

9.2 SWIFTNet InterAct and FileAct related issues

9.2.4 Use cases for Payments Module

- To verify the outcome of the request, the application of the direct PM participant may submit a
 - GetTransaction or
 - GetTaskmessage with appropriate search criteria.

Postcondition failure

- An error message with the relevant error code is issued.
- The task will be shown in the task queue with a status indicating the failure.

XML request

ModifyTransaction

XML response

Receipt

9.2.4.3 Liquidity Redistribution/contingency payments

Aim

A request is used to create liquidity redistribution/contingency payments in case the direct PM participant is temporarily not able to send SWIFTNet FIN messages.

It will be possible to create

- liquidity redistribution payments in favour of
 - other direct PM participants
- contingency payments in favour of
 - CLS
 - EURO1
 - STEP2

Precondition

- The user must be logged in.
- The requestor can be:
 - the direct PM participant

9.2 SWIFTNet InterAct and FileAct related issues

9.2.4 Use cases for Payments Module

Postcondition success

- The function to create liquidity redistribution contingency payments must be released by the national help desk of the related CB.
- The requested liquidity redistribution/contingency payment will be created and settled in PM.
- The task will be shown in the task queue with a status indicating the successful completion.
- To verify the outcome of the request, the application of the group of accounts manager may submit a
 - GetTransaction or
 - GetTaskmessage with the appropriate search criteria.

Postcondition failure

- An error message with the relevant error code is issued.
- The task will be shown in the task queue with a status indicating the failure.

XML request

BackupPayment

XML response

Receipt

9.2.4.4 Business day information

Aim

A request is used to receive information on different types of administrative data linked to PM.

Precondition

- The user is logged in.
- The requestor can be:
 - the direct PM participant

Postcondition success

The application sending the request will receive information on

- daily events, for each event, the scheduled time and the effective event time.

9.2 SWIFTNet InterAct and FileAct related issues

9.2.5 Use cases for Static Data

Postcondition failure

An error message with the relevant error code is issued.

XML request

GetBusinessDayInformation

XML response

ReturnBusinessDayInformation

9.2.5 Use cases for Static Data

The required role is not underlined for each use case, since it is always the “application” role (“APPLICATE” and “APPLIASTE”).

9.2.5.1 Get legal entity

Aim

It is used to get information on legal entity.

Precondition

- The user is logged in and is allowed, thanks to his pre-defined role, to use this transaction.
- Data used by requestor to get information on legal entity may be:
 - Legal entity status (eg active, future, archived/rejected)
 - Legal entity name
 - BIC legal entity
 - CB responsible
 - Modification date

Postcondition success

The information on the requested legal entities is delivered to the application.

Postcondition failure

An error message with the relevant error code is issued.

XML request

GetLegalEntity

XML response

ReturnLegalEntity

9.2 SWIFTNet InterAct and FileAct related issues

9.2.5 Use cases for Static Data

9.2.5.2 Get CB

Aim

It is used to get information on central bank.

Precondition

- The user is logged in and is allowed, thanks to his pre-defined role, to use this transaction.
- Data used by requestor to get information on central bank may be:
 - Central bank status (eg active, future, archived/rejected)
 - Modification date (ie activation date of modification)

Postcondition success

The information on the requested CBs is delivered to the application.

Postcondition failure

An error message with the relevant error code is issued.

XML request

GetCB

XML response

ReturnCB

9.2.5.3 Get participant

Aim

It is used to get information on participant.

Precondition

- The user is logged in and is allowed, thanks to his pre-defined role, to use this transaction.
- Data used by requestor to get information on participant may be:
 - Participant status (eg active, future, archived/rejected)
 - Participant type (eg credit institution, central bank, CB customer, etc.)
 - RTGS participation type (direct, indirect, no participation)
 - HAM participation (has or has not a HAM account)
 - CB responsible
 - Legal entity name

9 Technical Specifications

9.2 SWIFTNet InterAct and FileAct related issues

9.2.5 Use cases for Static Data

- BIC participant
- Participant name
- National sorting code
- Minimum reserve
- SF Allow (flag Y/N)
- Modification date (ie activation date of modification)

Postcondition success

The information on the requested participants is delivered to the application.

Postcondition failure

An error message with the relevant error code is issued.

XML request

GetParticipant

XML response

ReturnParticipant

9.2.5.4 Get T2WildCard

Aim

It is used to get information on TARGET2 wildcard.

Precondition

- The user is logged in and is allowed, thanks to his pre-defined role, to use this transaction.
- The requestor must know precisely the BIC-11 identifying the related participant and the responsible central bank.
- Data used by requestor to get information on TARGET2 wildcard may be:
 - TARGET2 wildcard status (eg active, future, archived/rejected)

Postcondition success

The information on the requested TARGET2 wildcard is delivered to the application.

Postcondition failure

An error message with the relevant error code is issued.

XML request

GetT2WildCard

9.2 SWIFTNet InterAct and FileAct related issues

9.2.5 Use cases for Static Data

XML response

ReturnT2Wildcard

9.2.5.5 Get RTGS account

Aim

It is used to get information on RTGS account.

Precondition

- The user is logged in and is allowed, thanks to his pre-defined role, to use this transaction.
- The requestor must know precisely the BIC-11 identifying the related participant, owner of the RTGS account and the responsible central bank.
- Data used by requestor to get information on RTGS account may be:
 - Account status (eg active, future, archived/rejected)

Postcondition success

The information on the requested RTGS account is delivered to the application.

Postcondition failure

An error message with the relevant error code is issued

XML request

GetRTGSAccount

XML response

ReturnRTGSAccount

9.2.5.6 Get direct debit

Aim

It is used to get information on authorised direct debit.

Precondition

- The user is logged in and is allowed, thanks to his pre-defined role, to use this transaction.
- The requestor must know precisely the BIC-11 identifying the participant, owner of direct debit and the responsible central bank.
- Data used by requestor to get information on direct debit may be:
 - Direct debit status (eg active, future, archived/rejected)

9.2 SWIFTNet InterAct and FileAct related issues

9.2.5 Use cases for Static Data

Postcondition success

The information on the direct debits with the requested status selected of the participant is delivered to the application.

Postcondition failure

An error message with the relevant error code is issued.

XML request

GetDirectDebit

XML response

ReturnDirectDebit

9.2.5.7 Get sub-account

Aim It is used to get information on sub-account.

Precondition

- The user is logged in and is allowed, thanks to his pre-defined role, to use this transaction.
- The requestor must know precisely the BIC-11 identifying the related participant, owner of the sub-account and the responsible central bank.
- Data used by requestor to get information on sub-account may be:
 - Account status (eg active, future, archived/rejected)
 - Modification date (ie activation date of modification)

Postcondition success

The information on the requested sub-accounts is delivered to the application.

Postcondition failure

An error message with the relevant error code is issued.

XML request

GetSubAccount

XML response

ReturnSubAccount

9.2.5.8 Get group of accounts

Aim It is used to get information on group of accounts.

9.2 SWIFTNet InterAct and FileAct related issues

9.2.5 Use cases for Static Data

Precondition

- The user is logged in and is allowed, thanks to his pre-defined role, to use this transaction.
- Data used by requestor to get information on group of accounts may be:
 - Group of accounts status (eg active, future, archived/rejected)
 - Responsible central bank
 - Group of accounts name
 - Group of accounts ID
 - Group of accounts type
 - Modification date (ie activation date of modification)

Postcondition success

The information on the requested group of accounts is delivered to the application.

Postcondition failure

An error message with the relevant error code is issued.

XML request

GetGOA

XML response

ReturnGOA

9.2.5.9 Get contact item

Aim

It is used to get information on contact item.

Precondition

- The user is logged in and is allowed, thanks to his pre-defined role, to use this transaction.
- The requestor must know precisely either the BIC-11 identifying:
 - a legal entity
 - a central bank
 - a participant
 - an ancillary system

9.2 SWIFTNet InterAct and FileAct related issues

9.2.5 Use cases for Static Data

Note: In case of a CB customer as a participant, the country code of the responsible CB must also be filled in.

The information on the contact items of the requested actor (legal entity, CB, participant, AS) is delivered to the application.

An error message with the relevant error code is issued.

GetContactItem

ReturnContactItem

9.2.5.10 Get AS

It is used to get information on ancillary system.

- The user is logged in and is allowed, thanks to his pre-defined role, to use this transaction.
- Data used by requestor to get information on ancillary system may be:
 - Ancillary system status (eg active, future, archived/rejected)
 - Modification date (ie activation date of modification)

The information on the requested ancillary systems is delivered to the application.

An error message with the relevant error code is issued.

GetAS

ReturnAS

9.2.5.11 Get AS settlement bank

It is used to get information on ancillary system settlement bank.

Postcondition success

Postcondition failure

XML request

XML response

Aim

Precondition

Postcondition success

Postcondition failure

XML request

XML response

Aim

9.2 SWIFTNet InterAct and FileAct related issues

9.2.5 Use cases for Static Data

Precondition

- The user is logged in and is allowed, thanks to his pre-defined role, to use this transaction.
- The requestor must know precisely the BIC-11 identifying the ancillary system.
- Data used by requestor to get information on ancillary system settlement bank may be:
 - Status of the link between settlement bank and AS (eg active, future, archived/rejected)
 - Modification date (ie activation date of modification)

Postcondition success

The information on the settlement banks of the selected ancillary system is delivered to the application.

Postcondition failure

An error message with the relevant error code is issued.

XML request

GetASSettBank

XML response

ReturnASSettBank

9.2.5.12 Get TARGET events

Aim

It is used to get information on TARGET events.

Precondition

- The user is logged in and is allowed, thanks to his pre-defined role, to use this transaction.
- Data used by requestor to get information on TARGET events may be:
 - Event status
 - Event responsible
 - Event type
 - Modification date (ie activation date of modification)

9.2 SWIFTNet InterAct and FileAct related issues

9.2.5 Use cases for Static Data

Postcondition success

The information on the requested TARGET event is delivered to the application.

Postcondition failure

An error message with the relevant error code is issued.

XML request

GetEvent

XML response

ReturnEvent

9.2.5.13 Get calendar

Aim

It is used to get information on TARGET2 calendar.

Precondition

- The user is logged in and is allowed, thanks to his pre-defined role, to use this transaction.
- The requestor must ask for a precise year.
- Data used by requestor to get information on TARGET2 calendar may be:
 - Year

Postcondition success

The information on the TARGET2 calendar for the requested year is delivered to the application.

Postcondition failure

An error message with the relevant error code is issued.

XML request

GetCalendar

XML response

ReturnCalendar

9.2.5.14 Get error codes

Aim

It is used to get list of error codes.

9.2 SWIFTNet InterAct and FileAct related issues

9.2.6 Use cases for AS

Precondition

- The user is logged in and is allowed, thanks to his pre-defined role, to use this transaction.

Postcondition success

The information on the requested error codes is delivered to the application.

Postcondition failure

An error message with the relevant error code is issued.

XML request

GetErrorCode

XML response

ReturnErrorCode

9.2.6 Use cases for AS

The required role is not underlined for each use case, since it is always the “application“ role for ASs (“APPLIASTE“).

9.2.6.1 Payment orders sent by AS to ASI

Aim

This XML message is used by the ancillary systems to send transactions to be executed by the SSP. It contains files but it could be used as single where relevant. These payments can also be sent by the CB on behalf on the AS.

Precondition

The ancillary system is logged in and is allowed thanks to his pre-defined role, to use this transaction.

XML request

ASTransferInitiation

- Order sent by AS or CB may be:
 - Liquidity transfer (procedure 1):
 - * order to debit the technical account – procedure 6 – real-time and to credit the settlement bank
 - Real time settlement (procedure 2):

- * order to debit the debtor's settlement bank's account and to credit the creditor's settlement bank's account
- * order to debit the debtor's settlement bank's account and to credit the AS Technical Account
- * order to debit the AS Technical Account and to credit the creditor's settlement bank's account
- Bilateral settlement (procedure 3): File which contains the following different orders:
 - * order to debit the debtor's settlement bank's account and to credit the creditor's settlement bank's account
 - * order to debit the debtor's settlement bank's account and to credit the AS Technical Account
 - * order to debit the AS Technical Account and to credit the creditor's settlement bank's account
- Standard Multilateral settlement (procedure 4): File which contains the following different orders:
 - * order to debit the debtor's settlement bank's account and to credit the AS Technical Account
 - * order to debit the AS Technical Account and to credit the creditor's settlement bank's account
- Simultaneous multilateral settlement (procedure 5): File which contains the following different orders:
 - * order to debit the debtor's settlement bank's account and to credit the AS Technical Account
 - * order to debit the AS Technical Account and to credit the creditor's settlement bank's account
- Dedicated liquidity settlement (procedure 6):
 - * order to increase or decrease the liquidity on behalf of the settlement bank to the technical account – procedure 6 – real-time (real-time model)
 - * order to increase or decrease the liquidity on behalf of the settlement bank to the sub-account (interfaced model)

- * order (connected payment on SSP account) to increase the credit line of a settlement bank then to transfer funds to a sub-account
- * order to debit mandated payments from AS auto-collateral account and to credit sub-accounts
- * order to transfer funds (credit lines from local home account) from CB account to the sub-account
- * order (repo countries) with debit from CB's RTGS account to credit RTGS dedicated sub-accounts
- * order which contains a set of specific credit transfers to increase liquidity by debit of AS Technical Account and credit of main account or sub-account
- * File of orders to settle on dedicated accounts by debiting the sub-accounts towards the AS Technical Account and then debiting the AS Technical Account towards the participants sub-accounts

XML response to the AS

ASInitiationStatus

- Successful process of the request The message provides the following information:
 - Procedure 1: Positive or negative notification (with status reason) on the settlement
 - Procedure 2: Positive or negative notification (with status reason) on the settlement
 - Procedure 3:
 - * List of single positions (debits and credits) and results (settled or not (with status reason))
 - Procedure 4:
 - * Information on the amount of missing liquidity (sent to the AS) to request a decision on the use of the guarantee account.
 - * Positive or negative notification on the entire set of transactions
 - Procedure 5:

- * Information on the amount of missing liquidity (sent to the AS) to request a decision on the use of the guarantee account.
- * Positive or negative notification on the entire set of transactions
- Procedure 6:
 - * Notification of liquidity adjustment on the technical account – procedure 6 – real-time
 - * Notification of liquidity adjustment on the sub-accounts
 - * Notification of increase of liquidity on the sub-accounts in case of connected payment from SSP account
 - * Notification of increase of liquidity on the sub-accounts in case of mandated payments from AS auto-collateral account
 - * Notification of increase of liquidity on the sub-accounts in case of AS order for credit lines from local home account
 - * Notification of increase of liquidity on the sub-accounts in case of AS order for repo countries
 - * Notification of increase of liquidity on sub-accounts by debiting of credit transfers from AS Technical Account (specific transactions)
 - * List of the debit and credit settled or not (with status reason)
- Reject of the request
 - * The message contains the relevant error code for the reject

9.2.6.2 Liquidity adjustment sent by settlement bank via ICM for real-time models

Aim	This XML message is used by the settlement banks in procedure 6 to send current orders to increase the liquidity.
Precondition	The settlement bank is logged in and is allowed thanks to his pre-defined role, to use this transaction.
XML request	SBTransferInitiation

9 Technical Specifications

9.2 SWIFTNet InterAct and FileAct related issues

9.2.6 Use cases for AS

- Order to increase the liquidity in the technical account – procedure 6 – real-time (real-time model)

XML response to SB

Technical Receipt

XML response to AS

ASTransferNotice

- Successful process
The AS receives
 - an ASTransferNotice to be informed of the increase of liquidity on the technical account – procedure 6 – real-time (real-time model) including the information of the resulting balance.

9.2.6.3 Liquidity adjustment sent by settlement bank via ICM for interfaced models

Aim

This XML message is used by the settlement banks in procedure 6 to send current orders to increase or decrease the liquidity on the sub-accounts.

Precondition

The settlement bank is logged in and is allowed thanks to his pre-defined role, to use this transaction.

XML request

LiquidityCreditTransfer

- Order to increase or decrease the liquidity on the sub-accounts (interfaced model)

XML response to SB

Technical Receipt

XML response to AS

ReturnAccount

- Successful process
The AS receives
 - a ReturnAccount to be notified of the increase of liquidity on the amount actually credited on the sub-account (interfaced model).

9.2.6.4 Specific orders sent by CB via ASI

Aim

XML messages are used in procedure 6 by the central bank:

- to send a connected payment on SSP account from CB to increase the liquidity on sub-accounts.
- to increase the liquidity on the settlement sub-account (for repo countries or from proprietary local home account).

XML messages are also used in procedure 6 by the central bank to decrease the dedicated liquidity originated by auto-collateralisation.

Precondition

The central bank is logged in and is allowed thanks to his pre-defined role, to use this transaction.

XML request

ASTransferInitiation

- This order is a connected payment (procedure 6) to: Increase the credit line and then transfer funds from RTGS account to sub-account.
- This order is a connected payment (procedure 6) to: Transfer funds from sub-account to RTGS account and decrease the credit line of the settlement bank.
- Payment from CB to transfer funds from sub-account of settlement bank to auto-collateral account.
- Payment from CB to debit the CB main account (from the proprietary local home account) and increase the liquidity in sub-account.
- Payment from CB to decrease the sub-account and credit the CB main account (to the proprietary local home account).

Answer to the CB

XML response CB

ASInitiationStatus

The message ASInitiationStatus received by the central bank contains the confirmation of the order or the relevant error code for the reject.

9.2 SWIFTNet InterAct and FileAct related issues

9.2.6 Use cases for AS

Successful process

XML response AS

ReturnAccount

The AS receives a ReturnAccount to be notified of the increase or decrease of liquidity on the sub-account.

9.2.6.5 Notice received by Real-time AS from ASI

Aim

This XML message notifies the Real-time AS models with the details of the origin of incoming liquidity on the technical account – procedures 6 – real-time, it is received by the AS in the following cases:

- Procedure 1, in reception of liquidity transfer from settlement bank to AS technical account – procedure 6 – real-time
- Procedure 6, on the execution of standing orders in the SSP at the start of night-time procedure (no daylight procedure with additional standing orders will be available anymore.)
- Procedure 6, on the execution of a current order sent by a settlement bank to increase the liquidity on the technical account – procedure 6 – real-time.

Precondition

- The ancillary system is logged in and is allowed thanks to his pre-defined role, to receive this transaction.
- The settlement module credits the AS technical account – procedure 6 – real-time on a liquidity transfer (MT 202 sent by a SB), a standing order execution (procedure 6) or a current order sent by a settlement bank via ICM by the screen “Liquidity Transfer to Technical account – procedure 6 – real-time” or via A2A with an XML SBTransferInitiation.

XML transfer to the AS

ASTransferNotice

The message ASTransferNotice provides the notification about the incoming liquidity including the information of the resulting balance.

9.2.6.6 Broadcast received by AS or settlement bank via ICM

Aim

This broadcast is received via ICM by the ancillary system or/and by the relevant settlement banks for specific information sent by ASI.

Precondition

The ancillary system/settlement bank is logged in and is allowed thanks to his pre-defined role, to receive this message.

Broadcast

The message is used in the following cases:

- Procedure 1:
 - In case the CB of the AS revokes a payment, a broadcast notification is sent to the AS and to settlement bank to indicate the revoked payment. The broadcast notification contains the references of the revoked transaction.
- Procedure 2:
 - The broadcast message received by a settlement bank contains the reference of the operation posted in the waiting queue for lack of liquidity.
 - Reject for exclusion of a settlement bank is sent to settlement bank and ancillary system.
 - Settlement failure sent to the settlement banks (ex: for exclusion of an AS).
 - In case the CB of the AS revokes an XML transaction, a broadcast notification is sent to the AS and to settlement bank to indicate the revoked payment. The broadcast notification contains the references of the revoked transaction.
- Procedure 3:
 - If the ASTransferInitiation sent by the AS contains the information period parameter then the broadcast message received by the relevant settlement banks gives the possibility to react before the end of the information period.

- The broadcast message received by the relevant settlement banks contains the reference of a withdrawn operation and the code meaning “Transaction revoked for disagreement”.
 - The broadcast message received by the ancillary system contains the reference of a withdrawn operation and the code meaning “Transaction revoked for disagreement”.
 - The broadcast message received by a settlement bank contains the reference of the operation posted in the waiting queue for lack of liquidity.
 - Reject for exclusion of a settlement bank is sent to settlement bank and ancillary system.
 - Reject for AS excluded during information period sent to the settlement banks.
 - In case the CB of the AS revokes XML transactions, a broadcast notification is sent to the AS and to relevant settlement bank to indicate the revoked payment. The broadcast notification contains the references of the revoked transaction.
- Procedure 4:
 - If the ASTransferInitiation sent by the AS contains the information period parameter then the broadcast message received by the relevant settlement banks gives the possibility to react before the end of the information period.
 - The broadcast message received by the relevant settlement banks contains the reference of the withdrawn file and the code meaning “File revoked for disagreement”.
 - The broadcast message received by the ancillary system contains the reference of the withdrawn file and the code meaning “File revoked for disagreement”.
 - The broadcast message received by a settlement bank contains the information on queuing for liquidity.

- The broadcast message sent to all the settlement banks contains the reference of the rejected file and the error code for this settlement failure.
 - Reject for exclusion of a settlement bank is sent to settlement bank and ancillary system.
 - In case the CB of the AS revokes a file, a broadcast notification is sent to the AS and to all settlement banks to indicate the revoked payment. The broadcast notification contains the references of the revoked transaction.
- Procedure 5:
 - If the ASTransferInitiation sent by the AS contains the information period parameter then the broadcast message received by the relevant settlement banks gives the possibility to react before the end of the information period.
 - The broadcast message received by the relevant settlement banks contains the reference of the withdrawn file and the code meaning “File revoked for disagreement“.
 - The broadcast message received by the ancillary system contains the reference of the withdrawn file and the code meaning “File revoked for disagreement“.
 - The broadcast message received by all settlement banks contains the information on queuing for liquidity.
 - The broadcast message sent to all the settlement banks contains the reference of the rejected file and the error code for this settlement failure.
 - Reject for exclusion of a settlement bank is sent to settlement bank and ancillary system.
 - In case the CB of the AS revokes a file, a broadcast notification is sent to the AS and to all settlement banks to indicate the revoked payment. The broadcast notification contains the references of the revoked transaction.

9.2 SWIFTNet InterAct and FileAct related issues

9.2.6 Use cases for AS

- Procedure 6:
 - Reject for exclusion of a settlement bank is sent to settlement bank and ancillary system.

9.2.6.7 Business information received by AS via ASI

Aim

This XML message is received by the ancillary system, via ASI, to indicate the start of procedure for overnight.

Precondition

The ancillary system is logged in and is allowed thanks to his pre-defined role, to receive this message.

XML message

ReturnGeneralBusinessInformation

The message is used in the following cases:

- Procedure 6:
 - The XML message received by the ancillary system contains the notification of start of procedure sent by ASI at the start of a new day (in the evening).

9.2.6.8 Information on dedicated amounts received by AS via ASI

Aim

An XML message is received by the interfaced AS, via ASI, to indicate the amounts credited on sub-accounts and the new balance when the orders are executed.

An XML message is received by the real-time AS, via ASI, to indicate the total amount credited on the technical account – procedure 6 – real time at the start of cycle.

Precondition

The ancillary system is logged in and is allowed thanks to his pre-defined role, to receive this message.

XML message

ReturnAccount

Interfaced AS

9.2 SWIFTNet InterAct and FileAct related issues

9.2.6 Use cases for AS

The message is used in procedure 6 in the following case:

- The XML message received by the ancillary system (interfaced model) contains the amounts actually booked on the sub-accounts after the orders at the start of overnight procedure and at the start of daylight procedure.
- Liquidity adjustments (interfaced models) sent by settlement banks
- Start of cycle
- Connected payments from CB (SSP account or proprietary local home account) on sub-account
- Specific transactions sent by CB to debit technical account and credit main accounts or sub-accounts
- Transactions of auto-collateralisation sent by CB between a technical account – procedure 6 – real time and sub-accounts.
- Back transfer of liquidity on main RTGS accounts at the end of procedure sent by Interfaced AS

Real-time AS

The message is used in procedure 6 in the following case:

- The AS has sent a request of start of cycle. The ASI sends the ReturnAccount XML message to notify the global amount actually blocked on the technical account – procedures 6 – real-time.

9.2.6.9 Business information sent by AS via ASI

Aim

This XML message is used by the ancillary systems in procedure 6 to order the beginning or the end of specific periods (start/end of procedure and start/end of cycle)

Precondition

The ancillary system is logged in and is allowed thanks to his pre-defined role, to use this transaction.

XML request

ReturnGeneralBusinessInformation

9.2 SWIFTNet InterAct and FileAct related issues

9.2.6 Use cases for AS

Orders sent in the message may be:

- Start of cycle (overnight or daylight)
- End of cycle (overnight or daylight)
- Start of procedure (daylight)
- End of procedure (overnight or daylight)

Successful process

ReturnGeneralBusinessInformation

The message provides the following information:

- On response to end of cycle:
 - Status code to notify to the AS the release of liquidity
- On response to end of procedure for interfaced AS:
 - Status code to confirm the end of procedure

XML response to the AS

XML response to the AS

ReturnAccount

Interfaced AS

The message contains the amounts actually booked on the sub-accounts, it is sent after the following orders sent by the AS:

- Start of daylight procedure
- Start of cycle
- End of procedure (Back transfer of liquidity on main RTGS accounts)

Precondition

The message is used in the following case:

- Start of cycle (Global amount actually blocked on the technical account – procedure 6 – real-time)

XML response to the AS

ASTransferNotice

9.2 SWIFTNet InterAct and FileAct related issues

9.2.6 Use cases for AS

The message is used in response to the following order:

- Start of procedure sent by an Real-time AS (an ASTransferNotice sent for each standing order)

Reject of the Request

Receipt

The message provides the following information:

- Status of the reject

9.2.6.10 Orders sent by AS via ICM

Orders in U2A (not XML) are used by the ancillary systems in procedure 6 to send via ICM:

- End of cycle (overnight or daylight)
- End of procedure (overnight or daylight)

ReturnGeneralBusinessInformation

The message provides the following information:

- On response to end of cycle:
 - Status code to notify to the AS the release of liquidity

ReturnAccount

The message provides the following information:

- On response to end of procedure:
 - Notification of the amount of liquidity transferred from sub-accounts of settlement bank to main accounts

XML response to the AS

Aim

XML response to the AS

XML response to the Interfaced AS

9.2 SWIFTNet InterAct and FileAct related issues

9.2.7 Use cases for T2S

9.2.6.11 Orders sent by settlement banks via ICM for connected mechanisms

Aim

An order (not XML) is used by the settlement bank to order the update of the “scheduled time” (“from”) before the inserted “from” time has been reached.

An order (not XML) is sent by the AS to update the “settlement period” via ICM before the inserted “till” has been expired.

9.2.6.12 Receipt sent by AS via ASI

Aim

This XML message is used by the ancillary systems in procedure 4 and procedure 5 to answer, via ASI, with the decision positive or negative on the use of guarantee mechanism.

Precondition

The ancillary system is logged in and is allowed thanks to his pre-defined role, to send this transaction.

XML request

ASInitiationStatus

Information on the amount of missing liquidity (sent to the AS via ASI).

XML response

Receipt

The message sent by the AS via ASI contains a status code to accept or refuse the use of guarantee mechanism for a settlement bank.

9.2.7 Use cases for T2S

9.2.7.1 Liquidity management with T2S DCAs

9.2.7.1.1 Push liquidity to T2S

Aim

A request is used to transfer funds from the RTGS account of a PM participant to a euro DCA held at T2S.

Note: Between initiation of liquidity transfer and its response from TARGET2 there may be a longer period of time because the response is only

created after reception of the T2S Receipt which may be delayed, for example due to T2S maintenance window.

Precondition

- The user is logged in.
- The requestor can be:
 - the direct PM participant - role: "APPLICATE"
 - the group of accounts manager - role: "APPLICATE"
 - the CB of the PM participant - role: "APPLICBTE"
 - T2S Actor in TARGET2, authorized by the account owner to work on his behalf (dn registered with actor type "T2S Actor in TARGET2") - role "APPLICDTE"

Postcondition success

- From a valid and accurate input message a payment (but no task queue entry) is created.
- The amount defined in the request is immediately transferred to the T2S transit account. Exception:
 - In case of instructions initiated by actors registered as "T2S Actor in TARGET2" sent during night-time phases, if the available liquidity is less than the instructed amount but not zero, all available liquidity is transferred to the T2S transit account (partial execution).
- The request (including the amount settled in T2) is forwarded to T2S.
- T2S debits the TARGET2 Transit Account and credits the indicated DCA.
- T2S sends a positive Receipt as confirmation to T2.
- TARGET2 replies to the customer request with a positive Receipt as execution confirmation.

Postcondition failure

- If there are errors in the message no payment and no task queue entry will be created out of it. Message information is only available via screens Select/Display Message; there is no comparable A2A request.
- If there is not sufficient liquidity on an account, the liquidity transfer will be queued when sent during daylight phases until it can be executed based

9.2 SWIFTNet InterAct and FileAct related issues

9.2.7 Use cases for T2S

on new incoming liquidity or is rejected due to end of business day. Instructions sent during night-time phases are immediately rejected in case of no/insufficient available liquidity - with exception of the above mentioned conditions for partial execution.

- If a functional error is detected at T2S level, there will be a reverse booking in PM.
- The requestor is notified with a negative Receipt indicating the failure reason.

XML request

LiquidityCreditTransfer

XML response

Receipt

9.2.7.1.2 Pull liquidity from T2S

Aim

A request is used to get back funds from a linked euro DCA in T2S to the RTGS account of a PM participant.

Note: Between initiation of liquidity transfer and its response from TARGET2 there may be a longer period of time because the response is only created after reception of the T2S Receipt which may be delayed, for example due to T2S maintenance window.

Precondition

- The user is logged in.
- The requestor can be:
 - the direct PM participant - role: "APPLICATE"
 - the CB of the PM participant - role: "APPLICBTE"

Postcondition success

- No payment is created from this request - it is only created after reception of LiquidityCreditTransfer message from T2S (see next chapter).
- The request is forwarded to T2S.
- T2S debits the indicated DCA and credits the TARGET2 transit account.

9.2 SWIFTNet InterAct and FileAct related issues

9.2.7 Use cases for T2S

- After settlement confirmation (Receipt from T2S to TARGET2) the requestor gets positive Receipt from TARGET2 informing that T2S got the request.

Note: This is no booking confirmation for the TARGET2 requestor as amount of a potential partial execution in T2S is not yet known.

- If there are errors in the message no payment and no task queue entry will be created out of it. Message information is only available via screens Select/Display Message; there is no comparable A2A request.
- The requestor receives a negative Receipt indicating the TARGET2 (and T2S) abort reason.

Postcondition failure

XML request

LiquidityCreditTransfer

XML response

Receipt

9.2.7.1.3 Receive liquidity from T2S

Aim

In case of outbound liquidity transfers from T2S, TARGET2 notifies the PM participant about the incoming liquidity with an XML message.

Precondition

- The user is logged in.
- The PM participant opted to receive an XML message and not MT 202 (which is part of value added services).
- A transfer message from T2S was received (initiated via current order [eg “Pull liquidity from T2S“], standing or pre-defined T2S order or automatic retransfer at T2S end of day).

XML message

LiquidityCreditTransfer

9.2.7.1.4 Receive RTGS debit notification

Aim

In case of liquidity transfers from TARGET2 to T2S not initiated by the PM participant himself (the reason could be initiation by a T2S Actor in TARGET2 or initiation via standing order) he is notified about the debit booking with an XML message.

9.2 SWIFTNet InterAct and FileAct related issues

9.2.7 Use cases for T2S

Precondition

- The user is logged in.
- The PM participant opted to receive an XML message and not MT 900 (which is part of value added services).
- Executed liquidity transfer to T2S not initiated by a current order of the PM participant.

XML message

BankToCustomerDebitNotification

9.2.7.2 Request T2S DCA balances via T2

Aim

A request is used to receive information about the current balance of a T2S Dedicated Cash Account.

This value added service is made available for TARGET2 participants who do not want to establish an A2A connection to T2S - eg because T2S requires a business application header.

Precondition

- The user is logged in.
- The requestor can be:
 - the direct PM participant - role: "APPLICATE"
 - the group of accounts manager - role: "APPLICATE"
 - the CB of the PM participant - role: "APPLICBTE"
- The requestor has opted to use the T2S value added services.

Postcondition success

- The query is forwarded to T2S.
- Balance information is received from T2S.
- The requestor receives the balance information in response.
- If the balance report from T2S is delayed the requestor will receive a timeout message with a reference which the requestor can use to get the pending data later.

9.2 SWIFTNet InterAct and FileAct related issues

9.2.7 Use cases for T2S

Postcondition failure

- If either TARGET2 or T2S detects errors in the request, there will be no balance information in the report.
- The requestor receives a report message indicating the TARGET2 (and T2S) abort reason.

XML request

GetAccount

XML response

ReturnAccount

9.2.7.3 Interactions for T2S Actors in TARGET2

Following use cases are valid for T2S Actors in TARGET2 who are authorised by direct PM participants to initiate liquidity transfers to T2S on their account.

9.2.7.3.1 Ask for liquidity transfer status

Aim

A request is used to check the payment status of a liquidity transfer in favour of a T2S DCA in case the requestor misses the Receipt response for the transfer order.

Precondition

- The user is logged in.
- The requestor can be:
 - T2S Actor in TARGET2 having role “APPLICDTE” and authorisation from the PM participant to work with actor type “T2S Actor in TARGET2” for his account.
- The requestor has initiated a liquidity transfer by his own on behalf of the PM participant.

Postcondition success

- The requestor receives a transaction report similar to the one a participant can request from ICM.
- The requestor receives the balance information in response.

9.2 SWIFTNet InterAct and FileAct related issues

9.2.7 Use cases for T2S

Postcondition failure

- If the creation of the transaction report is delayed, the requestor will receive a timeout message with a reference the requestor can use to get the pending data later.
- If TARGET2 detects an error, the requestor will receive a report message indicating the abort reason.

XML request

GetTransaction

XML response

ReturnTransaction

9.2.7.3.2 Revoke a pending liquidity transfer to T2S

Aim

A request is used to revoke a pending liquidity transfer (highest priority) to release blocked liquidity for the settlement of other payments.

Precondition

- The user is logged in.
- The requestor can be:
 - T2S Actor in TARGET2 having role “APPLICDTE” and authorisation from the PM participant to work with actor type “T2S Actor in TARGET2” for his account.
- The requestor has initiated a liquidity transfer to T2S by his own on behalf of the PM participant.
- Settlement of the liquidity transfer is still pending.

Postcondition success

- After PM has executed the revocation, the requestor receives a confirmation.

Postcondition failure

- If TARGET2 detects an error, the requestor will receive a negative reply indicating the TARGET2 abort reason.

XML request

CancelTransaction

XML response

Receipt

9.2.8 Use cases for TIPS

9.2.8.1 Liquidity management with TIPS accounts

9.2.8.1.1 Push liquidity to TIPS

Aim

A request is used to transfer funds from the RTGS account of a PM participant to a euro denominated account held at TIPS.

Note: Between initiation of liquidity transfer and its response from TARGET2 there may be a longer period of time, because the response is created only after PM has received the TIPS Receipt.

Precondition

- The user is logged in.
- The requestor can be:
 - the direct PM participant - role: "APPLICATE"
 - the group of accounts manager - role: "APPLICATE"
 - the CB of the PM participant - role: "APPLICBTE"

Postcondition success

- From a valid and accurate input message a payment (but no task queue entry) is created.
- The amount defined in the request is immediately transferred to the TIPS transit account.
- The request (including the amount settled in T2) is forwarded to TIPS.
- TIPS debits the TARGET2 Transit Account and credits the indicated account.
- TIPS sends a positive Receipt as confirmation to T2.
- TARGET2 replies to the customer request with a positive Receipt as execution confirmation.

9.2 SWIFTNet InterAct and FileAct related issues

9.2.8 Use cases for TIPS

Postcondition failure

- In case of errors in the message no payment and no task queue entry will be created. Message status information is only available via screens Select/Display Message; there is no comparable A2A request.
- Liquidity transfers sent during daylight phases will be queued in case of insufficient liquidity. They will be sent after sufficient liquidity is available. Otherwise it will be rejected at the end of day. Liquidity transfers sent during night-time phases are immediately rejected in case of insufficient liquidity.
- If a functional error is detected at TIPS level, there will be a reverse booking in PM.
- The requestor is notified with a negative Receipt indicating the failure reason.

XML request

LiquidityCreditTransfer

XML response

Receipt

9.2.8.1.2 Pull liquidity from TIPS

Aim

A request is used to get back funds from a linked euro denominated account in TIPS to the RTGS account of a PM participant.

Precondition

- The user is logged in.
- The requestor can be:
 - the direct PM participant - role: "APPLICATE"
 - the CB of the PM participant - role: "APPLICBTE"

Postcondition success

- No payment is created from this request - it is only created after reception of LiquidityCreditTransfer message from TIPS (see next chapter).
- The request is forwarded to TIPS.
- TIPS debits the indicated account and credits the TARGET2 transit account.

9.2 SWIFTNet InterAct and FileAct related issues

9.2.8 Use cases for TIPS

- The request (including the amount settled in TIPS) is forwarded to T2.
- TARGET2 debits the TIPS Transit Account and credits the indicated account.
- After settlement the requestor gets positive Receipt from TARGET2 informing that TIPS got the request.
- In case of errors in the message no payment and no task queue entry will be created. Message status information is only available via screens Select/Display Message; there is no comparable A2A request.
- The requestor receives a negative Receipt indicating the TARGET2 (and TIPS) abort reason.

Postcondition failure

XML request

LiquidityCreditTransfer

XML response

Receipt

9.2.8.1.3 Receive liquidity from TIPS

Aim

In case of outbound liquidity transfers from TIPS, TARGET2 notifies the PM participant about the incoming liquidity with an XML message.

Precondition

- The user is logged in.
- The PM participant opted to receive an XML message.
- A transfer message from TIPS was received

(initiated via current order [eg “Pull liquidity from TIPS“], standing or predefined TIPS order).

XML message

LiquidityCreditTransfer

9.2.8.1.4 Receive RTGS debit notification

Aim

In case of liquidity transfers from TARGET2 to TIPS not initiated by the PM participant himself (eg initiation via standing order) he is notified about the debit booking with an XML message.

9.2 SWIFTNet InterAct and FileAct related issues

9.2.8 Use cases for TIPS

Precondition

- The user is logged in.
- The PM participant opted to receive an XML message.
- Executed liquidity transfer to TIPS not initiated by a current order of the PM participant.

9.2.8.2 Request TIPS account balances via T2

Aim

A request is used to receive information about the current balance of a TIPS account.

Precondition

- The user is logged in.
- The requestor can be:
 - the direct PM participant - role: "APPLICATE"
 - the group of accounts manager - role: "APPLICATE"
 - the CB of the PM participant - role: "APPLICBTE"

Postcondition success

- The query is forwarded to TIPS.
- Balance information is received from TIPS.
- The requestor receives the balance information in response.

Postcondition failure

- If either TARGET2 or TIPS detects errors in the request, there will be no balance information in the report.
- The requestor receives a report message indicating the TARGET2 (and TIPS) abort reason.

XML request

GetAccount

XML response

ReturnAccount

9.3 Internet access related issues

9.3.1 Overview

The Internet access allows the participation in TARGET2 without SWIFT connection. The participants will have access to a dedicated ICM U2A Internet interface for information and control purposes as well as for issuing credit transfers to other TARGET2 participants. As Internet-based participants are not connected to SWIFT, they will receive no messages from TARGET2 (no MT 103(+), MT 202 (COV), MT 204, MT 900/910, MT 940/950, MT 012/019). Therefore Internet-based participants have to monitor all activities on their accounts via ICM during the business day. Nevertheless an account statement will be provided for download at start of day containing the turnover of the previous business day for a period of 10 business days.

9.3.2 Account statement

Internet-based participants will not receive statement files by TARGET2 in push mode. The Internet-based participant will get the account statement containing the booking information of the RTGS account and if applicable sub-accounts of the previous business day in a file, which can be downloaded via the ICM Internet interface at start of day. The statements will be delivered in ASCII code. The statement file is only provided, if the respective flag for account statement generation is set in Static Data. The SWIFT string of the textblock (block 4) of incoming payments from SWIFT-based participants as well as a generated SWIFT string of the textblock (block 4) for incoming payments from other Internet-based participants will be saved in the file (field 86 in the repetitive statement line) and provided to the participants for download and archiving (see structure description for details). The file will be formatted on the basis of the structure of an MT 940 with usage of full SWIFT character set.

The file is divided into repetitive sequences (because statement file generation is based on SWIFT MT 940 generation), all repetitive sequences of one account are stored in one file.

General aspects

Usage

9 Technical Specifications

- 9.3 Internet access related issues
- 9.3.2 Account statement

The download of the statement files will be available for the last 10 business days. After this period the statements will be deleted. It is in the responsibility of the Internet-based participant to download and store the files before deletion.

Filename

The filename of the statements will be formatted as follows:

<Business day date (YYYYMMDD/8!n)>_<Account Identification (34x)>.sta

Examples: 20100120_KESADEF1XXX123456789.sta

Structure

The following table describes the structure of the text block of the account statement file:

Related SWIFT standard			SSP Specifications		
Status	Field	Field name	Status	Format	Use in SSP
---->					
M	20	Transaction Reference Number	M	16x	-
O	21	Related Reference	-	-	Must not be used.
M	25	Account Identification	M	35x	Usage up to 34 digits; account number related to RTGS main account or sub-account debited by an ancillary system.
M	28C	Statement Number/ Sequence Number	M	5n/[5n]	<p>Statement Number: At the beginning of the year and for the first message of a new participant starting with 00001</p> <p>PM: Sequence Number: Starting daily with 00001 In case of overflow of the se-</p>

9 Technical Specifications

9.3 Internet access related issues

9.3.2 Account statement

Related SWIFT standard			SSP Specifications			
Status	Field	Field name	Status	Format	Use in SSP	
					quence number on the same business daythe statement number increases by 1 and the sequence number starts again from 1.	
M	60a	Opening Balance	M	Option F: 1!a6!n3!a15 d Option M: 1!a6!n3!a15d	F = First Opening BalanceD/C Mark, Date, Currency, Amount M = Intermediate Opening BalanceD/C Mark, Date, Currency, Amount	
---->						
O	61	Statement Line	O	6!n[4!n]2a[1!a]15d1!a3!c16x[/16x][34x]		
				Sub-field	For-mat	PM:
				1	6!n	Value date (YYMMDD)
				2	[4!n]	Business daydate (MMDD)
				3	2a	<ul style="list-style-type: none"> • Characters for Debit/Credit (D or C) • Characters for Reversal of Debit/Credit (RD or RC)
				4	[1!a]	Code for money type (not being used)
				5	15d	Amount in Euro
6	1!a3!c	Origination type of turnover (S3!n). 3!n is filled with the respective SWIFT message type (eg S103) " S204 " for all other operations				

9 Technical Specifications

- 9.3 Internet access related issues
- 9.3.2 Account statement

Related SWIFT standard			SSP Specifications		
Status	Field	Field name	Status	Format	Use in SSP
					ordered by a third party (AS, CB or PM)
				7 16x	<p>Ordering party's reference (field 20)</p> <p>Origin of payment is within SSP: (eg liquidityretransfer at EoD to HAM, PHA or other participants; liquiditytransfer from PM to HAM during the day, internal payments from HAM/SF/RM/ECONS I/CRISP to PM)</p> <ul style="list-style-type: none"> • reference (field 20) of the internal message • if field is not available/filled: PM reference <p>AS transactions:</p> <ul style="list-style-type: none"> • "Tag 20" for MT 202 • "Message Identification" for LiquidityCreditTransfer • "SSP internal reference" for U2A, standing orders and operations ordered by PM • "EndToEndIdentification" for all other cases (requested by ASTransferInitiation)
				8 [/16x]	<p>Reference for the institution maintaining the account: SSP internal posting reference for unique identification</p> <p>AS transactions: "SSP internal Reference"</p>
				9 [34x]	<BIC of the sender from the SWIFT

9 Technical Specifications

- 9.3 Internet access related issues
- 9.3.2 Account statement

Related SWIFT standard			SSP Specifications		
Status	Field	Field name	Status	Format	Use in SSP
					<p>Header> /<settlementtime HHMMSS>[/<BIC from field 52>] optional;[/BUP/] optional; only for backup payments [MANPAY/] optional; only for mandated payments Origin of payment is within SSP: <PM BIC> for payments initiated by PM (eg liquidityretransfer at EoD to HAM, PHA or other partici- pants) <BIC customer of ICM request> for payments initiated via ICM (eg liquiditytransfer from PM to HAM and PHA during the day, backup payments) <BIC of field 53 of the internal message> for internal payments from HAM/SF/RMECONS I/CRISP to PMAS transactions: <PM BIC>/HHMMSS for standing orders and for emergencyproce- dure launched automatically by PM (ex: if End of Procedure has not been sent by the AS before the end of day) <AS BIC>/HHMMSS for messages sent by AS <CB BIC>/HHMMSS/<AS BIC> for messages sent by CB on behalf of the AS</p>
					<p>Note: The postings (debit entries and credit entries) are sorted in</p>

9 Technical Specifications

9.3 Internet access related issues

9.3.2 Account statement

Related SWIFT standard			SSP Specifications		
Status	Field	Field name	Status	Format	Use in SSP
					ascending order of the amount.
O	86	Information to Account Owner	O	10240x	Original SWIFT string of textblock (block 4) of incoming SWIFT messages from SWIFT-based participants as well as generated SWIFT string of textblock (block 4) in case of payments from other Internet-based participants

M	62a	Closing Balance (Booked Funds)	M	Option F: 1!a6!n3!a15d Option M: 1!a6!n3!a15d	F = Final Closing Balance D/C Mark, Date, Currency, Amount M = Intermediate Closing Balance D/C Mark, Date, Currency, Amount
O	64	Closing Available Balance (Available Funds)	O	1!a6!n3!a15d	Not used by the SSP.
---->					
O	65	Forward Available Balance	O	1!a6!n3!a15d	Not used by the SSP.

O	86	Information to Account Owner	O	6*65x	Not used by the SSP.

9.4 TARGET2 directory

9.4.1 Purpose

To support the routing of payments in TARGET2, the needed routing information will be provided electronically in a structured TARGET2 directory. Knowing the beneficiary's BIC, name, or national sorting code, the TARGET2 directory delivers the related BIC of the direct participant to be used in the header of a SWIFT message as receiver.

Purpose

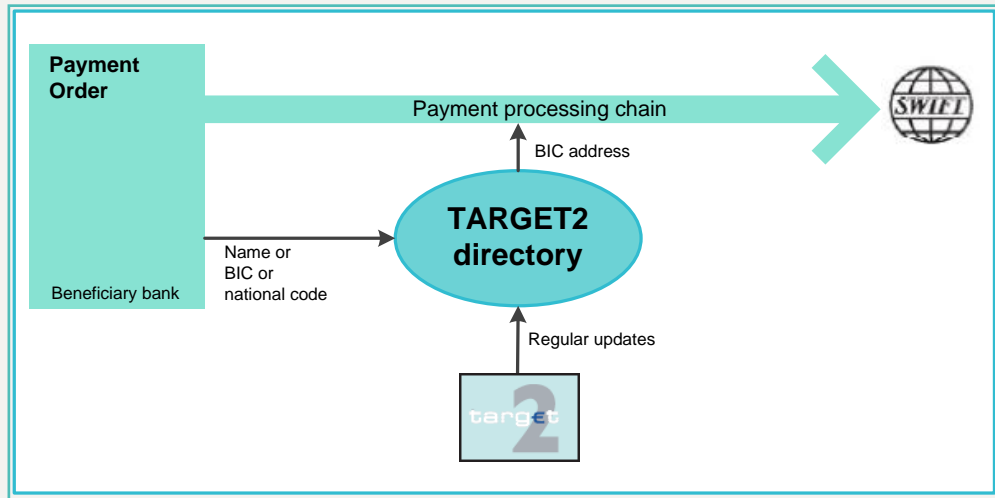

9.4.2 Structure

The following rules apply to the TARGET2 directory:

- PM participants (direct and indirect) with a SWIFT BIC or Non-SWIFT-BIC will be issued (for the access criteria refer to chapter [2.1 Participation in and access to TARGET2, page 15](#)).
- Internet-based direct participants with a published SWIFT BIC or a published Non-SWIFT BIC will be issued.

Basics

- Direct PM participant’s correspondents can be listed in the TARGET2 directory.
- Central bank customer (including Internet-based central bank customer) having an account in the Home Accounting Module of the SSP or in a proprietary home accounting application (PHA) of the central banks can be registered in TARGET2 directory and addressed through the central bank where the preferred HAM or PHA account is kept.
- It is possible for a participant to technically communicate with the SSP from different locations including the use of BICs different from the BIC linked with the RTGS account (but this is more a technical feature, not really a question of indirect participation).
- Every participant’s BIC/Non-SWIFT-BIC is only listed once, while addressee’s and account holder’s ones may occur several times with reference to different participants. However, addressee BIC can, obviously, be related to only one account holder BIC, except for Internet-based participant who share the same SSP platform BIC as addressee BIC.
- The publication of an indirect-direct relation does not prevent to route payments to another direct participant as mentioned in the TARGET2 directory when a different routing is known (ie from Standard Settlement Instructions).

Structure

The structure of the TARGET2 directory is the follows:

O/M	No.	Field name	Format	Note
M	1	BIC	BIC 11	Participant’s BIC
M	2	Addressee	BIC 11	BIC to be used in the header of the SWIFT CUG message
M	3	Account Holder	BIC 11	BIC identifying the settlement bank
M	4	Institution Name	105x	Participant’s companyname Note: The allowed set of characters is the full SWIFT “x” character set and additional

9 Technical Specifications

9.4 TARGET2 directory

9.4.2 Structure

O/M	No.	Field name	Format	Note
				characters: * @ !
O	5	City Heading	35x	Participant's establishment
O	6	National Sorting Code	15x	Participant's national sorting code
O	7	Main BIC Flag	1x	Y: yes N: no Yes means that this BIC could be used to address the payments if the sender has no other information where to send to
M	8	Type of Change	1x	A: added M: modified D: deleted U: unchanged
M	9	Valid from	YYYYMMDD	Date from which the entry is valid
M	10	Valid till	YYYYMMDD	Date up to which the entry is valid(if not specified is equal to "9999-12-31")
M	11	Participation type	2x	01 - "Direct" 02 - "Indirect" 03 - multi addressee - Credit institutions 04 - multi addressee - Branch of Direct participant 05 - addressable BIC – Correspondent (including CB customer), 06 - addressable BIC - Branch of Direct participant 07 - addressable BIC - Branch of Indirect participant 08 - addressable BIC - Branch of correspondent
O	12	Reserve	23x	Space

Meaning of Main BIC Flag

Note: The allowed set of characters is the full SWIFT “x” character set and additional characters: * @ !

Each version of the TARGET2 directory is identified by the name of the file (see chapter [9.4.3 Distribution](#), page 620 for naming convention of the file).

The Main BIC Flag field is intended to help a participant to send a payment to another one when the latter is not precisely known as regards the branch to be quoted. An example may be helpful to clarify the actual case:

Bank B has to send a customer payment to Bank A, which is present in the TARGET2 directory with four occurrences, namely AAAABBCCS40, AAAABBCCS41, AAAABBCCS42 and AAAABBCCS43. Bank B does not know exactly which branch the final beneficiary has an account with. If AAAABBCCS40 has the Main BIC Flag set to Y, while the other three have it filled with N, this means that Bank A, when applying for being inserted in the TARGET2 directory, chose AAAABBCCS40 as BIC where it wanted to receive funds if no more precise information on the right branch to quote were available to the sender. Therefore, when deciding how many and which BICs to list in the directory, it could be worth that a credit institution decided that one of them be flagged as main one, ie a “default” to be used when further information is missing. Equally, when implementing the routing rules within the treasury procedures, participants could use the Main BIC Flag to address those payments for which the credit institution but not the precise branch to be credited is known.

Meaning of the “type of change“ field

In the following table the usage of the “type of change“ field is showed.

Change	Version n-1	Version n	Version n+1
A new record is issued in the version n of the directory (the “valid from“ date has to be higher than the validity date of the version n-1)	not present	A	U
A field (different from the BIC) is changed in the version n	U	M	U
A BIC is no more reachable in TARGET2. The (“valid till“ date +1) has to be strictly less than the validity date of the version n+1).	U	D	not present

It should be noted that if a participant changes the BIC in the version “n“ two rows will be present. The first with the new BIC and “type of change“ equal to “A“ and the second with the old BIC and “Type of change“ equal to “D“.

In some specific situations changes of the valid from field date will be reported with a modification flag set to “U“. The following preconditions have to be fulfilled: First, an internal SSP change takes place which only affects the valid from date of the Current and Future TARGET2 directory.

Second, the internal changes happened before or simultaneously with the first TARGET open day of the validity week of the future TARGET2 directory.

In that situation the change of Valid from date is not significant and there is no need to report a modification.

It should be noted that if a BIC is added in version “n+1“ and modified again with the same activation date: two rows will be present. The first row with the new BIC and “type of change“ equal to “A“ and the second row with the old BIC and “Type of change“ equal to “M“. Only “A“ row has to be taken in-

9.4 TARGET2 directory

9.4.2 Structure

National sorting code

to account, while the “M” row will display a “valid from“ date greater (>) than “valid till“ date.

The national sorting codes are published only for information purpose. The field will be present only if available in the BankDirectoryPlus Database provided by SWIFT each month.

In addition the National sorting codes will be published in TARGET2 directory only for the list of countries established by Eurosystem. Currently only countries which are connected to TARGET2 as well as states / entities which are financially associated to one of these countries, are in the list.

Option for branch publication

A credit institution can ask in the participation form to address the payments not to the BIC-8 but to the BIC-11 of each branch in the receiver field of the Y-copy messages. This option, if selected, applies to all the branches which have a SWIFT BIC.

This is done by using a wildcard rule (see chapter [9.4.4 Administration by central banks, page 623](#)).

As the wildcard rule functionality is not available for Internet-based participants, the branch publication is also not available.

The following examples clarify the use of this option:

Here the wildcard rule would be AAAADEF1789%.

Branch option not selected		
BIC	Address	Account holder
AAAADEFFXXX	AAAADEFFXXX	AAAADEFFXXX
AAAADEFF123	AAAADEFFXXX	AAAADEFFXXX
AAAADEFF456	AAAADEFFXXX	AAAADEFFXXX
AAAADEF1789	AAAADEFFXXX	AAAADEFFXXX

9 Technical Specifications

- 9.4 TARGET2 directory
- 9.4.2 Structure

Branch option selected		
BIC	Address	Account holder
AAAADEFFXXX	AAAADEFFXXX	AAAADEFFXXX
AAAADEFF123	AAAADEFF123	AAAADEFFXXX
AAAADEFF456	AAAADEFF456	AAAADEFFXXX
AAAADEF1789	AAAADEFFXXX	AAAADEFFXXX

The branch flag option is applicable to all the wildcard rules of the credit institution with the participation type multi-addressee - credit institution or multi-addressee - Branch of direct.

The following table provides an example of the details to be found in the TARGET2 directory for the BIC of the main office of a direct participant followed by an example of an MT 103 intended for the latter:

O/M	No.	Field name	Format	
M	1	BIC	BIC 11	AAAACLLXXX
M	2	Addressee	BIC 11	AAAACLLXXX
M	3	Account Holder	BIC 11	AAAACLLXXX
M	4	Institution Name	105x	BANK AAAA
M	5	City Heading	35x	CITY LL
O	6	National Sorting Code	15x	123456789012
O	7	Main BIC Flag	1x	Y
M	8	Type of Change	1x	U

Example for direct participant

9 Technical Specifications

9.4 TARGET2 directory
9.4.2 Structure

O/M	No.	Field name	Format	
M	9	Valid from	YYYYMMDD	20070102
M	10	Valid till	YYYYMMDD	99991231
M	11	Participation type	2x	01

Explanation	Format
Sender	ZZZZCCWWXXX
Message Type	103
Receiver	AAAACCLLXXX
Message text	
Sender's Reference	:20:394442
Bank Operation Code	:23B:CRED
Value Date/Currency/Interbank Settled Amount	:32A:070102EUR121,50
Currency/Instructed Amount	:33B:EUR121,50
Ordering Customer	:50K:3G
Ordering Institution	:52A: ZZZZCCWW Note: For MT 103 Y-copy messages within SSP participants, the field is optional and it has therefore to be filled in only if the BIC of the ordering institution is different from the sender one quoted in block 2 of the header.

9 Technical Specifications

- 9.4 TARGET2 directory
- 9.4.2 Structure

Explanation	Format
Account With Institution	:57A: AAAACCLLXXX Note: For MT 103 Y-copy messages within SSP participants, the field is optional and it has therefore to be filled in only if the BIC of the account with institution is different from the receiving one quoted in block 1 of the header.
Beneficiary Customer	:59:/7244554 PSSC 29, KAISERSTRASSE FRANKFURT AM MAIN
Details of Charges	:71A:SHA

Example for Internet-based direct participant

The following table provides an example of the details to be found in the TARGET2 directory for an Internet-based direct participant followed by an example of an MT 202 intended for the latter:

O/M	No.	Field name	Format	
M	1	BIC	BIC 11	BBBCCLLXXX
M	2	Addressee	BIC 11	TRGTXEPMLVP
M	3	Account Holder	BIC 11	BBBCCLLXXX
M	4	Institution Name	105x	BANK BBBB
M	5	City Heading	35x	CITY LL
O	6	National Sorting Code	15x	123493789012
O	7	Main BIC Flag	1x	N
M	8	Type of Change	1x	U

O/M	No.	Field name	Format	
M	9	Valid from	YYYYMMDD	20101122
M	10	Valid till	YYYYMMDD	99991231
M	11	Participation type	2x	01

Explanation	Format
Sender	AAAACLLXXX
Message Type	202
Receiver	TRGTXEPLVP
Message text	
Sender's Reference	:20:394442
Related Reference	:21:394442
Value Date/Currency/Interbank Settled Amount	:32A:101125EUR121,50
Beneficiary Institution	:58A:BBBCCLLXXX

Example for an addressable BIC - Branch of a direct participant

The following table provides an example of the details to be found in the TARGET2 directory for the BIC of a branch of a direct participant followed by an example of an MT 103 intended for the latter:

O/M	No.	Field name	Format	
M	1	BIC	BIC 11	AAAACLLBBB
M	2	Addressee	BIC 11	AAAACLLXXX
M	3	Account Holder	BIC 11	AAAACLLXXX
M	4	Institution Name	105x	BANK AAAA

9 Technical Specifications

9.4 TARGET2 directory
9.4.2 Structure

O/M	No.	Field name	Format	
M	5	City Heading	35x	CITY LL BBBB
O	6	National Sorting Code	15x	123456222222
O	7	Main BIC Flag	1x	N
M	8	Type of Change	1x	U
M	9	Valid from	YYYYMMDD	20070102
M	10	Valid till	YYYYMMDD	99991231
M	11	Participation type	2x	06

The branch can be located in a country other than the main office's country.

Explanation	Format
Sender	EEEEGGZZXXX
Message Type	103
Receiver	AAACCLLXXX
Message Text	
Sender's Reference	:20:394442
Bank Operation Code	:23B:CRED
Value Date/Currency/Interbank Settled Amount	:32A:070102EUR121,50
Currency/Instructed Amount	:33B:EUR121,50
Ordering Customer	:50K:3G
Ordering Institution	:52A: ZZZZCCWW

Explanation	Format
Account With Institution	:57A: AAAACLLBBB
Beneficiary Customer	:59:/7244554 PSSC 29, KAISERSTRASSE FRANKFURT AM MAIN
Details of Charges	:71A:SHA

Example for a branch of a direct participant quoted also as addressee (multi-addressee)

The following table provides an example of the details to be found in the TARGET2 directory for the BIC of a branch of a direct participant quoted also as addressee followed by an example of an MT 103 intended for the latter. This example is related to the possibility for each credit institution to choose to address the payments not to the BIC-8 but to the BIC-11 of each branch. In this case these choice has to be done for all the branches which have a SWIFT BIC.

O/M	No.	Field name	Format	
M	1	BIC	BIC 11	AAAACLLBBB
M	2	Addressee	BIC 11	AAAACLLBBB
M	3	Account Holder	BIC 11	AAAACLLXXX
M	4	Institution Name	105x	BANK AAAA
M	5	City Heading	35x	CITY LL BBBB
O	6	National Sorting Code	15x	123456222222
O	7	Main BIC Flag	1x	N
M	8	Type of Change	1x	U

9 Technical Specifications

9.4 TARGET2 directory
9.4.2 Structure

O/M	No.	Field name	Format	
M	9	Valid from	YYYYMMDD	20070102
M	10	Valid till	YYYYMMDD	99991231
M	11	Participation type	2x	04

The branch can be located in a country other than the main office's country.

Explanation	Format
Sender	EEEEGGZZXXX
Message Type	103
Receiver	AAAACLLBBB
Message Text	
Sender's Reference	:20:394442
Bank Operation Code	:23B:CRED
Value Date/Currency/Interbank Settled Amount	:32A:070102EUR121,50
Currency/Instructed Amount	:33B:EUR121,50
Ordering Customer	:50K:3G
Ordering Institution	:52A: ZZZZCCWW
Account With Institution	:57A: AAAACLLBBB
Beneficiary Customer	:59:/7244554 PSSC 29, KAISERSTRASSE FRANKFURT AM MAIN
Details of Charges	:71A:SHA

Example for an indirect participant

The following table provides an example of the details to be found in the TARGET2 directory for the BIC of an indirect participant, followed by an example of an MT 202 intended for the indirect participant:

O/M	No.	Field name	Format	
M	1	BIC	BIC 11	BBBBCCL1XXX
M	2	Addressee	BIC 11	AAAACLLXXX
M	3	Account Holder	BIC 11	AAAACLLXXX
M	4	Institution Name	105x	BANK BBBB
M	5	City Heading	35x	CITY LL
O	6	National Sorting Code	15x	1111122222
O	7	Main BIC Flag	1x	Y
M	8	Type of Change	1x	U
M	9	Valid from	YYYYMMDD	20070102
M	10	Valid till	YYYYMMDD	99991231
M	11	Participation type	2x	02

Explanation	Format
Sender	FFFFHHDDXXX
Message Type	202
Receiver	AAAACLLXXX
Message Text	
Sender's Reference	:20:394442

9 Technical Specifications

- 9.4 TARGET2 directory
- 9.4.2 Structure

Explanation	Format
Related Reference	:21: 394442
Value Date/Currency/Interbank Settled Amount	:32A:070102EUR121,50
Beneficiary Institution	:58A: BBBCCCL1XXX

The following table provides an example of the details to be found in the TARGET2 directory for the BIC of a participant whose addressee and account holder BICs are both different from the participant one but all belong to the same legal entity. In this case a CUG registration for BBBCCCLL is needed. An example of an MT 202 intended for the participant's BIC follows:

O/M	No.	Field name	Format	
M	1	BIC	BIC 11	BBBCCCLL237
M	2	Addressee	BIC 11	BBBCCCLLXXX
M	3	Account Holder	BIC 11	BBBCCCRXXX
M	4	Institution Name	105x	BANK BBBB
M	5	City Heading	35x	CITY LL
O	6	National Sorting Code	15x	111111222222
O	7	Main BIC Flag	1x	N
M	8	Type of Change	1x	U
M	9	Valid from	YYYYMMDD	20070102
M	10	Valid till	YYYYMMDD	99991231
M	11	Participation type	2x	04

Example for a participant that communicates with the SSP from a different location (multi-addressee)

9 Technical Specifications

- 9.4 TARGET2 directory
- 9.4.2 Structure

Explanation	Format
Sender	MMMMJJEEXXX
Message Type	202
Receiver	BBBCCLLXXX
Message Text	
Sender's Reference	:20:394456
Related Reference	:21: 394442
Value Date/Currency/Interbank Settled Amount	:32A:070102EUR121,50
Beneficiary Institution	:58A: BBBCCLL237

Example for a CB customer (addressable BIC-correspondent)

The following table provides an example of the details to be found in the TARGET2 directory for the BIC of a CB customer, followed by an example of an MT 202 intended for the CB customer:

O/M	No.	Field name	Format	
M	1	BIC	BIC 11	CBCUCCLLXXX
M	2	Addressee	BIC 11	TRGTXECBCCX
M	3	Account Holder	BIC 11	TRGTXECBCCX
M	4	Institution Name	105x	BANK DDDD
M	5	City Heading	35x	CITY LL
O	6	National Sorting Code	15x	
O	7	Main BIC Flag	1x	Y
M	8	Type of Change	1x	U

9 Technical Specifications

- 9.4 TARGET2 directory
- 9.4.2 Structure

O/M	No.	Field name	Format	
M	9	Valid from	YYYYMMDD	20070102
M	10	Valid till	YYYYMMDD	99991231
M	11	Participation type	2x	05

Explanation	Format
Sender	FFFFHDDXXX
Message Type	202
Receiver	TRGTXECBCCX
Message Text	
Sender's Reference	:20:394442
Related Reference	:21: 394442
Value Date/Currency/Interbank Settled Amount	:32A:070102EUR121,50
Beneficiary Institution	:58A: CBCUCCLLXXX

Weekly update

9.4.3 Distribution

The timely distribution of the directory updates is a crucial issue in order to allow each participant to be able to properly send and receive payments. Taking into account the substantial lack of concrete business cases demanding an immediate update of the directory (except for the exclusion for which see below), a weekly update cycle with a four day step approach has been envisaged as described in the following table:

Business Day	Task
Wednesday	<ul style="list-style-type: none"> • Cut-off date for entries via ICM till 18.00 at the latest • Automatic set-up of new version overnight taking into account also the changes coming from the update of the BIC directory (once a month)
Thursday	<ul style="list-style-type: none"> • Pre-release available to CBs only via ICM • Final changes and validation by CBs till 17.00. These corrections are taken into account in the next TARGET2 directory only if CBs have reported to SSP so that SSP operators can request a regeneration of the TARGET2 directory. • Automatic validation of the final version during End of Day procedure from 18.00 • Overnight broadcast via FileAct to registered members of direct participants (changes only)
Friday	New version available to CBs, CIs and ASs for download (full version)
Monday	Valid date of new version

As described above, the TARGET2 directory computation, validation and distribution process takes 3 business days which normally are Wednesday, Thursday and Friday. If one or two of these days are TARGET holidays, the process will be preponed in the same week. Of course this works only if there are no more than two closed TARGET days (in addition of weekend).

This is normally always the case, but in case this occurs due to exceptional circumstance an ad hoc scheduling will have to be defined.

In principle, BIC changes do not happen suddenly (for exclusion see below), but normally are known several time in advance. Therefore together with the opportunity to use a valid date for each single entry, upcoming changes should be published in the earliest directory update possible. By doing so, much more time is available to correct mistakes in a following update before a change becomes valid for payment processing.

The exclusion of a participant is an extreme remedy to some well identified pathological situations affecting the participant itself which aims at covering any event which “entails systemic risk or could otherwise cause serious operational problems“ (art. 3 (a) 4 of the current TARGET Guideline). Such solution has therefore to be seen as a very exceptional one whose carrying out can consequently be managed on an ad hoc basis without any need to envisage it in a structured framework like a dedicated distribution of the directory update would be. Should a participant have to be removed from the TARGET2 directory the respective central bank will update the static data database immediately via the dedicated ICM functionality and, at the same time, inform the whole community via an ICM broadcast. The directory change will then be inserted in the first update cycle to be managed via the normal channel.

Note: Also in case of the exclusion of an indirect participant this update is taken into account only for the next regular update of the TARGET2 directory.

The SSP provides the TARGET2 directory as an ASCII file containing fields with fixed lengths and no separator via FileAct for SWIFT-based participants. For Internet-based participants, the TARGET2 directory is only available for display via ICM screen.

It must be noted that the not checked (SS=NC) TARGET2 directory files, although they are available for download to all participants, should not be used for other purposes than checking. Only the validated files for the related validity week must be used for routing purposes.

The direct participants in the SSP can receive the files in two ways:

Distribution in case of exclusion of a participant

Delivery

push mode:

Each Thursday after the closing of the operating day the SSP sends to all registered users a file that contains only the changes respect to the previous version of the directory (records with the field “Type of change” equal to “A”, “D”, “M”); the files are sent using the store and forward option foreseen in the FileAct service. This is the preferred way to get an automated TARGET2 directory loading process for routing purpose.

Note: If there are no changes between two versions of the TARGET2 directory, an empty file will be created and distributed.

pull mode:

At any time during the service hours a participant can request to download either a file that contains only the changes with respect to the previous version of the directory or the full content of the latest version available of the directory using the generic functionality of the SWIFTNet FileAct service. The use of the full download is appropriate only for the initial loading of the directory or in case there is a need to rebuild it. Due to the size of the file the use of the compression is strongly recommended.

A new TARGET2 directory version (both “full” and “changes” only) will be available starting from the opening of each Friday business day (Thursday evening calendar day). In pull mode in the standard header fields of the FileAct files the following information, has to be used to retrieve the files:

- Requestor DN: is an X.500 distinguished name ending with:
 - o=<SWIFTNet institution BIC>,o=swift;
- Responder DN:
 - Live environment cn=fileact,ou=prod,o=trgtxepm,o=swift
 - Test environment cn=fileact,ou=tet,o=trgtxepm,o=swift
- Service name:
 - Live environment: trgt.papss
 - Test environment: trgt.papss!p

9.4 TARGET2 directory

9.4.4 Administration by central banks

- Request types:
 - reda.xxx.target2.dirupdate for the directory update
 - reda.xxx.target2.dirfull for the full directory
- File name: T2DIRTTTTZYYYYMMDDSS where:
 - TTTT is the Type:
 - * FULL for the full directory or UPDA for the Update file
- Z for compression
 - Z for Compressed/N for Uncompressed
- YYYYYMMDD: is the year, month and day of the Monday of the week for which the T2DIR is valid

Note: It is always the Monday date even if it is not a TARGET day.
- SS is the status:
 - VA for valid and NC for Not Checked

For example T2DIRUPDAZ20070326VA is the name of the compressed validated TARGET2 directory with only the modifications with validity date March 26, 2007.

The naming convention will also be used for delta version sent in push mode via FileAct (store & forward).

9.4.4 Administration by central banks

Preconditions

BICs and other data are taken from the latest version of SWIFT's BankDirectoryPlus service. Only BICs published by SWIFT can be used in the TARGET2 directory. Participants should take SWIFT's procedure for a new BIC into account when asking for being published.

Forms

Requests for being published in the TARGET2 directory must be addressed in a special form to the User Help Desk at the responsible national central bank. BICs can either be registered single or in order to be able to load a number of BICs having in common the same bank code, by using wildcard rules. For Internet-based participants, only the single registration is possible.

Wildcard rules are defined by wildcard rule lines which are characterised by a wildcard template. A wildcard template is composed of at least a bank code (only format check (4!a) is to be done on the bank code) and a wildcard "*" character which replaces any number of characters. The wildcard character can therefore be at any position from 5 to 11, but must always be at the end of the wildcard template. It is also possible to have no wildcard character in the template. In that case the wildcard rule will apply to only one BIC.

For example the following templates:

BKAAFR*, BKAAFRP*, BKAA*, BKAAFRPP00*, BKAAFRPP001 are valid templates

but BKA*, BKAA*PP001 are not valid templates

Each wildcard rule is either an

Inclusion rule: All public BICs (which do not already identify an RTGS participant) that match the BIC templates entered in the wildcard rule will be automatically loaded in the TARGET2 directory

Exclusion rule: All public BIC that match the BIC templates entered in the inclusion rules but that also match the BIC templates of the exclusion rule are ignored and not loaded in the TARGET2 directory

What is very important to highlight in this respect is that such inclusion/exclusion wildcard approach, will apply also for regular updates of the BIC directory updates. Therefore when a new participant joins the SSP or when a new version of the BIC Directory is published by SWIFT the SSP automatically updates the TARGET2 directory following the above mentioned rules. In any case all the changes have to be validated by the central banks via ICM.

For each wildcard inclusion rule a wildcard participation type must be defined in order to distinguish the different participation situations implemented by wildcard. The different wildcard rule types available for a direct participant are:

- Addressable - Branch

9 Technical Specifications

9.4 TARGET2 directory

9.4.4 Administration by central banks

- Addressable - Correspondent
- Multi-addressee - Branch
- Multi-addressee - Credit institution

For an indirect participant only “addressable - branch” wildcard type is available. For multi-addressee wildcard rule it is possible to specify an addressee BIC different from the direct participant either directly or through the branch flag option.

The wildcard rule type determines the participation type of the loaded BICs in TARGET2 directory.

If Bank A asks to load all its BICs having country code equal to IT, the related form might look like:

BANK CODE	COUNTRY CODE	LOCATION CODE	BRANCH CODE
AAAA	IT	*	

In this case all BICs beginning with AAAAIT will be loaded.

In that example the appropriate wildcard rule type would be 06 - addressable BIC - Branch of direct participant.

A similar solution applies to exclude from the loading a number of BICs having common characteristics. It will be possible, within the example mentioned above, not to load in the participants directory all the BICs having, say, location code equal to GG. There has to be in the form another section related to these exceptions which could look like

BANK CODE	COUNTRY CODE	LOCATION CODE	BRANCH CODE
AAAA	IT	GG	*

Example for loading BICs by using wildcards

Example for exclusion of BICs by using wildcards

- 9.5 Entry check
- 9.5.1 Double entry check for PM

The sequence of these two sections will be interpreted as having to load all BICs starting with AAAAIT with the exception of those starting with AAAITGG.

Notice for example

Taking into account the same example mentioned above, a regular update of BIC directory would imply that all adding, changes and deletion reported in the BIC directory update will be executed for all BICs having AAAAIT as first six positions but not for the ones having AAAITGG as first eight ones.

Special attention has therefore to be paid when explaining the credit institutions such approach and when validating the entries stemming from the forms the latter will send its central bank.

9.5 Entry check

9.5.1 Double entry check for PM

Basics

PM carries out a duplicate submission control for incoming SWIFTNet FIN messages. This control includes fields listed below. Altogether they must be clearly filled in for each business day. Otherwise the payment is rejected because of duplicate submission.

Note: If the message is rejected because of an error within the message, then the next delivery of the “same” (ie corrected) message is not rejected because of the double input validation (to allow the “resending” of the corrected message).

In case of payments (MT103, MT103+, MT202, MT202COV) to an Internet-based participant with the destination address = TRGTXEPLV the BICs in field :56, :57 or :58 from the message text block are used for double entry check instead of the destination address.

Details

In general, the details are gathered from the following fields of the SWIFT message types.

9 Technical Specifications

9.5 Entry check

9.5.1 Double entry check for PM

MT 103/103+/202/202 COV from a SWIFT-based par- ticipant

Details	Part of the SWIFT message	Field
Sender	Basic Header	LT Address
Message Type	Application Header	Message Type
Receiver	Application Header	Destination Address
Transaction Reference Num- ber (TRN)	Text Block	:20
Related Reference	Text Block	:21
Value Date	Text Block	:32
Amount	Text Block	:32

MT 202 from SWIFT based par- ticipants for initi- ation of liquidity transfers with T2S

To prevent rejection of liquidity transfers by T2S, the double entry check on TARGET2 side is very restrictive for these messages. The Related Reference (field 21 of Text Block) has to be unique over a certain period of time (5 days) per impacted RTGS account. This reference is forwarded as EndToEndId to T2S and can be used to identify the origin of booking order.

The reference is compared with those references already used in LiquidityCreditTransfer XML messages forwarded to T2S, related to the same RTGS account. Therefore, if for the same RTGS account LiquidityCreditTransfer XML messages are sent by TARGET2 actors, the included EndToEndId must also not be used in a FIN message. Same is true for references generated by TARGET2 in case of standing orders and current orders entered via ICM.

This means different entities sending orders for the same RTGS account will have to align their referencing. To prevent rejection due to duplicate of a reference generated by TARGET2, the user should avoid using simple numeric references.

9 Technical Specifications

- 9.5 Entry check
- 9.5.1 Double entry check for PM

MT 103/103+/202/202 COV from an Internet-based participant

Details	Part of the SWIFT message	Field
Ordering Institution	Text Block	:52
Message Type	Application Header	Message Type
Receiver	Application Header	Destination Address
Transaction Reference Number (TRN)	Text Block	:20
Related Reference	Text Block	:21
Value Date	Text Block	:32
Amount	Text Block	:32

MT 204 from a SWIFT-based participant

In the MT 204 only sequence A is used for the processing in the SSP. So for the double entry check of an MT 204 the following fields are used.

Details	Part of the SWIFT message	Field
Sender	Basic Header	LT Address
Message Type	Application Header	Message Type
Receiver	Application Header	Destination Address
Transaction Reference Number (TRN)	Text Block (Sequence A)	:20
Related Reference [*]		
Value Date	Text Block (Sequence A)	:30
Amount	Text Block (Sequence A)	:19 (sum of amounts)

Remark

XML messages
e.g. camt.050 Li-
quidityCredit-
Transfer

* Not included in the check, because there is no field 21 in sequence A.

Three layers of double entry check are performed.

Fields	Error code
The messageID in camt.050 must be unique over 5 business days per RequesterDN	T40 Double Message Identification.
TRN has to be unique per BIC on a given Business day for those camt.050	T41 Double Instruction Identification
EndToEndID must be unique per RTGS account. It is compared with IDs used in LiquidityCreditTransfer messages (related to the same RTGS account) forwarded to T2S over the last 5 business days. Payments/messages rejected before forwarding to T2S are not taken into account	T42 Double End-to-End Identification

9.5.2 Error codes

Error codes

In the following table the error codes related to PM (Y-copy), HAM (V-shape) and XML messages are listed. Apart from the listed errors the occurrence of SWIFT (application) errors is possible but these error codes are not part of the list.

Note: The column “SSP code” is for internal use only.

SSP Code	Y-copy	V-shape	XML	Description
SSP communication				
800	A0	XI50		MAC-error input
801	A1	XI59	2859	Request Timed Out

9 Technical Specifications

9.5 Entry check
9.5.2 Error codes

SSP Code	Y-copy	V-shape	XML	Description
T98			T098	Liquidity Transfer unsettled in T2S but negative Receipt from T2S is missing - reasons under investigation.
Modules input validation				
850	B0	XI00	2850	Generic error
851	B1	XI11	2851	Message format error
852	B2	XI12	2852	Invalid character or invalid numeric value
853	B3	XI13	2853	Unexpected data
854	B4	XI14	2854	Invalid decimal value
855	B5	XI15	2855	Too many fields
856	B6	XI16	2856	Field too short
857	B7	XI17	2857	Field too long
858	B8	XI00	2858	Mandatory field not found
861	C1	RF01	2861	Double input
862	C2	TM01	2862	Request out of cut-off time
863	C3		N.A.	Direct debit not accepted from receiver.
864	C4			Payments to CBs' ECB account are not allowed.
865		XI02	2865	Missing receiving legitimacy
866	C6	AC06	2866	Exclusion of participant
867	C7	XI00	2867	BIC debtor and creditor must be different
868	C8	XI19	2868	Invalid sending/receiving BIC
870	D0			Field 72 using of codeword /CONPAY/ is only allowed if a CB is sender of the message.

9 Technical Specifications

9.5 Entry check
9.5.2 Error codes

SSP Code	Y-copy	V-shape	XML	Description
871	D1	DT01	2871	Backup payment is not allowed/Value date in past not allowed.
872	D2	DT01	2872	Field 32A/30 - TARGET2 non working day or value date too far in the future
873	D3	XT03	2873	Field 32A/32B - Currency is not EUR
874	D4	XI11	2874	Field 56a - Invalid field option
875	D5	XI11	2875	Field 57a - Invalid field option or missing account number
876	D6	XI18	2876	Invalid using codeword TILTIME, FROTIME, CLSTIME, REJTIME
877	D7	XI11	2877	Field 52a - Invalid field option
878	D8		2878	Latest debittime (option A) is reached.
879	D9		2879	Field 58 is not filled with HAM participant.
880	E0			Field 53/58 must be filled with a BIC of a direct participant belonging to the sending CB if code-word /CONPAY/ is used.
881	E1			Sequence B is only allowed once in case of MT 204 as connected payment or addressed to an Internet-based participant.
882	E2			Field 72 - amount following codeword /CONPAY/ is missing or has wrong format.
884	E4		2884	For definition or change of a credit line (also in case of connected payments) the related account must have the participant type "CI" and the account type "normal".
885	E5			Field 58 accountline for payments addressed to TRGTXEPMXXX no sub-account allowed.

9 Technical Specifications

9.5 Entry check

9.5.2 Error codes

SSP Code	Y-copy	V-shape	XML	Description
886	E6			Liquidity transfers to sub-accounts, technical account - procedure 6 real-time or T2S must be highly urgent.
887	E7			Wrong format or value of UTC shift
888	E8			Daylight procedure is closed.
890	K0	XI24	2890	Field not allowed because debtor or receiver of the payment is in module HAM.
891	K1	XT20	2891	Field 72 - using of codeword /MANPAY/ is only allowed if a CB is sender of the message.
892	K2		2892	Field 52 must be filled with a BIC of a direct participant if codeword /MANPAY/ is used.
893	K3		2893	Priority highly urgent not allowed for this kind of payment.
894	K4		2894	Function is not allowed in the current business day phase.
896	K6			Payments to ECB mirror accounts are not allowed.
897	K7		2897	Message is unexpected unless TIPS connection is activated.
910			S100	No data available for selected criteria.
911			S110	Access to selected data is not authorized.
950			S500	Inconsistent data input
960			S600	The requested creation is not possible.
970			S700	The requested deletion is not possible.
980			S800	The requested update is not possible.

9 Technical Specifications

9.5 Entry check
9.5.2 Error codes

SSP Code	Y-copy	V-shape	XML	Description
998			S998	Technical SDM failure
999			S999	General SDM failure
P11			P011	A multilateral limit can only be defined or is valid if at minimum one bilateral limit towards another direct participant is defined.
AS specific				
A01			A001	Sender not allowed.
A02			A002	AS missing or not allowed in InitiatingParty/SubjectDetails.
A03			A003	Invalid date
A04			A004	Invalid ControlSum
A05			A005	Invalid NumberOfTransactions
A06			A006	Invalid PriorityType
A07			A007	Invalid SettlementModelType
A08			A008	SettlementModelType not allowed for the sender.
A09			A009	Invalid InformationPeriodType
A10			A010	Invalid FromTime
A11			A011	Invalid ToTime
A13			A013	Invalid PaymentScheme code
A14			A014	FirstAgent not allowed.
A15			A015	FirstAgent domestic account not allowed.
A16			A016	FinalAgent not allowed.

9 Technical Specifications

9.5 Entry check

9.5.2 Error codes

SSP Code	Y-copy	V-shape	XML	Description
A17			A017	FinalAgent domestic account not allowed.
A18			A018	FirstAgent and FinalAgent accounts must be different.
A19			A019	Double GroupIdentification
A20			A020	Double payment identification
A21			A021	Value date in the past or too far in the future
A22			A022	Currency is not EUR.
A23			A023	Sum of debit from technical account is not equal to sum of credit to technical account.
A24			A024	Amount unavailable
A25			A025	DebitAccountOwner not allowed.
A26			A026	CreditAccountOwner not allowed.
A27			A027	Debit DomesticAccount not allowed.
A28			A028	Credit DomesticAccount not allowed.
A29			A029	The qualifier must be formatted.
A30			A030	Code unknown.
A31			A031	Reference unknown.
A32			A032	Invalid StatusCode
A33			A033	Inconsistency between SettlementModelType, FirstAgent and FinalAgent
A34			A034	Order or message out of sequence
A35			A035	Procedure already open.

9 Technical Specifications

9.5 Entry check
9.5.2 Error codes

SSP Code	Y-copy	V-shape	XML	Description
P36			P236	Procedure already closed.
A37			A037	Cycle already open.
A38			A038	Cycle already closed.
A39			A039	AS excluded.
A40			A040	The AS is not authorised to request a connected payment.
A41			A041	Debtor BIC is not a published SWIFT BIC.
A42			A042	Creditor BIC is not a published SWIFT BIC.
A43			A043	Number of transactions too high.
A49			A049	It is not possible to revoke one single transaction in model 4 and 5.
A50			A050	Revoke is only usable for files referring to settlement procedure 4 and 5.
A51			A051	Revoke is only possible if status of file is "information period".
A52			A052	File not found.
A53			A053	Change settlement period is possible only if settlement period is defined.
A54			A054	Requested time for end of settlement period is not possible before end of information period.
A55			A055	Requested time for end of settlement period is not possible in the past.
A56			A056	Related AS does not participate in settlement model 6 real-time.

9 Technical Specifications

9.5 Entry check
9.5.2 Error codes

SSP Code	Y-copy	V-shape	XML	Description
A57			A057	FinalAgent must be a technical account – procedure 6 – real-time.
A58			A058	Settlement bank is not allowed to address this technical account – procedure 6 – real-time.
A60	A6			Message type not supported.
A70			A070	Counterpart AS does not contain a valid AS BIC in relation with the sender.
A71			A071	Counterpart AS forbidden for transactions other than cross-AS settlement.
A72			A072	Debtor BIC is not a settlement bank linked to the real-time AS sender of cross-AS settlement.
A73			A073	Creditor BIC is not a settlement bank linked to the real-time AS receiver of cross-AS settlement.
A80			DPNS	Daylight settlement period has not started.
A81			GALL	Lack of liquidity on the guarantee account
A82			GANR	AS decision to use the guarantee account was negative.
A83			GENE	Generic error
A84			RJED	Payment reject at end of day
A85			RJSP	The payment is rejected because the settlement period time is reached.
A86			RVOK	The payment has been revoked.
A87			REVR	Rejection after reversing procedure
A88			RJCT	Payment initiation or individual transaction included in the payment initiation has been rejected.

9 Technical Specifications

9.5 Entry check
9.5.2 Error codes

SSP Code	Y-copy	V-shape	XML	Description
A89			INVL	Invalid file or transaction
A90			COPS	Current order partially settled
A91			ACSC	Accepted, settlement completed
A92			EXAS	The file/transaction is rejected because the AS is excluded.
A93			RJDA	File/transaction was revoked by the CB after disagreement.
P42			P212	Reference limited to 16 alphanumerical characters
P44			P214	FirstAgent not allowed.
P46			P216	FinalAgent not allowed.
HAM/SF/RM/ECONS I specific				
H01		XI01	H001	Sender not allowed
H02		XI04	H002	Debit account not open
H03		XI07	H003	Sender not allowed to debit the specified account
H04	M4	XT16	H004	Operation not allowed (eg cross border)
H05		XI09	H005	Returned (cancelled) at end of the day
H06			H006	No data available (eg an empty list)
H07	M7		H007	Account not open
H08			H008	Requestor unknown
H09			H009	Parameter logical error <.>
H10	M1		H010	Data not found (request data doesn't exist)

9 Technical Specifications

9.5 Entry check

9.5.2 Error codes

SSP Code	Y-copy	V-shape	XML	Description
H11			H011	Requested BIC unknown
H12			H012	Requested BIC missing in input
H13			H013	Requested field missing in input
H14			H014	Requested countrycode missing in input
SSP queuing				
600	L0	XI08		Revocation of payment
601			PORV	Pending order revoked
610	L1	AM04	RDIB	Removal of payment because of missing cover or exceeding a limit/order rejected due to insufficient balance
620	L2		EXSB	Exclusion of payment by PM/Exclusion Settlement Bank
630	L3			Rejection of user order because payment not queued anymore
640	L4		NNCL	Decrease must not lead to a negative credit line
650	-			Pending order replaced by new order
651	L5			CB closed or end-of-day-procedure in progress
XML common status codes				
X01	-	-	1001	Execution timeout limit exceeded.
X02	-	-	1002	Data not yet available.
X03	-	-	1003	Message size limit exceeded.
X04	-	-	1004	File size limit exceeded (Sw:RejectDescription)
X05			1005	Data not available.

9 Technical Specifications

9.5 Entry check

9.5.2 Error codes

SSP Code	Y-copy	V-shape	XML	Description
X07	-	-	1101	An application header must be send with each message.
X08	-	-	1102	The payload must not be empty.
X09			1103	Processing not possible. Check addressed module and message.
X11	-	-	1199	Free text (parser output)
X22	-	-	9999	General system error
X40			1400	BIC must indicate a SSP participant
X43	-	-	1403	No permission. At least one RBAC role is reserved in A2A mode only but used in U2A.
X46	-	-	1416	No access. There is more than one BIC assigned to the DN.
X49	-	-	1409	No permission. At least one RBAC role is reserved in U2A mode only but used in A2A.
X57			1417	Requestor DN not found in the DN matching table.
X59			1419	No authorisation. Requestor may not initiate this order type.
X60			1420	“Work as“ selection mandatory if DN is linked to several participants.
X62	TL		1422	The DCA must be linked to a RTGS account related to the sender.
X65				You are not allowed to see further information
X70			1430	This request type has to be sent in real-time mode.

9 Technical Specifications

9.5 Entry check
9.5.2 Error codes

SSP Code	Y-copy	V-shape	XML	Description
X71			1431	This request type has to be sent in store-and-forward mode.
XML operating status codes				
X00	-	-	0000	O.k.
X34	-	-	1304	No task-queue information found.
X35	-	-	1035	The query name is not related to a previous query.
XML security status codes				
X10	-	-	1110	Missing mandatory signature or signature invalid.
X41	-	-	1401	No permission. RBAC user role(s) are not sufficient.
X42	-	-	1402	No authorisation. User is not allowed acting on behalf of another participant.
X44	-	-	1404	If "non repudiation of emission" is mandatory, the NRE indication flag has to be present.
X45	-	-	1405	No authorisation or rather interaction not possible. User is not allowed acting on behalf of another participant as group of accounts manager.
X47	-	-	1407	No authorisation. User is not allowed acting on behalf of another participant as central bank.
X48	-	-	1408	Interaction only possible for the virtual account manager.
X50	-	-	1413	No authorisation. User is not allowed acting on behalf of another participant as collateral management system.
X51	-	-	1411	The selected participant is no group of accounts

9 Technical Specifications

9.5 Entry check
9.5.2 Error codes

SSP Code	Y-copy	V-shape	XML	Description
				manager.
X52	-	-	1410	Debit and credit account don't belong to the same group of accounts.
X53	-	-	1412	Credit account does not belong to the debtor.
X54	-	-	1414	No authorisation. No access to another participants sub-account as collateral management system.
X55			1415	A combination of different A2A roles is not allowed.
X58			1406	No authorisation. User is not allowed acting on behalf of another participant as T2S Actor in TARGET2.
X61			1421	Requestor DN not linked to the indicated working BIC.
X61	TL		1422	The DCA must be linked to an RTGS account related to the sender.
X63			1423	No authorisation. Requester is no PM participant.
X64			1424	No authorisation. Requester has insufficient actor type.
Functional status codes (PM, T2SI, PHA, ICM)				
700			2700	Repeat Sending only possible for MT 103, 202, 900 or 910
701			2701	Repeat Sending not possible at this status of the message
702				Start of algorithm already manually initiated
703			2708	Negative amounts are not allowed

9 Technical Specifications

9.5 Entry check

9.5.2 Error codes

SSP Code	Y-copy	V-shape	XML	Description
704				You are not allowed to change the defined chronological order of the events. Please use another time.
705			2705	The address for liquidity removal is missing
706				The selected algorithm is currently deactivated in the algorithm parameters. The algorithm must be activated before the manual start.
869			2869	Backup to TARGET1 is no longer supported.
895	K5		2895	Message is unexpected unless T2S connection is activated.
P04			P004	If you want to select SWIFT fields in your preferences, you must select your own accounts.
P05			P005	You are not allowed to select the Internal Interlinking Reference.
P06			P006	If you want to select SWIFT fields, you must select your own accounts.
P07			P007	If you want to search for PaymentInstructionStatusDateTime, you have to send one request per payment status.
P08			P008	You are not allowed to select the element Receiver Information.
P09			P009	You are not allowed to select this broadcast status.
P10			P010	The multiplicity of the element "Instr" and "PrcgVldtyTm" is unequal.
P12			P012	Modification, setting or deletion of limits not possible.

9 Technical Specifications

9.5 Entry check
9.5.2 Error codes

SSP Code	Y-copy	V-shape	XML	Description
P13			P013	No payment found.
P14			P014	No Limit found.
P15			P015	No bilateral limit defined for Counter Party.
P16			P016	No current Reservation found.
P18			P018	No Business DayData found.
P20			P020	If you want to select SWIFT fields, select accounts you are responsible for.
P21			P021	Return criteria SWIFT fields can only be selected if the query refers to accounts you are responsible for.
P24			P024	No Broadcast Information found.
P25			P025	Central bank does not support the Proprietary Home Account interface.
P26			P026	The Proprietary Home Account is not available.
P27			P027	Generic error generated by PHA.
P30			P030	Only one occurrence of the element <AcctOwnr> per message is allowed.
P31			P031	The modification or removal of a multilateral limit is allowed only once per message.
P32			P032	The same counterpart-BIC is only allowed not more than once per message.
P33			P033	Invalid use of <AICurLmts> or <AIDfltLmts>.
P34			P034	Search criteria PmtFr/Mmbld and PmtTo/Mmbld are only allowed once per request.

9 Technical Specifications

9.5 Entry check
9.5.2 Error codes

SSP Code	Y-copy	V-shape	XML	Description
P35			P035	Country code(s) in PmtFr/Ctry and PmtTo/Ctry must not differ.
P37			P037	You cannot set CreditDebitIndicator to TRUE if your query applies to several accounts.
P38			P038	BICs have to be unique - A group member may only have one sequence number.
P50			P050	If element <PmtInstrStsDtTm> is used, within <PmtInstrSts> it is only allowed to search for <FnlSts>STLD</FnlSts>.
P51			P051	BIC Bilateral Counterpart does not exist.
P52			P052	C Bilateral Counterpart must not indicate a member of a Virtual Account.
P53			P053	RTGS account does not exist or is not valid
P54			P054	Sub-account does not belong to the RTGS account.
P55			P055	Account does not exist or is invalid.
P56			P056	Invalid credited account.
P57			P057	Invalid debited account.
P58			P058	Both credited and debited account are mandatory.
P59			P059	Either credit account or debited account must be present.
P60			P060	Only valid BICs are allowed.
P61			P061	For accounts without non-liability of cover, this function is not allowed.
P62			P062	BIC must be valid and have an RTGS account.

9 Technical Specifications

9.5 Entry check
9.5.2 Error codes

SSP Code	Y-copy	V-shape	XML	Description
P65			P065	Sub-account not known in PM or not connected with AS.
P66			P066	The order was rejected because it was received after an end of procedure message (out of the procedure time frame).
P67	L6		P067	Liquidity on the debited account is not sufficient.
P68	L7		P068	There is a highly urgent payment in the queue.
P70			P100	Function is only possible for AS: "info period", all other: "warehoused", "pending" (but not for change earliest debit time) and "earmarked".
P71			P101	You are not allowed to revoke the payment(s).
P72			P102	Function is not available for AS payments.
P73			P103	Function is not available for AS payments settlement procedure 5 and 6.
P77			P107	Limit value must be 1 million or more. The value 0,00 is possible for deletion of limits.
P78			P108	Function is only available for status open-pending.
P80			P110	You are not allowed to increase/decrease the payment(s).
P81			P110	You are not allowed to change the priority of the payment(s).
P82			P112	You are not allowed to change the Earliest Debit Time of the payment(s).
P83			P113	You are not allowed to change the Latest Debit Time of the payment(s).
P85			P115	Requested time must be before closing time of

9 Technical Specifications

9.5 Entry check
9.5.2 Error codes

SSP Code	Y-copy	V-shape	XML	Description
				SSP.
P86			P116	Only one date for Execution Date is allowed.
P87			P117	Only responsible Central Banks can agree or disagree to the settlement.
P88			P118	Function is only possible, if the status of payment/file is "accounting stopped due to exclusion" and the value date is the current businessday.
P89			P119	New setting of earliest or latest debit time is not possible.
P91			P121	New EarliestDebitTime is after the permitted LatestDebitTime.
P92			P122	New Latest Debit Time is before specified Earliest Debit Time.
P93			P123	Requested time must be later than the current system time.
P94			P124	Requested time must be later than opening time of SSP.
P95			P125	Date is not the current value date.
P96			P126	Date is not the current SSP business day.
P97			P127	Initiator DN is the same as used in the underlying writing operation.
P98			P098	Only the central bank of the excluded settlement bank or of the excluded ancillary system can agree or disagree on this payment.
P99			P099	No authorisation. The GoA manager has no longer access to payments of an excluded participant, which was previously member of his GoA.

9 Technical Specifications

9.5 Entry check
9.5.2 Error codes

SSP Code	Y-copy	V-shape	XML	Description
T00			SPAS	Liquidity transfer partially settled.
T10			T010	T2S related value added service package required.
T20				Only possible if Push Liquidity message is sent to T2S.
T21				T2S Receipt already received.
T22				A competing order is being processed for this business case.
T23				Only possible if Pull Liquidity message is sent to T2S.
T24				Only possible if Push Liquidity message is sent to TIPS.
T25				TIPS Receipt already received.
T26				Only possible if Pull Liquidity message is sent to TIPS.
T32			T032	Invalid status code.
T33			T033	Invalid status category.
T40			T040	Double Message Identification.
T41			T041	Double Instruction Identification.
T42			T042	Double End-to-End Identification.
T50			T050	Transfer not supported. LT can only be from RTGS account to DCA and vice versa.
T51			T051	Invalid debit account type.
T52			T052	Invalid credit account type.

9 Technical Specifications

9.5 Entry check

9.5.2 Error codes

SSP Code	Y-copy	V-shape	XML	Description
T53	TS		T053	Transfer not supported. LT can only be from RTGS account to TIPS Account and vice versa.
T54	T4			Field 58 - option A with BIC of direct participant or DCA account owner is mandatory.
T55	T5			Field 58 account line - only a valid DCA number is allowed.
T56	T6		T056	Message type not supported.
T57	T7			If field 52 is used, option A with BIC of a direct participant is mandatory.
T58	T8			If field 52 account line is used, it must be filled with a valid RTGS account ID.
T59	T9			If field 53 is used, option A with BIC and account ID of a EURO DCA must be stated.
T60	T0			Field 72 - invalid using code word.
T61	TC			Invalid code word - supported codes in F13C are: FROTIME, TILTIME, REJTIME
T62	C2		T062	Cut-off time for T2S transfers has been reached.
T63	F3			F13C settlement times are only accepted if message is sent during day trade phase.
T64	F4			F13C settlement times cannot be processed in case of Pull Liquidity from T2S.
T65			T065	Transfer of excluded participant rejected after disagreement from CB.
T66	C6		T066	Transfer of excluded participant rejected by EoD process.

9 Technical Specifications

9.5 Entry check
9.5.2 Error codes

SSP Code	Y-copy	V-shape	XML	Description
T67			T067	Immediate rejection due to insufficient liquidity.
T68			T068	Rejection of payment by EoD process due to insufficient liquidity.
T70	TA			Amount has to be larger than zero.
T90			T090	No matching business case - invalid reference.
T91			T091	Business case already closed.
T92			T092	Unexpected Receipt
T93			T093	NAK received
T96			T096	Liquidity Transfer unsettled in TIPS but negative Receipt from TIPS is missing - reasons under investigation.
T97	TS		TIPS	Rejected by TIPS - Details provided by TIPS error code.
T98			T098	Undelivered message for T2S
T99	TS		T2SR	Rejected by T2S - Details provided by T2S error code.

SSP related error codes

The following error codes are only used in order to inform a CB about an error.

SSP code	Y-copy	V-shape	XML	Description
D00	-	-	-	Unknown error
D01	-	-	-	Domestic RTGS system is down

9 Technical Specifications

9.5 Entry check

9.5.2 Error codes

SSP code	Y-copy	V-shape	XML	Description
D02	-	-	-	Delay too long
U01	-	-	-	Field 53/58 is not filled with BIC of CB
U02	-	-	-	Responsible CB of BIC in field 58 is not equal to CB in field 53
U03	-	-	-	BIC is not in the BIC directory

10 Migration and test procedures

Responsibilities of the CBs

Each individual CB is responsible for supporting and monitoring the migration of its customers.

Country migration model

The SSP offers two options for the national migration to a CB and its banking community: the “Phased Approach” and the “National Big Bang”.

- “Phased Approach”

Some pieces of the current infrastructure co-exist with the SSP for a period of time, in order to allow for a smoother migration. Some RTGS transactions are settled in the SSP from day one, while the rest of the business continue to be settled on proprietary home accounts for an interim period lasting a maximum of four years (the “transition period”).

- “National Big Bang”

All current systems are dismantled the moment the CB migrates to the TARGET2 single shared platform (SSP). All payment transactions are included in the SSP from day one, meaning that all migration actors have to be prepared to settle directly in the SSP from the very beginning.

Scope

Test procedures make a distinction between:

- Procedures applicable at country level when a whole national banking community joins TARGET2
- Procedures applicable at participant level when a new participant joins the TARGET2 outside of any country connection or when an existing participant wants to change any of its major components
- Procedures applicable to changes to the SSP

Codewords for special purposes

In some situation the need may arise to identify transactions in order to allow the application to treat them according to the underlying specific needs.

Note: The usage of these specific codewords is not mandatory in general, but necessary in the following cases to treat them in a specific way (not “normal” payment processing):

1. payments to be settled in PM during a migration weekend and
2. payments executed in the live environment for testing purposes.

During the weekend, when a community migrates to the SSP, the balances have to be moved from the “old” RTGS system and/or accounting system to PM. This can be done via standard MT 202.

After a peculiar event took place in the SSP world, it might be necessary that some payments are executed during the weekend with value date of the following Monday. Such special events are, just to mention the most relevant ones, the implementation of a new SSP release, the periodical halfyearly rotation between the two PAPSS regions, a new country joining the SSP.

It is worth to stress that, since these payments are processed in the live environment, they move real funds from the debtor’s to the creditor’s account.

In order to identify all these kinds of transfers for both routing and processing purposes, a couple of specific code words to be quoted in field 72 of the relevant MT 103/103+/202/202 COV have been envisaged and they are respectively

- MIGRPAY for the case under 1 and
- LIVEPAY for the one described under 2.

As in all SWIFT messages, such code words have to be put between slashes (“/”).

Glossary and Abbreviations

Note: Terms and abbreviations are listed in alphabetical order. In the case only the abbreviation is used in the ICM User Handbooks the term is explained afterwards, otherwise a reference is made.

3CB

Banca d'Italia, Banque de France, Deutsche Bundesbank

4CB network

The 4CB network is the common internal technical network of the TARGET2 and T2S providers Banca d'Italia, Banque de France, Deutsche Bundesbank and Banco de Espana.

A

A2A

Application-to-application

In this approach, communication is directly between applications customer's back office and the ICM of the SSP. Information and messages can be transferred to in-house applications and used further. Control activities are also automated.

Adjustment Balance

End of day balance of the current day which is necessary to fulfil minimum reserve under the condition that all following end of day balances are exactly the minimum reserve.

Algorithm

An algorithm is a mathematical method to provide a smooth, fast and liquidity saving resolution of the payment queue, for example by taking offsetting payment flows into account.

Ancillary system

Ancillary systems are:

- retail payment systems (RS)
- large value payment systems (LVPS)
- foreign exchange (FX) systems
- money market systems

- clearing houses
- securities settlement systems (SSS)

Ancillary System Interface

The Ancillary System Interface (ASI) is a standardised interface to the Payments Module (PM) which can be used by ancillary systems (ASs) to perform the cash clearing of their business.

Ancillary system manager

By means of the ASI the AS manager initiates the settlement procedures of an AS.

ARC

Asynchronous Remote Copy

AS

See ancillary system

ASI

See Ancillary System Interface

AS Technical Account

Account offered in TARGET2 for specific use of ancillary systems.

Authentication

The methods used to verify the origin of a message or to verify the identity of a participant connected to a system and to confirm that a message has not been modified or replaced in transit.

Auto collateralisation

The auto collateralisation is a specific mechanism used to provide additional liquidity to the SSS settlement process.

This technique is based on the automatic interaction between the collateral manager, the SSS and the SSP to perform collateralisation functions (eg eligibility checks, valuation of collateral) and the related increase of liquidity.

The auto collateralisation is activated during the SSS settlement process to cope with liquidity shortage of a participant: the collateral to be transferred is

automatically selected by the SSS on behalf of the participant based on a specific pre-authorisation.

Two distinct auto collateralisation techniques are currently used by the SSSs:

- firm collateralisation (collateralisation on stock: participants single out the eligible securities that could be used)
- self collateralisation (collateralisation on flows: with securities deriving from the settlement process itself)

Available liquidity

Credit balance on the account plus collateralised credit line for overdraft (if available).

B

Backup payments

Owing to a breakdown a direct PM participant's system may be unavailable for the rest of the business day. In order to avoid liquidity concentration on his account or rather to enable him to fulfil his payment obligations against CLS, EURO1 or STEP2, the respective PM participant has the possibility to make backup payments. Backup payments are initiated via ICM. Two kinds of backup payments are available:

- Backup liquidity redistribution payments are used to reallocate the liquidity that has accumulated on the defaulting participant's account. As soon as the defaulting PM participant is once again able to do so, the original single payments belonging to the backup liquidity redistribution payments previously made are submitted to the PM and the recipients of such backup liquidity redistribution payments have to return the backup liquidity redistribution payments.
- Backup contingency payments are used to fulfil obligations arising from settlement or pre-fund payments on time. The backup contingency payment replaces the original payment.

Glossary and Abbreviations

Batch	A group of orders (payment orders and/or securities transfer orders) to be processed as a set.
BIC	Business Identifier Code
BIC-8	The first 8 characters of the BIC, when used for addressing purposes, are called destination.
BIC-11	In addition to the first 8 characters of the BIC, an optional branch code of 3 characters is used to identify any branch or reference of an institution.
BIC directory	Directory published by SWIFT. It contains the business identifier codes (BIC) of the credit institutions.
Bilateral Key Exchange	A SWIFT service for the exchange of bilateral keys between correspondents over the SWIFT network, using enciphered data carried with dedicated messages.
BIS	Bank for International Settlements
BKE	See Bilateral Key Exchange
Blocked amount	<p>In PHA certain amounts may be blocked for future debits, eg in the context of bulk payments.</p> <p>A blocked amount also refers to funds on a sub-account notified to an AS for settlement of the respective AS.</p>
Broadcast	Information message simultaneously available to all or a selected group of SSP participants.
Business case	Any kind of order of a participant (eg liquidity transfer, payment etc.) and all the associated messages (eg MT 096, MT 097, ACK from SWIFT, ...).

Business continuity

Payment system's arrangements which aim to ensure that it meets agreed service levels even if one or more components of the system fail or if it is affected by an abnormal external event. Include both preventative measures and arrangements to deal with contingencies.

Business day

The business day in PAPSS starts at 18.45 (d-1) with the Start-of-day processing and ends at 18.45 (d) with the completion of the end-of-day processing.

C

camt-Cash management

Standard for XML messages to be used by participants to manage their TARGET2 business.

Cash clearing

A method for clearing futures contracts in which positions are periodically marked to market and resulting obligations are satisfied by cash payments, known as variation margin.

CB

Central bank

CB customer

Entity that is not allowed to open accounts in PM according to TARGET Guideline (eg correspondent bank not located in EEA).

CB Customer Liquidity Bridge

Entity that is not allowed to open accounts in PM according to TARGET Guideline (eg correspondent bank not located in EEA).

CB customer's account

Account with a CB in the Home Accounting Module, belonging to an entity that is not authorised, according to TARGET Guideline, to have an RTGS account.

Cbo

Combo box

CBT

SWIFT Computer Based Terminal

CCBM	<p>Correspondent Central Banking Model</p> <p>A mechanism established by the European System of Central Banks (ESCB) with the aim of enabling counterparties to obtain credit from the central bank of the country in which they are based using collateral held in another country. In the CCBM, a CB acts as custodian for the other CBs with regard to the securities held in its domestic securities settlement system.</p>
CCP	<p>Central Counter Party</p> <p>An entity that interposes itself between the counterparties to the contracts traded in one or more financial markets, becoming buyer to every seller and the seller to every buyer.</p>
Central securities depository	<p>An entity, which holds and administrates securities and enables securities transactions to be processed by book entry. Securities can be held in a physical but immobilised or dematerialised form (ie so that they exist only as electronic records). In addition to safekeeping and administration of securities, a central securities depository may incorporate clearing and settlement and assets servicing functions.</p>
CEST	<p>Central European Summer Time</p>
CET	<p>Central European Time</p>
CI	<p>See credit institution</p>
Clearing	<p>The process of calculating the mutual obligations of market participants for the exchange of securities and money. It may include the process of transmitting, reconciling and, in some cases, confirming payment or securities orders.</p>
Clearing house	<p>An entity hosting a clearing system, which consists of a set of rules and procedures whereby financial institutions present and exchange data and/or</p>

documents relating to funds or securities transfers to other financial institutions at a single location. The procedures often also include a mechanism for the calculation of participants' mutual positions, possibly on a net basis, with a view to facilitating the settlement of their obligations in the settlement system.

Closed User Group

A subset of customers grouped for the purpose of their use of the relevant SWIFT services and products when accessing the Payments Module.

CLS

Continuous Linked Settlement

An entity that interposes itself between the counterparties to the contracts traded in one or more financial markets, becoming buyer to every seller and the seller to every buyer.

CM

Former Contingency Module
see Enhanced Contingency Solution (ECONS I).

Collateral

An asset or a third party commitment that is accepted by the collateral taker to secure an obligation to the collateral provider vis-à-vis the collateral taker. Collateral arrangements may take different legal forms; collateral may be obtained using the method of title transfer or pledge.

Collateral manager

A system managed by the central bank or by a third party (on behalf of the central bank) that interacts with the SSP in order to manage the intraday credit line in PM and the access to the marginal lending function in the Standing Facilities (Module).

Collateral pool

Assets owned by members of a transfer system that are collectively available to the systems collateral to enable it to obtain funds in circumstances specified in its rules.

Co-Management function

The aim is to allow small banks to manage directly their reserve requirements, but delegate cash flow management to another bank. Such a bank has to be a direct participant in the SSP and is the so-called co-manager.

Confidentiality	The quality of being protected against unauthorised disclosure.
Connected payment	Payments by a CB or AS to a participant that trigger a change in the credit line of this participant and an immediate debit/credit of its account to compensate the change in this credit line.
Contingency Module	See Enhanced Contingency Solution (ECONS I).
Contingency Network	The Contingency Network is an alternative network to access the TARGET2 system in case of an regional or global outage of the SWIFT network to ensure that a limited number of very critical and critical payments would be processed by the NCBs in contingency situations. The Contingency Network is based on CoreNet.
CoreNet	CoreNet is an ESCB closed network interconnecting all National Central Banks and providing them multiple services. In the SSP context CoreNet is used as a contingency network for PAPSS access. It is also used to access CRSS reporting service as an alternative to the Swift access.
Country Code	Two letter code to identify the country where the respective entity is located; eg a country code is used in the SWIFT BIC (digits 5 and 6) of the 8-digit or 11-digit BIC.
CRAKS	Customer Relationship And Knowledge of System It gathers all services needed to support customer relationship and knowledge of payment systems by the central banks.
CRAKS1	SSP block of services dedicated to CBs and to be used on an optional basis by them, which provides services of queries and reports on historical data.
CRAKS3	SSP service dedicated to CBs and to be used on an optional basis by them, which provides support to the CBs in their business relationship with their customers. It consists of the customer support and of the Events & Comments services.

Credit institution	<p>The definition given to a “bank“ in the European Union. The First EC Banking Directive defines it as an undertaking whose business is to receive deposits or other repayable funds from the public and to grant credits for its own account.</p>
Credit line	<p>Maximum collateralised overdraft position of the balance on an RTGS account in PM or on the PHA.</p> <p>The respective participants can get information about changes regarding their credit lines via the ICM. Changes of credit lines will be executed immediately. In case of a reduction of a credit line this change has a “pending“ status if the reduction would lead to an uncovered overdraft position. The change will be executed when the overdraft position is covered by the reduced credit line.</p>
Credit transfer	<p>A transfer of funds made on the basis of a payment order or sometimes a sequence of payment orders made for the purpose of placing funds at the disposal of the payee. The payment order may be processed via several intermediaries and/or via one or more funds transfer system.</p>
CRISP	<p>Consumption Report and Invoicing Support Process</p> <p>SSP block of services dedicated to CBs and to be used on an optional basis by them which provides billing services.</p>
CRM	<p>See Customer Relationship Management</p>
CROSS	<p>Core Requirements on Statistics and Storage</p> <p>SSP service dedicated to CBs and to be used on a mandatory basis by them which comprises archiving and storage services, files for billing calculation. The CROSS is offered on the CRSS platform.</p>
Cross AS settlement	<p>Procedure enabling an Ancillary System (normally CSDs) using ASI procedure 6 to move dedicated liquidity of a settlement bank to another.</p> <p>Ancillary System using ASI using procedure 6. The settlement takes place on the technical account – procedure 6 real-time for real-time AS and on the sub-accounts for interfaced AS.</p>

Glossary and Abbreviations

Cross CSD	See Cross AS settlement
Cross-CB payments	Payments between participants of different CB on the SSP.
Cross-PM payments	Payments between one participant of a CB on the SSP and another participant of an external CB which migrates later on (use of the interlinking).
CRSS	<p>Customer Related Services System</p> <p>The CRSS is one of the two technical configurations of the SSP (the other is the PAPSS). On this technical configuration the core and optional services reserved to central banks only are totally or partly implemented, ie archiving and other CRSS mandatory services (CROSS), billing optional services (CRISP), query and report optional services (CRAKS1), customer relationship optional services (CRAKS3).</p>
Cryptography	The application of mathematical theory to develop techniques and algorithms that can be applied to data to ensure goals such as confidentiality, data integrity and/or authentication.
CSD	See central securities depository
CUG	See Closed User Group
Customer	Entity which is not a participant (direct or indirect) and which uses the service of a participant to exchange transactions in the system. The CBs as participants can also have customers.
Customer Relationship Management	Term referring to the management by CBs of customer-oriented information related to participants and customers (CIs, AS, other customers eg CB customers in HAM). The SSP provides in particular two optional modules for customer relationship management: billing optional services (CRISP), and customer relationship optional services (CRAKS3), which are partly implemented on the CRSS platform.

D

Daylight processing	See Day Trade Phase
Day trade phase	Period of time in PAPSS between 7.00 and 18.00.
Dedicated account	Account in the PM on which dedicated liquidity for ancillary system settlement is held. This can be either a sub-account (interfaced model) or a technical account – procedure 6 real-time (real-time model).
Dedicated liquidity	Liquidity held on a PM sub-account or technical account – procedure 6 real-time to allow the settlement of an ancillary system.
Delivery	Conditional or unconditional transfer of financial instruments by book entry of physical exchange.
Delivery versus payment	A link between securities transfers and funds transfers system that ensures that delivery occurs if, and only if, payment occurs.
Deposit facility	A standing facility of the Eurosystem which counterparties may use to make overnight deposits at a national central bank, which are remunerated at a pre-specified interest rate.
Depository	An agent with the primary role of recording securities either physically or electronically and may keep records of the ownership of these securities.
Direct debit	An authorised debit on the payer's bank account initiated by the payee.
Direct participant	A participant in a system that directly carries out transactions with other participants in the system. He can perform all activities allowed in the system without intermediary. In some systems direct participants also carry out transactions on behalf of indirect participants.

Distinguished name	<p>The X.500 notation for an entity.</p> <p>The SWIFTNet identifiers (for example, institution's address, certificate's name of an application or a user) follow this standard. The left part always contains the most detailed information.</p> <p>Example: certificate name of a user: cn=john-smith,o=bicabebbb,o=swift</p>
DN	Distinguished name
DN Suffix	The first part of a complete DN which is used to assign a BIC-8 or BIC-11 to a requesting DN. Therefore, in general the DN suffix consists of the first two levels of the DN tree in case of BIC-8 (ie o=swift o=BIC8) or up to the level of the branch identifier in case of BIC-11 (eg o=swift o=BIC8 ou=branch identifier or o=swift o=BIC8 ou=orgunit ou=branch identifier).
DVP	See delivery versus payment
E	
EBA	Euro Banking Association
ECB	European Central Bank
ECB account	See NCB's ECB account
ECB mirror account	Account held by the ECB for each CB in the PM on which the bookings done on the NCBs' ECB accounts will be "mirrored".
ECONSI	See Enhanced Contingency Solution
ECSDA	European System of Central Banks
EEA	European Economic Area
Encryption	The use of cryptographic algorithms to encode clear text data (plaintext) into ciphertext to prevent unauthorised observation.

Enhanced Contingency Solution

Common tool for the management of the emergency situations in order to process critical and very critical payments.

EPC

European Payments Council

ESCB

European System of Central Banks

EU

European Union

F

Favourites

Counterpart BICs which are dealt with very frequently. Users of a direct SSP participant are able to define them as “favourites”. Those favourites are valid for all users of the respective participant. In case a participant BIC has been selected via the Profile Selection of ICM, the favourites of the selected participant BIC are displayed.

FIFO

First In, First Out: processing sequence in which the payment orders are treated in the same sequence as they arrived (ie: the first payment arrived is treated first, the latest one is treated at the end). The relevant timestamp of each payment is arrival in the SWIFT Interface of SSP

FIFO by-passing

The system tries to process the first transfer in the queue, but if that cannot be executed owing to lack of funds it then tries to settle the next transfer instead; also called Bypass FiFo.

Final settlement

The discharge of an obligation by a transfer of funds and a transfer of securities that have become irrevocable, irreversible, or not annulable.

Firewall

A hardware- and/or software-based system that is used as an interface between the internet and a computer system to monitor and filter incoming and outgoing communication.

G

GARI MT

Component of the SWIFT Interface. Communication software for the exchange of SWIFT FIN messages.

GARI NT	Component of the SWIFT Interface. Communication software for the exchange of XML messages.
General Ledger	The General Ledger sometimes known as nominal ledger, is the main accounting record of a business which uses double-entry bookkeeping.
Gridlock	A situation that can arise in a funds or securities transfer system in which the failure of some transfer orders to be executed (because the necessary funds or securities are unavailable) prevents a substantial number of other orders from other participants from being executed.
Gross settlement system	A transfer system in which the settlement of funds or securities transfer orders occurs individually (on an order by order basis).
Group of accounts	See liquidity pooling functionality
Guarantee fund mechanism	Mechanism to provide the complementary liquidity needed according to predefined rules in case an AS cannot settle using the settlement banks liquidity only.
Guarantee funds account	Account held on the SSP for maintaining or collecting funds allocated to the settlement of balances of an ancillary system in case of failure of settlement bank(s).
H	
HAM	See Home Accounting Module
Home account	Account held by CBs outside of the Payments Module, eg <ul style="list-style-type: none">• for entities that cannot have the status of a direct participant in PM• for entities allowed to open RTGS accounts that are indirect PM participants (or do not participate in PM neither as direct nor indirect)• for RTGS account holders for the settlement of operations which are not processed in the Payments Module

Home Accounting Module

The home accounts are managed by the HAM or by a proprietary accounting system.

The Home Accounting Module (HAM) is an optional module. In the case, a central bank opts for the use of this module different standardised account services are offered for the central bank and its customers.

Home CB

CB, where the direct participant is located.

Host CB

CB, via which a direct participant uses the possibility of remote access.

HTTPS

Hyper Text Transfer Protocol Secure

It is a protocol which is used to secure the data exchange in case of access over internet.

I**IAM**

See Identity and Access Management

IBP

See Internet-based participant

ICM

See Information and Control Module

Identity and Access Management

Identity and Access Management (IAM) is the evolution of the current ESCB Directory Services and provisioning tool (namely EUMIDES). IAM is created as a comprehensive platform for managing secure access and associated rights to Eurosystem and ESCB applications. TARGET2 uses the security services for user authentication and authorisation as well as the certificate management provided by IAM to access the Contingency Network and the CRSS reporting services via CoreNet.

Indirect participant

Indirect participants are distinguished from direct participant by their inability to perform some of the system activities performed by direct participants, in particular they do not hold RTGS accounts. Indirect participants require the services of direct participants to perform those activities on their behalf (settling the payments input to the transfer system).

Information and Control Module

Mandatory and unique functional interface between the direct participants and the Payments Module (PM) and the other optional modules like

- Home Accounting Module (HAM)
- Reserve Management (Module) (RM)
- Standing Facilities (Module) (SF)
- Static Date (Management) Module (SD)

Integrity

The quality of being protected against accidental or fraudulent alteration of transmission and of storage, or the quality of indicating whether or not alteration has occurred.

Internet-based participant

An entity which is connected to the SSP via Internet. ICM offers via U2A customised functions with regard to the needs of the Internet-based participant.

Intra-CB payment

Payment between participants of the same CB on the SSP.

Intraday credit

Credit extended and reimbursed within a period of less than one business day; in a credit transfer system with end-of-day final settlement, intraday credit is tacitly extended by a receiving institution if it accepts and acts on a payment order even though it will not receive final funds until the end of the business day. It can take the form of:

- a collateralised overdraft or
- a lending operation against a pledge or in a repurchase agreement

Intraday liquidity

Funds which can be accessed during the business day, usually to enable financial institutions to make payments on an intraday basis.

ISO

International Organisation for Standardization

The TARGET2 to T2S connectivity will be based on the ISO20022 standard foreseen by T2S specifications. TARGET2 implements a set of ISO20022 cash management messages which are necessary to properly interact with T2S.

L

Legal entity

Credit institution directly participating in the SSP through (also AS when participating as a direct participant) one or more participants/accounts in the PM and/or HAM is called a legal entity. This allows to group general information about this credit institution in the Static Data (Management) Module.

Limit

Amount for normal payments a direct PM participant is willing to pay to another participant (bilateral limit) or to the other participants (multilateral - limit towards whom no bilateral limit is defined), without having received payments (that are credits) first. For a direct participant it is possible to establish standing orders or current bilateral (respectively multilateral) limits.

A normal payment can only be settled if it does not breach the respective limit. Setting limits is only possible vis-à-vis RTGS account holders (in case of a group of accounts: only possible vis-à-vis the virtual account) in the SSP. It is not possible to use limits vis-à-vis participating CBs. Incoming urgent payments from a participant towards whom a bilateral/multilateral limit is defined also affect the bilateral/multilateral position.

Liquidity pooling functionality

A facility, based on the idea of allowing TARGET2 participants to pool their RTGS accounts in an account group. Such an account group consists of one or more account(s) held by a direct PM participant(s) which has a capital and/or management link.

The following three options are offered:

- virtual accounts (only for euro area participants) and
- consolidated information (available also to participants from non-euro area countries).

- banking group monitoring (only for CB)

Liquidity transfer

Transfer of funds between accounts of the same participant or between two accounts of a group of accounts.

There are two kinds of liquidity transfers available:

- current:
transfers executed immediately after entry if sufficient liquidity is available
- standing order
transfers of fixed amounts executed regularly at certain points of time, eg liquidity injections from HAM accounts to RTGS accounts at the start of the business day. Changes of standing orders become effective on the following business day.

It is also a generic settlement procedure (procedure 1), where liquidity is transferred from/to a technical account – procedure 6 real-time to/from a settlement bank's RTGS account.

Note: Although still present in TARGET2, procedure 1 should not be used anymore since it is limited to daylight processing only. For details please refer to the Guideline on TARGET2 and its amendments (<https://www.ecb.europa.eu/ecb/legal/1003/1349/html/index.en.html>).

M

MAC

Message Authentication Code

Mandated payment

Payment initiated by an entity that is not party to the transaction (typically by a CB or an AS in connection with ancillary system settlement) on behalf of another entity. A CB sends a credit transfer (with specific message structure) on behalf of the failed direct participant (only in case of contingency situations).

Marginal lending facility

A standing facility of the Eurosystem which counterparties may use to receive overnight credit from a CB at a pre-specified interest rate against eligible assets.

In general possible options:

- **Marginal lending on request**
Use on request of the participant in general needed for the fulfilment of reserve requirement.
- **Automatic marginal lending**
Automatic transformation of intraday credit in overnight credit at the end of the day.

Message type

A specific type of SWIFT messages as identified by a three-digit number. The first digit defines the message category, indicating the general use of the message, the second digit defines the message group and the third digit defines particular message function.

MFI

See Monetary Financial Institution

MIR

Message Input Reference

Mirror account

See Technical account – procedure 6 real-time

Monetary Financial Institution

A Monetary Financial Institution (MFI) comprise resident credit institutions as defined in Common law, and other resident financial institutions whose business is to receive deposits and/or close substitutes for deposits from entities other than MFIs, and for their own account (at least in economic terms), to grant credits and/or make investment in securities.

MOR

Message Output Reference

MT

see message type

N

NCB	National Central Bank
NCB's ECB account	Account which is necessary to record the CB's asset/liability position vis-à-vis the ECB in respect of cross-border transactions.
Netting	An agreed offsetting of positions or obligations by participants in a clearing or settlement system. The netting reduces large number of individual positions or obligations to a smaller number of obligations or positions. Netting may take several forms which have varying degrees of legal enforceability in the event of default of one of the parties.
Netting by novation	An agreement where obligations from individual transfer orders are netted and replaced by new obligations. The parties to the new obligations may be the same as those to the existing obligations, or, in the context of some clearing house arrangements, there may be additionally substitution of parties.
Night time processing	Period of time for settlement of AS transactions (settlement procedure 6) between 19.30 h and 6.45 h (interruption for technical maintenance between 22.00 h and 1.00 h).
Not FIN-connected BIC (former Non-SWIFT-BIC)	The business identifier code of a financial institution not connected to the SWIFT FIN network. These BICs (former Non-SWIFT-BICs) are identified by the SWIFT Network Connectivity flag set to "Not connected".
<h2>O</h2>	
Offsetting	Offsetting in TARGET2 aims to increase the capacity of the system to settle payments, thereby reducing queues, speeding up the settlement process and reducing the need of intraday liquidity. A bilateral or multilateral offsetting mechanism considers payments in the queues of participants and tries to settle them simultaneously on a gross basis within one legal and logical second.
Overnight credit	See marginal lending facility
Overnight deposit	Deposits with next-day maturity

P

PAPSS

Payment and Accounting Processing Services Systems

One of the two technical configurations of the SSP (the other one is the CRSS). The following modules of the SSP are implemented on the PAPSS:

- Enhanced Contingency Solution (ECONS I)
- Home Accounting Module (HAM)
- Information and Control Module (ICM)
- Payments Module (PM, including the interface for ancillary systems)
- Reserve Management (Module) (RM)
- Standing Facilities (Module) (SF)
- Static Data (Management) Module (SD)

Parts of the following services are also implemented on the PAPSS:

- CRISP
- CRAKS3

Participant

An entity which is identified/recognised by the system, is bound by rules of the system and is allowed to send and capable to receive transfer orders, either directly (as a direct participant) or indirectly (as an indirect participant).

Payment

In the SSP two general kinds of payments are possible for direct participants:

- customer payments (MT 103, MT 103+)
- bank-to-bank payments (MT 202, MT 202 COV, MT 204)

Payment message/instruction	An order or message to transfer funds (in the form of a monetary claim on a party) to the order of the beneficiary. In TARGET2 the order may relate either to a credit transfer or a direct debit.
Payments Module	Mandatory module which allows the settlement of payments in the RTGS account, held by all direct participants. In addition, it offers advanced services for liquidity management, for the communication with participants and ancillary systems.
PHA	See proprietary home account
PKI	Public Key Infrastructure
Pledge	A delivery of assets to secure the performance of an obligation owed by one party (debtor) to another (secured party). A pledge creates a security interest (lien) in the assets delivered, while leaving ownership with the debtor.
PM	See Payments Module
Priority	<p>In general, payments are settled immediately, if sufficient liquidity is available on the RTGS account of the participant. Considering their urgency, they can be submitted by the sender using priorities:</p> <ul style="list-style-type: none">• highly urgent payments (priority class 0)• urgent payments (priority class 1)• normal payments (priority class 2). <p>Payments which cannot be settled immediately are queued according to their priority (highly urgent queue, urgent queue, normal queue). Priorities can be changed via the ICM.</p>
Profiling information	Information delivered to CBs on the past behaviour of a participant or a group of participants, aggregated over a past period, and aimed at being comparable with current business day information.
Proprietary home account	Account held by CBs outside the SSP eg

- for entities that cannot have the status of direct participants in PM
- for entities allowed to open RTGS accounts that are indirect PM participants (or do not participate in PM neither as direct nor as indirect)
- for RTGS account holders for the settlement of operations which are not processed in the PM

The proprietary home accounts are not implemented in the SSP but within every CB.

Proxy	Component of the SWIFT Interface
PSMN	See Payment Settlement Message Notification
PSMR	See Payment Settlement Message Request
Q	
Queuing	An arrangement whereby transfer orders are held pending by the sending participant or by the system until it can be processed according the rules of the system.
R	
RAD	Restart after disaster
Raw data file	The raw data file <ul style="list-style-type: none">• serves as check file for the verification of the positions of the General Ledger• can be used for archiving purposes of CBs not using CRAKS1 services• can be used for own reports of the CBs
RBAC	Role Based Access Control

	<p>An optional SWIFTNet facility for controlling end users' and applications' access to service functions.</p>
Real-time gross settlement	<p>The continuous (real-time) settlement of funds or securities transfers individually on an order by order basis (without netting).</p> <p>Real-time gross settlement (RTGS) system</p> <p>A settlement system in which processing and settlement take place in realtime on a gross basis. An RTGS system may provide centralised queues for orders which cannot be settled at the time of the submission due to insufficient funds or quantitative limits on the funds.</p>
Remote participant	<p>A direct participant in the SSP which does not have any representation in the SSP country via he takes part in the SSP.</p>
Repo	<p>See repurchase agreement</p>
Repurchase agreement	<p>A contract to sell and subsequently repurchase securities at a specified date and price.</p>
Reservation	<p>With the usage of the reservation facility liquidity can be reserved by RTGS account holders for the execution of special transactions with a certain priority class. HAM account holders can use the reservation facility to reserve liquidity for the execution of cash withdrawals. Reservations can be effected and adjusted using the ICM.</p>
Reserve holdings	<p>Liquidity intraday and overnight maintained on the RTGS account at the end-of-day.</p>
Reserve Management (Module)	<p>Module enabling CBs to perform some functionalities for the reserve requirements management, eg verify the minimum reserves fulfilment or calculate the interest to be paid to credit institutions for minimum reserves.</p> <p>The obligation of euro area credit institutions to hold minimum reserves on reserve accounts with their home NCBs. The reserve requirement is determined in relation to certain elements of the credit institutions' balance sheet.</p>

Reserve requirement

Institutions' holding of required reserves are remunerated at the rate of the Eurosystem's main refinancing operations.

RM

See Reserve Management (Module)

RM Interest and Penalty Account

Account held by a CB for performing bookings related to the payment of interest on minimum reserves and to the payment of penalties of a CI which has not fulfilled minimum reserve requirements (optional).

RTGS

See real-time gross settlement

RTGS account

Account managed within the PM and maintained by a direct participant to settle all transactions submitted to and processed by the PM (except for transactions of the AS settlement procedure 6 which are settled on sub-accounts).

S**SAA**

SWIFT Alliance Access

SWIFT Alliance Access is a messaging interface that allows the user to connect in-house applications with SWIFTNet FIN (MT) and MX-based SWIFTSolutions.

SAG

SWIFT Alliance Gateway

SWIFT Alliance Gateway is the single window to all SWIFTNet communications. All SWIFTNet message flows can be concentrated through one interface. This includes applications connected via WebSphere MQ, and also those designed for linking to SWIFTNet Link or based on SWIFTAlliance WebPlatform.

SB

See settlement bank

SD

See Static Data (Management) Module

The full set of institutional arrangements for confirmation, clearing, settlement, custody and registration of securities.

Securities settlement system collateralisation	See auto collateralization
SEPA	See Single Euro Payments Area
Settlement bank	Direct participant which pertains to one or more AS and manages the AS settlement process (eg the determination of settlement positions, monitoring of the exchange of payments, etc.) not only for own purposes but also for other AS participants on its RTGS account (main/sub-accounts).
SF	See Standing Facilities (Module)
SF Interest Account	Account held by a CB for performing bookings related to the payment of interest on Standing Facilities (optional).
Single Euro Payments Area	Term to describe a statues where the euro area has achieved the same degree of integration of payment systems, payment instruments and payment infrastructure as that which is usually in a single-country currency area.
Single Shared Platform	TARGET2 is based on a single technical platform, known as the Single Shared Platform which includes the PAPSS (Payment and Accounting Processing Services Systems) and the CRSS (Customer Related Services System).
SIPN	Secure Internet Protocol Network Secure, high-availability and worldwide virtual private network by SWIFT-based on the International Protocol (IP) and related technologies and provides transfer services required by SWIFTNet services.
SLA	Service Level Agreement
SSP	See Single Shared Platform
SSP OT	SSP Operational Team

SSS	See securities settlement system
Standing Facilities (Module)	The Standing Facilities (Module) is an optional module and enables to manage the overnight standing facilities (deposit facility, marginal lending facility).
Standing facility	<p>A central bank facility available to counterparties on their own initiative. The Eurosystem offers two overnight standing facilities:</p> <ul style="list-style-type: none">• the marginal lending facility and• the deposit facility.
Standing order	Instruction of a direct participant to transfer regularly a fixed amount from his home account to an RTGS account (PM) and also from the RTGS (main) account to the sub-accounts (interfaced model) or to a technical account – procedure 6 real-time (real-time model) or to a T2S Dedicated Cash Account.
Static Data (Management) Module	This module ensures a proper and reliable management of static data by storing all statistic data actually used. It caters for data consistency between all modules of the SSP. Inter alia the Static Data (Management) Module is used to generate the TARGET2 directory.
Sub-account	Specific account, belonging to an RTGS account, holding dedicated liquidity to allow the settlement of an ancillary system.
SWIFT	Society for Worldwide Interbank Financial Telecommunication
SWIFT-based participant	An entity which is connected to the SSP via SWIFT's Secure IP Network.
SWIFT-BIC	A business identifier code of a financial institution connected to the SWIFT network.

SWIFTNet FileAct	File transfer service provided by SWIFT, typically used to exchange batches of structured financial messages and large reports. In the SSP, eg the TARGET2 directory is transferred via the Secure IP Network (SIPN) by SWIFT using the FileAct service.
SWIFTNet InterAct	SWIFT interactive messaging service supporting the exchange of messages between two parties. On the SSP the InterAct service is used for the transfer of XML requests via the Secure IP Network (SIPN) by SWIFT to the ICM.
SWIFT Network connectivity	Status of an entity's connection to SWIFT. The network connectivity can no longer be detected from the BIC. The network connectivity information is combined in one field, displaying the status of an entity's connection to FIN, InterAct, and FileAct messaging services.
SWIFT payment message	An instruction to transfer funds; the exchange of funds (settlement) subsequently takes place over a payment system or through correspondent banking relationships; used for all payments and the related transactions on the SSP.
SWIFT WebAccess	SWIFT service based on the SAML protocol, enabling users to browse remote web servers. In SSP the use of SWIFT WebAccess provides access to the Information and Control Module (ICM) and to the Enhanced Contingency Solution (ECONS I). It replaces the former SWIFTNet Browse service.
T	
T2S	See TARGET2-Securities
T2S Actor in TARGET2	The T2S Actor in TARGET2 is special type of participation in A2A mode which gives CSDs and other credit institutions (eg regional institutions of credit cooperatives or Landesbank for saving banks) which are authorised by the direct participant to offer the service to submit current order liquidity transfers to T2S using XML messages on behalf of TARGET2 direct participants. The T2S Actors in TARGET2 are registered by linking their DN with the BIC of a direct participant in Static Data.

T2S DCA	See T2S Dedicated Cash Account
T2S Dedicated Cash Account	The euro denominated Dedicated Cash Accounts in T2S are used for the settlement of the cash leg of security transactions in central bank money (euro). They are opened by a CB for itself and for the T2S participants under its responsibility and are linked to the respective RTGS accounts of the direct participants in TARGET2. A direct PM participant can send current and standing order liquidity transfers to any euro denominated Dedicated Cash Account in T2S, except DCAs belonging to an excluded participant. At the end of the business day all T2S DCAs must have a balance of zero. The available liquidity on the T2S DCA is automatically transferred to the linked RTGS account in TARGET2.
T2S transit account	The T2S transit account is an offset account in PM used for the routing of all current and standing order liquidity transfers to T2S and vice versa. The T2S transit account is under the responsibility of the ECB.
T2SI	The T2S interface is a dedicated interface build in PM for the processing of pushed and pulled liquidity transfers to T2S using XML messages in the standard required by T2S.
TARGET	Trans-European Automated Real-time Gross settlement Express Transfer.
TARGET2-Securities	The single technical platform of the Eurosystem providing core borderless and neutral securities settlement services in central bank money to central securities depositories and NCBs in Europe.
TARGET working day	The TARGET working day (d) equals the calendar day with the exception of the days when the TARGET system is not operated.
TARGET2 directory	Directory used by participants to find out where a payment has to be addressed by SWIFTNet Y-Copy mode. On a domestic level, it could be used to find the relation between the national sorting codes and the related BICs.
TARGET2 Fees Account	Account held by a CB for the collection of TARGET2 fees of direct participants (optional).
Task	Via the ICM it is possible to transmit

- action orders (eg all kinds of entries) and
- information orders (eg “display“)

to the different modules of the SSP. Action orders transmitted via the ICM are defined as “tasks“.

Technical account

Account used in the context of ancillary systems operations as intermediary account for the collection of debits/credits resulting from the settlement of balances or DVP operations. The balance of such an account is always zero because debits (resp. credits) are always followed by credits (resp. debits) of an overall equal amount.

Technical account – procedure 6 real-time

In fact specific RTGS accounts opened to CBs for the specific use of ACHs, with the real-time model funds held on the technical accounts – procedure 6 real-time are mirrored in the books of ACHs. It is debited or credited in case of liquidity transfer between a participant’s RTGS account in PM and its account in an ACH.

TIPS

TARGET Instant Payment Settlement (TIPS) is a service offered for final and irrevocable settlement for instant payments in central bank money on a 24/7/365 basis.

Transaction Reference Number

An alphanumeric reference of up to 16 characters assigned by the sender to messages sent over the SWIFT network.

Transfer

Operationally, the sending (or movement) of funds or securities or of a right relating to funds or securities from one party to another party by

- conveyance of physical instruments/money,
- accounting entries on the books of a financial intermediary or
- accounting entries processed through a funds and/or securities transfer system.

The act of transfer affects the legal rights of the transferor, transferee and possibly third parties in relation to the money balance, security or other financial instrument being transferred.

TRN	See Transaction Reference Number
TSRC	TARGET Security Requirements and Controls
U	
U2A	User-to-application The objective is to permit direct communication between a participant's users and the ICM. The information is displayed in a browser running on a PC system. Control activities are performed manually by the user.
User	Each participant (direct and indirect)
UTC	Universal Time Coordinates A standard adopted by SWIFT for encoding date and time.
V	
Virtual account	Method for aggregating data among accounts within a group of accounts that are held on the books of euro area CBs. Payments made by holders of an account within a virtual account are checked against the global liquidity of the virtual account, which is the sum of the available liquidity of all accounts composing it.
V-shape	Type of transmission of SWIFT messages on the SSP which is mostly used in the context of payments processed via HAM.
W	
Warehoused Payment	Payments submitted up to five TARGET working days in advance. In this case, the payment message will be warehoused until the day trade phase of SSP with the respective date starts.
Wildcards	In Select Criteria screens and Select screens of the ICM it is possible to search with the following wildcards:

- “*” = one or more characters are missing
- “?” = one character is missing

WOM

Write Once Medium

Medium (eg digital disk) used to archive data. Data cannot be deleted from such medium once written.

X

XML

Acronym for Extensible Markup Language

Subset of Standard Generalized Markup Language (SGML - ISO 8879) designed especially for use on the Web and in Web-based applications.

Y

Y-copy

Standard type of transmission of SWIFT messages on the SSP which is used in the context of payments processed via PM.