



1

2

3

BUSINESS PROCESS DESCRIPTION

4

5

6

7

8

9

10

11

12

13

14

15

Reference:	09.04.01/2012/009335
Author	ECB T2S Programme Office
Date:	1 July 2016
Version:	1.4
Status:	Draft



EUROPEAN CENTRAL BANK

EUROSYSTEM

1	1. INTRODUCTION.....	5
2	1.1 OBJECTIVE AND SCOPE	5
3	1.2 METHODOLOGY	6
4	2. CORE SETTLEMENT PROCESSES	17
5	2.2 CROSS-CSD SETTLEMENT (WITH CSD INSIDE T2S) [T2S.BPD.SETT.CCSD].....	30
6	2.3 EXTERNAL CSD SETTLEMENT (INVOLVING CSD OUTSIDE T2S) [T2S.BPD.ECSD].....	41
7	3. SUPPORTING SETTLEMENT PROCESSES.....	69
8	3.1 MANAGEMENT OF ALLEGEMENT [T2S.BPD.SETT.ALEG].....	69
9	3.2 MANAGEMENT OF CSD VALIDATION HOLD [T2S.BPD.SETT.CSDH]	74
10	3.3 ADMINISTRATION OF CONDITIONAL SECURITIES DELIVERY [T2S.BPD.SETT.COSD]	78
11	3.4 MANAGEMENT OF AUTO-COLLATERALISATION [T2S.BPD.SETT.ACOL].....	88
12	3.5 RESERVATION OR BLOCKING OF SECURITIES POSITION [T2S.BPD.SETT.RBSP]	96
13	3.6 UNRESERVATION OR UNBLOCKING OF SECURITIES POSITION [T2S.BPD.SETT.UUSP].....	103
14	3.7 EARMARKING OF SECURITIES POSITION [T2S.BPD.SETT.EARM]	109
15	3.8 UNEARMARKING OF SECURITIES POSITION [T2S.BPD.SETT.UEAR]	115
16	3.9 RESERVATION OR BLOCKING OF CASH BALANCE [T2S.BPD.SETT.RBCB]	120
17	3.10 UNRESERVATION OR UNBLOCKING OF CASH BALANCE [T2S.BPD.SETT.UUCB].....	127
18	3.11 HOLD OF SETTLEMENT INSTRUCTION [T2S.BPD.SETT.HOLD]	133
19	3.12 RELEASE OF SETTLEMENT INSTRUCTION [T2S.BPD.SETT.RELE]	139
20	3.13 CANCELLATION OF SETTLEMENT INSTRUCTION [T2S.BPD.SETT.CINS].....	145
21	3.14 CANCELLATION OF INTRA-POSITION MOVEMENT [T2S.BPD.SETT.CIPM]	152
22	3.15 CANCELLATION OF INTRA-BALANCE MOVEMENT [T2S.BPD.SETT.CIBM].....	158
23	3.16 AMENDMENT OF SETTLEMENT INSTRUCTION OR RESTRICTION [T2S.BPD.SETT.AINS]	163
24	3.17 ACCOUNT ALLOCATION [T2S.BPD.SETT.AALO].....	168
25	3.18 PLEDGING OF SECURITIES [T2S.BPD.SETT.PLED]	169
26	4. ASSET SERVICES PROCESSES.....	170
27	4.1 REPURCHASE AGREEMENTS [T2S.BPD.SETT.REPO]	170
28	4.2 ISSUANCE OF SECURITIES [T2S.BPD.SETT.ISSU]	176
29	4.3 SECURITIES LENDING AND BORROWING [T2S.BPD.SETT.LEND]	183
30	4.4 BACK-TO-BACK TRADES [T2S.BPD.SETT.BTOB]	188
31	4.5 BASKET TRADES [T2S.BPD.SETT.BASK]	191
32	4.6 COUPON STRIPPING [T2S.BPD.SETT.CSTR].....	194
33	4.7 COUPON RECONSTITUTION [T2S.BPD.SETT.CREC].....	198
34	4.8 BUY IN AND SELL OUT [T2S.BPD.SETT.BISO]	204

1	4.9	MARK-UP/ MARK-DOWN OF SECURITIES POSITIONS [T2S.BPD.SETT.MKUP].....	208
2	4.10	FUND SHARES SUBSCRIPTION [T2S.BPD.SETT.FNDS].....	209
3	4.11	ACCOUNT TRANSFER OF SECURITIES [T2S.BPD.SETT.ATRA]	217
4	5.	CORPORATE ACTIONS PROCESSES.....	218
5	5.1	DISTRIBUTIONS	218
6	5.2	REORGANISATIONS	234
7	5.3	TRANSACTION MANAGEMENT	252
8	6.	LIQUIDITY MANAGEMENT PROCESSES.....	279
9	6.1	TRANSFER OF LIQUIDITY FROM RTGS TO T2S [T2S.BPD.LQMG.INBD]	279
10	6.2	INTRADAY TRANSFER OF LIQUIDITY FROM T2S TO RTGS [T2S.BPD.LQMG.OTBD]	285
11	6.3	MULTIPLE LIQUIDITY PROVIDER TRANSFER OF LIQUIDITY FROM T2S TO RTGS [T2S.BPD.LQMG.MLPT]	293
12	6.4	TRANSFER OF LIQUIDITY WITHIN T2S [T2S.BPD.LQMG.INLT]	295
13	6.5	END OF DAY CASH MANAGEMENT [T2S.BPD.LQMG.EODC]	302
14	7.	STATIC DATA MAINTENANCE PROCESSES.....	311
15	7.1	MAINTENANCE OF SECURITIES [T2S.BPD.STDA.MSEC].....	311
16	7.2	MAINTENANCE OF SECURITIES ACCOUNT [T2S.BPD.STDA.MSAC]	318
17	7.3	MAINTENANCE OF CSD PARTICIPANT [T2S.BPD.STDA.MPTY]	327
18	7.4	MAINTENANCE OF PAYMENT BANK [T2S.BPD.STDA.MPBK]	332
19	7.5	MAINTENANCE OF DEDICATED CASH ACCOUNT [T2S.BPD.STDA.MDCA].....	337
20	7.6	MAINTENANCE OF EXTERNAL RTGS ACCOUNT [T2S.BPD.STDA.MRAC]	344
21	7.7	MAINTENANCE OF MESSAGE SUBSCRIPTION [T2S.BPD.STDA.MMSG]	348
22	7.8	MAINTENANCE OF REPORT SUBSCRIPTION [T2S.BPD.STDA.MREP]	351
23	7.9	MAINTENANCE OF ROLES [T2S.BPD.STDA.MROL].....	354
24	7.10	MAINTENANCE OF RESTRICTIONS [T2S.BPD.STD.MRES]	357
25	7.11	MAINTENANCE OF CoSD PARAMETERS [T2S.BPD.STDA.MCOS]	366
26	7.12	MAINTENANCE OF CROSS-CSD SETTLEMENT LINK AND SECURITIES ELIGIBILITY [T2S.BPD.STDA.MCSL]	
27		370	
28	7.13	MAINTENANCE OF MULTIPLE LIQUIDITY PROVIDERS [T2S.BPD.STDA.MMLP]	377
29	7.14	MAINTENANCE OF STANDING/PREDEFINES LIQUIDITY TRANSFER ORDERS [T2S.BPD.STDA.MLTO].....	381
30	7.15	MAINTENANCE OF AUTO-COLLATERALISATION ELIGIBILITY [T2S.BPD.STDA.MACE].....	387
31	7.16	MAINTENANCE OF MARKET SPECIFIC ATTRIBUTES [T2S.BPD.STD.MMSA].....	404
32	7.17	MAINTENANCE OF SYSTEM USER [T2S.BPD.STDA.MUSE]	410
33	7.18	MANAGEMENT OF LIMITS [T2S.BPD.STDA.MLIM]	414
34	8.	STATIC DATA RESTRICTION PROCESSES	419

1	8.1	(UN)BLOCKING OF SECURITIES [T2S.BPD.STDA.BSEC].....	419
2	8.2	(UN)BLOCKING OF SECURITIES ACCOUNT [T2S.BPD.STDA.BSAC].....	424
3	8.3	(UN)BLOCKING OF PARTY [T2S.BPD.SETT.BPRT]	430
4	8.4	(UN)BLOCKING OF T2S DEDICATED CASH ACCOUNTS [T2S.BPD.STDA.BDCA].....	435
5	8.5	(UN)BLOCKING OF RTGS ACCOUNT [T2S.BPD.STD.BRTG]	441
6	9.	REPORTING AND QUERIES.....	445
7	9.1	REPORTS [T2S.BPD.INFO.REPT]	445
8	9.2	QUERIES [T2S.BPD.INFO.QUIRE].....	448
9	10.	OPERATIONS AND SUPPORT PROCESSES	452
10	10.1	INVOICING OF CSDS AND CENTRAL BANKS [T2S.BPD.SUPP.INVO].....	452
11	10.2	ACCESS TO ARCHIVED DATA [T2S.BPD.SUPP.ARCH].....	456
12	10.3	APPROVAL OR REVOCATION OF REQUESTS SUBJECT TO THE FOUR-EYE-PRINCIPLE [T2S.BPD.SUPP.FEYE]	
13		459	
14	11.	APPENDICES.....	463
15	11.1	READING GUIDE TO THE BPD	463
16	11.2	INDEX OF PROCESSES	468
17	11.3	INDEX OF FIGURES	473
18	11.4	INDEX OF TABLES	476

1. INTRODUCTION

1.1 OBJECTIVE AND SCOPE

The Business Process Description (BPD) describes and illustrates the business processes involving CSDs, Central Banks and other technically directly connected parties and their interaction with T2S.

The aim of the BPD is:

- To provide the reader with a process-based perspective on the information presented in the User Detailed Functional Specification (UDFS), Graphical User Interface Business Functional Document (GUI BFD), and Service Description (SD) for the A2A and U2A interaction with T2S;
- To illustrate the use of T2S services in the context of parties' End-2-End business process;
- To demonstrate the use of T2S services for the processing of various transactions (e.g. corporate actions);
- To assist institutions in the feasibility study and adaptation analysis phases of their T2S projects; and
- To assist institutions in the documentation and/or adaptation of their internal processes including the T2S interaction.

The BPD provides information to:

- Process owners and business analysts (who own, analyse and document the business processes in their organisation);
- Operational groups (who manage and monitor the business processes);
- IT architects and developers (who implement the technology that will perform the business processes); and
- Organisations and individuals involved in the audit of the CSD, Central Bank and directly connected parties' processes.

Only T2S actors with a direct connection to T2S i.e. CSDs, Central Banks and their technically directly connected parties are depicted in the document.

Business processes are depicted on a generic level as the processes within each institution might differ. For this reason detailed descriptions of actors' internal business processes are not within the scope of this document. This document is thus to be understood as a generic document; the exact processing and services to be provided by CSDs, Central Banks and Directly Connected Parties is to be determined by the respective institutions and can therefore differ from the descriptions presented in this document.

1 Similarly, T2S internal processes are not depicted in detail but represented by the T2S services, in order to
2 avoid redundancies with T2S specification documents. However, references to the UDFS, GUI BFD and SD
3 are presented where applicable to enable the reader to quickly find the detailed description of the T2S
4 functionality in the relevant specifications and documentations.

5 The Business Processes are depicted from the perspective of one counterparty, i.e. the corresponding
6 activities undertaken by the other counterparty are not shown as they are the same.

7 The Business Process Diagrams and Descriptions are applicable for the whole business day, i.e. during real-
8 time and (night-time) batch settlement, unless otherwise noted.

9 As a general understanding of T2S functionality might be helpful for reading this document, the reading of
10 UDFS Chapters 1.1 and 1.6 is recommended prior to consulting the Business Process Description. Likewise,
11 for details on connectivity to T2S, the reading of UDFS Chapter 1.3 is recommended.

12 For details on the terms used throughout this document, refer to – unless otherwise noted – to the “Annex on
13 Glossary and Standards” in the T2S User Requirements Document.

14 **1.2 METHODOLOGY**

15 The description of each process is divided into the following four distinct sections to provide a visual as well
16 as a narrative representation of the process:

- 17 • Overview: summary of the business process including the possible process triggers, preconditions and
18 T2S instructing parties, i.e. parties that can possibly instruct T2S;
- 19 • Business Process Diagram: illustration of the business process using Business Process Model and
20 Notation (BPMN) conventions;
- 21 • Business Process Description: description of the activities depicted in the Business Process Diagram as
22 well as references to other relevant documents such as UDFS and GUI BFD.

23 **1.2.1 BUSINESS PROCESS DIAGRAM**

24 **1.2.1.1 SCOPE AND LIMITATIONS**

25 A *Business Process* can be defined as a series of activities conducted in order to accomplish a specific
26 objective.

27 Each Business Process is composed of process steps, so-called *activities* (refer to 1.2.1.2 Business Process
28 Modelling Notation). For the purpose of this document it can be distinguished between two types of
29 activities:

- 1 • Collaborative activities: process steps involving T2S interaction such as messages or data entry via the
2 GUI;
- 3 • Internal activities: all other process steps i.e. those not involving interaction with T2S. These activities
4 are depicted on a generic level only, as the exact processing needs to be determined by the respective
5 institution.

6 This document focuses on the collaborative activities, as internal activities will differ widely across the
7 different CSDs, Central Banks and their directly connected parties. Internal activities are displayed only to
8 indicate to the reader the context within its institution's end-to-end business process. For the creation of
9 institution-specific process documentation, each institution can enrich the business process individually with
10 more internal activities according to its target business process within its institution in order to depict the
11 complete end-to-end process.

12 Only parties with a direct connection to T2S are displayed. To give an example, CSD Participants who have
13 a direct connection (e.g. can receive messages) are displayed, those connected only via a CSD are not.
14 Similarly, Payment Banks indirectly connected to their Central Bank are not shown either.

15 Consequently only communication flows between T2S and its directly connected parties are shown.
16 Communication of CSDs and Central Banks with their clients (regardless of whether they are directly or
17 indirectly connected) is not described.

18 Details on technical connectivity are out of scope of this document.

19 All business processes are described independently of the settlement cycles in T2S. For details on the
20 schedule of the settlement day refer to the dedicated document online¹ or UDFS Chapter 1.4.

21 **1.2.1.2 BUSINESS PROCESS MODELLING NOTATION**



22 The design principles and graphical elements employed for the graphical depiction of Business Processes are
23 based on the Business Process Model and Notation (BPMN). BPMN was developed by the Object
24 Management Group (OMG) and is currently available in Version 2.0. The objective of BPMN is to “provide
25 a notation that is readily understandable by all business users, from the business analysts (...) to the technical
26 developers (...), and finally, to the business people who will manage and monitor those processes.”²





27 The following BPMN elements are used in this document:

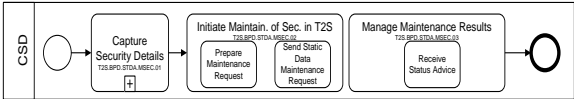

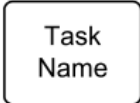
¹ http://www.ecb.europa.eu/paym/t2s/progress/pdf/extmtg/mtg16/schedule_clean.pdf?c760562e403dcf68789e2e5431db25f5

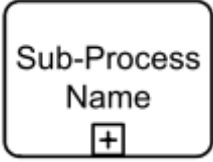
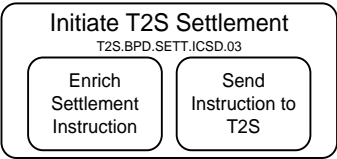
² Business Process Model and Notation, v.2.0, Object Management Group, <http://www.omg.org/spec/BPMN/2.0/>

1 **Table 1-1: BPMN elements**

<p style="text-align: center;">Pool:</p>  <p style="text-align: center;">Pool with activities:</p> 	<p>Pool</p> <p>A pool depicts an institutions i.e. it groups activities which are executed by one institution. This could be T2S parties such as CSDs, CSD Participants (with a direct connection to T2S), as well as Central Banks and Payment Banks (with a direct connection to T2S). T2S itself is also depicted as a pool.</p> <p>Those parties that instruct T2S directly within each respective process (e.g. by sending a message to T2S) are highlighted in bold. Other parties that are not directly involved in the process, but can receive information about the process (e.g. by receiving a notification message), are shown in normal font.</p>
	<p>Activity</p> <p>An activity is the generic term for work being performed as part of the business process.</p> <p>There are two types of activities:</p> <p>Task: An activity can depict a task i.e. an atomic unit of a process which cannot be divided any further</p> <p>Sub-process: An activity can be a sub-process that could be divided into several tasks.</p> <p>If an (internal) activity is optional this is indicated in the Business Process Description section.</p>
	<p>Task</p> <p>A Task is an activity which cannot be divided any further i.e. an atomic unit of a process.</p>

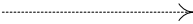
<p>Collapsed sub-process:</p>  <p>Expanded sub-process:</p> 	<p>Sub-process</p> <p>A sub-process is an activity which could be divided into several tasks.</p> <p>In this document, many activities are displayed as sub-processes, indicating that they can be divided into several tasks or that other tasks (such as post-processing or archiving) could be included in this step. For this document, only activities involving collaborative activities (e.g. the reception or transmission of a message) involving more than one known task are split into their tasks in the diagrams.</p> <p>The list of tasks depicted as part of a sub-processes is non-exhaustive and more tasks could be added according to the organisations' individual needs (e.g. further tasks for handling of specific messages or national specificities) or systems in use (e.g. if steps in multiple systems need to be conducted to conclude one activity or manual steps to be added).</p>
	<p>Group</p> <p>A Group is a loose combination of activities and serves as a means to categorise or highlight activities. Similarly, groups are used to indicate T2S services belonging together.</p>
<p>Start event:</p>  <p>End event:</p>  <p>Intermediate event:</p> 	<p>Event</p> <p>An event indicates something “happening” at the beginning/end or in the course of the process flow.</p> <p>There are three types of events:</p> <p>Start event: triggers a process</p> <p>End event: marks the end of a process</p> <p>Intermediate event: marks an intermediate step of a process e.g. when the process flow continues in another parties' pool.</p>

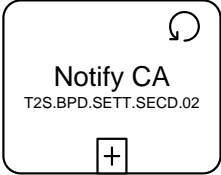
	<p>Sequence Flow</p> <p>A sequence flow indicates the order in which activities are performed.</p> <p>Some activities are not linked by sequence flows. This indicated that the first activity does not trigger the second activity, but that for example an incoming message is needed to trigger the remaining process flow.</p>
	<p>Message Flow</p> <p>A message flow shows the exchange of messages between T2S and its parties. The type of message flow (i.e. message or screen interaction) is indicated by the symbols for A2A or U2A interaction.</p>
	<p>Message/Application-to-application (A2A) interaction</p> <p>A message indicates objects which are exchanged in Application-to-Application (A2A) interaction between T2S and the parties (if directly connected) e.g. an ISO message. T2S Parties are required to have a Application-to-Application interface in order to receive these messages.</p> <p>Not every single message which could be exchanged is indicated. Messages are grouped (and illustrated by one symbol) into categories e.g. status advice messages, confirmation messages. As a result of the grouping, the BPD does not always reflect the sequence flow of message reception.</p>
	<p>User-to-Application (U2A) interaction</p> <p>User-to-Application interaction is marked by a different symbol, which indicates that interaction via the T2S GUI is possible.</p> <p>If interaction is possible using A2A as well as U2A, both symbols are shown.</p>
	<p>Recurring activity</p> <p>A recurring activity is an activity which is repeated until a specific event occurs. This event is indicated as a comment note.</p>

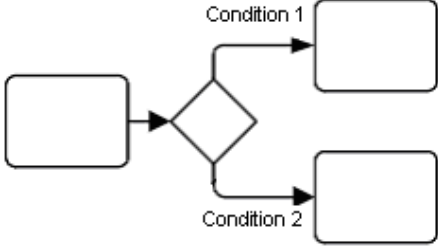
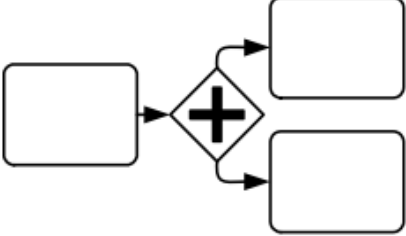
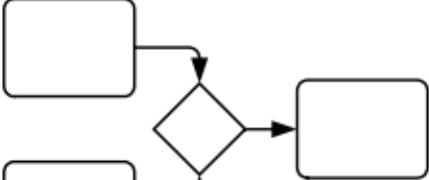
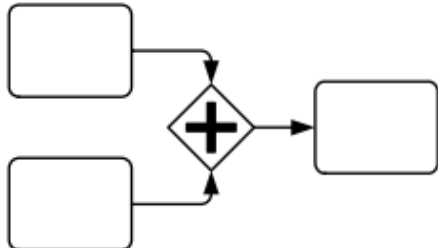
<p style="text-align: center;">Decision:</p>  <p style="text-align: center;">Fork:</p> 	<p>Decision and Fork/Splitting the process flow</p> <p>There are two options for splitting the process flow:</p> <p>Decision: A decision indicates that the process can follow either one of two alternative process flows (“OR”-connection).</p> <p>Fork: A fork indicates that the process will follow two process flows in parallel (“AND”-connection).</p>
<p style="text-align: center;">Merge:</p>  <p style="text-align: center;">Join:</p> 	<p>Merge and Join/Combining the process flow</p> <p>There are two options for combining the process flow:</p> <p>Merge: A merge indicates that two process flows are combined into one as soon as the first alternate process flow reaches the gateway (“OR”-connection).</p> <p>Join: A join indicates that two process flows are combined into one only if both process flows have reached the gateway (“AND”-connection).</p>

1 **1.2.2 BUSINESS PROCESS DESCRIPTION**

2 The Business Process Description section aims at detailing the activities (sub-processes and tasks) of the T2S
3 parties as well as the processing in T2S as illustrated in the respective Business Process Diagram.

4 **Reference IDs**

5 Reference ID are unique identifiers assigned to each process and activity (i.e. sub-process or task). The
6 naming scheme for the references is as follow:

7

1 *Sample:*
2 For processes:
3 T2S.BPD.SETT.ICSD – process type e.g. settlement process
4 T2S.BPD.SETT.ICSD – unique process reference
5 For sub-processes:
6 T2S.BPD.SETT.ICSD.01 – sub-process reference within a process
7 For tasks:
8 T2S.BPD.SETT.ICSD.01.01 – task reference within a sub-process

9 In the diagrams the reference IDs are included on a sub-process level.

10 **T2S Actors**

11 A *T2S Actor* is the entity that executes an activity e.g. a CSD. T2S Actors are indicated only on a sub-process
12 level, as the underlying tasks will have the same T2S Actor.

13 *Sample:*
14 T2S Actors: Payment Bank

15 **Messages to/from T2S**

16 The messages which are sent to or received from T2S are listed in a table along with a reference to UDFS
17 Chapter 3. T2S Parties need an Application-to-Application (A2A) interface in order to receive these
18 messages.

19 The set of messages displayed always indicates the entirety of messages that can be received by the T2S
20 Party, unless stated otherwise on the description. Whether a message is actually sent from T2S to the T2S
21 Party depends on the message subscription configuration for the T2S Party. All messages are subject to
22 message subscription.

23 **References to UDFS and GUI BFD**

24 Where applicable, references to the UDFS (v.1.2.1) and/or GUI BFD (v.1.7) are given.

25 *Sample:*
26 References:
27 UDFS: Use Case “Send Settlement Instruction” (Chapter 2.3)
28 GUI BFD: T2S.GUI.SESE.INX.0070

1 **Description of T2S Processes**

2 The sub-process “T2S Processing” (also: “Initial T2S Processing”) describes the relevant T2S services
3 involved in the respective business process, i.e. the services named in the respective Business Process
4 Description section.

5 The services listed here are confined to the following T2S Services Classes:

- 6 • Settlement Service Class
- 7 • Liquidity Management Service Class
- 8 • Static Data Service Class
- 9 • Information Management Service Class

10 Services belonging to the Connectivity Service Class and Operations and Support Service Class are not
11 described in this document, as details on technical connectivity are out of scope of this document and they
12 provide overarching functionalities that cannot be attributed to a specific business process. The same applies
13 to the Status Management Service and Message Subscription Service.

14 The specific use of a service within the context of the respective process is highlighted, whereas the general
15 service description is kept rather brief. In addition, references to the Service Description (SD) are included.

16 **1.2.3 T2S ACTORS**

17 In accordance with the definition of the term in the URD, *T2S Actor* is used for referring to any legal entity
18 that interacts directly or indirectly with T2S. The hierarchical model in T2S results in a clear differentiation
19 between the T2S Actors on the securities side (i.e. CSDs and CSD Participants) and on the cash side (i.e.
20 NCBs and Payment Banks). This document will use these terms to indicate the relevant role in which a legal
21 entity interacts with T2S. In this context it is important to keep in mind, that a single legal entity can fulfil
22 multiple roles even in a single scenario. For instance, a bank acting on the securities side as a CSD
23 Participant could at the same time also provide the necessary liquidity in its role as a Payment Bank holding
24 a cash account with its NCB. Although this bank is a single legal entity it would be configured in T2S as two
25 T2S Parties and fulfil two roles in the process.

26 The description of the T2S Actors involved for a certain business process follows the above categorisation,
27 i.e. CSD, CSD Participant, Central Bank and Payment Bank are used. In some cases additional information is
28 given in brackets (e.g. “Account Owner”) to better and clearly identify them.

29 The term “Instructing Party” is used to identify the T2S Actor that initiates a business process. This term is
30 used whenever a third party could instruct on behalf of another party, to clearly differentiate the information
31 that is provided as feedback to the Instructing Party and which information is provided to the other involved
32 T2S Actors on the securities and cash side. In all cases where the Instructing Party is identical with one of

1 the other T2S Actors in the business case, this T2S Actor will obviously receive the sum of communications
 2 mentioned for the Instructing Party and for its other role, but each of the listed messages will be sent only
 3 once, i.e. if a status notification is to be sent to the Instructing Party and to the CSD and the CSD is the
 4 Instructing Party, then T2S will send the status notification only once to the CSD.

5 **1.2.4 SCENARIOS**

6 A *scenario* is a possible configuration of T2S actors. Scenarios are used to describe alternative ways for a
 7 business process that mainly differ in the T2S actor that starts the process. For instance a hold instruction can
 8 be sent by a CSD (in this case the directly connected CSD Participant receives a copy of the message) or by
 9 the CSD Participant itself, provided he is directly connected to T2S (in this case the CSD receives a copy of
 10 the message). However, apart from these minor differences in the message flow, the business process is the
 11 same.

12 In the Business Process Diagram section scenarios are represented by means of alternative pool names. In
 13 order to follow one scenario the pool names have to be read along one of the two possible columns.

14 **Figure 1-1: Example of scenarios**

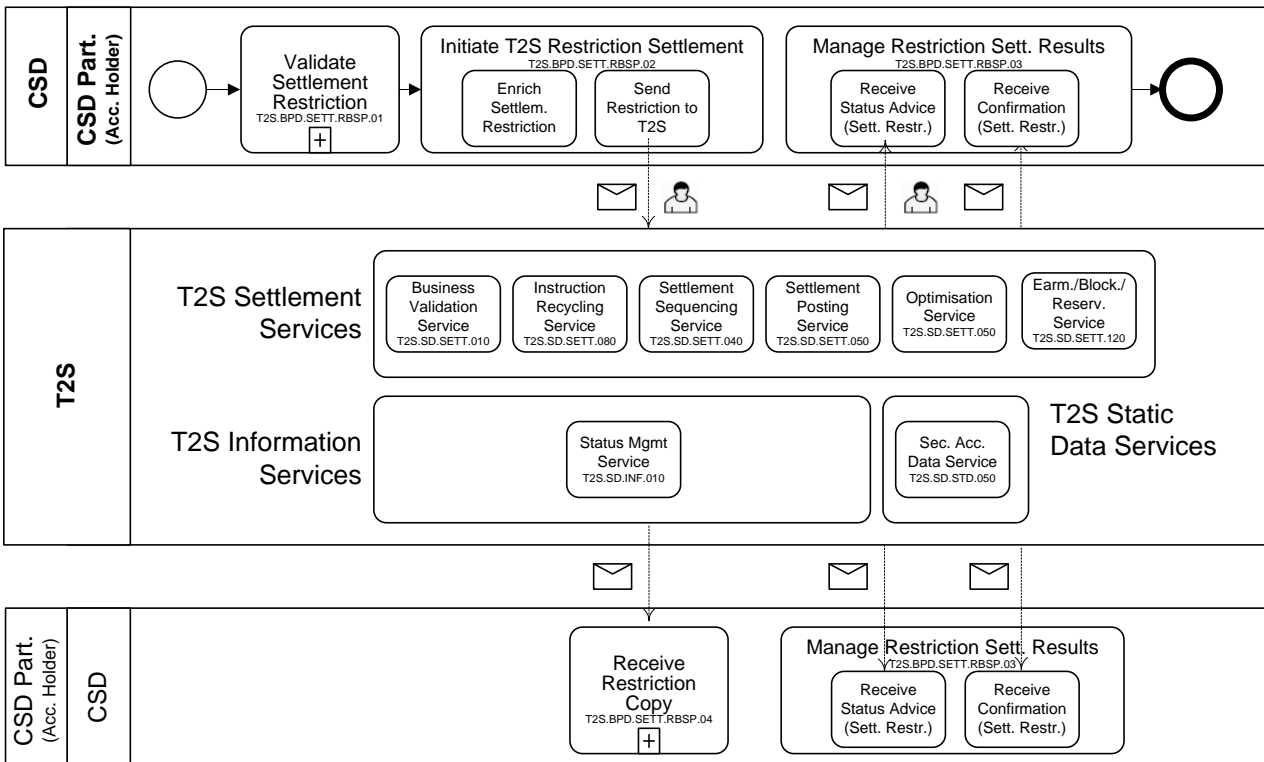

15
 16 In the example (Figure 1-1Figure 1-1), scenario A has the following configuration:

- 17
- The CSD instructs T2S (and might receive messages)
 - The CSD Participant receives messages
- 18

1 Scenario B can be read as follows:

- 2 • The CSD Participant instructs T2S (and might receive messages)
- 3 • The CSD receives messages

4 The Business Process Description section applies to Scenario A and B unless otherwise noted. For the
 5 purpose of readability, the actor names in the text refer to Scenario A with the Scenario B actor indicated in
 6 square brackets.

7 *Sample:*
 8 The CSD [CSD Participant] enriches the settlement instruction.

9 If a given activity can have different actors (depending on the scenario), both alternatives are listed under
 10 T2S actors.

11 *Sample:*
 12 T2S Actors: CSD (Scenario A)/CSD Participant (Scenario B)

13 For some activities the scenario is irrelevant i.e. the actors and their activities are the same regardless of the
 14 scenarios, for example when the CSD and CSD Participant both receive the same messages (in both
 15 scenarios). In this case no distinction between the scenarios is made

16 *Sample:*
 17 T2S Actors: CSD and CSD Participant (Both Scenarios)
 18 The CSD and CSD Participant receive status advice messages from T2S.

19 **1.2.5 VARIATIONS**

20 *Variations* of processes occur when two (or more) processes are very similar to one another, for instance if a
 21 process includes all activities of another process but adds one or more activities. In order to avoid repetitions
 22 and to point out differences and similarities between the processes these cases are displayed in a specific
 23 manner in this document.

24 For variations of one process the base process is referenced to and only deviations from this base process or
 25 specificities are pointed out and described.

26 **Table 1-2: BPMN elements for variations**

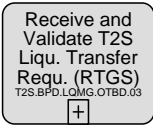
	<p>Activities which remain the same (as in the base process) are greyed out in the Business Process Diagram and not described again.</p>
---	--

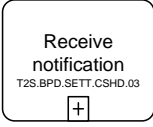
	<p>Activities which are not part of the variation (but of the base process) are greyed out and crossed out, indicating that they are not part of the process (even though they were in the base process).</p>
	<p>Activities that are either new in the variation or for which specificities (e.g. details for T2S instruction) are to be considered remain white in the Business Process Diagram and are described in the Business Process Description section under a new Reference ID.</p>

1 **Figure 1-2: Example of a variation**

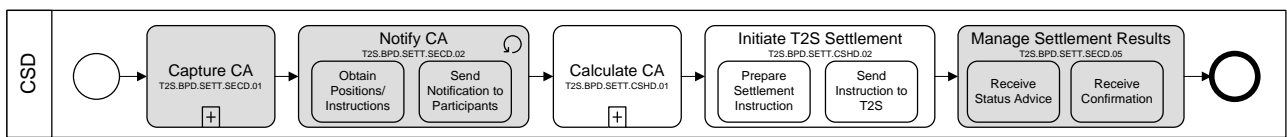

2
3 In the example (Figure 1-2) the activities which are greyed out do not differ from the base process. They are
4 not described again in the Business Process Description section of the variation; instead the original (base
5 process) reference ID is indicated for each greyed-out sub-process. The reference ID can be used to find the
6 corresponding description in the document. The activities which are white are described in the Business
7 Process Description section of the variation.

1 2. CORE SETTLEMENT PROCESSES

2 2.1.1 INTRA-CSD SETTLEMENT [T2S.BPD.SETT.ICSD]

3 2.1.2 OVERVIEW

4 This process describes the act of transferring of securities positions between the securities accounts of
5 participants belonging to same CSD. The parties involved in the trade or authorised third parties (e.g. central
6 counterparty “CCP” or a trading platform) may instruct T2S directly (if the CSD has granted them the
7 necessary privileges) or indirectly via the CSD.

8 **Trigger:**

- 9 • The CSD receives instructions from its CSD Participant or third parties (who are authorised by the CSD
10 Participant to instruct on behalf of the CSD Participant).
- 11 • The CSD Participant itself or third parties acting on behalf of the CSD Participant³ (e.g. acting as
12 account operators or custodians) receive instructions from their clients (e.g. end investors or financial
13 institutions).

14 **Preconditions:**

15 None

16 **T2S Instructing Party:**

17 There are two scenarios for the instruction of T2S:

- 18 • Scenario A: CSD instructs T2S.
- 19 • Scenario B: CSD Participant instructs T2S.

³ Example 1: A CCP acting as a CSD Participant receives details of trades executed on a stock exchange, performs trade validation and instructs T2S. Example 2: A stock exchanges (acting as a CSD Participant) may be authorised by the CSD Participants (i.e. owner of the securities accounts debited/credited in the securities settlement) to instruct on behalf of the CSD Participants.

1 **2.1.3 BUSINESS PROCESS DIAGRAM**

2 **Figure 2-1: Business Process Diagram [T2S.BPD.SETT.ICSD]**

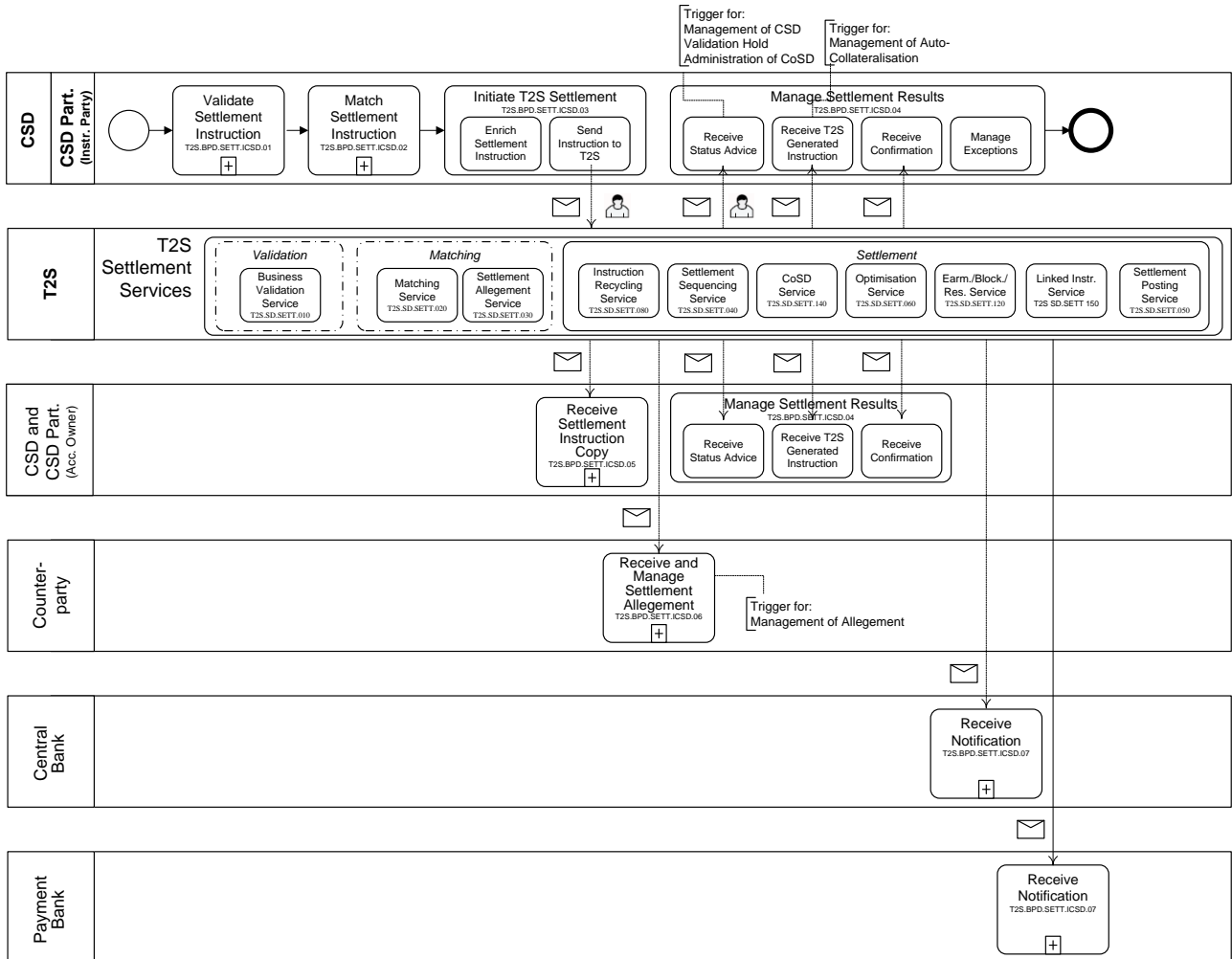

3

4 **2.1.4 BUSINESS PROCESS DESCRIPTION**

5 This Business Process Description is applicable to Scenario A and B unless otherwise noted. For the purpose
6 of readability, the actor names in the text refer to Scenario A with the Scenario B actor indicated in square
7 brackets.

8

1 **2.1.4.1 VALIDATE SETTLEMENT INSTRUCTION**

Reference ID	T2S.BPD.SETT.ICSD.01
--------------	----------------------

2 T2S Actors: CSD (Scenario A)/CSD Participant (Scenario B)

3 The CSD [CSD Participant] checks all the details in the settlement instruction against the reference data in its
 4 systems and may proceed to perform additional validations specific to the market practices or national
 5 regulations (if any)⁴.

6 **2.1.4.2 MATCH SETTLEMENT INSTRUCTION**

Reference ID	T2S.BPD.SETT.ICSD.02
--------------	----------------------

7 T2S Actors: CSD (Scenario A)/CSD Participant (Scenario B)

8 Based on the defined matching rules, the CSD [CSD Participant⁵] attempts to find a matching counterparty
 9 settlement instruction.

10 This process is an optional step⁶ and depends upon the type of instruction. This process is not required for
 11 settlement instructions already matched or the settlement instructions that do not require matching against a
 12 counterparty instruction due to local market practices. Also, some CSDs may discontinue their matching
 13 functionality and use T2S services for matching of settlement instructions.

14 **2.1.4.3 INITIATE T2S SETTLEMENT**

Reference ID	T2S.BPD.SETT.ICSD.03
--------------	----------------------

15 T2S Actors: CSD (Scenario A)/CSD Participant (Scenario B)

16 The CSD [CSD Participant] enriches the settlement instruction with details required for settlement
 17 processing in T2S and sends the settlement instruction to T2S.

18 References:

19 UDFS: Use Case “Send Settlement Instruction” (Chapter 2.3)

20 GUI BFD: T2S.GUI.SESE.INX.0070

⁴ The T2S restrictions framework also offers the option of setting up market specific processing validations. Refer to the process “Maintenance of Restrictions” for the description of set-up and maintenance of restrictions (to be included in v0.4).

⁵ A CSD Participant may attempt to match settlement instructions within its own system if both trading parties are its clients. In this case, the CSD Participant may send an already matched settlement instruction to T2S.

⁶ Not all CSD Participants (such as CCP and stock exchanges) perform this step. CCP and stock exchanges transform matched trade into T2S settlement instructions. However this is not limited to those types of actors. The ability to send already matched instructions in T2S is dependent on the CSD participant’s privileges to instruct both securities accounts mentioned in the already matched settlement instruction.

1 **2.1.4.3.1 Enrich Settlement Instruction**

Reference ID	T2S.BPD.SETT.ICSD.03.01
--------------	-------------------------

2 The CSD [CSD Participant] enriches the settlement instructions with T2S specific information such as T2S
 3 securities account number, T2S dedicated cash account number and delivery and receipt securities position
 4 types/cash balance types (e.g. deliver or receive into earmarked position type, deliver from a blocked or
 5 reserved securities position using specific restriction references). The CSD [CSD Participant] also populates
 6 other key parameters such as T2S process indicators (e.g. partial settlement indicator, hold/release indicator⁷,
 7 etc.) that influence the settlement processing in T2S, unless the default values are to be used for the
 8 instruction. The settlement instruction may be populated with other details to facilitate processes like tax
 9 processing, registration, etc that take place outside T2S.

10 **2.1.4.3.2 Send Settlement Instruction to T2S**

Reference ID	T2S.BPD.SETT.ICSD.03.02
--------------	-------------------------

11 The CSD [CSD Participant] converts the settlement instruction enriched with T2S specific information and
 12 T2S process indicators into the required message format and transmits it to T2S.

13 Settlement instructions that were successfully matched in the CSD [CSD Participant] system can be
 14 instructed as an “already matched instruction”. In all other cases a single instruction (i.e. only for one leg) is
 15 generated and sent to T2S.

16 The instruction of T2S is also possible via the T2S GUI.

17 The CSD [CSD Participant] sends the following message to T2S:

18 **Table 2-1: Messages to T2S [T2S.BPD.SETT.ICSD.03.02]**

Message Name	ISO Code	To/From T2S	UDFS Chapter
SecuritiesSettlementTransactionInstructionV03SecuritiesSettlementTransactionInstructionV03	Sese.023.001.03	To T2S	3.3.8.4

19 **2.1.4.4 T2S PROCESSING**

20 The **Business Validation Service (T2S.SD.SETT.010)** validates the incoming settlement instructions
 21 (SecuritiesSettlementTransactionInstructionV03) and verifies if the defined rules regarding the content of the
 22 message fields are fulfilled and sends out a status advice (SecuritiesSettlementTransactionStatusAdviceV03)

⁷ For details on holding a settlement instruction using a settlement instruction maintenance request refer to process “Hold of Settlement Instruction [T2S.BPD.SETT.HOLD]”.

1 with the result of the validation (i.e. “rejected” or “accepted”). If a market specific validation requires that
2 the settlement instruction is subject to a special hold / release procedure, an additional status advice
3 (SecuritiesSettlementConditionModificationStatusAdviceV02) is sent out.

4 Successfully validated, unmatched settlement instructions are processed by the **Matching Service**
5 **(T2S.SD.SETT.020)** to match the settlement instructions sent by the two parties (Buyer, Seller). This step is
6 skipped in case of already matched settlement instructions.

7 If the matching fails, the **Settlement Allegation Service (T2S.SD.SETT.030)** sends out allegation
8 messages (SecuritiesSettlementTransactionAllegationNotificationV02) to the Counterparty after a certain
9 delay.

10 All matched settlement instructions (successfully matched or already matched) are subject to the settlement
11 processing as soon as their intended settlement date is reached. After performing eligibility (e.g. intraday
12 restrictions and links with other instructions, etc.) and provision checks, the **Settlement Posting Service**
13 **(T2S.SD.SETT.050)** performs the actual settlement. Incomplete or unsuccessful settlement (i.e. “partially
14 settled”, “unsettled”) is communicated via status messages
15 (SecuritiesSettlementTransactionStatusAdviceV03). Final settlement is confirmed to the securities account
16 related T2S Parties (SecuritiesSettlementTransactionConfirmationV03) and also to the parties linked to the
17 cash accounts (BankToCustomerDebitCreditNotificationV02). In case the balance on a cash account after the
18 posting is below the floor or above the ceiling thresholds for this account, alert notifications
19 (ReturnAccountV05) are sent out to the related cash parties.

20 If restricted, blocked, or earmarked positions and/or balances are involved, the **Earmarking, Blocking and**
21 **Reservation Service (T2S.SD.SETT.120)** complements the Settlement Posting Service and might generate
22 additional messages corresponding to the status of internally generated intra-position or intra-balance
23 movements (IntraPositionMovementStatusAdviceV02, IntraBalanceMovementStatusAdviceV01,
24 IntraPositionMovementConfirmationV02, IntraBalanceMovementConfirmationV01). The **Optimisation**
25 **Service (T2S.SD.SEE.060)** supports the Settlement Posting Service in attempts to resolve the lack of
26 resources using auto-collateralisation. In such situations additional instructions might be generated and
27 related messages (SecuritiesSettlementTransactionGenerationNotificationV02) are sent out.

28 When T2S receives an instruction which is linked to one or more other instruction(s) or to a pool of
29 instructions, the **Linked Instructions Service (T2S SD.SETT 150)** validates these links and handles the
30 linkage throughout the settlement lifecycle according to the specified links.

31 All pending instructions that fail to settle during daytime settlement period are recycled by the **Instruction**
32 **Recycling Service (T2S.SD.SETT.080)**. After revalidation they are attempted again on the next settlement
33 day.

1 During night time settlement the **Settlement Sequencing Service (T2S.SD.SETT.040)** selects the eligible
 2 instructions for the individual settlement sequences.

3 If a matched settlement instruction fulfils the COSD rules on the intended settlement date the **Conditional**
 4 **Securities Delivery Service “COSD” (T2S.SD.SETT.140)** sends a status advice
 5 (SecuritiesSettlementTransactionStatusAdviceV03) to the involved parties. If the CoSD process requires
 6 securities and/or cash to be blocked, this service uses the Earmarking, Blocking and Reservation Service
 7 (T2S.SD.SETT.120) to perform the necessary intra-position and/or intra-balance movements.

8 **2.1.4.5 MANAGE SETTLEMENT RESULTS**

Reference ID	T2S.BPD.SETT.ICSD.04
--------------	----------------------

9 T2S Actors: CSD and CSD Participant (Both Scenarios)

10 The CSD and CSD Participant receive the settlement related messages from T2S and initiate related internal
 11 processes.

12 In both scenarios, the CSD and the CSD Participant receive the messages. When a CSD instructs T2S
 13 (Scenario A), the CSD Participant (if directly connected) can also receive these messages. Similarly, when
 14 the CSD Participant instructs T2S (Scenario B), the CSD can also receive the messages.

15 References:

16 UDFS: Use Case “Send Settlement Instruction” (Chapter 2.3)

17 **2.1.4.5.1 Receive Status Advice**

Reference ID	T2S.BPD.SETT.ICSD.04.01
--------------	-------------------------

18 The CSD and CSD Participant receive status advice messages for every status change or reason code updates
 19 to the settlement instruction within T2S (see below for non-exhaustive list of examples of status change or
 20 reason code update).

- 21 • Change of settlement instruction status may be due to rejection of settlement instruction (due to
 22 revalidation), matching of settlement instruction, cancellation of settlement instruction by T2S due to
 23 revalidation or instruction remaining unmatched for 20 business days in T2S, etc.
- 24 • Change of reason code may be due to insufficient securities positions or cash balances, blocked party,
 25 blocked ISIN, blocked securities accounts, blocked T2S dedicated cash account, etc.

26 If T2S has been instructed via the T2S GUI the status is shown on the screen and status advice message are
 27 sent to the CSD and CSD Participant.

1 In addition to the status updates on the settlement instruction sent by the CSD [CSD Participant], the CSD
2 and CSD Participant also receive other updates described below, triggered by T2S internal validations and
3 processing:

- 4 • Conditional Securities Delivery (also called CoSD) process allows the CSD to handle exceptions
5 wherein the securities settlement is allowed to take place in T2S upon fulfilment of a settlement
6 condition outside T2S only. T2S validates the settlement instruction for CoSD process on or after the
7 intended settlement date of the settlement instruction. For example, free of payment settlement in T2S
8 can be coordinated with cash settlement (e.g. in non-T2S settlement currency) outside T2S using the
9 CoSD functionality.

10 For details on CoSD processing, refer to process “Administration of CoSD [T2S.BPD.SETT.COSD]”.

- 11 • Restrictions functionality allows the CSD to set-up additional validations related to market specific
12 processing in T2S. These validations may result in the settlement instruction either rejected or put on
13 CSD Validation Hold.

- 14 ○ CSD Validation Hold functionality allows the CSD to set-up predefined conditions and
15 automatically hold settlement instructions for additional validation or processing by the
16 CSD. The CSD releases the instructions for settlement in T2S once the validations or
17 additional processes have been completed. For details on processing of CSD Validation
18 Hold, refer to process “Management of CSD Validation Hold [T2S.BPD.SETT.CSDH]”.

- 19 ○ Rejection functionality allows the CSD to set-up predefined conditions and reject the
20 settlement instructions.

- 21 • Realignment functionality automatically realigns the positions of the Investor CSDs, other Investor
22 CSDs and/or the Issuer CSD. The realignments are based on the information set in the static data of T2S
23 by the CSDs. T2S analyses the CSDs involved in a settlement and automatically creates additional
24 settlement instructions to realign the books of all intermediating CSDs. The settlement instructions for
25 realignments are created irrespective of the intended settlement date (i.e. before, after or on the intended
26 settlement date). For intra-CSD settlements such realignment instructions are only generated if the
27 Investor CSD has set-up distinct omnibus accounts in the Technical Issuer CSD for the participant
28 accounts involved.

- 29 • Auto-collateralisation functionality allows the central banks/Payment Banks to offer collateralised
30 intraday credit to payments banks (i.e. central bank acting as credit provider)/client of Payment Banks
31 (i.e. Payment Bank acting as credit provider) using either the securities being purchased or held in the
32 securities account. For details on processing of auto-collateralisation notifications, refer to process
33 “Management of Auto-Collateralisation [T2S.BPD.SETT.ACOL]”.

- 1 • Pre-emption functionality allows complementing a pending intra-position / intra-balance movements for
2 reservation with any incoming securities / cash proceeds provided these securities or cash proceeds are
3 not to be used for any other purpose
- 4 • Securities accounts “On Hold” functionality allows a settlement instruction on the respective securities
5 account to be put on party hold as soon as the settlement instruction is received in T2S.
- 6 For Restrictions processing (CSD specific validations), the CSD and CSD Participant receive a status advice
7 with a generic rejection code for the settlement instruction indicating that the settlement instruction was
8 rejected.
- 9 For Realignments processing, the CSD and CSD Participant receive T2S generated settlement instructions on
10 mirror and omnibus accounts. In certain scenarios of intra-CSD settlement when the participant accounts in
11 the CSD are mapped to different omnibus accounts in the Technical Issuer CSD, T2S determines and
12 generates settlement instructions for realigning the securities positions in the omnibus and mirror accounts.
- 13 For Pre-emption processing, the CSD and CSD Participant receive a status advice for a pending settlement
14 instruction that may settle partially as a result of incoming resources (partial settlement – unsettled part).
- 15 For Securities Accounts “On Hold” processing, the CSD and CSD Participant receive a status advice
16 specifying that the settlement instruction is put on “Party Hold”.
- 17 Note: In case the hold/release indicator is set “Yes” in the incoming settlement instruction, the CSD and
18 CSD Participant will receive a status advice specifying that the instruction is put on “CSD Hold” or “Party
19 Hold”.
- 20 For revalidation of settlement instructions (due to change of static data or start of day revalidations), the CSD
21 and CSD Participant receive a status advice specifying that the settlement instruction has been cancelled as a
22 result of revalidation.

23

1 The CSD and CSD Participant receive the following messages from T2S:

2 **Table 2-2: Messages from T2S [T2S.BPD.SETT.ICSD.04.01]**

Message Name	ISO Code	To/From T2S	Event	UDFS Chapter	Exception Handling
SecuritiesSettlementTransactionStatusAdviceV03	Sese.024.001.0303	From T2S	Change in status of settlement instruction	3.3.8.5	This message will also be used to inform about rejection, cancellation and reason codes updates (e.g. insufficient positions, cash balances, blocking of party, etc)
SecuritiesSettlementConditionModificationStatusAdviceV03	Sese.031.001.03	From T2S	Settlement instruction is subject to CoSD Hold	3.3.8.11	

3 Following the message reception, other internal activities might be conducted such as:

- 4
- 5 • aligning the status of the settlement instruction in the CSD or CSD Participant’s systems with the status in T2S,
 - 6 • exception management,
 - 7 • amending the settlement instruction,
 - 8 • sending additional settlement instructions (e.g. in case of external CSD settlements),
 - 9 • triggering notification to CSD Participants.

10 **2.1.4.5.2 Receive T2S Generated Instruction**

Reference ID	T2S.BPD.SETT.ICSD.04.02
--------------	-------------------------

11 The CSD and CSD Participant receive the notifications for T2S generated instructions (except for T2S
 12 generated settlement restrictions). T2S may generate additional instructions due to various T2S processes
 13 triggered by the settlement instruction.

14 For details on management of auto-collateralisation, refer to process “Management of auto-collateralisation
 15 [T2S.BPD.SETT.ACOL]”.

1 **Table 2-3: Mapping of T2S Generated Instruction and T2S Processes [T2S.BPD.SETT.ICSD.04.02]**

No.	T2S Generated Instructions	T2S Processes
1	Settlement Instructions	Realignments in case the participant accounts are mapped to two different omnibus accounts in the technical Issuer CSD Auto-collateralisation and Reverse Auto-collateralisation
2	Settlement Restrictions (informed via Intra-position or Intra-balance ⁸ movement status advice or settlement confirmations)	Use of blocked or reserved securities or cash in the settlement instruction Auto-collateralisation and Reverse Auto-collateralisation

2 The CSD and CSD Participant receive the following messages from T2S:

3 **Table 2-4: Messages from T2S [T2S.BPD.SETT.ICSD.04.02]**

Message Name	ISO Code	To/From T2S	Event	UDFS Chapter
SecuritiesSettlementTransactionGenerationNotificationV03	Sese.032.001.03	From T2S	Generation of settlement instructions by T2S due realignments.	3.3.8.12

4 **2.1.4.5.3 Receive Settlement Confirmation**

Reference ID	T2S.BPD.SETT.ICSD.04.03
--------------	-------------------------

5 The CSD and CSD Participant receive and validate settlement confirmation messages for the settlement
6 instructions sent to T2S and the T2S generated settlement instructions. The settlement instructions may settle
7 partially or fully depending upon the availability of resources. In addition, settlement confirmations may also
8 be received for partial and full settlement of settlement restriction (i.e. pending settlement restrictions for the
9 purpose of reserving securities positions or cash amounts that settle due to pre-emption of incoming
10 resources).

11 Following the message reception, other internal activities might be conducted such as:

- 12 • aligning the status of the settlement instruction in the CSD’s or CSD Participant’s books with the status
13 in T2S,
- 14 • sending additional settlement instructions,
- 15 • triggering notification to CSD Participants,

⁸ T2S sends an intra-balance movement status advice primarily to the Payment Bank owning the DCA and to other parties that have subscribed to the status advice message.

- 1 • performing the registration of securities,
 - 2 • tax processing,
 - 3 • regulatory reporting.
- 4 The CSD and CSD Participant receive the following messages from T2S:

5 **Table 2-5: Messages from T2S [T2S.BPD.SETT.ICSD.04.03]**

Message Name	ISO Code	To/From T2S	Event	UDFS Chapter
SecuritiesSettlementTransactionConfirmationV03	Sese.025.001.03	From T2S	Partial or Full settlement of the settlement instruction sent by T2S actor and realignment instructions	3.3.8.6
IntraPositionMovementConfirmationV03	Semt.015.001.03	From T2S	1. Blocked or reserved securities have been used for settlement of the settlement instruction 2. Reservation of securities positions as a result of pre-emption of incoming resources	3.3.7.4
IntraBalanceMovementConfirmationV01	Camt.068.001.01	From T2S	1. Use of blocked or reserved cash for settlement of a settlement instruction 2. Reservation of cash as a result of pre-emption of incoming resources	3.3.3.22

6 **2.1.4.5.4 Manage Exceptions**

Reference ID	T2S.BPD.SETT.ICSD.04.04
--------------	-------------------------

- 7 The CSD [CSD Participant] perform additional activities to manage exceptions as communicated by T2S
- 8 using status advice messages.
- 9 The CSD and the CSD Participant must analyse the status advice messages to determine which status
- 10 changes or reason code updates require additional action to be taken by CSD or CSD Participants (like

1 arrange for securities positions or cash balances in case of insufficient resources, rejection of settlement
 2 instruction or cancellation of settlement instruction by T2S), whereas others may be purely informational and
 3 do not require any action to be taken (like receiving a status advices with reason code specifying instruction
 4 on COSD Hold or instructing awaiting release from Administering Party).

5 **2.1.4.6 RECEIVE SETTLEMENT INSTRUCTION COPY**

Reference ID	T2S.BPD.SETT.ICSD.05
--------------	----------------------

6 T2S Actors: CSD Participant (Scenario A)/CSD (Scenario B)

7 The CSD Participant [CSD] receives the copy of settlement instruction initiated by the CSD on securities
 8 account owned by the CSD Participant.

9 The CSD Participant [CSD] stores the copy of the settlement instruction and references the same upon
 10 receipt of status updates and confirmations from T2S.

11 The CSD Participant [CSD] receives the following messages from T2S:

12 **Table 2-6: Messages from T2S [T2S.BPD.SETT.ICSD.05]**

Message Name	ISO Code	To/From T2S	Event	UDFS Chapter
SecuritiesSettlementTransactionInstructionV03	Sese.023.001.03	From T2S	Successful validation of the Settlement Instruction sent by the CSD	3.3.8.4

13 **2.1.4.7 RECEIVE AND MANAGE SETTLEMENT ALLEGEMENTS**

Reference ID	T2S.BPD.SETT.ICSD.06
--------------	----------------------

14 T2S Actors: Counterparty [CSD / CSD Participant]

15 The Counterparty receives a Settlement Allegement and may conduct additional tasks related to management
 16 of allegements.

17 For details on management of allegements, refer to process “Management of Allegement
 18 [T2S.BPD.SETT.ALEG]”.

19

1 The Counterparty receives the following message from T2S:

2 **Table 2-7: Messages from T2S [T2S.BPD.SETT.ICSD.06]**

Message Name	ISO Code	To/From T2S	Event	UDFS Chapter
SecuritiesSettlementTransactionAllegationNotificationV03	Sese.028.001.03	From T2S	No matching counterparty instruction exists	3.3.8.8

3 **2.1.4.8 RECEIVE NOTIFICATIONS**

Reference ID	T2S.BPD.SETT.ICSD.07
--------------	----------------------

4 T2S Actors: Payment Bank and Central Bank (Both scenarios)

5 The Payment Bank and Central Bank receive a notification whenever a securities settlement instruction
 6 results in the debit or credit of one of their T2S dedicated cash accounts. If the cash posting has caused the
 7 T2S dedicated cash account to be lower than the floor or higher than the ceiling thresholds T2S sends a
 8 second notification message.

9 The Payment Bank and Central Bank may conduct additional tasks such as updating cash registers of the
 10 Payment Bank/Central Bank and liquidity management activities (e.g. resulting in a transfer of cash from or
 11 to T2S).

12 The Payment Bank and Central Bank receive the following messages from T2S:

13 **Table 2-8: Messages from T2S [T2S.BPD.SETT.ICSD.07]**

Message Name	ISO Code	To/From T2S	Event	UDFS Chapter
BankToCustomerDebitCreditNotificationV03	Camt.054.001.03	From T2S	Debit or Credit on T2S dedicated cash account	3.3.3.17
ReturnAccountV05	Camt.004.001.05	From T2S	Cash balance after the posting on the dedicated cash account is below the floor or above the ceiling thresholds set-up for the dedicated cash account	3.3.3.2

14

1 2.2 CROSS-CSD SETTLEMENT (WITH CSD INSIDE T2S) 2 [T2S.BPD.SETT.CCSD]

3 2.2.1 OVERVIEW

4 This process describes the act of transferring securities positions between securities accounts of participants
5 belonging to two different CSDs. The CSDs of the buyer and seller are in T2S and linked to each other via
6 either a direct CSD links or an indirect CSD links using a chain of intermediating CSDs. The CSD links are
7 set in T2S static data.

8 In case the counterparty CSDs have a direct link, one CSD holds one or more omnibus accounts in the other
9 CSD, the so called technical issuer. However, in case the counterparty CSDs use relayed link, then there
10 must exist at least one other technical Issuer CSD (i.e. a CSD servicing omnibus accounts for other CSDs in
11 the chain). The cross-CSD settlement in both cases involves a realignment of the mirror and omnibus
12 securities accounts across the entire chain of CSDs linking the counterparty CSDs.

13 The parties involved in the trade may instruct T2S directly, indirectly via the CSD or authorise a third party
14 (e.g. central counterparty “CCP” or trading platform) to instruct on their behalf.

15 For examples of bookings on accounts in a cross-CSD scenario, refer to UDFS Chapter 1.6.1.10
16 “Realignment”.

17 **Trigger:**

- 18 • The CSD receives instructions from its CSD Participants or third parties authorised by the CSD
19 Participant to instruct on its behalf.
- 20 • The CSD Participant itself or third parties acting on behalf of the CSD Participant⁹ (e.g. acting as
21 account operators or custodians) receive instructions from their clients (e.g. end investors or financial
22 institutions).

23 **Preconditions:**

24 Before the start of a cross CSD settlement in T2S, each CSD must have completed the set-up of cross CSD
25 links with other CSD in T2S, as specified below.

- 26 • Security CSD links – specifies for a CSD the eligibility of a security for settlement and the technical
27 Issuer CSD for the security.

⁹ Example 1: A CCP acting as a CSD Participant receives details of trades executed on a stock exchange, performs trade validation and instructs T2S. Example 2: A stock exchange (acting as a CSD Participant) may be authorised by the CSD Participants (i.e. owner of the securities accounts debited/credited in the securities settlement) to instruct on behalf of the CSD Participants.

- 1 • CSD Account links – specifies (depending on the participant account, if needed) the mirror¹⁰, inter-
2 CSD¹¹ and omnibus accounts between an investor CSD and its technical Issuer CSD.
- 3 • Eligible Counterpart CSD – specifies that two CSDs allow settlement of a specific security or set of
4 securities between each other.

T2S Instructing Parties:

There are two scenarios for the instruction of T2S:

- 7 • Scenario A: CSD instructs T2S.
- 8 • Scenario B: CSD Participant instructs T2S.

2.2.2 BUSINESS PROCESS DIAGRAM

10 **Figure 2-2: Business Process Diagram [T2S.BPD.SETT.CCSD]**

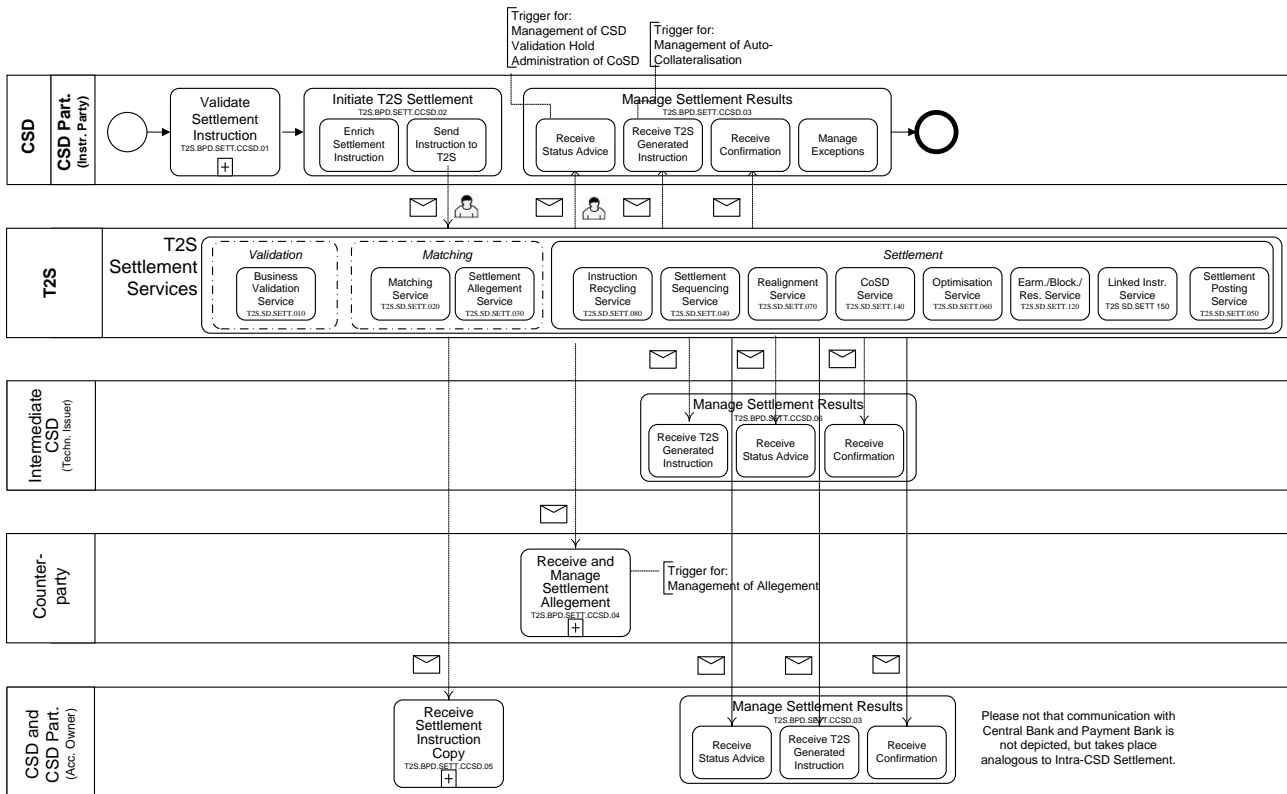

11

¹⁰ A *Mirror account* is opened by an Investor CSD in its books to represent its holdings on the Investor CSD’s Omnibus account in Technical Issuer CSD. An *Omnibus* account is opened by an Investor CSD in its Technical Issuer CSD to hold the securities owned by its participants. The omnibus account is equivalent to any other account in the Technical Issuer CSD (for details, see UDFS section 1.2.6.6)

¹¹ An *Inter-CSD account* is opened by Investor CSD in its books and used in transactions wherein the Issuer CSD is external to T2S. This account is not a mandatory attribute in a *CSD Account Link* business object and is required only in case of external CSD scenario.

1 **2.2.3 BUSINESS PROCESS DESCRIPTION**

2 This Business Process Description is applicable to Scenario A and B unless otherwise noted. For the purpose
 3 of readability, the actor names in the text refer to Scenario A with the Scenario B actor indicated in square
 4 brackets.

5 **2.2.3.1 VALIDATE SETTLEMENT INSTRUCTION**

Reference ID	T2S.BPD.SETT.CCSD.01
--------------	----------------------

6 T2S Actors: CSD (Scenario A)/CSD Participant (Scenario B)

7 The CSD [CSD Participant] checks all the details in the settlement instruction against their internal reference
 8 data (maintained by the CSD or CSD Participant) and may perform additional validations specific to their
 9 market practices or national regulations (if any)¹². The CSD [CSD Participant] may also perform validations
 10 regarding securities settlement with the counterparty’s CSD.

11 It is not possible to send already matched instructions, if the two legs of the settlement instruction belong to
 12 two different CSDs.

13 **2.2.3.2 INITIATE T2S SETTLEMENT**

Reference ID	T2S.BPD.SETT.CCSD.02
--------------	----------------------

14 T2S Actors: CSD (Scenario A)/CSD Participant (Scenario B)

15 The CSD [CSD Participant] enriches the settlement instruction with details required for settlement
 16 processing in T2S and sends the settlement instruction to T2S.

17 References:

18 UDFS: Use Case “Send Settlement Instruction” (Chapter 2.3)

19 GUI BFD: T2S.GUI.SESE.INX.0070

20 **2.2.3.2.1 Enrich Settlement Instruction**

Reference ID	T2S.BPD.SETT.CCSD.02.01
--------------	-------------------------

21 The CSD [CSD Participant] enriches the settlement instructions with T2S specific information such as T2S
 22 securities account number, T2S dedicated cash account number and delivery and receipt securities position
 23 types/cash balance types (e.g. deliver or receive into earmarked position type, deliver from a blocked or

¹² The T2S restrictions framework also offers the option of setting up market specific processing validations. Refer to the BPD for “Maintain Restrictions” for the description of set-up and maintenance of restrictions.

1 reserved securities position using the specific restriction references). The CSD [CSD Participant] also
 2 populates other key parameters such as T2S process indicators (e.g. partial settlement indicator, hold/release
 3 indicator¹³, etc.) that influence the settlement processing in T2S, unless the default values are to be used for
 4 the instruction.

5 **2.2.3.2.2 Send Instruction to T2S**

Reference ID	T2S.BPD.SETT.CCSD.02.02
--------------	-------------------------

6 The CSD [CSD Participant] converts the settlement instruction enriched with T2S specific information and
 7 T2S process indicators into the required message format and transmits it to T2S. The processing of
 8 settlement instruction in T2S depends on the specified values of the T2S process indicators in the settlement
 9 instruction.

10 The instruction of T2S is also possible via the T2S GUI.

11 The CSD [CSD Participant] sends the following message to T2S:

12 **Table 2-9: Messages to T2S [T2S.BPD.SETT.CCSD.02.02]**

Message Name	ISO Code	To/From T2S	UDFS Chapter
SecuritiesSettlementTransactionInstructionV03	Sese.023.001.03	To T2S	3.3.8.4

13 **2.2.3.3 T2S PROCESSING**

14 The cross CSD settlements process involves the **Realignment Service (T2S.SD.SETT.040)**. The
 15 Realignment Service analyses the matched settlement instructions and T2S static data to identify the need for
 16 cross CSD settlement. The service determines the chain of intermediating CSDs between the buying and
 17 selling CSD and generates the necessary realignment instructions for realigning the CSD technical accounts
 18 (e.g. mirror account) and informs the involved CSDs
 19 (SecuritiesSettlementTransactionGenerationNotificationV02).

20 For details on the remaining services involved, refer to process “Intra-CSD Settlement
 21 [T2S.BPD.SETT.ICSD]”.

22 For examples of bookings on accounts in a cross-CSD scenario, refer to UDFS Chapter 1.6.1.10
 23 “Realignment”.

¹³ For details on holding a settlement instruction using a settlement instruction maintenance request refer to process “Hold of Settlement Instruction [T2S.BPD.SETT.HOLD]”.

1 **2.2.3.4 MANAGE SETTLEMENT RESULTS**

Reference ID	T2S.BPD.SETT.CCSD.03
--------------	----------------------

2 T2S Actors: CSD and CSD Participant (both scenarios)

3 The CSD and CSD Participant receive the settlement related messages from T2S and initiate related internal
4 processes.

5 In both scenarios, the CSD and the CSD Participant receive the messages. When a CSD instructs T2S
6 (Scenario A), the CSD Participant (if directly connected) can also receive these messages. Similarly, when
7 the CSD Participant instructs T2S (Scenario B), the CSD can also receive the messages.

8 References:

9 UDFS: Use Case “Send Settlement Instruction” (Chapter 2.3)

10 **2.2.3.4.1 Receive Status Advice**

Reference ID	T2S.BPD.SETT.CCSD.03.01
--------------	-------------------------

11 The CSD and CSD Participant receive status advice messages sent by T2S to indicate a status change or
12 reason code update for the settlement instruction within T2S.

13 If T2S has been instructed via the T2S GUI, the status is shown on the screen and status advice message are
14 sent to the CSD and CSD Participant.

15 In addition to the status updates on the settlement instruction sent by the CSD [CSD Participant], the CSD
16 and CSD Participant also receive other updates described below.

17 For Conditional Securities Delivery (CoSD) processing, refer to process “Administration of CoSD
18 [T2S.BPD.SETT.COSD]”.

19 For CSD Validation Hold processing, refer to process “Management of CSD Validation Hold
20 [T2S.BPD.SETT.CSDH]”.

21 For Auto-Collateralisation processing, refer to process “Management of Auto-Collateralisation
22 [T2S.BPD.SETT.ACOL]”.

23 For Realignments processing, the CSD receives a status advice for T2S generated settlement instructions.

24 For Restriction Rejection processing (CSD specific validations), the CSD and CSD Participant receive a
25 status advice with a generic rejection code for the settlement instruction indicating that the settlement
26 instruction was rejected.

1 For Pre-emption processing, the CSD and CSD Participant receive a status advice for a pending settlement
 2 instruction that may settle partially as a result of incoming resources (partial settlement – unsettled part).

3 For Securities Accounts “On Hold” processing, the CSD and CSD Participant receive a status advice
 4 specifying that the settlement instruction is put on “Party Hold”.

5 In case of cross-CSD settlements, settlement instructions from a CSD are subjected to the restriction and
 6 CoSD rules set-up in T2S by that CSD only (and not those of other CSDs involved in the cross-CSD
 7 settlement). All settlement instructions (i.e. business and realignment instructions) are subject to rejection
 8 and CoSD rules set-up by their respective CSDs.

9 Following the message reception, other internal activities might be conducted such as:

- 10 • aligning the status of the settlement instruction in the CSD’s or CSD Participant’s systems with the status
 11 in T2S,
- 12 • exception management,
- 13 • amending the settlement instruction,
- 14 • sending additional settlement instructions,
- 15 • triggering notification to CSD Participants.

16 The CSD and CSD Participant receive the following messages from T2S:

17 **Table 2-10: Messages from T2S [T2S.BPD.SETT.CCSD.03.01]**

Message Name	ISO Code	To/From T2S	Event	UDFS Chapter	Exception Handling
SecuritiesSettlementTransactionStatusAdviceV03	Sese.024.001.0303	From T2S	Change in status of settlement instruction	3.3.8.4	This message will also be used to inform about rejection, cancellation and reason codes updates (e.g. insufficient positions, cash balances, blocking of party, etc)
SecuritiesSettlementConditionModificationStatusAdviceV03	Sese.031.001.03	From T2S	Settlement instruction is subject to CoSD Hold	3.3.8.11	

18

1 **2.2.3.4.2 Receive T2S Generated Instruction**

Reference ID	T2S.BPD.SETT.CCSD.03.02
--------------	-------------------------

2 The CSD and CSD Participant receive the messages for T2S generated instructions. T2S may generate
3 additional instructions due to various T2S processes triggered by the first settlement instruction.

4 For details on management of auto-collateralisation, refer to process “Management of auto-collateralisation
5 [T2S.BPD.SETT.ACOL]”.

6 **Table 2-11: Mapping of T2S Generated Instruction and T2S Processes [T2S.BPD.SETT.CCSD.03.02]**

No:	T2S Generated Instructions	T2S Processes
1	Settlement Instructions	Realignments in cross CSD settlements scenarios. The realignment messages are only received by the CSD. Auto-collateralisation and Reverse Auto-collateralisation
2	Settlement Restrictions (informed via Intra-position or Intra-balance movement status advice)	Use of blocked or reserved securities or cash in the settlement instruction Auto-collateralisation and Reverse Auto-collateralisation

7 The CSD and CSD Participant receive the following messages from T2S:

8 **Table 2-12: Messages from T2S [T2S.BPD.SETT.CCSD.03.02]**

Message Name	ISO Code	To/From T2S	Event	UDFS Chapter
SecuritiesSettlementTransactionGenerationNotificationV03	Sese.032.001.03	From T2S	Generation of settlement instructions by T2S due to Realignments	3.3.8.12

9 **2.2.3.4.3 Receive Settlement Confirmation**

Reference ID	T2S.BPD.SETT.CCSD.03.03
--------------	-------------------------

10 The CSD and CSD Participant receive and validate settlement confirmation messages for the settlement
11 instructions sent to T2S and the T2S generated settlement instructions.

12 Following the message reception, other internal activities might be conducted such as:

- 13 • aligning the status of the settlement instruction in the CSD’s or CSD Participant’s books with the status
14 in T2S,

- 1 • sending additional settlement instructions,
 - 2 • triggering notification to CSD Participants,
 - 3 • performing the registration of securities.
- 4 The CSD and CSD Participant receive the following messages from T2S:

5 **Table 2-13: Messages from T2S [T2S.BPD.SETT.CCSD.03.03]**

Message Name	ISO Code	To/From T2S	Event	UDFS Chapter
SecuritiesSettlementTransactionConfirmationV03	Sese.025.001.03	From T2S	Partial or Full settlement of the settlement instruction	3.3.8.6
IntraPositionMovementConfirmation	Semt.015.001.03	From T2S	1. Blocked or reserved securities have been used for settlement of the settlement instruction. 2. Reservation of securities positions as a result of pre-emption of incoming resources	3.3.7.4
IntraBalanceMovementConfirmationV01	Camt.068.001.01	From T2S	1. Use of blocked or reserved cash for settlement of a settlement instruction 2. Reservation of cash as a result of pre-emption of incoming resources	3.3.3.22

6 **2.2.3.4.4 Manage Exceptions**

Reference ID	T2S.BPD.SETT.CCSD.03.04
--------------	-------------------------

7 The CSD [CSD Participant] perform additional activities to manage exceptions as communicated by T2S
 8 using status advice messages. The CSD and the CSD Participant must analyse the status advice messages to
 9 determine which status changes or reason code updates require additional action to be taken by CSD or CSD
 10 Participants (like arrange for securities positions or cash balances in case of insufficient resources, rejection
 11 of settlement instruction or cancellation of settlement instruction by T2S), whereas others may be purely

1 informational and do not require any action to be taken (like receiving a status advices with reason code
 2 specifying instruction on COSD Hold or instructing awaiting release from Administering Party).

3 **2.2.3.5 RECEIVE AND MANAGE SETTLEMENT ALLEGEMENT**

Reference ID	T2S.BPD.SETT.CCSD.04
--------------	----------------------

4 T2S Actors: Counterparty (CSD / CSD Participant)

5 The Counterparty may receive a Settlement Allegement and may conduct additional tasks related to
 6 management of allegements.

7 For details on management of allegements, refer to process “Management of Allegement
 8 [T2S.BPD.SETT.ALEG]”.

9 The Counterparty receives the following message from T2S:

10 **Table 2-14: Messages from T2S [T2S.BPD.SETT.CCSD.04]**

Message Name	ISO Code	To/From T2S	Event	UDFS Chapter
SecuritiesSettlementTransactionAllegementNotificationV03	Sese.028.001.03	From T2S	No matching counterparty instruction exists	3.3.8.8

11 **2.2.3.6 RECEIVE SETTLEMENT INSTRUCTION COPY**

Reference ID	T2S.BPD.SETT.CCSD.05
--------------	----------------------

12 T2S Actors: CSD Participant (Scenario A)/CSD (Scenario B)

13 The CSD Participant [CSD] receives a copy of the settlement instruction initiated by the CSD [CSD
 14 Participant] on securities account owned by the CSD Participant.

15 The CSD Participant [CSD] stores the CSD [CSD Participant] initiated settlement instruction (copy) and
 16 references the same upon receipt of status updates and confirmations from T2S.

17 The CSD Participant [CSD] receives the following message from T2S:

18 **Table 2-15: Messages from T2S [T2S.BPD.SETT.CCSD.05]**

Message Name	ISO Code	To/From T2S	Event	UDFS Chapter
SecuritiesSettlementTransactionInstructionV03	Sese.023.001.03	From T2S	Successful validation of the Settlement Instruction sent by the CSD	3.3.8.4

1 **2.2.3.7 MANAGE SETTLEMENT RESULTS**

Reference ID	T2S.BPD.SETT.CCSD.06
--------------	----------------------

2 T2S Actors: Intermediary CSD (both scenarios)

3 The Intermediary CSD receives the T2S generated settlement instructions for realignment of the securities
4 positions in its books.

5 There is no intermediating CSD in business scenarios where the two counterparty CSDs have a direct link
6 with each other.

7 References:

8 UDFS: Use Case “Send Settlement Instruction” (Chapter 2.3)

9 **2.2.3.8 RECEIVE NOTIFICATION**

Reference ID	T2S.BPD.SETT.CCSD.07
--------------	----------------------

10 T2S Actors: Payment Bank and Central Bank (both scenarios)

11 The Payment Bank and Central Bank receive a notification whenever a securities settlement instruction
12 results in the debit or credit of one of their T2S dedicated cash accounts. If the cash posting has caused the
13 T2S dedicated cash account to be lower than the floor or higher than the ceiling thresholds T2S sends a
14 second notification message. The Payment Bank and Central Bank may conduct additional tasks such as
15 updating cash registers of the Payment Bank/Central Bank and liquidity management activities (e.g. resulting
16 in a transfer of cash from or to T2S).

17

1 The Payment Bank and Central Bank receive the following messages from T2S:

2 **Table 2-16: Messages from T2S [T2S.BPD.SETT.CCSD.07]**

Message Name	ISO Code	To/From T2S	Event	UDFS Chapter
BankToCustomerDebitCreditNotificationV03	Camt.054.001.03	From T2S	Debit or Credit posting on T2S dedicated cash account	3.3.3.17
ReturnAccountV05	Camt.004.001.05	From T2S	Cash balance after the posting on the dedicated cash account is below the floor or above the ceiling thresholds set-up for the dedicated cash account	3.3.3.2

3

1 **2.3 EXTERNAL CSD SETTLEMENT (INVOLVING CSD OUTSIDE T2S)**
 2 **[T2S.BPD.ECSD]**

3 **2.3.1 ABOUT EXTERNAL-CSD SETTLEMENT**

4 The concept of external-CSD settlement is specific to T2S. The external CSD settlement process refers to the
 5 transfer of securities positions between the securities accounts of participants belonging to two different
 6 CSDs (with direct or indirect CSD links with each other) wherein either one Investor CSD (i.e. counterparty
 7 CSD) or the Issuer CSD is outside T2S. The transfer of securities is similar to cross CSD settlement process
 8 except that some CSDs in the delivering or receiving chain may not be in T2S. Various business scenarios
 9 are possible depending on the combination of Investor CSDs, Issuer CSD and Intermediary CSD(s). In this
 10 context an Intermediary CSD is defined as a CSD that is part of the delivering or receiving chain of
 11 intermediaries (e.g. in case CSD C is linked to CSD A via another CSD E, the CSD E is called an
 12 Intermediary CSD).

13 **Business Scenario 1:**

14 In this business scenario, both Investor CSDs (i.e. counterparty CSDs) are outside T2S and only the Issuer
 15 CSD is in T2S. The Investor CSDs have securities accounts in the Issuer CSD. The transfer of securities
 16 takes place as an intra-CSD settlement, because the Investor CSDs (outside T2S) are CSD Participants of the
 17 Issuer CSD (in T2S).

18 For details on the process flow of this scenario, refer to process “Intra-CSD Settlement
 19 [T2S.BPD.SETT.ICSD]”.

20 **Figure 2-3: External-CSD Settlement - Business Scenario 1**

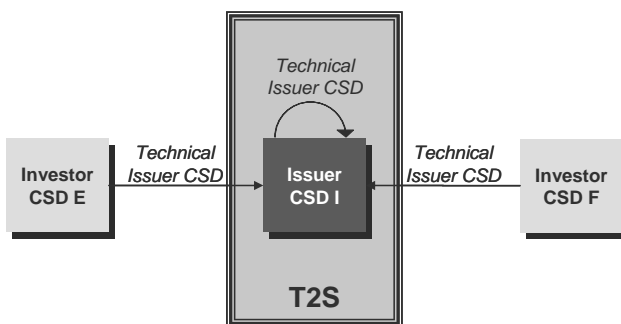

21

22 **Business Scenario 2:**

23 In this business scenario, the transfer of securities takes place from an Investor CSD in T2S to an Investor
 24 CSD (i.e. counterparty CSD) outside T2S, while the Issuer CSD is in T2S. The Investor CSD in T2S has a
 25 direct or indirect relationship with the Issuer CSD and the Investor CSD outside T2S owns a securities

1 account in the Issuer CSD. The transfer of securities takes place as a cross-CSD settlement, because the
 2 Investor CSD (outside T2S) is a CSD Participant of the Issuer CSD (in T2S).
 3 For details on the process flow of this scenario, refer to process “Cross-CSD Settlement (with CSD inside
 4 T2S) [T2S.BPD.SETT.CCSD]”.

5 **Figure 2-4: External-CSD Settlement - Business Scenario 2**

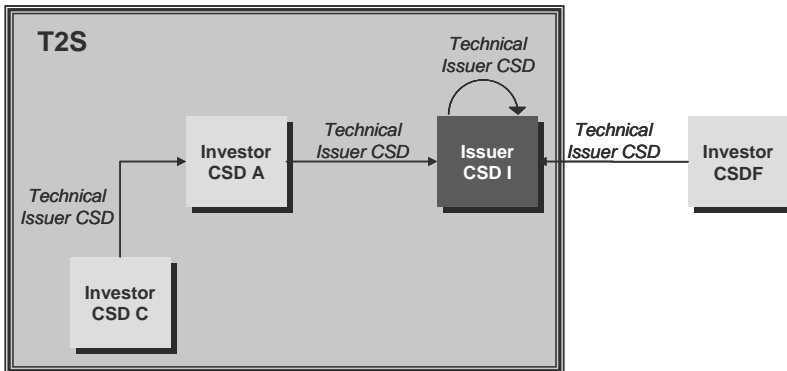

6
 7 **Business Scenario 3:**

8 In this business scenario both Investor CSDs (i.e. counterparty CSDs) are in T2S and only the Issuer CSD is
 9 outside T2S. The CSDs directly linked to the Issuer CSD (CSD A and CSD B in the diagram below) must
 10 realign the securities positions in the books of Issuer CSD. In this scenario, CSD A and CSD B are the Last
 11 CSD in T2S.¹⁴ The Intermediary CSD that maintains link with the CSD outside T2S is called the Last CSD
 12 in T2S. However, settlement in T2S is unconditional and does not depend upon the status of realignment in
 13 the books of Issuer CSD.

14 This scenario is described below under “External-CSD Settlement with both Investor CSDs in T2S and the
 15 Issuer CSD outside T2S [T2S.BPD.SETT.ECSD/Var.1]”.

¹⁴ In the context of the external-CSD settlement process the external CSD needs to be determined outside T2S among the T2S Parties involved.

1 **Figure 2-5: External-CSD Settlement - Business Scenario 3**

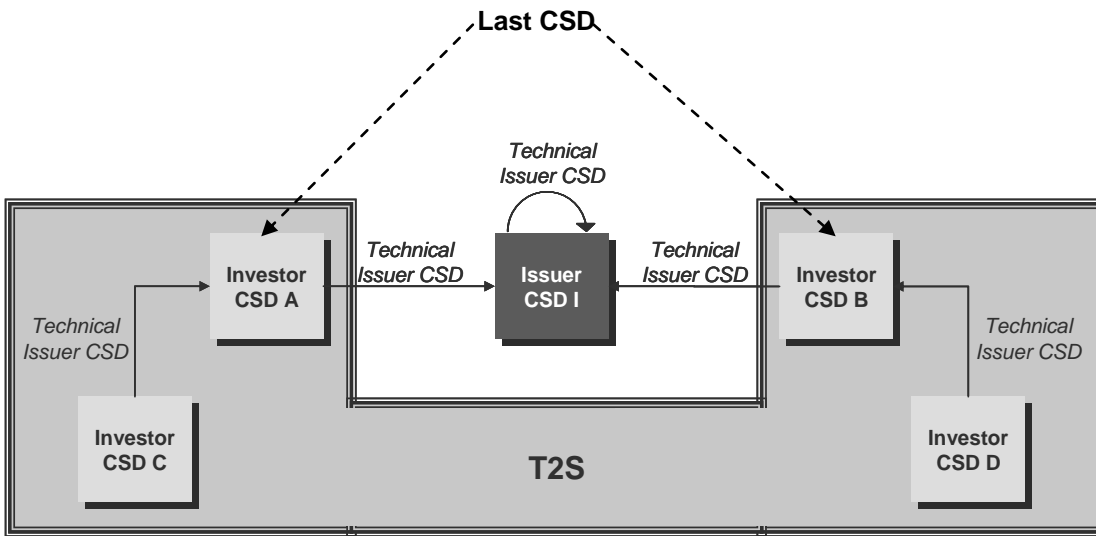

2

3 **Business Scenario 4:**

4 In this business scenario, the transfer of securities takes place from an Investor CSD in T2S to an Investor
 5 CSD (i.e. counterparty CSD) outside T2S, while the Issuer CSD is also outside T2S. The Investor CSD in
 6 T2S has a direct or indirect relationship with the Issuer CSD and the Investor CSD (i.e. counterparty CSD)
 7 outside T2S owns a securities account in the Issuer CSD.

8 The settlement in T2S is conditional and depends on the settlement of the trade outside T2S (i.e. in the books
 9 of the Issuer CSD). The Intermediary CSD that maintains link with the CSD outside T2S is called the Last
 10 CSD in T2S. In the Figure 2-5 below, CSD A is the Last CSD in T2S. The Last CSD in T2S is responsible
 11 for the realignment of securities positions in the books of CSDs outside T2S. In order to do so, the Last CSD
 12 in T2S (also acts as the Administering Party) must have set-up the Conditional Securities Delivery (CoSD)
 13 rules in T2S. The CoSD process will ensure that the CSDs linked to the Issuer CSD (CSD A and CSD F in
 14 the diagram below) can transfer the securities positions in the books of Issuer CSD before the settlement
 15 takes place in T2S.

16 This scenario is described below under “External CSD Settlement with one Investor CSD in T2S and the
 17 Issuer CSD outside T2S [T2S.BPD.SETT.ECSD/Var.2]”.

1 **Figure 2-6: External-CSD Settlement - Business Scenario 4**

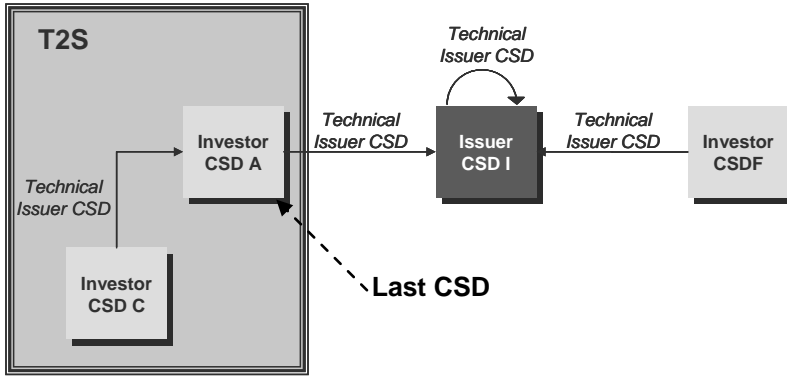

2

3

1 **2.3.2 EXTERNAL-CSD SETTLEMENT WITH BOTH INVESTOR CSDS IN T2S**
 2 **AND THE ISSUER CSD OUTSIDE T2S [T2S.BPD.SETT.ECSD/VAR.1]**

3 **2.3.2.1 OVERVIEW**

4 This process describes the act of transferring securities positions between the securities accounts of two
 5 Investor CSDs (i.e. counterparty CSDs) in T2S, while the Issuer CSD is outside T2S. In this business
 6 scenario the CSDs linked to the Issuer CSD must realign the securities positions in the books of the Issuer
 7 CSD. However, settlement in T2S is unconditional and does not depend upon the status of realignment in the
 8 books of Issuer CSD.

9 **Figure 2-7: External-CSD Settlement with both Investor CSDs in T2S and the Issuer CSD outside T2S**

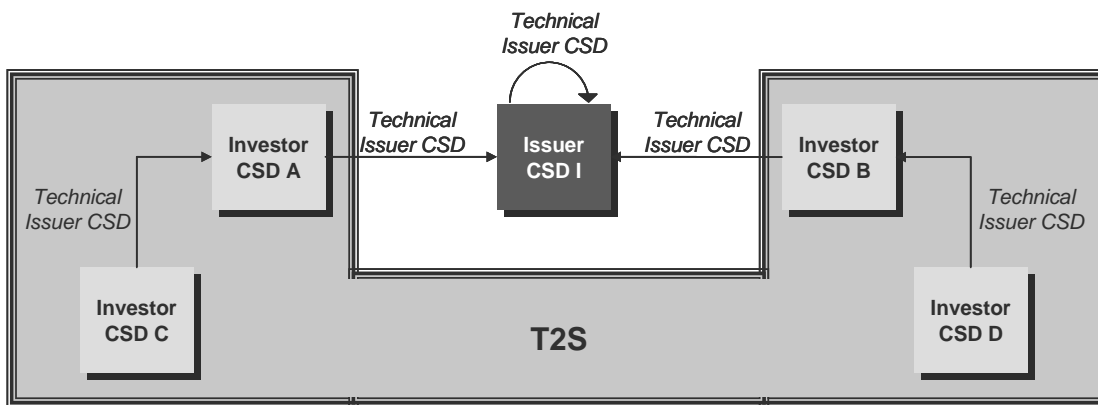

10

11 For examples of bookings on accounts in an External-CSD scenario, refer to UDFS Chapter 1.6.1.10
 12 “Realignment”.

13 **Trigger:**

- 14 • The CSD receives instructions from its CSD Participant or third parties authorised by the CSD
 15 Participant to instruct on its behalf.
- 16 • The CSD Participant itself or third parties acting on behalf of the CSD Participant¹⁵ (e.g. acting as
 17 account operators or custodians) receive instructions from their clients (e.g. end investors or financial
 18 institutions). If the CSD granted this CSD Participant sufficient privileges to directly send settlement
 19 instruction to the settlement engine (i.e. not via the CSD).

20 **Preconditions:**

21 Before the start of an external CSD settlement in T2S, each CSD must have completed the set-up of cross
 22 CSD links with other transacting CSD in T2S, as specified below.

¹⁵ Example 1: A CCP acting as a CSD Participant receives details of trades executed on a stock exchange, performs trade validation and instructs T2S. Example 2: A stock exchanges (acting as a CSD Participant) may be authorised by the CSD Participants (i.e. owner of the securities accounts debited/credited in the securities settlement) to instruct on behalf of the CSD Participants.

- 1 • Security CSD Links – specifies for a CSD the eligibility of a security for settlement and the technical
- 2 Issuer CSD for the security. The Last CSD in T2S in the delivering or receiving CSD chain in T2S must
- 3 have specified the external CSD as its Technical Issuer.
- 4 • CSD Account Links – specifies (depending on the participants account, if needed) the mirror, inter-CSD
- 5 and omnibus accounts between an investor CSD and its technical Issuer CSD.
- 6 • Eligible Counterpart CSD – specifies that two CSDs allow settlement of a specific security or set of
- 7 securities between them.

8 **T2S Instructing Party:**

9 There are two scenarios for the instruction of T2S:

- 10 • Scenario A: CSD instructs T2S.
- 11 • Scenario B: CSD Participant instructs T2S.

12 **2.3.2.2 BUSINESS PROCESS DIAGRAM**

13 **Figure 2-8: Business Process Diagram [T2S.BPD.SETT.ECSD/Var. 1]**

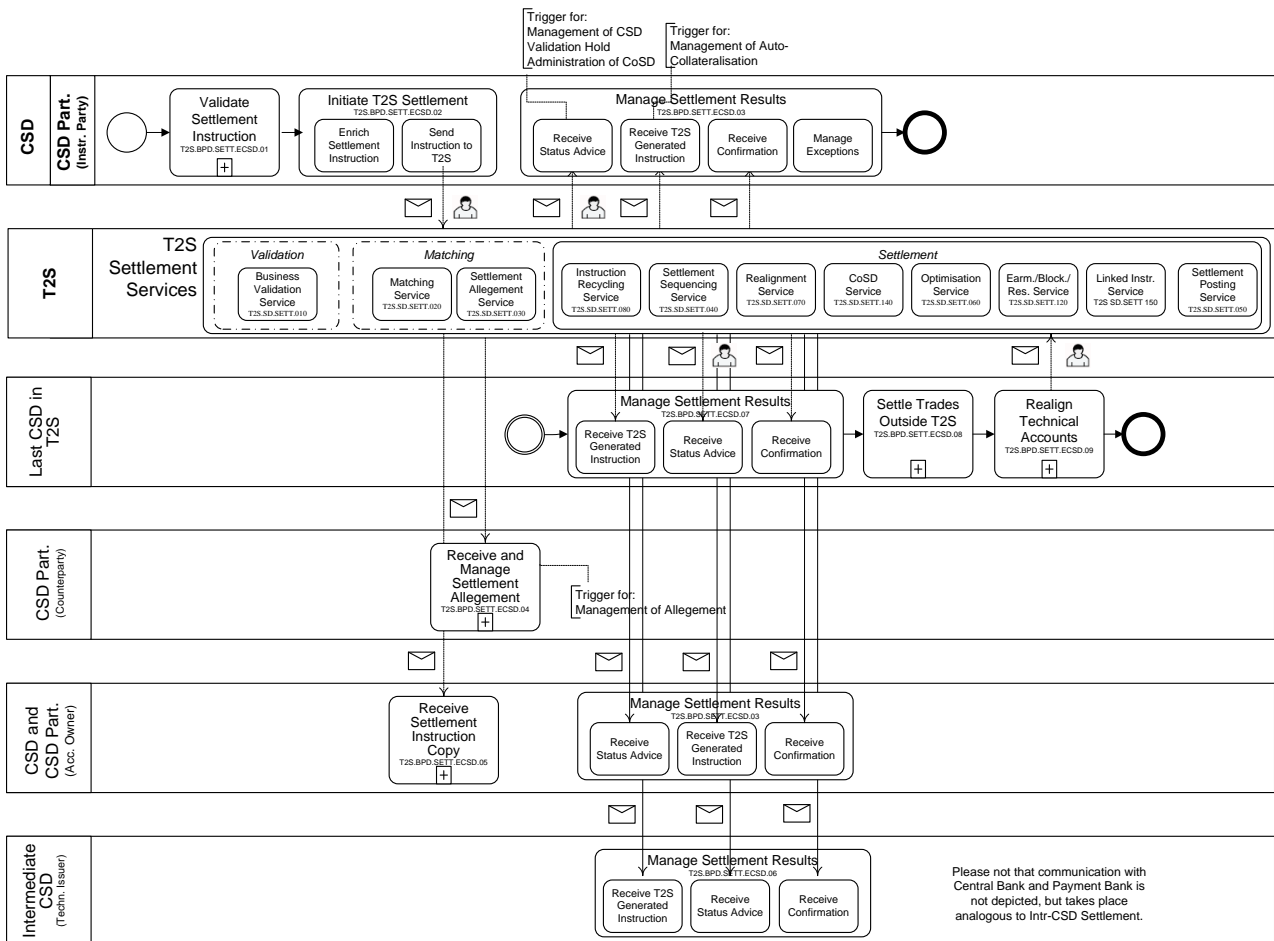

14

1 **2.3.2.3 BUSINESS PROCESS DESCRIPTION**

2 This Business Process Description is applicable to Scenario A and B unless otherwise noted. For the purpose
 3 of readability, the actor names in the text refer to Scenario A with the Scenario B actor indicated in square
 4 brackets.

5 **2.3.2.3.1 Validate Settlement Instruction**

Reference ID	T2S.BPD.SETT.ECSD.01
--------------	----------------------

6 T2S Actors: CSD (Scenario A)/CSD Participant (Scenario B)

7 The CSD [CSD Participant] checks all the details in the settlement instruction against the reference data
 8 (maintained by the CSD or CSD Participant) and may perform additional validations specific to the market
 9 practices or national regulations (if any)¹⁶. The CSD [CSD Participant] may also perform validations
 10 regarding securities settlement with the counterparty’s CSD.

11 It is not possible to send already matched instructions, if the two legs of the settlement instruction belong to
 12 two different CSDs.

13 **2.3.2.3.2 Initiate T2S Settlement**

Reference ID	T2S.BPD.SETT.ECSD.02
--------------	----------------------

14 T2S Actors: CSD (Scenario A)/CSD Participant (Scenario B)

15 The CSD [CSD Participant] enriches the settlement instruction with details required for settlement
 16 processing in T2S and sends the settlement instruction to T2S.

17 References:

18 UDFS: Use Case “Send Settlement Instruction” (Chapter 2.3)

19 GUI BFD: T2S.GUI.SESE.INX.0070

20 **2.3.2.3.3 Enrich Settlement Instruction**

Reference ID	T2S.BPD.SETT.ECSD.02.01
--------------	-------------------------

21 The CSD [CSD Participant] enriches the settlement instructions with T2S specific information such as T2S
 22 securities account number, T2S dedicated cash account number and delivery and receipt securities position
 23 types/cash balance types (e.g. deliver or receive into earmarked position type, deliver from a blocked or

¹⁶ The T2S restrictions framework also offers the option of setting up market specific processing validations. Refer to the BPD for “Maintain Restrictions” for the description of set-up and maintenance of restrictions.

1 reserved securities position using the specific restriction references). The CSD [CSD Participant] also
 2 populates other key parameters such as T2S process indicators (e.g. partial settlement indicator, hold/release
 3 indicator, etc.) that influence the settlement processing in T2S, unless the default values are to be used for the
 4 instruction.

5 **2.3.2.3.4 Send Settlement Instruction to T2S**

Reference ID	T2S.BPD.SETT.ECSD.02.02
--------------	-------------------------

6 The CSD [CSD Participant] converts the settlement instruction enriched with T2S specific information and
 7 T2S process indicators into the required message format and transmits it to T2S. The processing of
 8 settlement instruction in T2S depends on the specified values of the T2S process indicators in the settlement
 9 instruction.

10 The instruction of T2S is also possible via the T2S GUI.

11 The CSD [CSD Participant] sends the following message to T2S:

12 **Table 2-17: Messages to T2S [T2S.BPD.SETT.ECSD.02.02]**

Message Name	ISO Code	To/From T2S	UDFS Chapter
SecuritiesSettlementTransactionInstructionV03	Sese.023.001.03	To T2S	3.3.8.4

13 **2.3.2.3.5 T2S Processing**

14 The **Business Validation Service (T2S.SD.SETT.010)** validates the incoming settlement instruction for the
 15 standard set of validations and CSD specific rules. If the service identifies an external CSD settlement
 16 scenario specific validations for this scenario are performed.

17 For details on the remaining services involved, refer to process “Intra-CSD Settlement
 18 [T2S.BPD.SETT.ICSD]”.

19 For examples of bookings on accounts in an External-CSD scenario, refer to UDFS Chapter 1.6.1.10
 20 “Realignment”.

21 **2.3.2.3.6 Manage Settlement Results**

Reference ID	T2S.BPD.SETT.ECSD.03
--------------	----------------------

22 T2S Actors: CSD and CSD Participant (both scenarios)

23 The CSD and CSD Participant receive the settlement related messages from T2S and initiate related internal
 24 processes.

1 In both scenarios, the CSD and the CSD Participant receive the messages. When a CSD instructs T2S
 2 (Scenario A), the CSD Participant (if directly connected) can also receive these messages. Similarly, when
 3 the CSD Participant instructs T2S (Scenario B), the CSD can also receive the messages.

4 References:

5 UDFS: Use Case “Send Settlement Instruction” (Chapter 2.3)

6 **2.3.2.3.7 Receive Status Advice**

Reference ID	T2S.BPD.SETT.ECSD.03.01
--------------	-------------------------

7 The CSD and CSD Participant receive status advice messages sent by T2S to indicate a status change or
 8 reason code update for the settlement instruction within T2S.

9 If T2S has been instructed via the T2S GUI the status is shown on the screen and status advice message are
 10 sent to the CSD and CSD Participant.

11 In addition to the status updates on the settlement instruction sent by the CSD [CSD Participant], the CSD
 12 and CSD Participant also receive other updates described below.

13 For Conditional Securities Delivery (CoSD) processing, refer to process “Administration of CoSD
 14 [T2S.BPD.SETT.COSD]”.

15 For CSD Validation Hold processing, refer to process “Management of CSD Validation Hold
 16 [T2S.BPD.SETT.CSDH]”.

17 For Auto-Collateralisation processing, refer to process “Management of Auto-Collateralisation
 18 [T2S.BPD.SETT.ACOL]”.

19 For Realignments processing, the CSD and CSD Participant receive a status advice for T2S generated
 20 settlement instructions.

21 For Restriction Rejection processing (CSD specific validations), the CSD and CSD Participant receive a
 22 status advice for the settlement instruction that specifies that the settlement instruction is rejected and the
 23 applicable restriction rule.

24 For Pre-emption processing, the CSD and CSD Participant receive a status advice for a pending settlement
 25 instruction that may settle partially as a result of incoming resources (partial settlement – unsettled part).

26 For Securities Accounts “On Hold” processing, the CSD and CSD Participant receive a status advice
 27 specifying that the settlement instruction is put on “Party Hold”.

28 Following the message reception, other internal activities might be conducted such as:

- 1 • aligning the status of the settlement instruction in the CSD’s or CSD Participant’s systems with the status
- 2 in T2S,
- 3 • exception management,
- 4 • amending the settlement instruction,
- 5 • sending additional settlement instructions,
- 6 • triggering notification to CSD Participants.

7 The CSD and CSD Participant receive the following messages from T2S:

8 **Table 2-18: Messages from T2S [T2S.BPD.SETT.ECSD.03.01]**

Message Name	ISO Code	To/From T2S	Event	UDFS Chapter	Exception Handling
SecuritiesSettlementTransactionStatusAdviceV03	Sese.024.001.03	From T2S	Change in status of settlement instruction	3.3.8.5	This message will also be used to inform about rejection, cancellation and reason codes updates (e.g. insufficient positions, cash balances, blocking of party, etc)
SecuritiesSettlementConditionModificationStatusAdviceV03	Sese.031.001.03	From T2S	Settlement instruction is subject to CoSD Hold	3.3.8.11	

9 **2.3.2.3.8 Receive T2S Generated Instruction**

Reference ID	T2S.BPD.SETT.ECSD.03.02
--------------	-------------------------

10 The CSD and CSD Participant receive the messages for T2S generated instructions. T2S may generate
 11 additional instructions due to various T2S processes triggered by the first settlement instruction.

12 For details on management of auto-collateralisation, refer to process “Management of auto-collateralisation
 13 [T2S.BPD.SETT.ACOL]”.

14

1 **Table 2-19: Mapping of T2S Generated Instruction and T2S Processes [T2S.BPD.SETT.ECSD.03.02]**

No:	T2S Generated Instructions	T2S Processes
1	Settlement Instructions	Realignments in cross CSD settlements scenarios Auto-collateralisation and Reverse Auto-collateralisation
2	Settlement Restrictions (informed via Intra-position or Intra-balance movement status advice)	Use of blocked or reserved securities or cash in the settlement instruction Auto-collateralisation and Reverse Auto-collateralisation

2 The CSD and CSD Participant receive the following messages from T2S:

3 **Table 2-20: Messages from T2S [T2S.BPD.SETT.ECSD.03.02]**

Message Name	ISO Code	To/From T2S	Event	UDFS Chapter
SecuritiesSettlementTransactionGenerationNotificationV03	Sese.032.001.03	From T2S	Generation of settlement instructions by T2S due to Realignments	3.3.8.12

4 **2.3.2.3.9 Receive Settlement Confirmation**

Reference ID	T2S.BPD.SETT.ECSD.03.03
--------------	-------------------------

5 The CSD and CSD Participant receive and validate settlement confirmation messages for the settlement
 6 instructions sent to T2S, T2S generated settlement instructions and Settlement Restrictions (if applicable).

7 Following the message reception, other internal activities might be conducted such as:

- 8 • aligning the status of the settlement instruction in the CSD’s or CSD Participant’s books with the status
 9 in T2S,
- 10 • sending additional settlement instructions,
- 11 • triggering notification to CSD Participants,
- 12 • performing the registration of securities.

13

1 The CSD and CSD Participant receive the following messages from T2S:

2 **Table 2-21: Messages from T2S [T2S.BPD.SETT.ECSD.03.03]**

Message Name	ISO Code	To/From T2S	Event	UDFS Chapter
SecuritiesSettlementTransactionConfirmationV03	Sese.025.001.03	From T2S	Partial or Full settlement of the settlement instruction or T2S generated settlement instruction	3.3.8.6
IntraPositionMovementConfirmation	Semt.015.001.03	From T2S	1. Blocked or reserved securities have been used for settlement of the settlement instruction. 2. Reservation of securities positions as a result of pre-emption of incoming resources	3.3.7.4
IntraBalanceMovementConfirmationV01	Camt.068.001.01	From T2S	1. Use of blocked or reserved cash for settlement of a settlement instruction 2. Reservation of cash as a result of pre-emption of incoming resources	3.3.3.22

3 **2.3.2.3.10 Receive and Manage Settlement Allegement**

Reference ID	T2S.BPD.SETT.ECSD.04
--------------	----------------------

4 T2S Actors: Counterparty (CSD / CSD Participant)

5 The Counterparty receives a Settlement Allegement and may conduct additional tasks related to management
6 of allegements.

7 For details on the management of allegements, refer to process “Management of Allegement
8 [T2S.BPD.SETT.ALEG]”.

9

1 The Counterparty receives the following messages from T2S:

2 **Table 2-22: Messages from T2S [T2S.BPD.SETT.ECSD.04]**

Message Name	ISO Code	To/From T2S	Event	UDFS Chapter
SecuritiesSettlementTransactionAllegationNotificationV03	Sese.028.001.03	From T2S	No matching counterparty instruction exists	3.3.8.8

3 **2.3.2.3.11 Receive Settlement Instruction Copy**

Reference ID	T2S.BPD.SETT.ECSD.05
--------------	----------------------

4 T2S Actors: CSD Participant (Scenario A)/CSD (Scenario B)

5 The CSD Participant [CSD] receives a copy of the settlement instruction initiated by the CSD [CSD
6 Participant] on securities account owned by the CSD Participant.

7 The CSD Participant [CSD] stores the CSD [CSD Participant] initiated settlement instruction (copy) and
8 references the same upon receipt of status updates and confirmations from T2S

9 The CSD Participant [CSD] receives the following message from T2S:

10 **Table 2-23: Messages from T2S [T2S.BPD.SETT.ECSD.05]**

Message Name	ISO Code	To/From T2S	Event	UDFS Chapter
SecuritiesSettlementTransactionInstructionV03	Sese.023.001.03	From T2S	Successful validation of the Settlement Instruction sent by the CSD	3.3.8.4

11 **2.3.2.3.12 Manage Settlement Results**

Reference ID	T2S.BPD.SETT.ECSD.06
--------------	----------------------

12 T2S Actors: Intermediary CSD

13 The Intermediary CSD receives the T2S generated settlement instructions for realignment of the securities
14 positions in the books of the intermediating CSD. The Intermediary CSD stores T2S generated settlement
15 instructions and references the same upon receipt of status updates and confirmations from T2S.

16 There will be no Intermediating CSD in business scenarios wherein the counterparty CSDs have a direct link
17 with the Last CSD in the delivering CSD (or receiving CSD) chain in T2S.

18

1 **2.3.2.3.13 Manage Settlement Results**

Reference ID	T2S.BPD.SETT.ECSD.07
--------------	----------------------

2 T2S Actors: Last CSD in T2S

3 The Last CSD in T2S receives the T2S generated settlement instructions for realignment of the securities
4 positions in the books of the Last CSD in T2S (i.e. the technical issuer for this CSD is not in T2S).

5 The Last CSD in T2S stores T2S generated settlement instructions and updates them upon receipt of status
6 updates and confirmations from T2S. In addition, the Last CSD in T2S may use the T2S generated settlement
7 instruction for instructing the realignment of securities positions in the books of its technical Issuer CSD.

8 The settlement takes place on the Inter-CSD account vis-à-vis the participant (or omnibus account) in the
9 Last CSD in T2S.

10 **2.3.2.3.14 Settle Trades Outside T2S**

Reference ID	T2S.BPD.SETT.ECSD.08
--------------	----------------------

11 T2S Actors: Last CSD in T2S

12 The Last CSD in T2S initiates this process after receiving the confirmations for trade settlement in T2S. The
13 Last CSD in T2S creates and sends settlement instructions to the Issuer CSD (external to T2S).

14 For instructing in the Issuer CSD, the Last CSD in T2S may use the information contained in the realignment
15 instructions generated by T2S or refer to information received from the delivering/receiving CSD. These
16 settlement instructions settle outside T2S and result in the realignment of securities positions in the accounts
17 of the Last CSDs in T2S.

18 **2.3.2.3.15 Realign Technical Accounts in T2S**

Reference ID	T2S.BPD.SETT.ECSD.09
--------------	----------------------

19 T2S Actors: Last CSD in T2S

20 The Last CSD in T2S creates and sends settlement instructions to T2S for realignment of securities positions
21 in T2S which results in a movement of securities from the inter-CSD account to the mirror account and vice
22 versa. This movement aligns the mirror account (i.e. account in the books of last intermediating CSD) with
23 the omnibus account of the CSD (i.e. account in the books of its technical Issuer CSD).

24

1 The Last CSD in T2S sends the following message to T2S:

2 **Table 2-24: Messages to T2S [T2S.BPD.SETT.ECSD.02.02]**

Message Name	ISO Code	To/From T2S	UDFS Chapter
SecuritiesSettlementTransactionInstructionV03	Sese.023.001.03	To T2S	3.3.8.4

3 **2.3.2.3.16 Receive Notification**

Reference ID	T2S.BPD.SETT.ECSD.10
--------------	----------------------

4 T2S Actors: Payment Bank and Central Bank

5 The Payment Bank and Central Bank receive a notification whenever a securities settlement instruction
 6 results in the debit or credit of one of their T2S dedicated cash accounts. If the cash posting has caused the
 7 T2S dedicated cash account to be lower than the floor or higher than the ceiling thresholds T2S sends a
 8 second notification message. The Payment Bank and Central Bank may conduct additional tasks such as
 9 updating cash registers of the Payment Bank/Central Bank and liquidity management activities (e.g. resulting
 10 in a transfer of cash from or to T2S).

11 The Payment Bank and Central Bank receive the following messages from T2S:

12 **Table 2-25: Messages from T2S [T2S.BPD.SETT.ECSD.10]**

Message Name	ISO Code	To/From T2S	Event	UDFS Chapter
BankToCustomerDebitCreditNotificationV03	Camt.054.001.03	From T2S	Debit or Credit posting on T2S dedicated cash account	3.3.3.17
ReturnAccountV05	Camt.004.001.05	From T2S	Cash balance after the posting on the dedicated cash account is below the floor or above the ceiling thresholds set-up for the dedicated cash account	3.3.3.2

13

1 **2.3.3 EXTERNAL CSD SETTLEMENT WITH ONE INVESTOR CSD IN T2S AND**
 2 **THE ISSUER CSD OUTSIDE T2S [T2S.BPD.SETT.ECSD/VAR.2]**

3 **2.3.3.1 OVERVIEW**

4 This process describes the act of transferring securities positions between the securities accounts of an
 5 Investor CSD in T2S to an Investor CSD (i.e. counterparty CSD) outside T2S, while the Issuer CSD is also
 6 outside T2S. The Investor CSD in T2S has a direct or indirect relationship with the Issuer CSD and the
 7 Investor CSD outside T2S owns a securities account in the Issuer CSD.

8 In this business scenario, the settlement in T2S is conditional and depends on the settlement of the trade
 9 outside T2S (i.e. in the books of the Issuer CSD). The Last CSD in T2S must have set-up the Conditional
 10 Securities Delivery (CoSD) rules in T2S. The CoSD process will ensure that the CSDs linked to the Issuer
 11 CSD transfer the securities positions in the books of Issuer CSD before the settlement takes place in T2S. In
 12 case of an indirect link between the delivering and receiving CSDs, the chain of intermediaries will involve
 13 one or more CSDs.

14 **Figure 2-9: External CSD Settlement with one Investor CSD in T2S and the Issuer CSD outside T2S**

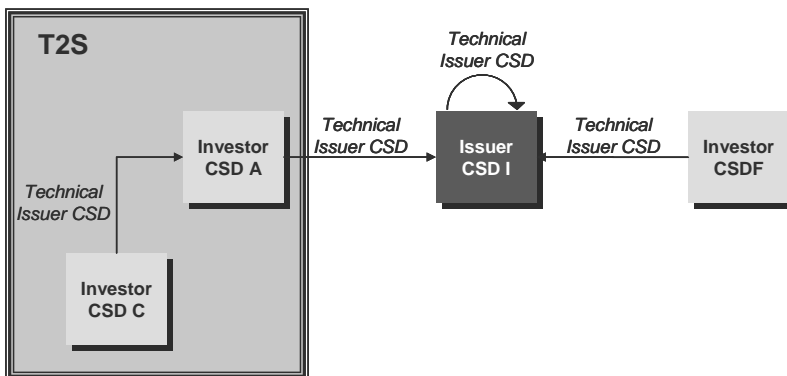

15
 16 For examples of bookings on accounts in an External-CSD scenario, refer to UDFS Chapter 1.6.1.10
 17 “Realignment”.

18 **Trigger:**

- 19 • CSD(s) receive settlement instructions from the CSD Participants or third parties authorised by the CSD
 20 Participant to instruct on their behalf. In some cases, the CSD Participants may authorise the CSD itself
 21 to create settlement instructions on behalf of the CSD Participant.

- 1 • CSD Participants¹⁷ (acting as account operators or custodians and with privileges granted by their CSD
2 to instruct directly in T2S) receive settlement instructions from their clients (e.g. end investors or
3 financial institutions).

4 **Preconditions:**

5 Before the start of an external CSD settlement in T2S, each CSD must have completed the set-up of cross-
6 CSD links with other transacting CSDs in T2S, as specified below:

- 7 • Security CSD Links – specifies for a CSD the eligibility of a security for settlement and the technical
8 Issuer CSD for the security. The Last CSD in the delivering or receiving CSD chain in T2S must have
9 specified the external CSD as its Technical Issuer.
- 10 • CSD Account Links – specifies (depending on the participants account, if needed) the mirror, inter-CSD
11 and omnibus accounts between an investor CSD and its technical Issuer CSD.
- 12 • Eligible Counterpart CSD – specifies that two CSDs allow settlement of a specific security or set of
13 securities between them.
- 14 • The Last CSD in T2S must complete the set-up of CoSD rules in T2S static data.

15 **T2S Instructing Party:**

16 There are two scenarios for the instruction of T2S:

- 17 • Scenario A: CSD instructs T2S.
- 18 • Scenario B: CSD Participant instructs T2S.

¹⁷ The CCP acting as a CSD Participant receives details of trades executed on a stock exchange and performs trade validation. The stock exchanges (also acting as a CSD Participant) may be authorised by the other CSD Participants (i.e. owner of the securities accounts debited/credited in the securities settlement) to instruct on behalf of the CSD Participants.

1 **2.3.3.2 BUSINESS PROCESS DIAGRAM**

2 **Figure 2-10: Business Process Diagram [T2S.BPD.SETT.ECSD/Var. 2]**

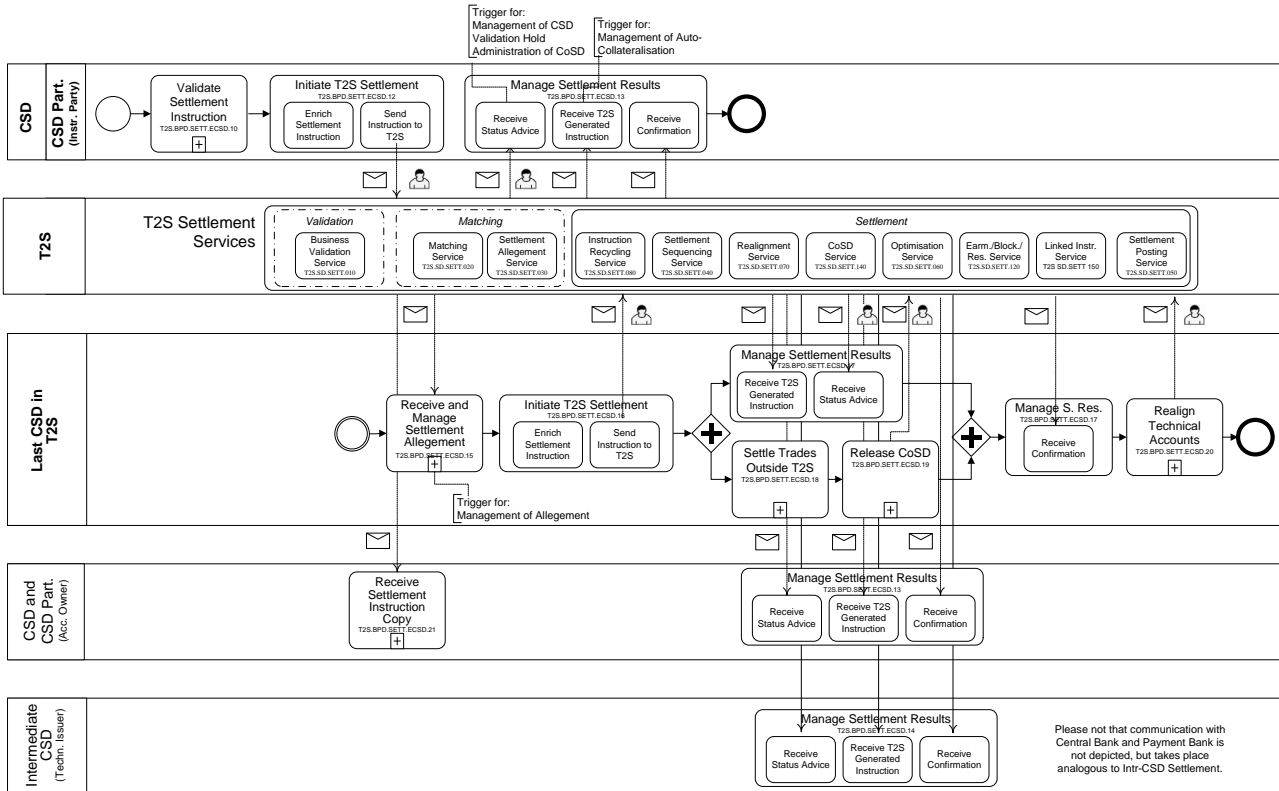

3

4 **2.3.3.3 BUSINESS PROCESS DESCRIPTION**

5 This Business Process Description is applicable to Scenario A and B unless otherwise noted. For the purpose
 6 of readability, the actor names in the text refer to Scenario A with the Scenario B actor indicated in square
 7 brackets.

8 **2.3.3.3.1 Validate Settlement Instruction**

Reference ID	T2S.BPD.SETT.ECSD.11
--------------	----------------------

9 T2S Actors: CSD (Scenario A)/CSD Participant (Scenario B)

10 The CSD [CSD Participant] checks all the details in the settlement instruction against the reference data
 11 (maintained by the CSD or CSD Participant) and may perform additional validations specific to the market
 12 practices or national regulations (if any)¹⁸. The CSD [CSD Participant] may also perform validations
 13 regarding securities settlement with the counterparty's CSD.

¹⁸ The T2S restrictions framework also offers the option of setting up market specific processing validations. Refer to the BPD for "Maintain Restrictions" for the description of set-up and maintenance of restrictions.

1 **2.3.3.3.2 Initiate T2S Settlement**

Reference ID	T2S.BPD.SETT.ECSD.12
--------------	----------------------

2 T2S Actors: CSD (Scenario A)/CSD Participant (Scenario B)

3 The CSD [CSD Participant] enriches the settlement instruction with details required for settlement
4 processing in T2S and sends the settlement instruction to T2S.

5 References:

6 UDFS: Use Case “Send Settlement Instruction” (Chapter 2.3)

7 GUI BFD: T2S.GUI.SESE.INX.0070

8 **2.3.3.3.3 Enrich Settlement Instruction**

Reference ID	T2S.BPD.SETT.ECSD.12.01
--------------	-------------------------

9 T2S Actors: CSD (Scenario A)/CSD Participant (Scenario B)

10 The CSD [CSD Participant] enriches the settlement instructions with T2S specific information such as T2S
11 securities account number, T2S dedicated cash account and delivery and receipt securities position
12 types/cash balance types (e.g. deliver or receive into earmarked position type, deliver from a blocked or
13 reserved securities position with specific restriction references). The CSD [CSD Participant] also populates
14 other key parameters such as T2S process indicators (e.g. partial settlement indicator, hold/release indicator
15 etc) required for settlements processing in T2S.

16 The CSD Participant receives information about the intermediaries involved in the settlement chain from its
17 counterparty. The CSD Participant analyses the delivering and receiving settlement chain and determines the
18 first CSD outside T2S in the end-to-end settlement chain. For the purpose of settlement in T2S, the CSD
19 Participant considers the intermediary holding a securities account in the first CSD outside T2S as their
20 counterparty and instructs T2S.

21 **2.3.3.3.4 Send Settlement Instruction to T2S**

Reference ID	T2S.BPD.SETT.ECSD.12.02
--------------	-------------------------

22 T2S Actors: CSD (Scenario A)/CSD Participant (Scenario B)

23 The CSD [CSD Participant] converts the settlement instruction enriched with T2S specific information and
24 T2S process indicators into the required message format and transmits it to T2S. The processing of
25 settlement instruction in T2S depends on the specified values of the T2S process indicators in the settlement
26 instruction.

- 1 The instruction of T2S is also possible via the T2S GUI.
- 2 The CSD [CSD Participant] sends the following message to T2S:

3 **Table 2-26: Messages form T2S [T2S.BPD.SETT.ECSD.12.02]**

Message Name	ISO Code	To/From T2S	UDFS Chapter
SecuritiesSettlementTransactionInstructionV03	Sese.023.001.03	To T2S	3.3.8.4

4 **2.3.3.3.5 T2S Processing**

5 The **Business Validation Service (T2S.SD.SETT.010)** validates the incoming settlement instruction for the
 6 standard set of validations and CSD specific rules. If the service identifies an external CSD settlement
 7 scenario specific validations for this scenario are performed.

8 For details on the remaining services involved, refer to process “Intra-CSD Settlement
 9 [T2S.BPD.SETT.ICSD]”.

10 For examples of bookings on accounts in an External-CSD scenario, refer to UDFS Chapter 1.6.1.10
 11 “Realignment”.

12 **2.3.3.3.6 Manage Settlement Results**

Reference ID	T2S.BPD.SETT.ECSD.13
--------------	----------------------

13 T2S Actors: CSD and CSD Participant (Both Scenarios)

14 The CSD and CSD Participant receive the settlement related messages from T2S and initiate related internal
 15 processes.

16 In both scenarios, the CSD and the CSD Participant receive the messages. When a CSD instructs T2S
 17 (Scenario A), the CSD Participant (if directly connected) can also receive these messages. Similarly, when
 18 the CSD Participant instructs T2S (Scenario B), the CSD can also receive the messages.

19 References:

20 UDFS: Use Case “Send Settlement Instruction” (Chapter 2.3)

21 **2.3.3.3.7 Receive Status Advice**

Reference ID	T2S.BPD.SETT.ECSD.13.01
--------------	-------------------------

22 The CSD and CSD Participant receive status advice messages for every change of status or update of reason
 23 code to the settlement instruction within T2S.

- 1 If T2S has been instructed via the T2S GUI the status is shown on the screen.
- 2 In addition to the status updates on the settlement instruction sent by the CSD [CSD Participant], the CSD
3 and CSD Participant also receive other updates described below.
- 4 For CSD Validation Hold processing, see “Management of CSD Validation Hold [T2S.BPD.SETT.CSDH]”.
- 5 For Auto-collateralisation processing, refer to process “Management of Auto-collateralisation
6 [T2S.BPD.SETT.ACOL]”.
- 7 For Conditional Securities Delivery (CoSD) processing,
- 8 • the CSD and CSD Participant receive a status advice (resulting from “Condition Modification
9 Instruction” created by T2S for CoSD processing) for applying the CoSD hold condition on the
10 settlement instruction,
 - 11 • the CSD and CSD Participant receive a status advice for intra-position/intra-balance movement in case
12 the CoSD blocking of cash or securities resources is not successful,
 - 13 • the CSD and CSD Participant receive a status advice due to the change in status of the settlement
14 instruction to CoSD hold¹⁹,
 - 15 • based on the CoSD rules defined in T2S by the Last CSD in the delivering or receiving chain in T2S, the
16 realignment instructions in the Last CSD in T2S are subject to CoSD hold processing.
- 17 For Realignments processing, the CSD and CSD Participant receive a status advice for T2S generated
18 settlement instructions.
- 19 For Restriction Rejection processing (CSD specific validations), the CSD and CSD Participant receive a
20 status advice for the settlement instruction that specifies that the settlement instruction is rejected and the
21 applicable restriction rule.
- 22 For Pre-emption processing, the CSD and CSD Participant receive a status advice for a pending settlement
23 instruction that may settle partially as a result of incoming resources (partial settlement – unsettled part).
- 24 For Securities Accounts “On Hold” processing, the CSD and CSD Participant receive a status advice
25 specifying that the settlement instruction is put on “Party Hold”.
- 26 Following the message reception, other internal activities might be conducted such as:
- 27 • aligning the status of the settlement instruction in the CSD or CSD Participant’s systems with the status
28 in T2S,

¹⁹ The Administering Party may either approve or cancel the COSD (see details in “Administration of Conditional Securities Delivery” BPD).

- 1 • exception management,
- 2 • amending the settlement instruction,
- 3 • sending additional settlement instructions,
- 4 • triggering notification to CSD Participants.

5 The CSD and CSD Participant receive the following messages from T2S:

6 **Table 2-27: Messages from T2S [T2S.BPD.SETT.ECSD.13.01]**

Message Name	ISO Code	To/From T2S	Event	UDFS Chapter	Exception Handling
SecuritiesSettlementTransactionStatusAdviceV03	Sese.024.001.03	From T2S	Change in status of settlement instruction	3.3.8.5	This message will also be used to inform about rejection, cancellation and reason codes updates (e.g. insufficient positions, cash balances, blocking of party, etc)
SecuritiesSettlementConditionModificationStatusAdviceV03	Sese.031.001.03	From T2S	Settlement instruction is subject to CoSD Hold	3.3.8.11	
IntraPositionMovementStatusAdviceV03	Semt.014.001.03	From T2S	CoSD Blocking of securities resources is not successful	3.3.7.3	
IntraBalanceMovementStatusAdviceV01	Camt.067.001.01	From T2S	CoSD Blocking of cash resources is not successful	3.3.3.21	This message will also be used to inform about rejection, cancellation and reason codes updates (e.g. insufficient positions, cash balances, blocking of party, etc)

1 **2.3.3.3.8 Receive T2S Generated Instruction**

Reference ID	T2S.BPD.SETT.ECSD.13.02
--------------	-------------------------

2 The CSD and CSD Participant receive the messages for T2S generated instructions. T2S may generate
3 additional instructions due to various T2S processes triggered by the first settlement instruction.

4 For details on management of auto-collateralisation, refer to process “Management of auto-collateralisation
5 [T2S.BPD.SETT.ACOL]”.

6 **Table 2-28: Mapping of T2S Generated Instruction and T2S Processes [T2S.BPD.SETT.ECSD.13.02]**

No:	T2S Generated Instructions	T2S Processes
1	Settlement Instructions	Realignments in cross CSD settlements scenarios Auto-collateralisation and Reverse Auto-collateralisation
2	Settlement Restrictions (informed via Intra-position or Intra-balance movement status advice)	Use of blocked or reserved securities or cash in the settlement instruction Auto-collateralisation and Reverse Auto-collateralisation

7 The CSD and CSD Participant receive the following messages from T2S:

8 **Table 2-29: Messages from T2S [T2S.BPD.SETT.ECSD.13.02]**

Message Name	ISO Code	To/From T2S	Event	UDFS Chapter
SecuritiesSettlementTransactionGenerationNotificationV03	Sese.032.001.03	From T2S	Generation of settlement instructions by T2S due to Realignments	3.3.8.12

9 **2.3.3.3.9 Receive Settlement Confirmation**

Reference ID	T2S.BPD.SETT.ECSD.13.03
--------------	-------------------------

10 The CSD and CSD Participant receive and validate settlement confirmation messages for the settlement
11 instructions sent to T2S, T2S generated settlement instructions and Settlement Restrictions (in case
12 applicable).

13 Following the message reception, other internal activities might be conducted such as:

- 14 • aligning the status of the settlement instruction in the CSD or CSD Participant’s books with the status in
15 T2S,

- 1 • sending additional settlement instructions,
 - 2 • triggering notification to CSD Participants,
 - 3 • performing the registration of securities.
- 4 The CSD and CSD Participant receive the following messages from T2S:

5 **Table 2-30: Messages from T2S [T2S.BPD.SETT.ECSD.13.03]**

Message Name	ISO Code	To/From T2S	Event	UDFS Chapter
SecuritiesSettlementTransactionConfirmationV03	Sese.025.001.03	From T2S	Partial or Full settlement of the settlement instruction or T2S generated settlement instruction	3.3.8.6

6 **2.3.3.3.10 Manage Exceptions**

Reference ID	T2S.BPD.SETT.ECSD.13.04
--------------	-------------------------

7 The CSD [CSD Participant] perform additional activities to manage exceptions as communicated by T2S
 8 using status advice messages.

9 The CSD and the CSD Participant must analyse the status advice messages to determine which status
 10 changes or reason code updates require additional action to be taken by CSD or CSD Participants (like
 11 arrange for securities positions or cash balances in case of insufficient resources), whereas others may be
 12 purely informational and do not require any action to be taken (like rejection of settlement instruction or
 13 cancellation of settlement instruction by T2S).

14 **2.3.3.3.11 Manage Settlement Results**

Reference ID	T2S.BPD.SETT.ECSD.14
--------------	----------------------

15 T2S Actors: Intermediary CSD

16 The Intermediary CSD receives the T2S generated settlement instructions for realignment of the securities
 17 positions in the books of the intermediating CSD. The Intermediary CSD stores T2S generated settlement
 18 instructions and references the same upon receipt of status updates and confirmations from T2S.

19 The Intermediary CSD is not required in business scenarios wherein the delivering or receiving CSD in T2S
 20 has a direct link with the Last CSD in the delivering CSD (or receiving CSD) chain in T2S.

21

1 **2.3.3.3.12 Receive and Manage Settlement Allegement**

Reference ID	T2S.BPD.SETT.ECSD.15
--------------	----------------------

2 T2S Actors: Counterparty

3 The Counterparty receives a Settlement Allegement and may conduct additional tasks related to management
4 of allegements.

5 For details on the management of allegements, refer to process “Management of Allegement
6 [T2S.BPD.SETT.ALEG]”.

7 The Counterparty receives the following messages from T2S:

8 **Table 2-31: Messages from T2S [T2S.BPD.SETT.ECSD.15]**

Message Name	ISO Code	To/From T2S	Event	UDFS Chapter
SecuritiesSettlementTransactionAllegementNotificationV03	Sese.028.001.03	From T2S	No matching counterparty instruction exists	3.3.8.8

9 **2.3.3.3.13 Initiate T2S Settlement**

Reference ID	T2S.BPD.SETT.ECSD.16
--------------	----------------------

10 T2S Actors: Last CSD in T2S

11 The Last CSD in T2S (of the delivering or receiving settlement chain) initiates this process upon receipt of a
12 Settlement Allegement from T2S and/or settlement information from the settlement intermediaries
13 communicated outside T2S. The CSD prepares and sends settlement instruction to T2S on behalf of the
14 counterparty outside T2S.

15 The instruction of T2S is also possible via the T2S GUI.

16 References:

17 UDFS: Use Case “Send Settlement Instruction” (Chapter 2.3)

18 GUI BFD: T2S.GUI.SESE.INX.0070

19

1 **2.3.3.3.14 Manage Settlement Results**

Reference ID	T2S.BPD.SETT.ECSD.17
--------------	----------------------

2 T2S Actors: Last CSD in T2S

3 The Last CSD in T2S receives the T2S generated settlement instructions for realignment of the securities
 4 positions in its books. The Last CSD in the delivering (or receiving) chain in T2S must have defined CoSD
 5 rules. These CoSD rules are applicable for all the settlement instructions including the T2S generated
 6 settlement instructions belonging to the CSD.

7 The T2S generated realignment instructions owned by the Last CSD in T2S are subject to CoSD hold
 8 processing. Based on the CoSD processing condition, the Last CSD in T2S may receive status advices and/or
 9 confirmations for blocking of securities positions and/or cash balances.

10 The Last CSD in T2S stores T2S generated settlement instructions and may use them for instructing the
 11 settlement of securities positions with the counterparty (or counterparty’s intermediary) in the books of
 12 Issuer CSD. In addition, the CSD updates the T2S generated settlement instruction upon receipt of status
 13 updates and confirmations from T2S.

14 The delivering CSD (or receiving CSD) in T2S will act as the Last CSD in T2S in case the delivering CSD
 15 (or receiving CSD) has a direct link with the Issuer CSD outside T2S.

16 **2.3.3.3.15 Settle Trades Outside T2S**

Reference ID	T2S.BPD.SETT.ECSD.18
--------------	----------------------

17 T2S Actors: Last CSD in T2S

18 The Last CSD in T2S initiates the settlement outside T2S after receiving the realignment instructions on the
 19 technical account (i.e. the inter-CSD account) from T2S. The Last CSD in T2S creates and sends settlement
 20 instructions to the Issuer CSD (external to T2S) for settlement of securities positions with the counterparty
 21 (or counterparty’s intermediary) in the books of Issuer CSD.

22 For instructing the Issuer CSD, the Last CSD in T2S may use the information contained in the realignment
 23 instructions received from T2S or refer to information received from the delivering/receiving CSD.

24

1 **2.3.3.3.16 Release CoSD**

Reference ID	T2S.BPD.SETT.ECSD.19
--------------	----------------------

2 T2S Actors: Last CSD in T2S

3 The Last CSD in T2S acts as the Administering Party for the CoSD condition (defined by the CSD) and
 4 initiates this process after the fulfilment of an external settlement condition. The Administrating Party may
 5 release or cancel the realignment instruction on CoSD Hold.

6 **2.3.3.3.17 Realign Technical Accounts in T2S**

Reference ID	T2S.BPD.SETT.ECSD.20
--------------	----------------------

7 T2S Actors: Last CSD in T2S

8 The Last CSD in T2S process starts after the completion of securities settlement in T2S on the inter-CSD
 9 account in the Last CSD in T2S. The Last CSD in T2S creates and sends an already matched settlement
 10 instructions to move the securities from the inter-CSD account to the mirror account in case of securities
 11 positions delivered to a CSD outside T2S (or from mirror account to inter-CSD account in case of securities
 12 positions received by a CSD in T2S).

13 **2.3.3.3.18 Receive Settlement Instruction Copy**

Reference ID	T2S.BPD.SETT.ECSD.21
--------------	----------------------

14 T2S Actors: CSD Participant (Scenario A)/CSD (Scenario B)

15 The CSD Participant [CSD] receives a copy of the settlement instruction initiated by the CSD on securities
 16 account owned by the CSD Participant.

17 The CSD Participant [CSD] stores the CSD [CSD Participant] initiated settlement instruction (copy) and
 18 references the same upon receipt of status updates and confirmations from T2S.

19 The CSD Participant [CSD] receives the following messages from T2S:

20 **Table 2-32: Messages from T2S [T2S.BPD.SETT.ECSD.21]**

Message Name	ISO Code	To/From T2S	Event	UDFS Chapter
SecuritiesSettlementTransactionInstructionV03	Sese.023.001.03	From T2S	Party has subscribed to copy of the settlement instruction	3.3.8.4

21

1 **2.3.3.3.19 Receive Notification**

Reference ID	T2S.BPD.SETT.ECSD.22
--------------	----------------------

2 T2S Actors: Payment Bank and Central Bank

3 The Payment Bank and Central Bank receive a notification whenever a securities settlement instruction
 4 results in the debit or credit of one of their T2S dedicated cash accounts. If the cash posting has caused the
 5 T2S dedicated cash account to be lower than the floor or higher than the ceiling thresholds T2S sends a
 6 second notification message. The Payment Bank and Central Bank may conduct additional tasks such as
 7 updating cash registers of the Payment Bank/Central Bank and liquidity management activities (e.g. resulting
 8 in a transfer of cash from or to T2S).

9 The Payment Bank and Central Bank receive the following messages from T2S:

10 **Table 2-33: Messages from T2S [T2S.BPD.SETT.ECSD.22]**

Message Name	ISO Code	To/From T2S	Event	UDFS Chapter
BankToCustomerDebitCreditNotificationV03	Camt.054.001.03	From T2S	Debit or Credit of dedicated cash account	3.3.3.17
ReturnAccountV05	Camt.004.001.05	From T2S	Cash posting on the dedicated cash account overrides the floor/ceiling thresholds set-up for the dedicated cash account	3.3.3.2

3. SUPPORTING SETTLEMENT PROCESSES

Supporting Settlement Processes are processes which do not – by themselves – include the settlement of securities or cash, but which either facilitate settlement processes (e.g. administration of CoSD) or closely relate to them (e.g. cancellation of a settlement instruction).

3.1 MANAGEMENT OF ALLEGEMENT [T2S.BPD.SETT.ALEG]

3.1.1 OVERVIEW

This process describes the act of receiving and managing allegements as a consequence of a settlement instruction sent by the counterparty CSD or CSD Participant.

Settlement Allegement is used to inform a CSD Participant that its counterparty (another CSD Participant) has instructed against its account for which the CSD Participant has no corresponding instruction in T2S.

Allegement Removal and Cancellation of Settlement Allegement are used to inform a party that the Settlement Allegement received earlier by the CSD Participant is not valid any more. However, each of these messages is generated and sent by T2S due to different reasons.

- Allegement Removal is sent to a CSD Participant when T2S matches the settlement instruction that triggered the Settlement Allegement.
- Cancellation of Settlement Allegement is sent to a CSD Participant when the settlement instruction that triggered the Settlement Allegement has been cancelled by the counterparty or T2S.

Trigger:

The CSD or CSD Participant receives a Settlement Allegement because its counterparty CSD or CSD Participant's settlement instruction remains unmatched for a predefined period of time in T2S.

Preconditions:

None

T2S Instructing Party:

None

1 **3.1.2 BUSINESS PROCESS DIAGRAM**

2 **Figure 3-1: Business Process Diagram [T2S.BPD.SETT.ALEG]**

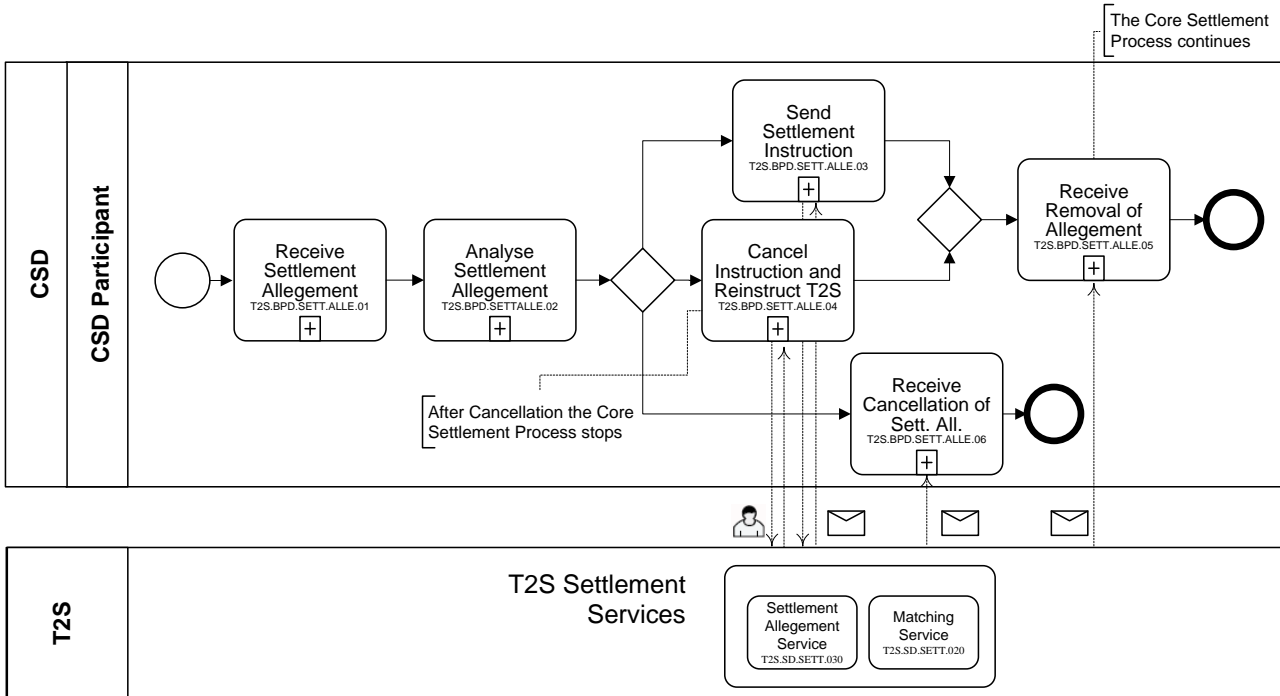

3

4 **3.1.3 BUSINESS PROCESS DESCRIPTION**

5 **3.1.3.1 INITIAL T2S PROCESSING**

6 After an unsuccessful matching attempt, the **Allegation Service (T2S SD.SETT.030)** waits for the missing
 7 counterparty instruction for a predetermined period of time before sending an allegation
 8 (SecuritiesSettlementTransactionAllegationNotificationV02) to the counterparty.

9 **3.1.3.2 RECEIVE SETTLEMENT ALLEGEMENT**

Reference ID	T2S.BPD.SETT.ALEG.01
--------------	----------------------

10 T2S Actors: CSD (Scenario A)/CSD Participant (Scenario B)

11 The CSD [CSD Participant] receives a Settlement Allegement if its counterparty instructed against an
 12 account of the CSD Participant and T2S could not match this settlement instruction against a settlement
 13 instruction of the CSD [CSD Participant] within a certain period of time after the first matching attempt. The
 14 Settlement Allegement carries information on the settlement instruction sent by the counterparty.

15 Instead of subscribing to individual allegation messages, the CSD [CSD Participant] could subscribe to the
 16 Statement of Settlement Allegements report. This report will include details of all transactions that
 17 counterparty has alleged against the CSD [CSD Participant] on a settlement day. The report can be generated

1 at a specific time or up on the occurrence of specific event(s). This report is available in complete and delta
 2 formats.

3 The CSD [CSD Participant] receives the following messages from T2S:

4 **Table 3-1: Messages and Report from T2S [T2S.BPD.SETT.ALEG.01]**

Message Name	ISO Code	To/From T2S	Event	UDFS Chapter
SecuritiesSettlementTransactionAllegationNotificationV03	Sese.028.001.03	From T2S	No matching counterparty instruction exists	3.3.8.8
SecuritiesSettlementTransactionAllegationReport	Semt.019.001.03	From T2S	Any event or time based trigger set by CSD Participant or CSD	3.3.7.8

5 References:

6 UDFS: Use Case “Send Settlement Instruction” (Chapter 2.3) and “Receive Report” (Chapter 2.19)

7 GUI BFD: T2S.GUI.SESE.ALG.0010, T2S.GUI.SESE.ALG.0020, T2S.GUI.SESE.ALG.0030

8 **3.1.3.3 ANALYSE SETTLEMENT ALLEGEMENT**

Reference ID	T2S.BPD.SETT.ALEG.02
--------------	----------------------

9 T2S Actors: CSD (Scenario A)/CSD Participant (Scenario B)

10 The CSD [CSD Participant] validates the Settlement Allegement against its unmatched settlement
 11 instructions previously sent to T2S. The CSD [CSD Participant]’s analysis may result in either of the
 12 following conclusions.

- 13 • The CSD [CSD Participant] does not find a settlement instruction that matches details included in the
 14 Settlement Allegement received.
- 15 • The CSD [CSD Participant] acknowledges that there is a business trade with the counterparty in its Back
 16 Office system. The CSD [CSD Participant] sends a new settlement instruction to T2S.
- 17 • The counterparty has incorrectly instructed. The CSD [CSD Participant] may consider contacting the
 18 counterparty outside T2S.
- 19 • The CSD [CSD Participant] identifies a settlement instruction with similar details that it previously
 20 instructed against the counterparty in T2S and
 - 21 ○ the CSD [CSD Participant] has sent an incorrect settlement instruction. The CSD Participant
 22 cancels the incorrect instruction and reinstructs,

- 1 ○ the counterparty has incorrectly instructed. The CSD [CSD Participant] may consider
- 2 contacting the counterparty outside T2S.

3 **3.1.3.3.1 Send Settlement Instruction**

Reference ID	T2S.BPD.SETT.ALEG.03
--------------	----------------------

4 T2S Actors: CSD (Scenario A)/CSD Participant (Scenario B)

5 The CSD [CSD Participant] initiates a new settlement instruction in response to a Settlement Allegement
 6 received because no settlement instruction is found in T2S that matches details included in the Settlement
 7 Allegement.

8 For details, refer to the core settlement processes e.g. “Intra-CSD Settlement [T2S.BPD.SETT.ICSD]”.

9 References:

10 UDFS: Use Case “Send Settlement Instruction” (Chapter 2.3)

11 GUI BFD: T2S.GUI.SESE.ALG.0010, T2S.GUI.SESE.ALG.0020, T2S.GUI.SESE.ALG.0030

12 **3.1.3.3.2 Cancel Instruction and Reinject T2S**

Reference ID	T2S.BPD.SETT.ALEG.04
--------------	----------------------

13 T2S Actors: CSD (Scenario A)/CSD Participant (Scenario B)

14 The CSD [CSD Participant] sends a cancellation instruction to T2S for the incorrectly instructed settlement
 15 instruction and a new settlement instruction with correct details to T2S.

16 For details on the cancellation of settlement instruction, refer to process “Cancellation of Settlement
 17 Instruction [T2S.BPD.SETT.CINS]”.

18 **3.1.3.3.3 T2S Processing**

19 As soon as the **Matching Service (T2S.SD.SETT.020)** succeeds in matching the instruction that was alleged
 20 previously, the **Allegement Service (T2S SD.SETT.030)** informs the alleged party
 21 (SecuritiesSettlementAllegementRemovalAdviceV02). In case that the alleged settlement instruction is
 22 cancelled, the alleged counterparty is informed as well (SecuritiesMessageCancellationAdviceV02).

23

1 **3.1.3.3.4 Receive Removal of Allegement**

Reference ID	T2S.BPD.SETT.ALEG.05
--------------	----------------------

2 T2S Actors: CSD (Scenario A)/CSD Participant (Scenario B)

3 The CSD [CSD Participant] receives an allegement removal signifying that the Settlement Allegement
 4 received earlier is not valid any longer. This happens, when T2S matches the counterparty’s settlement
 5 instruction that triggered the allegement.

6 The CSD [CSD Participant] receives the following message from T2S:

7 **Table 3-2: Messages and Report from T2S [T2S.BPD.SETT.ALEG.05]**

Message Name	ISO Code	To/From T2S	Event	UDFS Chapter
SecuritiesSettlementAllegementRemovalAdviceV03	Sese.029.001.03	From T2S	Settlement instruction that resulted in the generation of Settlement Allegement has matched	3.3.8.9

8 **3.1.3.3.5 Receive Cancellation of Settlement Allegement**

Reference ID	T2S.BPD.SETT.ALEG.06
--------------	----------------------

9 T2S Actors: CSD (Scenario A)/CSD Participant (Scenario B)

10 The CSD [CSD Participant] receives cancellation to Settlement Allegement signifying that the Settlement
 11 Allegement received earlier is not valid any longer. This happens, if the settlement instruction that had
 12 resulted in Settlement Allegement has been cancelled. The settlement instruction may be cancelled due to
 13 variety of reasons, either by the T2S actor or by T2S due to recycling or unsuccessful revalidation.

14 The CSD [CSD Participant] receives the following message from T2S:

15 **Table 3-3: Messages and Report from T2S [T2S.BPD.SETT.ALEG.06]**

Message Name	ISO Code	To/From T2S	Event	UDFS Chapter
SecuritiesMessageCancellationAdviceV02	Semt.020.001.02	From T2S	Settlement instruction that resulted in the generation of Settlement Allegement has been cancelled	3.3.7.8

16

1 **3.2 MANAGEMENT OF CSD VALIDATION HOLD [T2S.BPD.SETT.CSDH]**

2 **3.2.1 OVERVIEW**

3 This process describes the act of receiving a status advice for a settlement instruction specifying that T2S has
4 put the settlement instruction on CSD Validation Hold as a consequence of CSD specific requirements
5 related to securities settlement (e.g. registration and regulatory / market specific checks), and the
6 management of these requirements and their result.

7 The process involves analysing the status details of a settlement instruction in the Settlement Instruction
8 Status Advice for identification of CSD Validation Hold activation. The CSD may either release or cancel
9 the settlement instruction in CSD Validation Hold status depending upon the results of other business
10 processes. The CSD Validation Hold functionality does not prevent the settlement instructions from
11 matching. T2S will attempt the settlement of a matched instruction only after the CSD releases the
12 instruction put on CSD Validation Hold.

13 The CSD Validation Hold functionality is applicable to settlement instructions instructed by a CSD
14 Participant or CSD as well as T2S generated settlement instructions for realignments²⁰. This functionality
15 does not apply to settlement restrictions (i.e. intra-position and intra-balance movements).

16 **Trigger:**

17 The CSD receives a settlement instruction status advice in case T2S successfully validates a settlement
18 instruction and identifies that a CSD Validation Hold rule is applicable on the settlement instruction.

19 **Preconditions:**

20 The CSD must set-up the processing restrictions for CSD Validation Hold functionality in T2S reference
21 data.

22 **T2S Instructing Party:**

23 None

²⁰ T2S does not create any settlement instructions (includes settlement instructions for the purpose of realigning securities positions) for auto-collateralisation in case a CSD Validation Hold restriction rule applies on T2S generated settlement instructions.

1 **3.2.2 BUSINESS PROCESS DIAGRAM**

2 **Figure 3-2: Business Process Diagram [T2S.BPD.SETT.CVHD]**

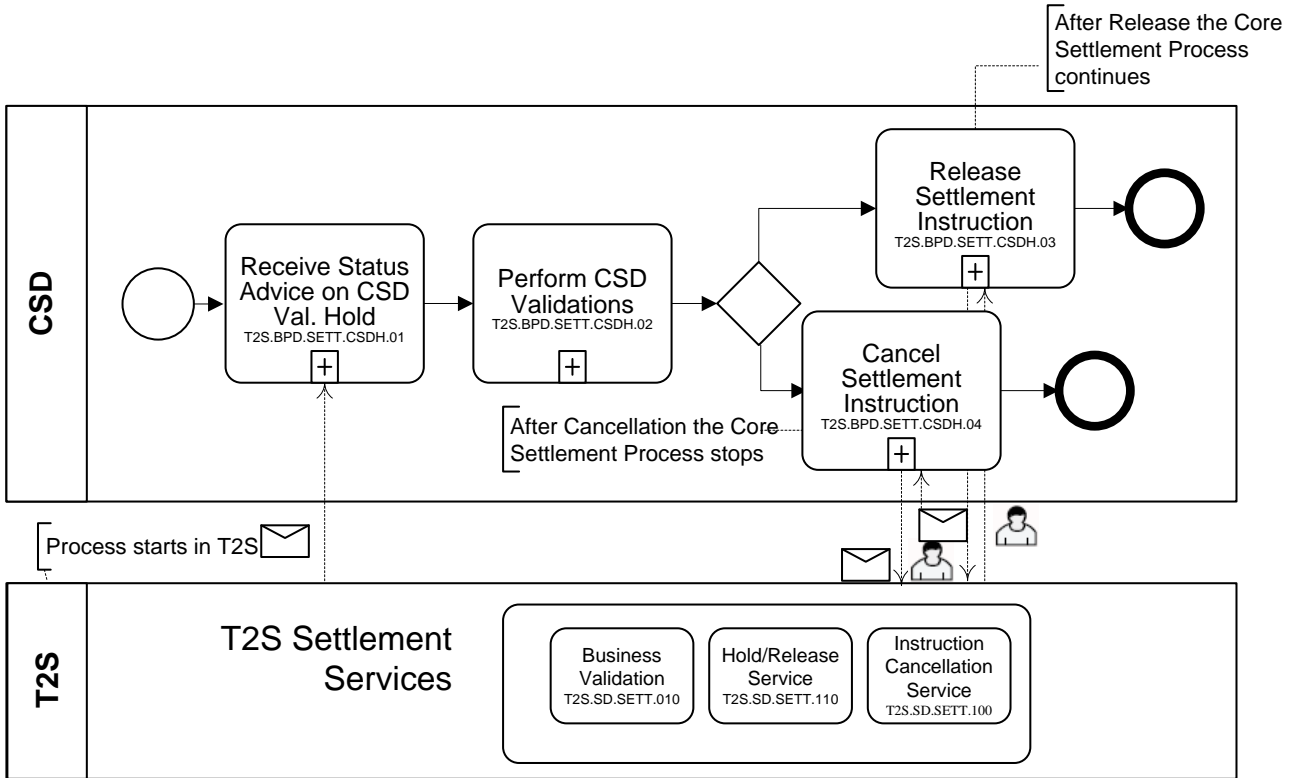

3

4 **3.2.3 BUSINESS PROCESS DESCRIPTION**

5 **3.2.3.1 INITIAL T2S PROCESSING**

6 The **Business Validation Service (T2S.SD.SETT.010)** validates the incoming settlement instruction. If the
 7 instruction fulfils any restriction previously defined by the CSD, the **Hold/Release Service (T2S**
 8 **SD.SETT.110)** puts it on CSD Validation Hold and informs the CSD
 9 (SecuritiesSettlementTransactionStatusAdviceV03).

10 **3.2.3.2 RECEIVE STATUS ADVICE ON CSD VALIDATION HOLD**

Reference ID	T2S.BPD.SETT.CSDH.01
--------------	----------------------

11 T2S Actors: CSD

12 The CSD receives the status advice message specifying that T2S has put a settlement instruction on CSD
 13 Validation Hold status. T2S checks the CSD Validation Hold applicability for a settlement instruction based
 14 on predefined conditions set by the CSD in the T2S reference data.

15 For details on the maintenance of CSD Validation Hold rules in T2S static data, see “Maintenance of
 16 Restrictions [T2S.BPD.STDA.MRES]”.

1 The CSD receives the following message from T2S:

2 **Table 3-4: Messages and Report from T2S [T2S.BPD.SETT.CSDH.01]**

Message Name	ISO Code	To/From T2S	Event	UDFS Chapter
SecuritiesSettlementTransactionStatusAdviceV03	Sese.024.001.03	From T2S	Change in status of settlement instruction	3.3.8.5

3 References:

4 UDFS: Use Case “Send Settlement Instruction” (Chapter 2.3)

5 **3.2.3.3 PERFORM CSD VALIDATIONS**

Reference ID	T2S.BPD.SETT.CSDH.02
--------------	----------------------

6 T2S Actors: CSD

7 The CSD analyses the settlement instruction on CSD Validation Hold and determines the additional checks
 8 and / or business processes to be completed before the settlement instruction can become eligible for a
 9 settlement attempt in T2S.

10 A non-exhaustive list of business scenarios wherein the CSD Validation Hold functionality might have been
 11 required are:

- 12 • business processes like registration of securities prior to securities settlement in T2S and tax processing,
- 13 • the CSD may need to validate settlement instructions prior to securities settlement in T2S in case the
 14 CSD Participant sends a settlement instruction directly to T2S.

15 **3.2.3.4 RELEASE SETTLEMENT INSTRUCTION**

Reference ID	T2S.BPD.SETT.CSDH.03
--------------	----------------------

16 T2S Actors: CSD

17 The CSD releases the settlement instruction on CSD Validation Hold in case the additional internal CSD
 18 validations are successful and the related business processes are completed successfully.

19 For details on the release of a settlement instruction, refer to process “Release of Settlement Instruction
 20 [T2S.BPD.SETT.RELE]”.

21

1 **3.2.3.5 CANCEL SETTLEMENT INSTRUCTION**

Reference ID	T2S.BPD.SETT.CSDH.04
--------------	----------------------

2 T2S Actors: CSD

3 The CSD cancels the settlement instruction on CSD Validation Hold in case the additional internal CSD
4 validations are not successful or the related business processes cannot be completed successfully²¹.

5 For details on the cancellation of a settlement instruction, refer to process “Cancellation of Settlement
6 Instruction [T2S.BPD.SETT.CINS]”.

7 References:

8 UDFS: Use Case “Send Cancellation Instruction for a Settlement Instruction (Chapter 2.11)

9 UDFS: Use Case “Send Hold/Release Instruction” (Chapter 2.10)

10 **3.2.3.6 T2S PROCESSING**

11 Once the CSD which had previously defined the rule sends the release instruction, the **Hold/Release Service**
12 **(T2S SD.SETT.110)** releases the message. In case the CSD sends a cancellation instruction, the **Instruction**
13 **Cancellation Service (T2S SD.SETT.100)** cancels the original settlement instruction. For details, refer to
14 processes “Release of Settlement Instruction [T2S.BPD.SETT.RELE]” and “Cancellation of Settlement
15 Instruction [T2S.BPD.SETT.CINS]”.

16

²¹ In case the settlement instruction on CSD Validation Hold process has matched, rules for bilateral cancellation will apply.

1 **3.3 ADMINISTRATION OF CONDITIONAL SECURITIES DELIVERY** 2 **[T2S.BPD.SETT.COSD]**

3 **3.3.1 OVERVIEW**

4 This process describes the act of administrating a Conditional Securities Delivery (CoSD) in T2S.
5 Conditional Securities Delivery (also called CoSD) process allows the CSD to handle exceptions wherein the
6 securities settlement is allowed to take place in T2S only upon fulfilment of a settlement condition outside
7 T2S. For example, free of payment settlement in T2S can be coordinated with cash settlement outside T2S
8 using the CoSD functionality.

9 T2S validates the settlement instruction for CoSD process on or after the intended settlement date of the
10 settlement instruction. To enable the identification of settlement instructions to be subject to CoSD process,
11 T2S allows the CSD to set-up CoSD rules in T2S static data. During the set-up of CoSD rules, the CSD also
12 specifies an Administering Party that monitors the CoSD process. T2S informs the Administering Party
13 about the details of settlement instruction put on CoSD Hold (as soon as CoSD Hold is activated) as well as
14 the successful blocking of securities and/or cash resources (as per the Administration Type). Administering
15 party may release or cancel the settlement instruction in T2S, depending on whether the external condition
16 could be completed or not.

17 For details on the set-up of CoSD parameters, refer to process “Maintenance of CoSD Parameters
18 [T2S.BPD.STDA.MCOS]”.

19 This process applies to intra-CSD as well as cross-CSD and external CSD settlement scenarios.

20 **Trigger:**

21 The Administering Party receives instruction details as a status advice, with the status as “CoSD Hold”

22 **Preconditions:**

23 None

24 **T2S Instructing Party:**

25 Administering Party

3.3.2 BUSINESS PROCESS DIAGRAM

Figure 3-3: Business Process Diagram [T2S.BPD.SETT.COSD]

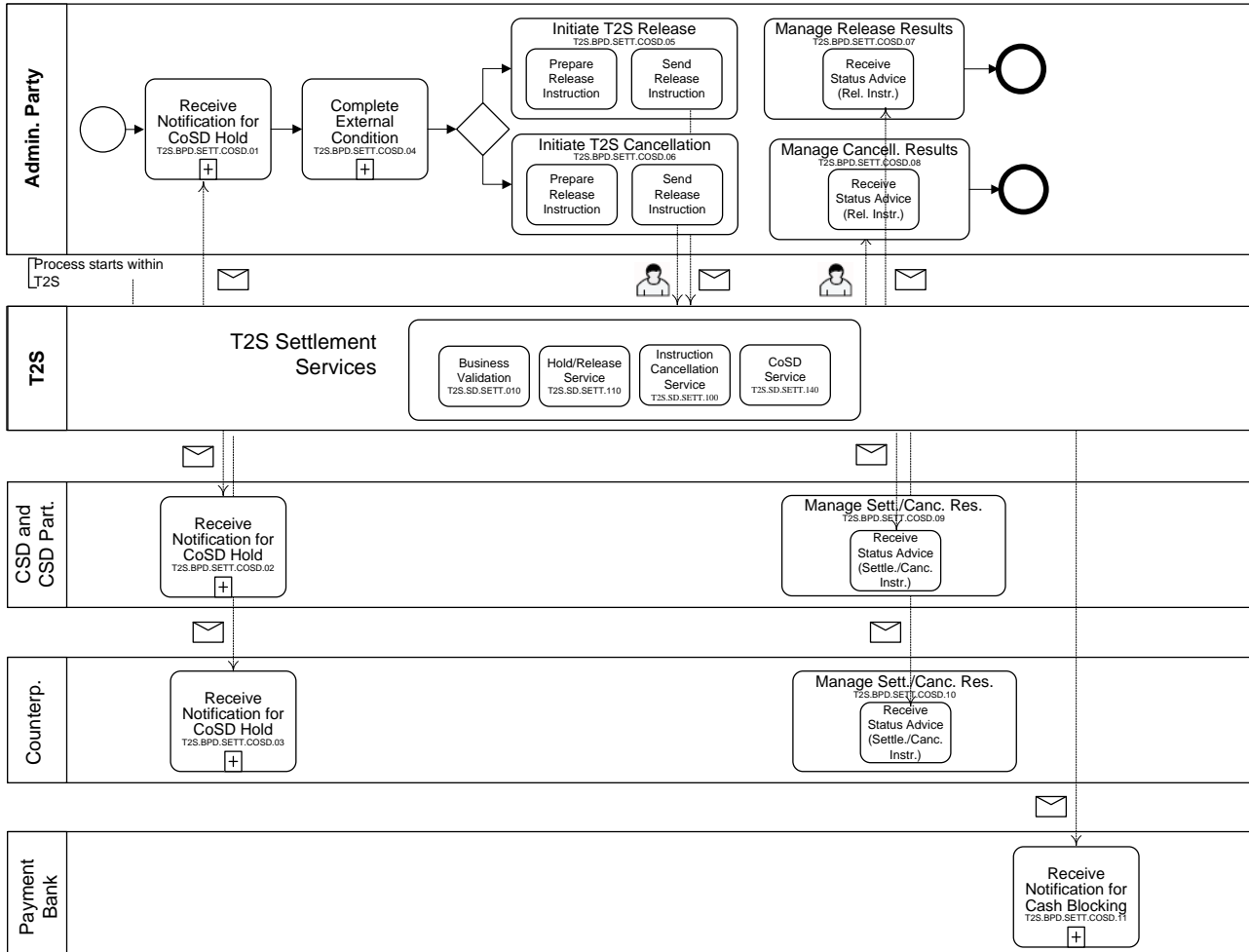

3.3.3 BUSINESS PROCESS DESCRIPTION

3.3.3.1 INITIAL T2S PROCESSING

On the intended settlement date the **Conditional Securities Delivery Service (T2S.SD.SETT.140)** validates all matched settlement instructions for fulfilment of CoSD rules previously defined. In case COSD rules apply it generates a “Hold” instruction and informs the parties (SecuritiesSettlementConditionModificationStatusAdviceV02). The “Hold” instruction is processed by the **Hold/Release Service (T2S.SD.SETT.110)** and the result communicated via a status advice (SecuritiesSettlementTransactionStatusAdviceV03). Depending on the CoSD rules set-up by the CSD, the **Earmarking, Blocking and Reservation Service (T2S.SD.SETT.120)** blocks the securities positions and/or cash related to the settlement instruction and sends out the corresponding status advices (IntraPositionMovementStatusAdviceV02 or IntraBalanceMovementStatusAdviceV02 as well as SecuritiesSettlementTransactionStatusAdviceV03). When a CoSD is activated for a Settlement Instruction

1 using restriction references, additional settlement instructions are generated and respective (additional) status
2 advices sent to the participants.

3 3.3.3.2 RECEIVE NOTIFICATION FOR COSD HOLD

Reference ID	T2S.BPD.SETT.COSD.01
--------------	----------------------

4 T2S Actors: Administering Party (as CSD Participant)

5 Based on the CoSD rules set-up by the CSD, T2S identifies a settlement instruction from the CSD
6 Participant as having a CoSD, generates a request for “CoSD Hold” and executes it.

7 As a result, the Administering Party receives status advice for settlement instruction, with the status as
8 “CoSD Hold”. The status advice contains the instruction details, including the instruction reference assigned
9 by the CSD. Using this reference Administering Party could liaise with the CSD for initiating completion of
10 the conditions external to T2S.

11 The Administering Party receives the below messages from T2S on the settlement date:

- 12 • the settlement instruction status advice with the status “CoSD Hold”,
- 13 • the status advice for the execution of the T2S generated “Hold” instruction.

14 Depending on the CoSD rules set-up by the CSD, T2S blocks the securities positions and/or cash related to
15 the settlement instruction.

16 For more details, refer to processes “Reservation or Blocking of Securities Position
17 [T2S.BPD.SETT.RBSP]” and “Reservation or Blocking of Cash Balance [T2S.BPD.SETT.RBCB]”.

18 The Administering party receives:

- 19 • the settlement instruction status advice with the reason as “CoSD awaiting from Administering Party”

20 When a CoSD is activated for a Settlement Instruction using restriction references, one or more additional
21 settlement instructions are generated by T2S, hence additional status advices are sent to the participants for
22 these settlement instructions.

23

1 The Administering Party receives the following messages from T2S:

2 **Table 3-5: Messages from T2S [T2S.BPD.SETT.COSD.01]**

Message Name	ISO Code	To/From T2S	Event	UDFS Chapter
SecuritiesSettlementTransactionStatusAdviceV03	Sese.024.001.03	From T2S	Instruction is kept on “CoSD Hold” in T2S/ the blocking of securities/cash is complete (“CoSD awaiting from Administering Party”)	3.3.8.5
SecuritiesSettlementConditionModificationStatusAdviceV03	Sese.031.001.03	From T2S	Execution of the T2S generated CoSD hold instruction	3.3.8.11

3 References:

4 UDFS: Use Case “Send settlement instruction” (Chapter 2.3)

5 **3.3.3.3 RECEIVE NOTIFICATION FOR COSD HOLD**

Reference ID	T2S.BPD.SETT.COSD.02
--------------	----------------------

6 T2S Actors: CSD and CSD Participant

7 Once T2S identifies the settlement instruction as having CoSD, the CSD and CSD Participant receive the
8 below messages from T2S:

- 9
- 10 • the settlement instruction status advice with the status “CoSD Hold”,
 - 11 • the settlement instruction status advice for the execution of the T2S generated “Hold” instruction.

12 Depending on the CoSD rules set-up by the CSD, T2S blocks the securities positions and/or cash related to
13 the settlement instruction. The CSD and CSD Participant receives:

- 14 • the confirmation messages for blocking of securities and/or cash,
- 15 • the status advice with reason code “CoSD awaiting from Administering Party”.

16 When a CoSD is activated for a Settlement Instruction using restriction references, one or more additional
17 settlement instructions are generated by T2S, hence additional status advices are sent to the participants for
18 these settlement instructions.

1 The CSD and CSD Participant receives the following messages from T2S:

2 **Table 3-6: Messages from T2S [T2S.BPD.SETT.COSD.02]**

Message Name	ISO Code	To/From T2S	Event	UDFS Chapter
SecuritiesSettlementTransactionStatusAdviceV03	Sese.024.001.03	From T2S	Settlement instruction is kept on CoSD hold in T2S/ the blocking of securities/cash is complete (“CoSD awaiting from Administering Party”)	3.3.8.5
SecuritiesSettlementConditionModificationStatusAdviceV03	Sese.031.001.03	From T2S	Execution of the T2S generated CoSD hold instruction	3.3.8.11
IntraPositionMovementStatusAdviceV03	Semt.014.001.03	From T2S	CoSD Blocking of securities positions is successful	3.3.7.3
IntraBalanceMovementStatusAdviceV02	Camt.067.001.01	From T2S	CoSD Blocking of cash amount is successful	3.3.3.21

3 References:

4 UDFS: Use Case “Send settlement instruction” (Chapter 2.3)

5 **3.3.3.4 RECEIVE NOTIFICATION FOR COSD HOLD**

Reference ID	T2S.BPD.SETT.COSD.03
--------------	----------------------

6 T2S Actors: Counterparty

7 Once T2S identifies the settlement instruction as having CoSD, the Counterparty receives the status advice
8 for its settlement instructing with a status as “Counterparty instruction on hold”.

9 When a CoSD is activated for a Settlement Instruction using restriction references, one or more additional
10 settlement instructions are generated by T2S, hence additional status advices are sent to the interested parties.

11

1 The Counterparty receives the following messages from T2S:

2 **Table 3-7: Messages from T2S [T2S.BPD.SETT.COSD.03]**

Message Name	ISO Code	To/From T2S	Event	UDFS Chapter
SecuritiesSettlementTransactionStatusAdviceV03	Sese.024.001.03	From T2S	CSD Participant’s instruction is on hold	3.3.8.5

3 References:

4 UDFS: Use Case “Send settlement instruction” (Chapter 2.3)

5 **3.3.3.5 COMPLETE EXTERNAL CONDITION**

Reference ID	T2S.BPD.SETT.COSD.04
--------------	----------------------

6 T2S Actors: Administering Party (as CSD Participant)

7 The Administering Party attempts to complete the external condition for the settlement instruction.

8 The remaining process flow depends upon the outcome of this sub-process: If the external condition is
 9 successfully completed, the Administering Party initiates the release of settlement instruction in T2S. If the
 10 external condition cannot be completed successfully, the Administering Party initiates the cancellation of
 11 settlement instruction in T2S.

12 **3.3.3.6 INITIATE T2S RELEASE**

Reference ID	T2S.BPD.SETT.COSD.05
--------------	----------------------

13 T2S Actors: Administering Party (as CSD Participant)

14 The Administering Party creates an instruction to release the “CoSD Hold” and enriches it with details
 15 required for settlement processing in T2S and sends the Release Instruction to T2S.

16 For details on the release of a settlement instruction, refer to process “Release of Settlement Instruction
 17 [T2S.BPD.SETT.RELE]”.

18 References:

19 UDFS: Use Case “Send Release Instruction for CoSD by Administering Party” (Chapter 2.6)

20 GUI BFD: T2S.GUI.SESE.INX.0060

21

1 **3.3.3.7 INITIATE T2S CANCELLATION**

Reference ID	T2S.BPD.SETT.COSD.06
--------------	----------------------

2 T2S Actors: Administering Party (as CSD Participant)

3 The Administering Party creates the Cancellation Instruction and sends it to T2S.

4 For details on the cancellation of a settlement instruction, refer to process “Cancellation of Settlement
5 Instruction [T2S.BPD.SETT.CINS]”.

6 References:

7 UDFS: Use Case “Send Cancellation Instruction for CoSD by Administering Party” (Chapter 2.7)

8 GUI BFD: T2S.GUI.SESE.INX.0050

9 **3.3.3.8 T2S PROCESSING**

10 Once the Administrating party sends the release instruction, the **Hold/Release service (T2S.SD.SETT.110)**
11 releases the settlement instruction. If the Administrating Party sends a cancellation instruction instead, the
12 **Instruction Cancellation Service (T2S SD.SETT.100)** cancels the original settlement instruction. For
13 details, refer to processes “Release of Settlement Instruction [T2S.BPD.SETT.RELE]” and “Cancellation of
14 Settlement Instruction [T2S.BPD.SETT.CINS]”.

15 **3.3.3.9 MANAGE RELEASE RESULTS**

Reference ID	T2S.BPD.SETT.COSD.07
--------------	----------------------

16 T2S Actors: Administering Party (as CSD Participant)

17 Administering party receives a status advice from T2S for execution of the release instruction.

18 For details on the messages received as a result of the release of a settlement instruction, refer to process
19 “Release of Settlement Instruction [T2S.BPD.SETT.RELE]”.

20 References:

21 UDFS: Use Case “Send Release Instruction for CoSD by Administering Party” (Chapter 2.6)

22 GUI BFD: T2S.GUI.SESE.INX.0060

23

1 **3.3.3.10 MANAGE CANCELLATION RESULTS**

Reference ID	T2S.BPD.SETT.COSD.08
--------------	----------------------

2 T2S Actors: Administering Party (as CSD Participant)

3 The Administering Party receives the status advice messages from T2S as a response to cancellation
4 Instruction.

5 In case, there are other administering parties for the same settlement instruction, and cancellation instructions
6 have not been received from all of them, then T2S does not inform the counterparty for a bilateral
7 cancellation request. T2S sends a status advice for the cancellation instruction to the Administering Party
8 specifying “CoSD cancellation pending from Administering Party”.

9 In case all the administering parties have already sent the cancellation instructions.

- 10 • If the Counterparty has sent the cancellation instruction to T2S already, then T2S sends:
- 11 ○ a status advice for the cancellation request with status as “executed” to all administering parties. T2S
 - 12 ○ cancels the settlement instruction and
 - 13 ○ a status advice to all administering parties, specifying that the cancellation is pending awaiting
 - 14 ○ confirmation from counter party.
- 15 • If the Counterparty has not sent the cancellation instruction to T2S already, then T2S sends a status
16 advice to the Counterparty, specifying that the other CSD Participant has requested for cancellation of
17 settlement instruction.

18 **Table 3-8: Messages from T2S [T2S.BPD.SETT.COSD.08]**

Message Name	ISO Code	To/From T2S	Event	UDFS Chapter
SecuritiesTransactionCancellationRequestStatusAdviceV03	sese.027.001.03	From T2S	Cancellation request from Administering Party is processed	3.3.8.7

19 References:

20 UDFS: Use Case “Send Cancellation Instruction for CoSD by Administering Party” (Chapter 2.7)

21 GUI BFD: T2S.GUI.SESE.INX.0050

22

1 **3.3.3.11 MANAGE SETTLEMENT RESULTS/CANCELLATION RESULTS**

Reference ID	T2S.BPD.SETT.COSD.09
--------------	----------------------

2 T2S Actors: CSD Participant and Counterparty

3 After the execution of the release request from Administering Party, T2S checks if there are still any other
 4 CoSD rules²² on the instruction. In case there are other CoSD rules, T2S sends a status advice, specifying the
 5 reason as “CoSD release rule, other rules remain” to the CSD Participant. Once all the CoSD rules are
 6 released, T2S sends a status advice specifying “no hold remains” to the CSD Participant and the
 7 Counterparty, who then initiate related internal processes.

8 In case the instruction is cancelled in T2S the CSD Participant and Counterparty receive the status advice
 9 messages generated by T2S for the cancellation of the settlement Instruction.

10 The CSD Participant and the Counterparty receive the following message from T2S:

11 **Table 3-9: Messages from T2S [T2S.BPD.SETT.COSD.09]**

Message Name	ISO Code	To/From T2S	Event	UDFS Chapter
SecuritiesSettlementTransactionStatusAdviceV03	Sese.024.001.03	From T2S	CoSD hold is released by one or all the administering parties/ Instruction is cancelled in T2S	3.3.8.5

12 References:

13 UDFS: Use Case “Send Release Instruction for CoSD by Administering Party” (Chapter 2.6), Use case
 14 “Send Cancellation Instruction for CoSD by Administering Party” (Chapter 2.7)

15 GUI BFD: T2S.GUI.SESE.INX.0010, T2S.GUI.SESE.INX.0020, T2S.GUI.SESE.INX.0030

16 **3.3.3.12 MANAGE SETTLEMENT RESULTS/CANCELLATION RESULTS**

Reference ID	T2S.BPD.SETT.COSD.10
--------------	----------------------

17 T2S Actors: Counterparty

18 In case the cancellation of instruction is initiated by all the administering parties, the Counterparty receives a
 19 cancellation allegation from T2S.

²² There could be more than one administering parties for a transaction, e.g. settlement of registered securities in a non-T2S currency may involve registrar (for ensuring completion of registration) and CSD (for ensuring the cash transfer has taken place).

1 Following a cancellation instruction from the Counterparty, the instruction is cancelled in T2S. The
 2 Counterparty receives the status advice message with the status as cancelled from T2S.

3 For details on the messages received as a result of the cancellation of a settlement instruction, refer to
 4 process “Cancellation of Settlement Instruction [T2S.BPD.SETT.CINS]”.

5 References:

6 UDFS: Use Case “Send Cancellation Instruction of a Settlement Instruction or a Settlement Restriction on
 7 Securities Position” (Chapter 2.11)

8 **3.3.3.13 RECEIVE NOTIFICATION FOR CASH BLOCKING**

Reference ID	T2S.BPD.SETT.COSD.11
--------------	----------------------

9 T2S Actors: Payment Bank

10 T2S completes the blocking of the cash amount, and informs the Payment Bank via a status advice message
 11 for intra-balance movement.

12 For details on the blocking of a cash balances, refer to process “Reservation or Blocking of Cash Balance
 13 [T2S.BPD.SETT.RBCB]”.

14 References:

15 UDFS: Use Case “Send Settlement Restriction on Cash Balance” (Chapter 2.5)

16

1 3.4 MANAGEMENT OF AUTO-COLLATERALISATION [T2S.BPD.SETT.ACOL]

2 3.4.1 OVERVIEW

3 This process describes the act of auto-collateralisation and reimbursement of auto-collateralisation in T2S.
4 Auto-collateralisation in T2S facilitates settlement of transactions that would not have settled otherwise due
5 to lack of cash or lack of securities. In case of lack of securities, auto-collateralisation tries to find
6 collateralised positions in the same ISIN; and initiates the automatic release of collateral and automatic
7 substitution in order to cover the lack. Auto-collateralisation can take place between Central Bank and
8 Payment Bank (Central Bank collateralisation), or between a Payment Bank and its clients (client
9 collateralisation). In case of Central Bank collateralisation, Central Bank must specify the collateralisation
10 procedure (as Repo, Pledge, or pledge-sub) in the configuration of Central Bank auto-collateralisation rules
11 (for details see BPD Maintenance of Auto-collateralisation Eligibility).

12 During the auto-collateralisation process T2S generates different settlement instructions, depending on the
13 collateralisation procedure.

- 14 • When the collateralisation procedure is Repo or pledge: T2S creates settlement instructions for auto-
15 collateralisation and reverse auto-collateralisation. In case of Repo, the generated instructions are DVPs.
16 In case of pledge, two PFODs and two FOPs are created. The auto-collateralisation instructions settle
17 along with the underlying settlement instruction that triggered auto-collateralisation. The reverse auto-
18 collateralisation instructions are put on hold in T2S, on the side of the Payment Bank (i.e. the collateral
19 giver in Central Bank collateralisation or the collateral taker in client collateralisation) until they are
20 released by the Payment Bank.
- 21 • When the collateralisation procedure is pledge-sub²³: T2S creates a settlement instruction for auto-
22 collateralisation as a payment free of delivery (PFOD) with quantity as zero. T2S also creates a
23 settlement restriction to move collateral from "earmarked for auto-collateralisation" position type into
24 the "collateralised" position type pledged to Central Bank within the Payment bank's securities account.
25 The settlement instruction and restriction settle along with the underlying settlement instruction that
26 triggered auto-collateralisation.
- 27 • For the reverse auto-collateralisation, T2S creates a settlement instruction (as PFOD) and a settlement
28 restriction to move the resources (cash amount, pledged securities) in the reverse direction of the auto-
29 collateralisation. The settlement instruction and settlement restriction are linked with the intent of
30 settling them together. The reverse auto-collateralisation instruction is put on hold.

²³ Pledge-sub is a type of auto-collateralisation, where securities are reserved in the account of the party receiving credit. In this case, the securities shall be reserved in favour of the party providing the credit.

1 The Payment Bank may initiate the reimbursement²⁴ of the auto-collateralisation by releasing the reverse
2 auto-collateralisation instructions in T2S. In certain scenarios, wherein the settlement instruction does not
3 settle in T2S due to lack of securities and there exist pending reverse auto-collateralisation instructions for
4 the same securities, T2S releases the pending reverse-auto-collateralisation instruction on behalf of the
5 Payment Bank (i.e. automatic substitution) to settle failing deliveries. In case the available cash or headroom
6 is sufficient to settle the reverse-auto-collateralisation, the intraday credit is reimbursed. Otherwise T2S
7 automatically initiates a new auto-collateralisation operation, in order to provide the necessary intraday
8 credit.

9 **Trigger:**

10 The Payment Bank (as CSD Participant) receives generation notification of auto-collateralisation and reverse
11 auto-collateralisation settlement instructions.

12 **Preconditions:**

13 Credit Memorandum Balance (CMB) must be set-up.

14 **T2S Instructing Party:**

15 Payment Bank (as CSD Participant)

²⁴ Central Bank collateralisation must be reimbursed on the same business day. T2S will automatically attempt settlement of pending reimbursement of Central Bank collateralisation at the end of the business day. The reimbursement of client collateralisation is up to the two parties and there is no automated procedure in T2S. The Payment Bank might need to adjust the limits for its clients during the start of the next business day to reflect the pending reverse collateralisation. Refer BPD 'Manage Limits'.

1 **3.4.2 BUSINESS PROCESS DIAGRAM**

2 **Figure 3-4: Business Process Diagram [T2S.BPD.SETT.ACOL]**

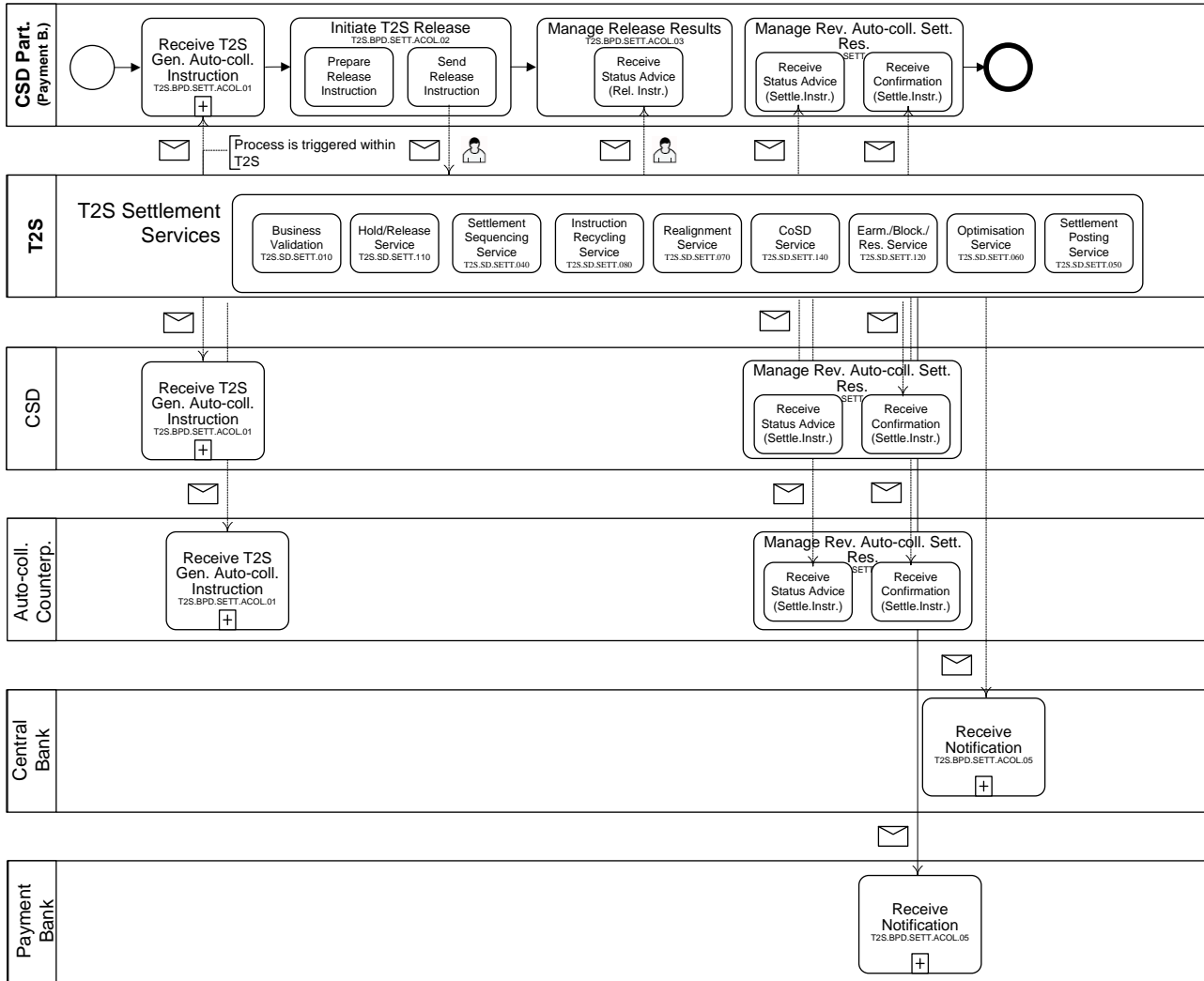

- 3
- 4 The Auto-collateralisation counterparty is,
- 5 • Central Bank in case of Central Bank collateralisation
- 6 • The client of the Payment Bank in case of client collateralisation.

7 **3.4.3 BUSINESS PROCESS DESCRIPTION**

8 **3.4.3.1 INITIAL T2S PROCESSING**

9 In case that a lack of cash or securities is detected, the **Optimisation Service (T2S.SD.SETT.060)** attempts

10 to resolve this lack of resources using auto-collateralisation. If auto-collateralisation can resolve the lack of

11 securities and/or cash, the service creates the necessary instructions for the auto-collateralisation and informs

12 the relevant parties (SecuritiesSettlementTransactionGenerationNotificationV02). These instructions are

13 subject to the normal settlement processing and the relevant parties receive a confirmation after settlement

1 (SecuritiesSettlementTransactionConfirmationV03 and IntraPositionMovementConfirmationV02). In
 2 addition to the auto-collateralisation instruction, the service creates the reverse auto-collateralisation
 3 settlement instruction as well (SecuritiesSettlementTransactionGenerationNotificationV02).

4 **3.4.3.2 RECEIVE T2S GENERATED AUTO-COLLATERALISATION INSTRUCTION**

Reference ID	T2S.BPD.SETT.ACOL.01
--------------	----------------------

5 T2S Actors: Payment Bank (as CSD Participant), CSD, Auto-Collateralisation Counterparty

6 When T2S settles an instruction using the auto-collateralisation, the Payment Bank (as CSD Participant),
 7 CSD and Auto-Collateralisation Counterparty receive notifications related to auto-collateralisation from
 8 T2S:

- 9 • Notification of the generation of auto-collateralisation Settlement Instruction²⁵,
- 10 • Confirmation of the full settlement of the generated auto-collateralisation Settlement Instruction,
- 11 • Notification of the generation of reverse auto-collateralisation Settlement Instruction. The generation
 12 notification for settlement instructions received by Payment Bank specifies that the instruction is put on
 13 “Party Hold”.

14 When the auto-collateralisation procedure is pledge-sub, the Payment Bank (as CSD Participant), CSD and
 15 Auto-Collateralisation Counterparty additionally receive the following messages:

- 16 • Settlement confirmation of the intra position movement related to the auto-collateralisation,
- 17 • Intra position movement status advice related to the reverse auto-collateralisation.

18 The Payment Bank (as CSD Participant), CSD and Auto-Collateralisation Counterparty receive the following
 19 messages from T2S:

20 **Table 3-10: Messages to T2S [T2S.BPD.SETT.ACOL.01]**

Message Name	ISO Code	To/From T2S	Event	UDFS Chapter
SecuritiesSettlementTransactionGenerationNotificationV03	Sese.032.001.03	From T2S	Generation of settlement instructions by T2S due to auto-collateralisation, reverse auto-collateralisation	3.3.8.12

²⁵ The auto-collateralisation process may involve usage of cross CSD securities. In such a scenario, T2S will create realignment instructions (see BPD Cross CSD Settlements).

Message Name	ISO Code	To/From T2S	Event	UDFS Chapter
SecuritiesSettlementTransactionConfirmationV03	Sese.025.001.03	From T2S	Full settlement of the auto-collateralisation instruction	3.3.8.6
IntraPositionMovementConfirmationV03	semt.015.001.03	From T2S	Auto-collateralisation (Pledge-sub) instruction is settled	3.3.7.4
IntraPositionMovementStatusAdviceV03	semt.014.001.03	From T2S	Reverse auto-collateralisation (Pledge-sub) instruction is generated by T2S, and is pending due to “eligibility failure”	3.3.7.3

- 1 References:
- 2 UDFS: Use Case “Send settlement Instruction” (Chapter 2.3)
- 3 GUI BFD: T2S.GUI.SESE.INX.0010

4 **3.4.3.3 INITIATE T2S RELEASE**

Reference ID	T2S.BPD.SETT.ACOL.02
--------------	----------------------

- 5 T2S Actors: Payment Bank (as CSD Participant)
- 6 The Payment Bank (as CSD Participant) initiates reimbursement of auto-collateralisation when it identifies a
- 7 need.
- 8 The Payment Bank (as CSD Participant) creates release Instruction²⁶ and enriches it with details required for
- 9 settlement processing in T2S and sends the Release Instruction to T2S.
- 10 For details on the release of a settlement instruction, refer to process “Release of Settlement Instruction
- 11 [T2S.BPD.SETT.RELE]”.

12 **3.4.3.3.1 Prepare Release instruction**

Reference ID	T2S.BPD.SETT.ACOL.02.01
--------------	-------------------------

- 13 The Payment Bank (as CSD Participant) creates the Release Instruction which includes T2S specific
- 14 information such as the reference of the reverse-auto-collateralisation settlement instruction to be released,
- 15 T2S securities account number and the type of Release to be applied (as Party hold).

²⁶ In case of pledge-sub collateralisation procedure, Payment bank releases the PFOD instruction. The linked settlement restriction settles along with the PFOD instruction.

1 **3.4.3.3.2 Send Instruction to T2S**

Reference ID	T2S.BPD.SETT.ACOL.02.02
--------------	-------------------------

2 The Payment Bank (as CSD Participant) converts the Release Instruction enriched with T2S specific
 3 information into the required message format and transmits it to T2S.

4 The instruction of T2S is also possible via the T2S GUI.

5 The Payment Bank (as CSD Participant) sends the following message to T2S:

6 **Table 3-11: Messages to T2S [T2S.BPD.SETT.ACOL.02.02]**

Message Name	ISO Code	To/From T2S	UDFS Chapter
SecuritiesSettlementConditionModificationRequestV03	sese.030.001.03	To T2S	3.3.8.10

7 **3.4.3.4 T2S PROCESSING**

8 Once the Payment Bank (as CSD Participant) sends the release instruction, the **Hold/Release Service**
 9 **(T2S.SD.SETT.110)** releases the reverse auto-collateralisation settlement instruction. For details, refer to
 10 process “Release of Settlement Instruction [T2S.BPD.SETT.RELE]”.

11 **3.4.3.5 MANAGE RELEASE RESULTS**

Reference ID	T2S.BPD.SETT.ACOL.03
--------------	----------------------

12 T2S Actors: Payment Bank (as CSD Participant)

13 The Payment Bank (as CSD Participant) receives status advice messages for the release instruction from T2S
 14 and initiates related internal processes.

15 If T2S has been instructed via the T2S GUI the status is shown on the screen.

16 For details on the release of a settlement instruction, refer to process “Release of Settlement Instruction
 17 [T2S.BPD.SETT.RELE]”.

18 **Table 3-12: Messages from T2S [T2S.BPD.SETT.ACOL.03]**

Message Name	ISO Code	To/From T2S	Event	UDFS Chapter
SecuritiesSettlementConditionModificationStatusAdviceV03	Sese.031.001.03	From T2S	Release instruction is rejected/ accepted/ denied by T2S	3.3.8.11

1 **3.4.3.6 MANAGE REVERSE AUTO-COLLATERALISATION SETTLEMENT RESULTS**

Reference ID	T2S.BPD.SETT.ACOL.04
--------------	----------------------

2 T2S Actors: Payment Bank (as CSD Participant), CSD, Auto-collateralisation Counterparty

3 The Payment Bank (as CSD Participant), CSD and Auto-collateralisation Counterparty receive settlement
4 related messages from T2S and initiate related internal processes.

5 **3.4.3.6.1 Receive Status Advice**

Reference ID	T2S.BPD.SETT.ACOL.04.01
--------------	-------------------------

6 The Payment Bank (as CSD Participant), CSD and Auto-collateralisation Counterparty receives status advice
7 messages for every status change or reason code update to the reverse auto-collateralisation instructions/ T2S
8 generated instructions in T2S.

9 The Payment Bank (as CSD Participant), CSD and Auto-collateralisation Counterparty receive the following
10 message from T2S:

11 **Table 3-13: Messages from T2S [T2S.BPD.SETT.ACOL.04.01]**

Message Name	ISO Code	To/From T2S	Event	UDFS Chapter
SecuritiesSettlementTransactionStatusAdviceV03	Sese.024.001.03	From T2S	Change in status of reverse auto-collateralisation instruction/ T2S generated instruction	3.3.8.5

12 **3.4.3.6.2 Receive Confirmation**

Reference ID	T2S.BPD.SETT.ACOL.04.02
--------------	-------------------------

13 The Payment Bank (as CSD Participant), CSD and Auto-collateralisation Counterparty receive and validate
14 settlement confirmation messages for the reverse auto-collateralisation instructions and the T2S generated
15 settlement instructions.

16

1 The Payment Bank (as CSD Participant), CSD and Auto-collateralisation Counterparty receive the following
 2 message from T2S:

3 **Table 3-14: Messages from T2S [T2S.BPD.SETT.ACOL.04.02]**

Message Name	ISO Code	To/From T2S	Event	UDFS Chapter
SecuritiesSettlementTransactionConfirmationV03	Sese.025.001.03	From T2S	Full settlement of the settlement instruction	3.3.8.6

4 **3.4.3.7 RECEIVE NOTIFICATION**

Reference ID	T2S.BPD.SETT.ACOL.05
--------------	----------------------

5 T2S Actors: Payment Bank, Central Bank

6 The settlement of auto-collateralisation instruction, reverse auto-collateralisation instruction results in the
 7 debit or credit of one of the T2S dedicated cash accounts of Payment bank and Central Bank. As a result of
 8 this, the Payment Bank and Central Bank receives a notification from T2S for the cash postings. If the cash
 9 posting has resulted in the cash amount in the T2S dedicated cash account being less than the floor threshold
 10 or more than the ceiling threshold, T2S sends a second notification message.

11 The Payment Bank and Central Bank may conduct additional tasks such as updating cash registers of the
 12 Payment Bank and Central Bank and liquidity management activities (e.g. resulting in a transfer of cash from
 13 or to T2S).

14 The Payment Bank and Central Bank receive the following messages from T2S:

15 **Table 3-15: Messages from T2S [T2S.BPD.SETT.ACOL.05]**

Message Name	ISO Code	To/From T2S	Event	UDFS Chapter
BankToCustomerDebitCreditNotificationV03	Camt.054.001.03	From T2S	Debit or Credit on T2S dedicated cash account	3.3.3.17
ReturnAccountV05	Camt.004.001.05	From T2S	Cash balance after the posting on the dedicated cash account is below the floor or above the ceiling thresholds set-up for the dedicated cash account	3.3.3.2

1 3.5 RESERVATION OR BLOCKING OF SECURITIES POSITION 2 [T2S.BPD.SETT.RBSP]

3 3.5.1 OVERVIEW

4 This process describes the act of reserving or blocking a certain quantity of securities within a securities
5 account. The CSD or CSD Participant (if directly connected) may reserve or block a securities position for
6 the purpose of ensuring the settlement of a particular settlement instruction in the future, or to prevent the use
7 of specific securities for settlement in order to perform a process (e.g. corporate action). The process of
8 reserving or blocking a securities position results in a transfer from one securities position into another one.

- 9 • Blocking is a process which prevents the transfer of a specified quantity of a security in one securities
10 account to any other securities account by associating it to a specific transaction or specific purpose.
11 Blocking in T2S may never result in a negative position. A blocking instruction is never partially
12 executed. The settlement of a settlement instruction using blocked securities results in the actual transfer
13 of the blocked holdings to another securities account and in the subsequent removal of the blocking.
- 14 • Reservation is a process, which prevents the transfer of a securities position in a specific security in one
15 securities account to any other securities account except for the purpose for which the position was
16 reserved. The settlement of a settlement instruction using reserved securities results in the actual transfer
17 of the reserved holdings to another securities account and in the subsequent removal of the reservation. It
18 is possible to reserve a position greater than the securities position on the securities account (pre-emption
19 mechanism).

20 For details on the unreservation or unblocking of a securities position refer to process “Unreservation or
21 Unblocking of Securities Position [T2S.BPD.SETT.UUSP]”.

22 For details on the restriction of static data objects (e.g. securities accounts), refer to section “Static Data
23 Restriction Processes”.

24 **Trigger:**

25 The CSD or CSD Participant receives details for reserving or blocking the securities position

26 **Preconditions:**

- 27 • Securities account containing the securities position to be reserved or blocked is known.
- 28 • Blocking or reservation restriction reference is known, when an existing blocking or reservation should
29 be increased²⁷.
- 30 • The restriction type Id that are referenced are known (set-up by the CSD or the T2S Operator).

²⁷ The restriction reference is used also for decrease. This part is covered in the variation of this BPD.

1 **T2S Instructing Party:**

2 There are two scenarios for the instruction of T2S:

- 3 • Scenario A: CSD instructs T2S.
 4 • Scenario B: CSD Participant instructs T2S.

5 **3.5.2 BUSINESS PROCESS DIAGRAM**

6 **Figure 3-5: Business Process Diagram [T2S.BPD.SETT.RBSP]**

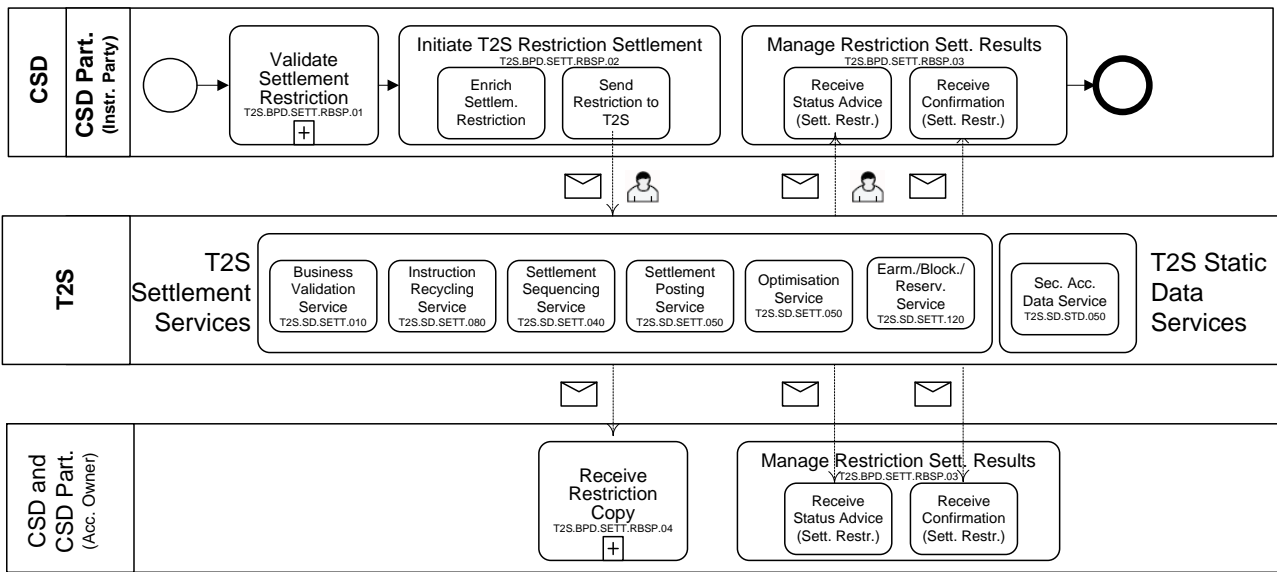

7
 8 **3.5.3 BUSINESS PROCESS DESCRIPTION**

9 This Business Process Description is applicable to Scenario A and B unless otherwise noted. For the purpose
 10 of readability, the actor names in the text refer to Scenario A with the Scenario B actor indicated in square
 11 brackets.

12 **3.5.3.1 VALIDATE SETTLEMENT RESTRICTION**

Reference ID	T2S.BPD.SETT.RBSP.01
--------------	----------------------

13 T2S Actors: CSD (Scenario A)/CSD Participant (Scenario B)

14 The CSD [CSD Participant] checks all the details in the settlement restriction on securities position against
 15 the reference data (maintained by the CSD or CSD Participant if directly connected).

16 **3.5.3.2 INITIATE T2S RESTRICTION SETTLEMENT**

Reference ID	T2S.BPD.SETT.RBSP.02
--------------	----------------------

17 T2S Actors: CSD (Scenario A)/CSD Participant (Scenario B)

1 The CSD [CSD Participant] enriches the settlement restriction on securities position with details required for
 2 settlement processing in T2S and sends the settlement restriction on securities position to T2S.

3 References:

4 UDFS: Use Case „Send Settlement Restriction on Securities position“(Chapter 2.4)

5 GUI BFD: T2S.GUI.SESE.INX.0070

6 **3.5.3.2.1 Enrich Settlement Restriction**

Reference ID	T2S.BPD.SETT.RBSP.02.01
--------------	-------------------------

7 The CSD [CSD Participant] enriches the settlement restriction on securities position with T2S specific
 8 information such as securities account reference²⁸, quantity of securities to be blocked or reserved, ISIN. The
 9 balance “From” and balance “To” need to be filled with the restriction type Id already defined by the T2S
 10 Operator or the CSD.

- 11 • In the balance “From”, the allowed Restriction type Ids are the ones pertaining to “Deliverable”,
 12 “earmarking” or “earmarking for auto-collateralisation” processing types.
- 13 • In the balance “To”, the allowed Restriction type Ids are the ones pertaining to the “Blocking” or
 14 “Reservation” processing types.

15 In case the CSD [CSD Participant] specifies a restriction reference²⁹, the blocked or reserved securities
 16 position referred to in the balance “To” will be increased. If not, a new restricted securities position will be
 17 created. It is possible to create multiple restriction references (i.e. bucket of securities) under the same
 18 restriction type Id. Also one restriction reference can be increased, decreased, used several times.

²⁸ It is possible to block or reserve securities in an earmarked securities account. The balance From of the blocking or reservation instruction should contain the restriction type Id that was used to earmark the securities account.

²⁹ This restriction reference was provided in the confirmation of the set-up of the blocked or reserved securities position.

1 **Figure 3-6: Enrich Settlement Restriction [T2S.BPD.SETT.RBSP.02.01]**

Blocking	Set-up		Increase	
Balance FROM	“Deliverable”	“Earmarking”	“Deliverable”	“Earmarking”
Balance TO	“Blocking”	“Blocking”	“Blocking”	“Blocking”
Restriction reference	Empty	Empty	REFXXX	REFXXX
Reservation	Set-up		Increase	
Balance FROM	“Deliverable”	“Earmarking”	“Deliverable”	“Earmarking”
Balance TO	“Reservation”	“Reservation”	“Reservation”	“Reservation”
Restriction reference	Empty	Empty	REFXXX	REFXXX

2

3 **3.5.3.2.2 Send Restriction to T2S**

Reference ID	T2S.BPD.SETT.RBSP.02.02
--------------	-------------------------

4 The CSD [CSD Participant] converts the enriched settlement restriction message on securities position
 5 enriched with T2S specific information into the required message format and transmits it to T2S.

6 The instruction of T2S is also possible via the T2S GUI.

7 The CSD [CSD Participant] sends the following message to T2S:

8 **Table 3-16: Messages to T2S [T2S.BPD.SETT.RBSP.02.02]**

Message Name	ISO Code	To/From T2S	UDFS Chapter
IntraPositionMovementInstruction	semt.013.001.03	To T2S	3.3.7.2

9 **3.5.3.3 T2S PROCESSING**

10 The **Business Validation Service (T2S.SD.SETT.010)** validates the received Intra-Position Movement
 11 Instruction. After successful validation the **Earmarking, Blocking and Reservation Service**
 12 **(T2S.SD.SETT.120)** executes the blocking or the reservation of the securities position and informs the
 13 relevant parties (IntraPositionMovementStatusAdvice and IntraPositionMovementConfirmation).

14 The further processing of the Intra-Position Movement Instruction follows the settlement lifecycle of a
 15 settlement instruction and involves the **Settlement Sequencing Service (T2S.SD.SETT.040)**, **Settlement**
 16 **Posting Service (T2S.SD.SETT.050)**, **Optimisation Service (T2S.SD.SETT.060)** and **Instruction**

1 **recycling Service (T2S.SD.SETT.080)**. For details on these T2S services, refer to process “Intra-CSD
2 Settlement [T2S.BPD.SETT.ICSD]”.

3 **3.5.3.4 MANAGE RESTRICTION SETTLEMENT RESULTS**

Reference ID	T2S.BPD.SETT.RBSP.03
--------------	----------------------

4 T2S Actors: CSD and CSD Participant (both scenarios)

5 The CSD and CSD Participant receive the settlement related messages from T2S and initiate related internal
6 processes.

7 In both scenarios, the CSD and the CSD Participant receive the messages. When a CSD instructs T2S
8 (Scenario A), the CSD Participant (if directly connected) can also receive these messages. Similarly, when
9 the CSD Participant instructs T2S (Scenario B), the CSD can also receive the messages.

10 References:

11 UDFS: Use Case “Send Settlement Restriction on Securities position” (Chapter 2.4)

12 GUI BFD: T2S.GUI.SESE.INX.0070, T2S.GUI.SESE.INX.0010, T2S.GUI.SESE.INX.0020,
13 T2S.GUI.SESE.INX.0030

14 **3.5.3.4.1 Receive Status Advice (Settlement Restriction)**

Reference ID	T2S.BPD.SETT.RBSP.03.01
--------------	-------------------------

15 The CSD and CSD Participant can receive status advices notifying of

- 16 • rejection of the settlement restriction on securities position,
- 17 • acceptance of the settlement restriction on securities position,
- 18 • eligibility failure of the settlement restriction on securities position,
- 19 • provision check failure of the settlement restriction on securities position,
- 20 • the remaining to be settled quantity of a reservation that has partially settled,
- 21 • a pending status for blocking.

22 If T2S has been instructed via the T2S GUI the status is shown on the screen.

23 Following the message reception, other internal activities might be conducted such as:

- 24 • aligning the status of the settlement restriction on securities position in the CSD’s or CSD Participant’s
25 systems with the status in T2S,
- 26 • triggering notification to CSD Participants if the CSD instructed on their behalf,

- 1 • analysing the failed instruction or a failed provision check.
- 2 The CSD and CSD Participant receive the following messages from T2S:

3 **Table 3-17: Messages from T2S [T2S.BPD.SETT.RBSP.03.01]**

Message Name	ISO Code	To/From T2S	Event	UDFS Chapter
IntraPositionMovementStatusAdvice	semt.014.001.03	From T2S	Positive or failed business validation, Eligibility failure, Intra-day restriction, Provision check failure	3.3.7.3

4 **3.5.3.4.2 Receive Confirmation (Settlement Restriction)**

Reference ID	T2S.BPD.SETT.RBSP.03.02
--------------	-------------------------

5 The CSD and CSD Participant receive:

- 6 • in the case of blocking from T2S: one settlement confirmation indicating the settlement status (i.e. full settlement),
- 7
- 8 • in the case of reservation from T2S: one or more (due to pre-emption) settlement confirmations
- 9 indicating the settlement status (i.e. full, partial or last partial settlement).

10 Following the message reception, other internal activities might be conducted such as:

- 11 • aligning the status of the settlement restriction on securities position in the CSD’s or CSD Participant’s
- 12 systems with the status in T2S,
- 13 • initiating actions in case of partial settlement of the restriction,
- 14 • triggering notification to CSD Participants in case the CSD instructed on their behalf,
- 15 • storing the restriction reference transmitted by T2S for later use, increase, decrease of the
- 16 blocked/reserved securities position.

17

1 The CSD and CSD Participant receive the following messages from T2S:

2 **Table 3-18: Messages from T2S [T2S.BPD.SETT.RBSP.03.02]**

Message Name	ISO Code	To/From T2S	Event	UDFS Chapter
IntraPositionMovementConfirmation	semt.015.001.03	From T2S	The restriction for blocking or reservation has fully settled, the last partial settlement of a reservation has occurred, the partial settlement of a reservation is confirmed (not the last)	3.3.7.4

3 **3.5.3.5 RECEIVE RESTRICTION COPY**

Reference ID	T2S.BPD.SETT.RBSP.04.
--------------	-----------------------

4 T2S Actors: CSD Participant (Scenario A)/CSD (Scenario B)

5 The CSD Participant [CSD] receives the copy of the inbound settlement restriction on securities position
 6 after it has been validated by T2S. The CSD Participant [CSD] initiates the relevant internal processes.

7 The CSD Participant [CSD] receives the following message from T2S:

8 **Table 3-19: Messages from T2S [T2S.BPD.SETT.RBSP.04]**

Message Name	ISO Code	To/From T2S	Event	UDFS Chapter
IntraPositionMovementInstruction	semt.013.001.03	From T2S	After validation of inbound blocking or reservation instruction	3.3.7.2

9

1 3.6 UNRESERVATION OR UNBLOCKING OF SECURITIES POSITION 2 [T2S.BPD.SETT.UUSP]

3 3.6.1 OVERVIEW

4 This process describes the act of unreserving or unblocking a certain quantity of securities within a securities
5 account. It results in a transfer from one restricted securities position into an available one. Instructing party
6 may free some securities in order to make them available for settlement.

7 It is to be noted that a restriction reference can be set to zero and reused later for further increases.

8 For details on the restriction of static data objects (e.g. securities accounts), refer to section “Static Data
9 Restriction Processes”.

10 This process is a variation of the process “Reservation or Blocking of Securities Position
11 [T2S.BPD.SETT.RBSP]”. The steps highlighted in the diagram below require particular attention.

12 **Trigger:**

13 The CSD or CSD Participant needs to unblock or unreserve the securities position

14 **Preconditions:**

- 15 • Securities account containing the securities position to be unreserved or unblocked is known.
- 16 • Blocking or reservation restriction reference in T2S is known.
- 17 • The restriction type Id that are referenced are known (set-up by the CSD or the T2S operator.) and are
18 valid.

19 **T2S Instructing Party:**

20 There are two scenarios for the instruction of T2S:

- 21 • Scenario A: CSD instructs T2S.
- 22 • Scenario B: CSD Participant instructs T2S.

1 **3.6.2 BUSINESS PROCESS DIAGRAM**

2 **Figure 3-7: Business Process Diagram [T2S.BPD.SETT.UUSP]**

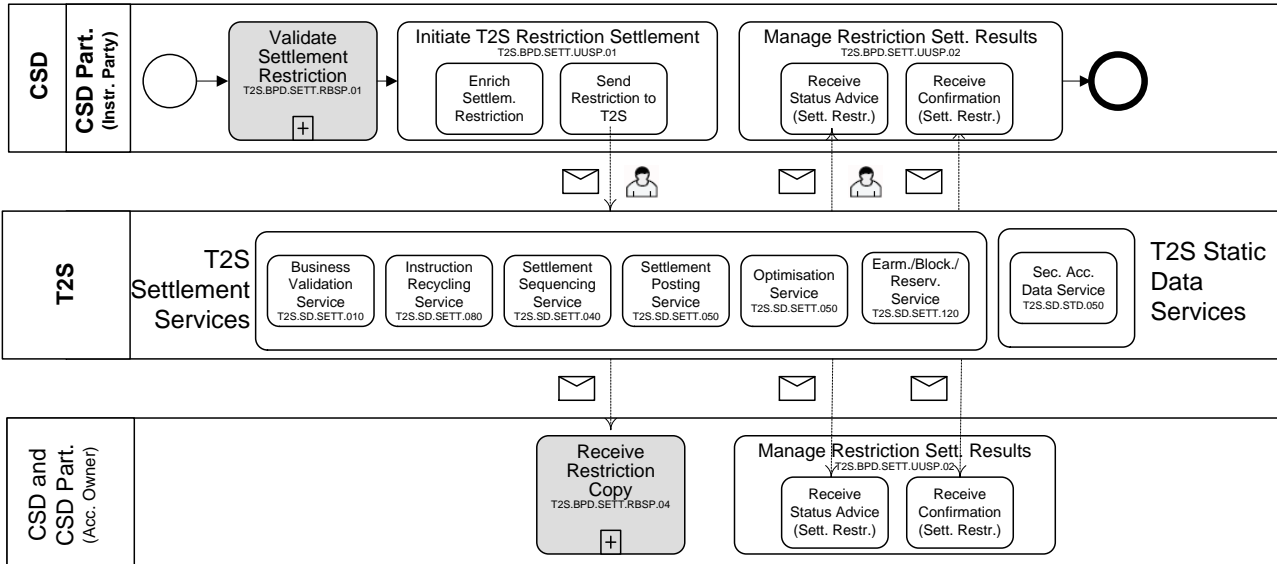

4 **3.6.3 BUSINESS PROCESS DESCRIPTION**

5 **3.6.3.1 INITIATE T2S RESTRICTION SETTLEMENT**

Reference ID	T2S.BPD.SETT.UUSP.01
---------------------	----------------------

6 T2S Actors: CSD (Scenario A)/CSD Participant (Scenario B)

7 The CSD [CSD Participant] enriches the settlement Restriction on a securities position with details required
 8 for settlement processing in T2S and sends the settlement restriction on securities position to T2S.

9 References:

10 UDFS: Use Case “Send Settlement Restriction on Securities position” (Chapter 2.4)

11 GUI BFD: T2S.GUI.SESE.INX.0070

12 **3.6.3.1.1 Enrich Settlement Restriction**

Reference ID	T2S.BPD.SETT.UUSP.01.01
---------------------	-------------------------

13 The CSD [CSD Participant] enriches the settlement restriction on securities position with T2S specific
 14 information like securities account reference, quantity of securities to be unblocked or unreserved, ISIN. The
 15 balance “From” and balance “To” need to be filled with the restriction type Id already defined by the T2S
 16 operator or the CSD.

- 1 • In the balance “From”, the allowed Restriction type Ids are the ones pertaining to “Blocking³⁰” or
2 “Reservation” processing types.
 - 3 • In the balance “To”, the allowed Restriction type Ids are the ones pertaining to the “Deliverable”,
4 “Earmarking” and “earmarking for auto-collateralisation” processing types.
- 5 The restriction reference identifying the securities position to be decreased need to be specified.

6 **Figure 3-8: Enrich Settlement Restriction [T2S.BPD.SETT.UUSP.01.01]**

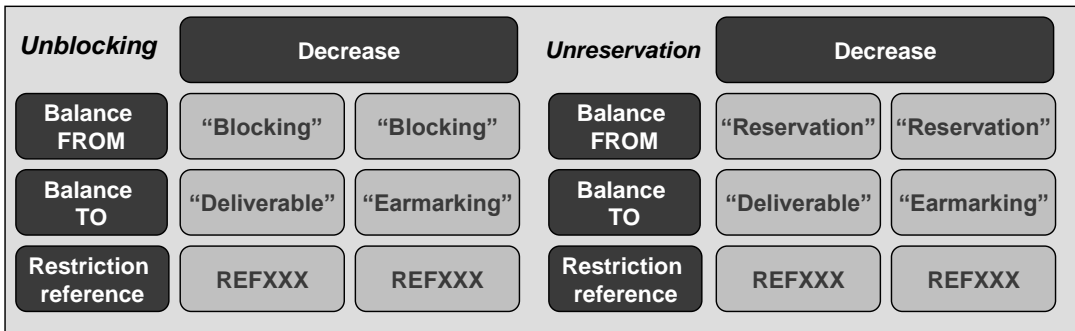

7

8 **3.6.3.1.2 Send Restriction to T2S**

Reference ID	T2S.BPD.SETT.UUSP.02.02
--------------	-------------------------

9 The CSD [CSD Participant] converts the enriched settlement restriction message on securities position
10 enriched with T2S specific information into the required message format and transmits it to T2S.

11 The instruction of T2S is also possible via the T2S GUI.

12 The CSD [CSD Participant] sends the following message to T2S:

13 **Table 3-20: Messages to T2S [T2S.BPD.SETT.UUSP.02.02]**

Message Name	ISO Code	To/From T2S	UDFS Chapter
IntraPositionMovementInstruction	semt.013.001.02	To T2S	3.3.7.2

14 **3.6.3.2 T2S PROCESSING**

15 The **Business Validation Service (T2S.SD.SETT.010)** validates the received Intra-Position Movement
16 Instruction. After successful validation the **Earmarking, Blocking and Reservation Service**
17 **(T2S.SD.SETT.120)** executes the unblocking or the unreservation of the securities position and informs the
18 relevant parties (IntraPositionMovementStatusAdvice and IntraPositionMovementConfirmation).

³⁰ “CoSD Blocking” processing type not allowed

1 The remaining settlement of the settlement restrictions follows the settlement lifecycle of a settlement
 2 instruction and involves the **Settlement Sequencing Service (T2S.SD.SETT.040)**, **Settlement Posting**
 3 **Service (T2S.SD.SETT.050)**, **Optimisation Service (T2S.SD.SETT.060)** and **Instruction recycling**
 4 **Service (T2S.SD.SETT.080)**. For details on these T2S services, refer to process “Intra-CSD Settlement
 5 [T2S.BPD.SETT.ICSD]”.

6 **3.6.3.3 MANAGE RESTRICTION SETTLEMENT RESULTS**

Reference ID	T2S.BPD.SETT.UUSP.02
---------------------	----------------------

7 T2S Actors: CSD and CSD Participant (both scenarios)

8 The CSD and CSD Participant receive the settlement related messages from T2S and initiate related internal
 9 processes.

10 In both scenarios, the CSD and the CSD Participant receive the messages. When a CSD instructs T2S
 11 (Scenario A), the CSD Participant (if directly connected) can also receive these messages. Similarly, when
 12 the CSD Participant instructs T2S (Scenario B), the CSD can also receive the messages.

13 References:

14 UDFS: Use Case “Send Settlement Restriction on Securities position” (Chapter 2.4)

15 GUI BFD: T2S.GUI.SESE.INX.0070, T2S.GUI.SESE.INX.0010, T2S.GUI.SESE.INX.0020,
 16 T2S.GUI.SESE.INX.0030

17 **3.6.3.3.1 Receive Status Advice (Settlement Restriction)**

Reference ID	T2S.BPD.SETT.UUSP.02.01
---------------------	-------------------------

18 The CSD and CSD Participant can receive status advices notifying of

- 19 • rejection of the settlement restriction on securities position,
- 20 • acceptance of the settlement restriction on securities position,
- 21 • eligibility failure of the settlement restriction on securities position,
- 22 • provision check failure of the settlement restriction on securities position.

23 If T2S has been instructed via the T2S GUI the status is shown on the screen.

24 Following the message reception, other internal activities might be conducted such as:

- 25 • aligning the status of the settlement restriction on securities position in the CSD or CSD Participant’s
 26 systems with the status in T2S,
- 27 • triggering notification to CSD Participants in case the CSD instructed on their behalf,

- 1 • performing analysis after a failed instruction or a failed provision check.
- 2 The CSD and CSD Participant receive the following messages from T2S:

3 **Table 3-21: Messages from T2S [T2S.BPD.SETT.UUSP.02.01]**

Name	ISO Code	From/To T2S	Event	UDFS Chapter
IntraPositionMovementStatusAdvice	semt.014.001.03	From T2S	Positive or failed business validation, Eligibility failure, Intra-day restriction, Provision check failure	3.3.7.3

4 **3.6.3.3.2 Receive Confirmation (Settlement Restriction)**

Reference ID	T2S.BPD.SETT.UUSP.02.02
---------------------	-------------------------

5 The CSD and CSD Participant receive

- 6 • in the case of unblocking from T2S one settlement confirmation indicating the settlement status (i.e. full settlement),
- 7
- 8 • in the case of unreservation from T2S one settlement confirmations indicating the settlement status (i.e. full or partial³¹ settlement).
- 9

10 Following the message reception, other internal activities might be conducted such as:

- 11 • aligning the status of the settlement restriction on securities position in the CSD or CSD Participant's systems with the status in T2S,
- 12
- 13 • initiating actions in case of partial settlement of the restriction,
- 14 • triggering notification to CSD Participants in case the CSD instructed on their behalf.
- 15

³¹ Settled for the available reserved quantity even if lower than the instructed quantity. No pre-emption.

1 The CSD and CSD Participant receive the following messages form T2S:

2 **Table 3-22: Messages from T2S [T2S.BPD.SETT.UUSP.02.02]**

Name	ISO Code	From/To T2S	Event	UDFS Chapter
IntraPositionMove mentConfirmation	sent.015.001.03	From T2S	The restriction for unblocking or unreservation has fully settled, the restriction for unreservation has partially settled	3.3.7.4

3

1 3.7 EARMARKING OF SECURITIES POSITION [T2S.BPD.SETT.EARM]

2 3.7.1 OVERVIEW

3 This process describes the act of earmarking a securities position in T2S. A CSD or CSD Participant can
4 send a settlement restriction instruction (on securities) to earmark a securities position for a given purpose.

5 Earmarking is the process of specifying that a certain quantity of a security in one securities account is only
6 eligible for specific type of transactions or processes. For example, a bank can earmark a securities position
7 in a securities account for use as eligible collateral.

8 As a result of the settlement instruction a certain quantity of securities position is transferred from one
9 position type such as deliverable/ earmarked into another within the same securities account. It is to be noted
10 that the earmarking does not trigger any restriction reference.

11 For details on the unearmarking of a securities position, refer to process “Unearmarking of Securities
12 Position [T2S.BPD.SETT.UEAR]”.

13 For details on the restriction of static data objects (e.g. securities accounts), refer to section “Static Data
14 Restriction Processes”.

15 **Trigger:**

16 The CSD or CSD Participant receives details for earmarking the securities position.

17 **Preconditions:**

- 18 • Securities account containing the securities position to be earmarked is known.
- 19 • The restriction type Id signifying the “earmarked” position types that are referenced are known (set-up
20 by the CSD or the T2S operator) to the market participants.

21

1 **T2S Instructing Party:**

2 There are two scenarios for the instruction of T2S:

- 3 • Scenario A: CSD instructs T2S.
 4 • Scenario B: CSD Participant instructs T2S.

5 **3.7.2 BUSINESS PROCESS DIAGRAM**

6 **Figure 3-9: Business Process Diagram [T2S.BPD.SETT.EARM]**

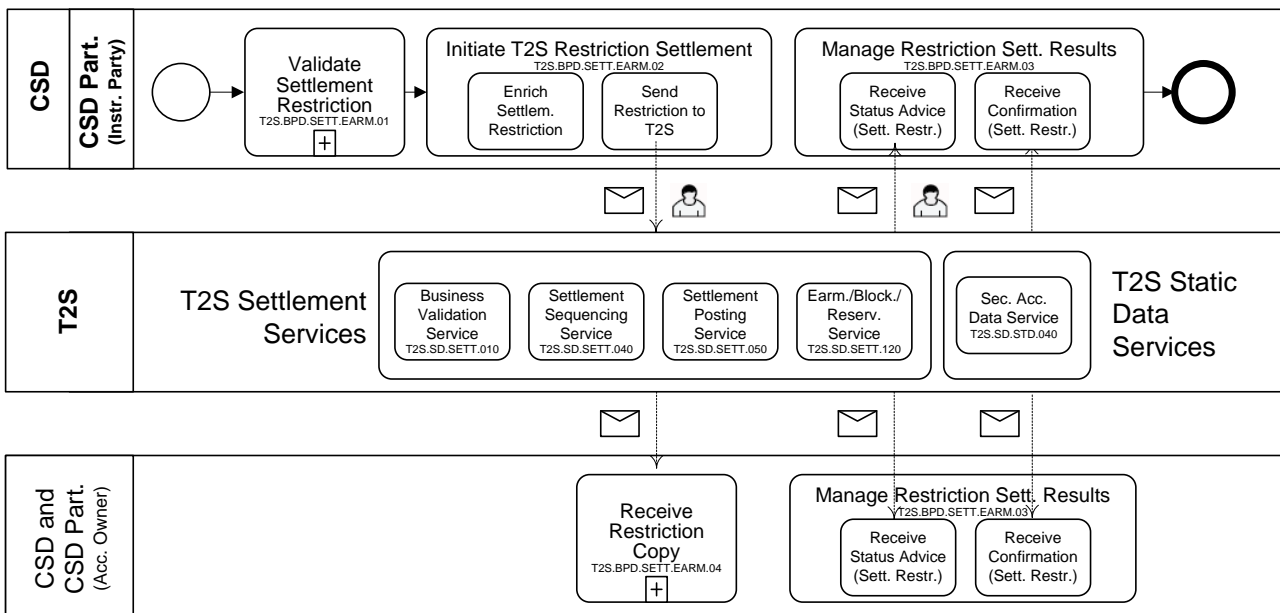

8 **3.7.3 BUSINESS PROCESS DESCRIPTION**

9 **3.7.3.1 VALIDATE SETTLEMENT RESTRICTION**

Reference ID	T2S.BPD.SETT.EARM.01
---------------------	----------------------

10 T2S Actors: CSD (Scenario A)/CSD Participant (Scenario B)

11 The CSD [CSD Participant] checks all the details of the settlement restriction on securities position against
 12 the reference data (maintained by the CSD or CSD Participant if directly connected).

13 **3.7.3.2 INITIATE T2S RESTRICTION SETTLEMENT**

Reference ID	T2S.BPD.SETT.EARM.02
---------------------	----------------------

14 T2S Actors: CSD (Scenario A)/CSD Participant (Scenario B)

15 The CSD [CSD Participant] enriches the settlement restriction on a securities position with the details
 16 required for settlement processing in T2S and sends the settlement restriction on securities position to T2S.

1 References:

2 UDFS: Use Case “Send Settlement Restriction on Securities position”(Chapter 2.4)

3 GUI BFD: T2S.GUI.SESE.INX.0070

4 **3.7.3.2.1 Enrich Settlement Restriction**

Reference ID	T2S.BPD.SETT.EARM.02.01
---------------------	-------------------------

5 The CSD [CSD Participant] enriches the settlement restriction on securities position with T2S specific
 6 information like T2S securities account reference, quantity of securities to be earmarked, ISIN. The Balance
 7 “From” and Balance “To” need to be filled with the restriction type Id already defined by the T2S operator or
 8 the CSD.

- 9 • In the Balance “From”, the allowed Restriction type Ids are the ones pertaining to “Deliverable”,
 10 “Blocking”, “Reservation”, and “Earmarking” or “Earmarking for auto-collateralisation” processing
 11 types. (Any in T2S except the “collateralised” and “CoSD blocking” processing types).
- 12 • In the Balance “To”, the allowed Restriction type Ids are the ones pertaining to the “Earmarking” and
 13 “earmarking for auto-collateralisation” processing types.

14 **3.7.3.2.2 Send Restriction to T2S**

Reference ID	T2S.BPD.SETT.EARM.02.02
---------------------	-------------------------

15 The CSD [CSD Participant] converts the settlement restriction on securities position enriched with T2S
 16 specific information and transmits it to T2S.

17 The instruction of T2S is also possible via the T2S GUI.

18 The CSD [CSD Participant] sends the following message to T2S:

19 **Table 3-23: Messages to T2S [T2S.BPD.SETT.EARM.02.02]**

Name	ISO Code	From/To T2S	Event	UDFS Chapter
IntraPositionMove mentInstruction	semt.013.001.03	To T2S	Need to earmark securities position	3.3.7.2

20 **3.7.3.3 T2S PROCESSING**

21 The **Business Validation Service (T2S.SD.SETT.010)** validates the received Intra-Position Movement
 22 Instruction. After successful validation the **Earmarking, Blocking and Reservation Service**
 23 **(T2S.SD.SETT.120)** executes the earmarking of the securities position and informs the relevant parties
 24 (IntraPositionMovementStatusAdvice and IntraPositionMovementConfirmation).

1 The remaining settlement of the settlement restrictions follows the settlement lifecycle of a settlement
 2 instruction and involves the **Settlement Sequencing Service (T2S.SD.SETT.040)**, **Settlement Posting**
 3 **Service (T2S.SD.SETT.050)**, **Optimisation Service (T2S.SD.SETT.060)** and **Instruction recycling**
 4 **Service (T2S.SD.SETT.080)**. For details on these T2S services, refer to process “Intra-CSD Settlement
 5 [T2S.BPD.SETT.ICSD]”.

6 **3.7.3.4 MANAGE RESTRICTION SETTLEMENT RESULTS**

Reference ID	T2S.BPD.SETT.EARM.03
---------------------	----------------------

7 T2S Actors: CSD (Scenario A)/CSD Participant (Scenario B)

8 The CSD [CSD Participant] receives the settlement related messages from T2S and initiates related internal
 9 processes.

10 References:

11 UDFS: Use Case “Send Settlement Restriction on Securities position”(Chapter 2.4)

12 GUI BFD: T2S.GUI.SESE.INX.0070, T2S.GUI.SESE.INX.0010, T2S.GUI.SESE.INX.0020,
 13 T2S.GUI.SESE.INX.0030

14 **3.7.3.4.1 Receive Restriction Status Advice**

Reference ID	T2S.BPD.SETT.EARM.03.01
---------------------	-------------------------

15 For this activity the CSD [CSD Participant] can receive status advices notifying of

- 16 • rejection of the settlement restriction on securities position,
- 17 • acceptance of the settlement restriction on securities position,
- 18 • eligibility failure of the settlement restriction on securities position,
- 19 • intraday restriction on the settlement restriction on securities position,
- 20 • provision check failure of the settlement restriction on securities position.

21 If T2S has been instructed via the T2S GUI the status is shown on the screen.

22 Following the message reception, other internal activities might be conducted such as:

- 23 • aligning the status of the settlement restriction on securities position in the CSD or CSD Participant’s
 24 systems with the status in T2S,
- 25 • triggering notification to CSD Participants in case the CSD instructed on their behalf,
- 26 • performing analysis after a failed settlement restriction on securities position or a failed provision check.

1 The CSD [CSD Participant] receives the following messages form T2S:

2 **Table 3-24: Messages from T2S [T2S.BPD.SETT.EARM.03.01]**

Name	ISO Code	From/To T2S	Event	UDFS Chapter
IntraPositionMovementStatusAdvice	semt.014.001.03	From T2S	Positive or failed business validation, Eligibility failure, Intra-day restriction, Provision check failure	3.3.7.3

3 **3.7.3.4.2 Receive Restriction Confirmation**

Reference ID	T2S.BPD.SETT.EARM.03.02
--------------	-------------------------

4 The CSD [CSD Participant] receives a settlement confirmation indicating the settlement status (i.e. full
5 settlement or partial execution of the restriction);

6 Following the message reception, other internal activities might be conducted such as:

- 7 • aligning the status of the settlement restriction on securities position in the CSD or CSD Participant’s
- 8 systems with the status in T2S,
- 9 • initiating necessary actions in case of partial settlement of the restriction,
- 10 • triggering notification to CSD Participants in case the CSD instructed on their behalf.

11 The CSD [CSD Participant] receives the following messages from T2S:

12 **Table 3-25: Messages from T2S [T2S.BPD.SETT.EARM.03.02]**

Name	ISO Code	From/To T2S	Event	UDFS Chapter
IntraPositionMovementConfirmation	semt.015.001.03	From T2S	The restriction for earmarking has fully settled, the restriction for earmarking has partially settled	3.3.7.4

13 **3.7.3.5 RECEIVE RESTRICTION COPY**

Reference ID	T2S.BPD.SETT.EARM.04
--------------	----------------------

14 T2S Actors: CSD Participant (Scenario A)/CSD (Scenario B)

15 The CSD Participant [CSD] receives the copy of the inbound settlement restriction on securities position.

- 1 The CSD Participant [CSD] initiates the relevant processes on his side.
- 2 The CSD Participant [CSD] receives the following message from T2S:

3 **Table 3-26: Messages from T2S [T2S.BPD.SETT.EARM.04]**

Name	ISO Code	From/To T2S	Event	UDFS Chapter
IntraPositionMovementInstruction	semt.013.001.03	From T2S	After validation of inbound earmarking instruction	3.3.7.2

4

1 **3.8 UNEARMARKING OF SECURITIES POSITION [T2S.BPD.SETT.UEAR]**

2 **3.8.1 OVERVIEW**

3 This process describes the act of unearmarking a securities position in T2S. Unearmarking of securities
4 position refers to the process of transferring a certain quantity of securities position within a securities
5 account from an earmarked position in to another securities position such as deliverable. The instructing
6 party may free some quantity of securities position in order to make them available for settlement.³²

7 For details on the restriction of static data objects (e.g. securities accounts), refer to section “Static Data
8 Restriction Processes”.

9 This process is a variation of the process “Earmarking of Securities Position [T2S.BPD.SETT.EARM]”. The
10 steps highlighted in the diagram below require particular attention.

11 **Trigger:**

12 Instructing party receives details for unearmarking the securities position

13 **Preconditions:**

- 14 • Securities account containing the earmarked securities position (to be un-earmarked) is known.
15 • The restriction type Id that are referenced are known (set-up by the CSD or the T2S Operator) by the
16 market participants.

17 **T2S Instructing Party:**

18 There are two scenarios for the instruction of T2S:

- 19 • Scenario A: CSD instructs T2S.
20 • Scenario B: CSD Participant instructs T2S.

³² In case of an earmarked securities account, the instructing party can only transfer the earmarked securities to set-up or increase a blocked or reserved position.

1 3.8.2 BUSINESS PROCESS DIAGRAM

2 **Figure 3-10: Business Process Diagram [T2S.BPD.SETT.UEAR]**

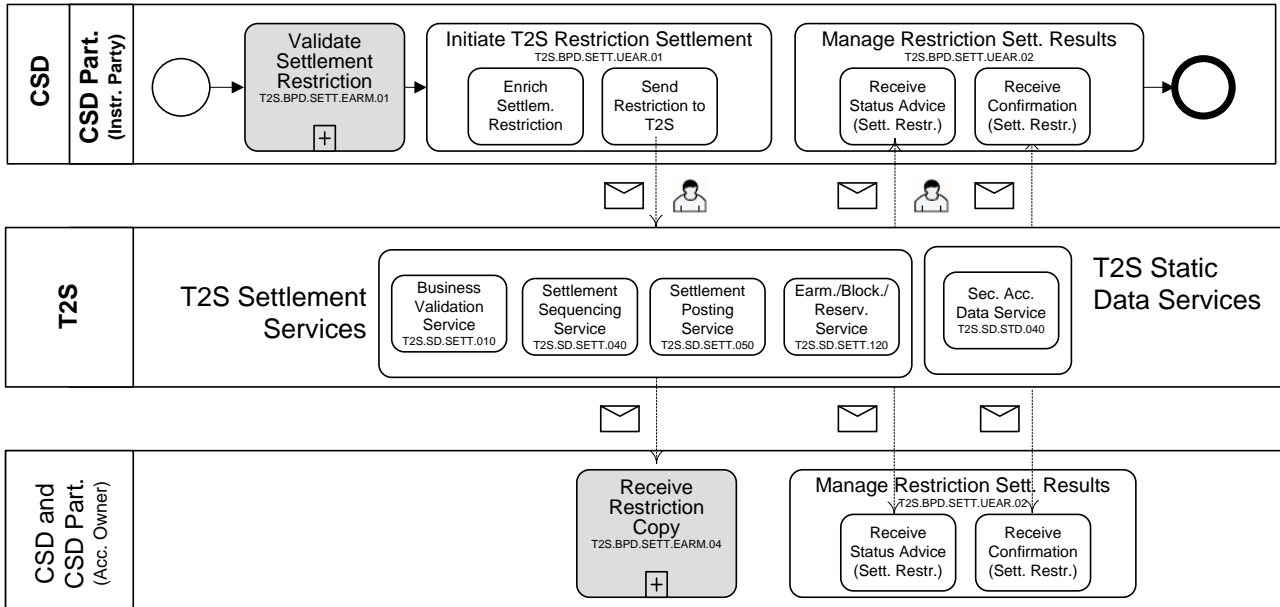

4 3.8.3 BUSINESS PROCESS DESCRIPTION

5 3.8.3.1 INITIATE T2S RESTRICTION SETTLEMENT

Reference ID	T2S.BPD.SETT.UEAR.01
---------------------	----------------------

6 T2S Actors: CSD (Scenario A)/CSD Participant (Scenario B)

7 The CSD [CSD Participant] enriches the settlement restriction on securities position with details required for
 8 settlement processing in T2S and sends the settlement restriction on securities position to T2S.

9 References:

10 UDFS: Use Case “Send Settlement Restriction on Securities position” (Chapter 2.4)

11 GUI BFD: T2S.GUI.SESE.INX.0070

12 3.8.3.1.1 Enrich Settlement Restriction

Reference ID	T2S.BPD.SETT.UEAR.01.01
---------------------	-------------------------

13 The CSD [CSD Participant] enriches the settlement restriction on securities position with T2S specific
 14 information like T2S securities account reference, quantity of securities to be unearmarked, ISIN. The
 15 Balance “From” and Balance “To” need to be filled with the restriction type Id already defined by the T2S
 16 operator or the CSD.

- 1 • In the Balance “From”, the allowed Restriction type Ids are the ones pertaining to “Earmarking” or
 - 2 “Earmarking for auto-collateralisation” processing types.³³
 - 3 • In the Balance “To”, the allowed Restriction type Ids are the ones pertaining to the “Deliverable”,
 - 4 “Earmarking”, “Earmarking for auto-collateralisation”, “blocking”, “reservation” processing types.
- 5 A Restriction reference does not exist for an earmarked securities position and hence cannot be used in the
- 6 case of unearmarking of a securities position.

7 **3.8.3.1.2 Send Restriction to T2S**

Reference ID	T2S.BPD.SETT.UEAR.01.02
---------------------	-------------------------

8 The CSD [CSD Participant] converts the settlement restriction on securities position enriched with T2S

9 specific information and transmits it to T2S.

10 The instruction of T2S is also possible via the T2S GUI.

11 The CSD [CSD Participant] sends the following message to T2S:

Name	ISO Code	From/To T2S	Event	UDFS Chapter
IntraPositionMovementInstruction	semt.013.001.03	To T2S	Need to unearmark securities position	3.3.7.2

12 **3.8.3.2 T2S PROCESSING**

13 The **Business Validation Service (T2S.SD.SETT.010)** validates the received Intra-Position Movement

14 Instruction. After successful validation the **Earmarking, blocking and reservation service**

15 **(T2S.SD.SETT.120)** executes the unearmarking of the securities position and informs the relevant parties

16 (IntraPositionMovementStatusAdvice and IntraPositionMovementConfirmation).

17 The remaining settlement of the settlement restrictions follows the settlement lifecycle of a settlement

18 instruction and involves the **Settlement Sequencing Service (T2S.SD.SETT.040)**, **Settlement Posting**

19 **Service (T2S.SD.SETT.050)**, **Optimisation Service (T2S.SD.SETT.060)** and **Instruction recycling**

20 **Service (T2S.SD.SETT.080)**. For details on these T2S services, refer to process “Intra-CSD Settlement

21 [T2S.BPD.SETT.ICSD]”.

22 **3.8.3.3 MANAGE RESTRICTION SETTLEMENT RESULTS**

Reference ID	T2S.BPD.SETT.UEAR.02
---------------------	----------------------

³³ It is possible to block or reserve securities in an earmarked securities account. The balance From of the blocking or reservation instruction should contain the restriction type Id that was used to earmark the securities account.

- 1 T2S Actors: CSD (Scenario A)/CSD Participant (Scenario B)
- 2 The CSD [CSD Participant] receives the settlement related messages from T2S and initiates related internal
- 3 processes.
- 4 References:
- 5 UDFS: Use Case “Send Settlement Restriction on Securities position” (Chapter 2.4)
- 6 GUI BFD: T2S.GUI.SESE.INX.0070, T2S.GUI.SESE.INX.0010, T2S.GUI.SESE.INX.0020,
- 7 T2S.GUI.SESE.INX.0030

8 **3.8.3.3.1 Receive Restriction status advice**

Reference ID	T2S.BPD.SETT.UEAR.02.01
---------------------	-------------------------

9 For this activity the CSD [CSD Participant] can receive status advices notifying of:

- 10 • rejection of the settlement restriction on securities position,
- 11 • acceptance of the settlement restriction on securities position,
- 12 • eligibility failure of the settlement restriction on securities position,
- 13 • intraday restriction applying on the settlement restriction on securities position,
- 14 • provision check failure of the settlement restriction on securities position.

15 If T2S has been instructed via the T2S GUI the status is shown on the screen.

16 Following the message reception, other internal activities might be conducted such as:

- 17 • aligning the status of the settlement restriction on securities position in the CSD or CSD Participant’s
- 18 systems with the status in T2S,
- 19 • triggering notification to CSD Participants in case the CSD instructed on their behalf,
- 20 • performing analysis after a failed instruction or a failed provision check.

21

1 The CSD [CSD Participant] receives the following messages from T2S:

2 **Table 3-27: Messages from T2S [T2S.BPD.SETT.UEAR.02.01]**

Name	ISO Code	From/To T2S	Event	UDFS Chapter
IntraPositionMovementStatusAdvice	semt.014.001.03	From T2S	Positive or failed business validation, Eligibility failure, Intra-day restriction, Provision check failure	3.3.7.3

3 **3.8.3.3.2 Receive Restriction confirmation**

Reference ID	T2S.BPD.SETT.UEAR.02.02
---------------------	-------------------------

4 For this activity the CSD [CSD Participant] receives one settlement confirmation indicating the settlement
 5 status (i.e. full settlement or partial execution) in the case of unearmarking from T2S.

6 Following the message reception, other internal activities might be conducted such as:

- 7 • aligning the status of the settlement restriction on securities position in the CSD or CSD Participant’s
- 8 systems with the status in T2S,
- 9 • initiating actions in case of partial execution of the restriction,
- 10 • triggering notification to CSD Participants in case the CSD instructed on their behalf.

11 The CSD [CSD Participant] receives the following messages from T2S:

12 **Table 3-28: MESSAGES from T2S [T2S.BPD.SETT.UEAR.02.02]**

Name	ISO Code	From/To T2S	Event	UDFS Chapter
IntraPositionMovementConfirmation	semt.015.001.03	From T2S	The restriction for unearmarking has fully settled, the restriction for unearmarking has partially settled	3.3.7.4

13

1 3.9 RESERVATION OR BLOCKING OF CASH BALANCE 2 [T2S.BPD.SETT.RBCB]

3 3.9.1 OVERVIEW

4 This process describes the act of reserving or blocking a certain amount of cash within a Dedicated Cash
5 Account for a specific purpose to prevent that this amount is used. The Payment Bank could block cash in
6 order to ensure later settlement of a settlement instruction for instance. It results in a transfer from one cash
7 balance to another within the same dedicated cash account.

- 8 • Blocking is a process of preventing the transfer of a specified amount of funds in a specific currency in
9 one cash account to any other cash account by associating it to a specific transaction or to a specific
10 purpose. Blocking in T2S may never result in a negative cash balance, i.e. it is not possible to block an
11 amount of funds greater than the cash balance on a cash account (no partial execution of a blocking).
- 12 • Reservation is a process of preventing the transfer of a specified amount of funds in a specific currency
13 in one cash account to any other cash account except for the purpose for which the funds were reserved.
14 The settlement of the underlying settlement instruction results in the actual transfer of the reserved funds
15 to another cash account and in the subsequent removal of the reservation. It is possible to reserve an
16 amount greater than the balance on the cash account.

17 At end-of-day, T2S releases the cash restrictions, therefore the participants need re-instructed the next day
18 should they need to block or reserve cash.

19 For details on the unreservation or unblocking of a cash balance, refer to process “Unreservation or
20 Unblocking of Cash Balance [T2S.BPD.SETT.UUCB]”.

21 For details on the restriction of static data objects (e.g. securities accounts), refer to section “Static Data
22 Restriction Processes”.

23 **Trigger:**

24 The Central Bank or the Payment Bank receives details for reserving or blocking the cash balance

25 **Preconditions:**

- 26 • T2S dedicated cash account containing the cash balance to be reserved or blocked is known.
- 27 • The restriction type to be used for the blocking/reservation is known.

- 1 • Blocking or reservation reference is known, when an existing blocked or reserved balance should be
 2 increased³⁴.

3 **T2S Instructing Party:**

4 There are two scenarios for the instruction of T2S:

- 5 • Scenario A: Central Bank instructs T2S.
 6 • Scenario B: Payment Bank instructs T2S.

7 **3.9.2 BUSINESS PROCESS DIAGRAM**

8 **Figure 3-11: Business Process Diagram [T2S.BPD.SETT.RBCB]**

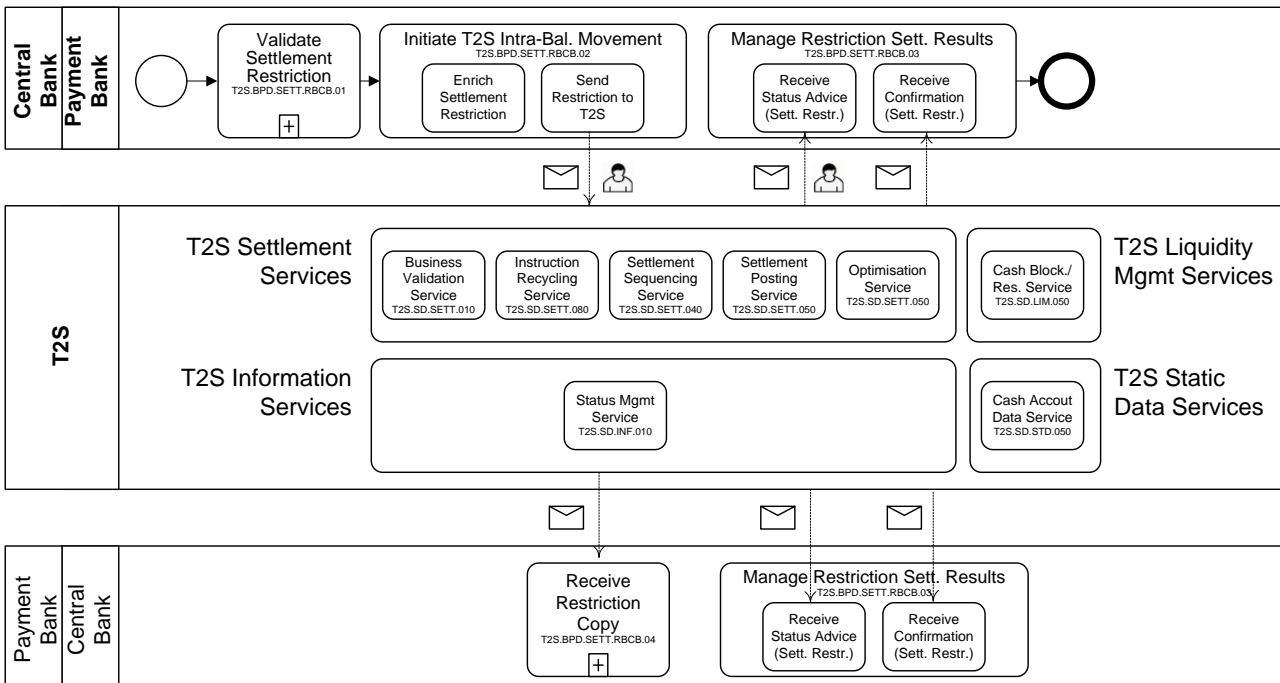

9
 10 **3.9.3 BUSINESS PROCESS DESCRIPTION**

11 This Business Process Description is applicable to Scenario A and B unless otherwise noted. For the purpose
 12 of readability, the actor names in the text refer to Scenario A with the Scenario B actor indicated in square
 13 brackets.

14 **3.9.3.1 VALIDATE SETTLEMENT RESTRICTION**

Reference ID	T2S.BPD.SETT.RBCB.01
--------------	----------------------

³⁴ The restriction reference is also used for decrease, this part is covered in the process “Unreservation or unblocking of Cash Balance [T2S.BPD.SETT.UUCB]”.

1 T2S Actors: Central Bank (Scenario A)/Payment Bank (Scenario B)
 2 The Central Bank [Payment Bank] checks all the details in the settlement restriction on cash balance against
 3 the reference data (maintained by the Central Bank or the Payment Bank if directly connected).

4 **3.9.3.2 INITIATE T2S INTRA-BALANCE MOVEMENT**

Reference ID	T2S.BPD.SETT.RBCB.02
--------------	----------------------

5 T2S Actors: Central Bank (Scenario A)/Payment Bank (Scenario B)
 6 The Central Bank [Payment Bank] enriches the settlement restriction on cash balance with details required
 7 for settlement processing in T2S and sends the settlement restriction on cash balance to T2S.

8 References:

9 UDFS: Use Case “Send Settlement Restriction on Cash Balance” (Chapter 2.5)

10 GUI BFD: T2S.GUI.SESE.INX.0070

11 **3.9.3.2.1 Enrich Settlement Restriction**

Reference ID	T2S.BPD.SETT.RBCB.02.01
--------------	-------------------------

12 The Central Bank [Payment Bank] enriches the settlement restriction on cash balance with T2S specific
 13 information such as reference of the dedicated cash account, amount of cash to be blocked or reserved. The
 14 balance “From” and balance “To” need to be filled with the restriction type Id already defined by the T2S
 15 Operator or the Central Bank.

- 16 • In the balance “From”, the allowed Restriction type Id is the one pertaining to the “Deliverable”
 17 processing type only.
- 18 • In the balance “To”, the allowed Restriction type Ids are the ones pertaining to the “Blocking” or
 19 “Reservation” processing types.

20 In case the participant specifies a restriction reference³⁵, the blocked or reserved cash balance referred to in
 21 the balance “To” will be increased. If no restriction reference is specified, a new restricted balance will be
 22 created.

³⁵ This restriction reference was provided in the confirmation of the set-up of the blocked or reserved balance.

1 **Figure 3-12: Enrich Settlement Restriction [T2S.BPD.SETT.RBCB.02.01]**

Blocking	Set-up	Increase	Reservation	Set-up	Increase
Balance FROM	“Deliverable”	“Deliverable”	Balance FROM	“Deliverable”	“Deliverable”
Balance TO	“Blocking”	“Blocking”	Balance TO	“Reservation”	“Reservation”
Restriction reference	<i>Empty</i>	REFXXX	Restriction reference	<i>Empty</i>	REFXXX

2

3 **3.9.3.2.2 Send Restriction to T2S**

Reference ID	T2S.BPD.SETT.RBCB.02.02
--------------	-------------------------

4 The Central Bank [Payment Bank] converts the settlement restriction on cash balance enriched with T2S
 5 specific information into the required message format and transmits it to T2S.

6 The instruction of T2S is also possible via the T2S GUI.

7 The Central Bank [Payment Bank] sends the following message to T2S:

8 **Table 3-29: Messages to T2S [T2S.BPD.SETT.RBCB.02.02]**

Message Name	ISO Code	To/From T2S	UDFS Chapter
IntraBalanceMovementInstruction	camt.066.001.01	To T2S	3.3.3.20

9 **3.9.3.3 T2S PROCESSING**

10 The **Business Validation Service (T2S.SD.SETT.010)** validates the received Intra-Balance Movement
 11 Instruction. After successful validation the **Cash Blocking and Reservation Service (T2S.SD.LIM.050)**
 12 executes the reservation or blocking of the cash balance and informs the relevant parties
 13 (IntraBalanceMovementStatusAdvice and IntraBalanceMovementConfirmation).

14 The remaining settlement of the settlement restrictions follows the settlement lifecycle of a settlement
 15 instruction and involves the **Settlement Sequencing Service (T2S.SD.SETT.040)**, **Settlement Posting
 16 Service (T2S.SD.SETT.050)** and **Optimisation Service (T2S.SD.SETT.060)**. For details on these T2S
 17 services, refer to process “Intra-CSD Settlement [T2S.BPD.SETT.ICSD]”.

18 **3.9.3.4 MANAGE RESTRICTION SETTLEMENT RESULTS**

Reference ID	T2S.BPD.SETT.RBCB.03
--------------	----------------------

1 T2S Actors: Central Bank (Scenario A)/Payment Bank (Scenario B)
 2 The Central Bank and Payment Bank receive the settlement related messages from T2S and initiate related
 3 internal processes.

4 In both scenarios, the Central Bank and Payment Bank receive the messages. When a Central Bank instructs
 5 T2S (Scenario A), the Payment Bank can also receive these messages. Similarly, when a Payment Bank
 6 instructs T2S (Scenario B), the Central Bank can also receive the messages.

7 References:

8 UDFS: Use Case “Send Settlement Restriction on Cash Balance” (Chapter 2.5)

9 GUI BFD: T2S.GUI.SESE.INX.0070, T2S.GUI.SESE.INX.0010, T2S.GUI.SESE.INX.0020,
 10 T2S.GUI.SESE.INX.0030

11 **3.9.3.4.1 Receive Status Advice (Settlement Restriction)**

Reference ID	T2S.BPD.SETT.RBCB.03.01
--------------	-------------------------

12 The Central Bank and Payment Bank can receive status advices notifying of:

- 13 • rejection of the settlement restriction on cash balance,
- 14 • acceptance of the settlement restriction on cash balance,
- 15 • eligibility failure of the settlement restriction on cash balance,
- 16 • provision check failure of the settlement restriction on cash balance,
- 17 • the remaining part of a reservation to be settled in case of partial settlement,
- 18 • pending status in case of blocking.

19 If T2S has been instructed via the T2S GUI the status is shown on the screen.

20 Following the message reception, other internal activities might be conducted such as:

- 21 • aligning the status of the settlement restriction on cash balance in the Central Bank’s or Payment Bank’s
 22 systems with the status in T2S,
- 23 • triggering notification to Payment Banks in case the Central Bank instructed on their behalf,
- 24 • analysing the failed or rejected settlement restriction.

25

1 The Central Bank and Payment Bank receive the following messages from T2S:

2 **Table 3-30: Messages from T2S [T2S.BPD.SETT.RBCB.03.01]**

Message Name	ISO Code	To/From T2S	Event	UDFS Chapter
IntraBalanceMovementStatusAdvice/“Rejected”	camt.067.001.01	From T2S	Positive or failed business validation, Eligibility failure, Intra-day restriction, Failed provision check	3.3.3.21
IntraBalanceMovementStatusAdvice/“Accepted”	camt.067.001.01	From T2S	Positive business validation, Partial settlement of a reservation (pending part), Pending status for blocking	3.3.3.21

3 **3.9.3.4.2 Receive Confirmation (Settlement Restriction)**

Reference ID	T2S.BPD.SETT.RBCB.03.02
--------------	-------------------------

4 The Central Bank and Payment Bank receive:

- 5 • in case of blocking from T2S: one settlement confirmation indicating the settlement status (i.e. full
6 settlement),
- 7 • in case of reservation from T2S: one or more (due to pre-emption) settlement confirmations indicating
8 the settlement status (i.e. full, partial and last partial settlement).

9 Following the message reception, other internal activities might be conducted such as:

- 10 • aligning the status of the settlement restriction on cash balance in the Central Bank or Payment Bank’s
11 systems with the status in T2S,
- 12 • triggering notification to Payment Bank in case the Central Bank instructed on their behalf,
- 13 • storing the restriction reference transmitted by T2S for later use, increase, decrease of the
14 blocked/reserved cash balance.

15

1 The Central Bank and Payment Bank receive the following messages from T2S:

2 **Table 3-31: Messages from T2S [T2S.BPD.SETT.RBCB.03.02]**

Message Name	ISO Code	To/From T2S	Event	UDFS Chapter
IntraBalanceMovementConfirmation	camt.068.001.01	From T2S	The cash blocking or reservation is fully settled, the last partial settlement of a reservation is confirmed, Partial settlement of the reservation (not the last one)	3.3.3.22

3 **3.9.3.5 RECEIVE RESTRICTION COPY**

Reference ID	T2S.BPD.SETT.RBCB.04
--------------	----------------------

4 T2S Actors: Payment Bank (Scenario A)/Central Bank (Scenario B)

5 The Payment Bank [Central Bank] receives the copy of the inbound settlement restriction on cash balance
6 after it has been validated by T2S.

7 The Payment Bank [Central Bank] may conduct relevant internal processes such as:

- 8 • creating the restriction instruction in its system,
- 9 • monitoring the lifecycle of the intra-balance movement.

10 The Payment Bank [Central Bank] receives the following message from T2S:

11 **Table 3-32: Messages from T2S [T2S.BPD.SETT.RBCB.04]**

Message Name	ISO Code	To/From T2S	Event	UDFS Chapter
IntraBalanceMovementInstruction	camt.066.001.01	From T2S	After validation of the inbound cash restriction by T2S	3.3.3.20

12

1 **3.10 UNRESERVATION OR UNBLOCKING OF CASH BALANCE**
2 **[T2S.BPD.SETT.UUCB]**

3 **3.10.1 OVERVIEW**

4 Unreserve or Unblock Cash balance refers to the process of unreserving or unblocking a certain amount of
5 cash to make it available for settlement of settlement instructions or for provision in view of transferring
6 back some cash to the RTGS account. It results in a transfer from one restricted cash balance into the
7 deliverable one within the same dedicated cash account.

8 It is to be noted that a restriction reference can be set to zero and can be reused via increases later on.

9 For details on the restriction of static data objects (e.g. securities accounts), refer to section “Static Data
10 Restriction Processes”.

11 This process is a variation of the process “Reservation or Blocking of Cash Balance
12 [T2S.BPD.SETT.RBCB]”. The steps highlighted in the diagram below require particular attention.

13 **Trigger:**

14 Instructing party needs to unblock or unreserve the cash balance

15 **Preconditions:**

- 16 • T2S dedicated cash account containing the cash balance to be unreserved or unblocked is known.
17 • Blocking or reservation reference is known to identify the cash balance to decrease.
18 • The restriction type Id that are referenced are known (set-up by the Central Bank or the T2S operator).

19 **T2S Instructing Party:**

20 There are two scenarios for the instruction of T2S:

- 21 • Scenario A: Central Bank instructs T2S.
22 • Scenario B: Payment Bank instructs T2S.

1 **3.10.2 BUSINESS PROCESS DIAGRAM**

2 **Figure 3-13: Business Process Diagram [T2S.BPD.SETT.UUCB]**

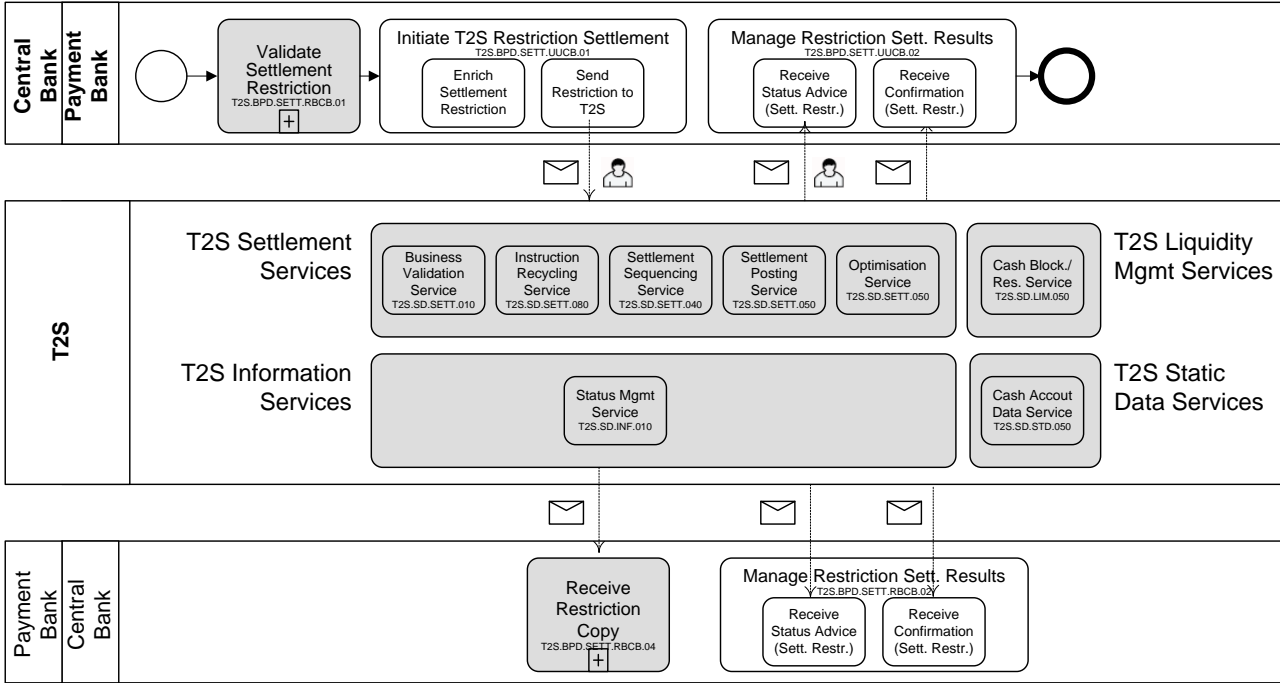

3

4 **3.10.3 BUSINESS PROCESS DESCRIPTION**

5 **3.10.3.1 INITIATE T2S RESTRICTION SETTLEMENT**

Reference ID	T2S.BPD.SETT.UUCB.01
--------------	----------------------

6 T2S Actors: Central Bank (Scenario A)/Payment Bank (Scenario B)

7 The Central Bank [Payment Bank] enriches the settlement restriction on cash balance with details required
 8 for settlement processing in T2S and sends the settlement restriction on cash balance to T2S.

9 References:

10 UDFS: Use Case “Send Settlement Restriction on Cash Balance” (Chapter 2.5)

11 GUI BFD: T2S.GUI.SESE.INX.0070

12 **3.10.3.1.1 Enrich Settlement Restriction**

Reference ID	T2S.BPD.SETT.UUCB.01.01
--------------	-------------------------

13 The Central Bank [Payment Bank] enriches the settlement restriction on cash balance with T2S specific
 14 information like reference of the dedicated cash account, amount of cash to be unblocked or unreserved. The
 15 balance “From” and balance “To” need to be filled with the restriction type Id already defined by the T2S

1 operator, or the Central Bank. The restriction reference³⁶ identifying the balance to be decreased is to be
 2 mentioned as well.

- 3 • In the balance “From”, the allowed Restriction type Ids are the ones pertaining to the “Blocking”³⁷ or
 4 “Reservation” processing types.
- 5 • In the balance “To”, the allowed Restriction type Id is the one pertaining to the “Deliverable” processing
 6 type only.

7 **Figure 3-14: Enrich Settlement Restriction [T2S.BPD.SETT.UUCB.01.01]**

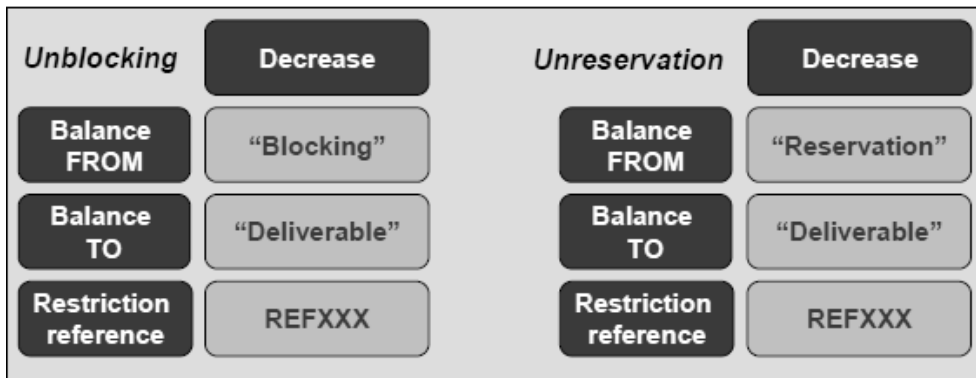

8

9 **3.10.3.1.2 Send Restriction to T2S**

Reference ID	T2S.BPD.SETT.UUCB.01.02
--------------	-------------------------

10 The Payment Bank [Central Bank] converts the settlement restriction on cash balance enriched with T2S
 11 specific information into the required message format and transmits it to T2S.

12 The instruction of T2S is also possible via the T2S GUI.

13 The Payment Bank [Central Bank] sends the following message to T2S:

14 **Table 3-33: Messages to T2S [T2S.BPD.SETT.UUCB.01.02]**

Message Name	ISO Code	To/From T2S	UDFS Chapter
IntraBalanceMovementInstruction	camt.066.001.01	To T2S	3.3.3.20

³⁶ The restriction reference was provided in the confirmation of the set-up of the blocked or reserved balance.

³⁷ “CoSD Blocking” not allowed

1 **3.10.3.2 T2S PROCESSING**

2 The **Business Validation Service (T2S.SD.SETT.010)** validates the received Intra-Balance Movement
 3 Instruction. After successful validation the **Cash Blocking and Reservation Service (T2S.SD.LIM.050)**
 4 then executes the unreservation or unblocking of the cash balance and informs the relevant parties
 5 (IntraBalanceMovementStatusAdvice and IntraBalanceMovementConfirmation).

6 The remaining settlement of the settlement restrictions follows the settlement lifecycle of a settlement
 7 instruction and involves the **Settlement Sequencing Service (T2S.SD.SETT.040)**, **Settlement Posting**
 8 **Service (T2S.SD.SETT.050)** and **Optimisation Service (T2S.SD.SETT.060)**. For details on these T2S
 9 services, refer to “Intra-CSD Settlement [T2S.BPD.SETT.ICSD]”.

10 **3.10.3.3 MANAGE RESTRICTION SETTLEMENT RESULTS**

Reference ID	T2S.BPD.SETT.UUCB.02
---------------------	----------------------

11 T2S Actors: Central Bank and Payment Bank (both scenarios)

12 The Central Bank [Payment Bank] receives the settlement related messages from T2S and initiates related
 13 internal processes.

14 References:

15 UDFS: Use case “Send Settlement Restriction on Cash Balance” (Chapter 2.5)

16 GUI BFD: T2S.GUI.SESE.INX.0070, T2S.GUI.SESE.INX.0010, T2S.GUI.SESE.INX.0020,
 17 T2S.GUI.SESE.INX.0030

18 **3.10.3.3.1 Receive Restriction Status Advice**

Reference ID	T2S.BPD.SETT.UUCB.02.01
---------------------	-------------------------

19 For this activity the Central Bank [Payment Bank] can receive status advices notifying for instance (non
 20 exhaustive):

- 21 • rejection of the settlement restriction on cash balance,
- 22 • acceptance of the settlement restriction on cash balance,
- 23 • eligibility failure of the settlement restriction on cash balance,
- 24 • provision check failure of the settlement restriction on cash balance

25 If T2S has been instructed via the T2S GUI the status is shown on the screen.

26 Following the message reception, other internal activities might be conducted such as:

- 1 • aligning the status of the settlement restriction on cash balance in the Central Bank or Payment Bank’s
- 2 systems with the status in T2S,
- 3 • triggering notification to Payment Banks in case the Central Bank instructed on their behalf,
- 4 • performing analysis after a failed instruction or a failed provision check.

5 The Central Bank [Payment Bank] receives the following messages from T2S:

6 **Table 3-34: Messages from T2S [T2S.BPD.SETT.UUCB.02.01]**

Message Name	ISO Code	From/To T2S	Event	UDFS Chapter
IntraBalanceMove mentStatusAdvice	camt.067.001.01	From T2S	Positive or failed business validation, Eligibility failure, Intra-day restriction, Failed provision check	3.3.3.21

7 **3.10.3.3.2 Receive Restriction Confirmation**

Reference ID	T2S.BPD.SETT.UUCB.02.02
---------------------	-------------------------

8 For this activity the Central Bank [Payment Bank]:

- 9 • receives in the case of unblocking from T2S one settlement confirmation indicating the settlement status
- 10 (i.e. full or partial³⁸ settlement),
- 11 • receives in case of unreservation from T2S one settlement confirmation indicating the settlement status
- 12 (i.e. full or partial³⁹ settlement).

13 Following the message reception, other internal activities might be conducted such as:

- 14 • aligning the status of the settlement restriction on cash balance in the Central Bank or Payment Bank’s
- 15 systems with the status in T2S,
- 16 • triggering notification to Payment Bank in case the Central Bank instructed on their behalf.

17

³⁸ Settled for the available blocked balance.

³⁹ Settled for the available reserved balance. No pre-emption mechanism.

1 The Central Bank [Payment Bank] receives the following messages from T2S:

2 **Table 3-35: Messages from T2S [T2S.BPD.SETT.UUCB.02.02]**

Name	ISO Code	From/To T2S	Event	UDFS Chapter
IntraBalanceMovementConfirmation	camt.068.001.01	From T2S	The cash unblocking or unreservation is fully settled, the cash unblocking or unreservation is partially settled	3.3.3.22

3

1 3.11 HOLD OF SETTLEMENT INSTRUCTION [T2S.BPD.SETT.HOLD]

2 3.11.1 OVERVIEW

3 This process describes the act of putting an instruction on Hold⁴⁰. The CSD or CSD Participant (if directly
4 connected) may use the Hold functionality to perform some regulatory checks or register the securities
5 before releasing the instruction for settlement. Putting on Hold the instruction does not prevent matching but
6 does prevent settlement.

7 For details on the release of a settlement instruction, refer to process “Release of Settlement Instruction
8 [T2S.BPD.SETT.RELE]”.

9 **Trigger:**

10 The CSD or CSD Participant receives details for putting on Hold the settlement instruction.

11 **Preconditions:**

12 The CSD or CSD Participant knows the reference of the instruction to be put on Hold.

13 **T2S Instructing Party:**

14 There are two scenarios for the instruction of T2S:

- 15 • Scenario A: CSD instructs T2S.
- 16 • Scenario B: CSD Participant instructs T2S.

⁴⁰ This PBD describes the process of Holding an instruction using a maintenance instruction, it is to be noted that a settlement instruction can be put on Hold also directly when instructing it via a “Party Hold” or “CSD Hold” indicator. The release process applies similarly.

It is also possible to set a settlement instruction on Hold based on a flag activated in the securities account reference data. (Automatic Hold) The instruction impacting this securities account will be put on “Party Hold” by T2S. The release process applies similarly.

Finally it is also possible to put a settlement instruction on “CSD Validation Hold” based on restriction type rules defined by the CSD. The release process applies similarly.

See also BPD for Intra-CSD settlement, BPD for Maintenance of restriction type, BPD Release instruction

1 **3.11.2 BUSINESS PROCESS DIAGRAM**

2 **Figure 3-15: Business Process Diagram [T2S.BPD.SETT.HOLD]**

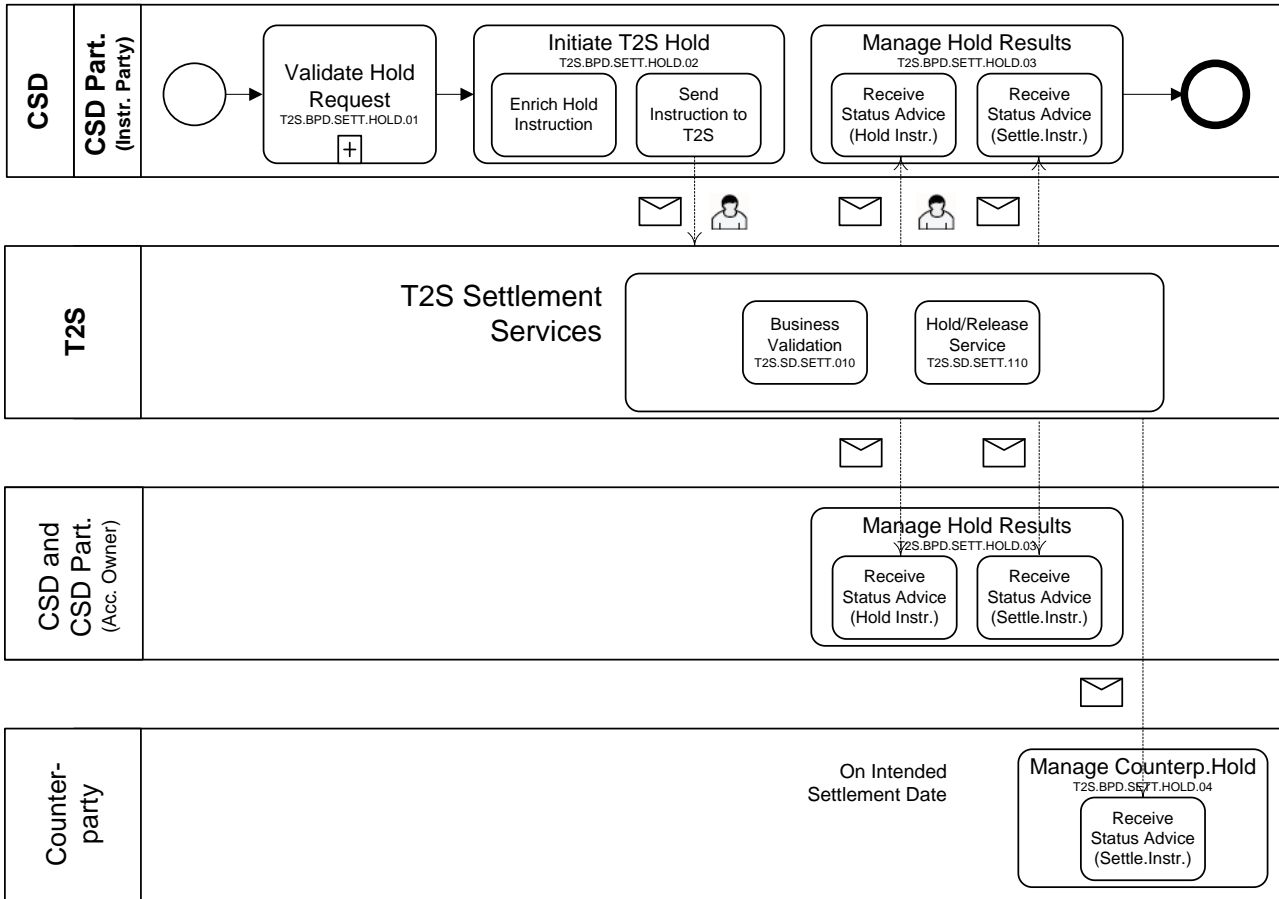

3

4 **3.11.3 BUSINESS PROCESS DESCRIPTION**

5 This Business Process Description is applicable to Scenario A and B unless otherwise noted. For the purpose
 6 of readability, the actor names in the text refer to Scenario A with the Scenario B actor indicated in square
 7 brackets.

8 **3.11.3.1 VALIDATE HOLD REQUEST**

Reference ID	T2S.BPD.SETT.HOLD.01
--------------	----------------------

9 T2S Actors: CSD (Scenario A)/CSD Participant (Scenario B)

10 The CSD [CSD Participant] checks all the details in the Hold Instruction against the reference data.

11

1 **3.11.3.2 INITIATE T2S HOLD**

Reference ID	T2S.BPD.SETT.HOLD.02
--------------	----------------------

2 T2S Actors: CSD (Scenario A)/CSD Participant (Scenario B)

3 The CSD [CSD Participant] enriches the Hold Instruction with details required for settlement processing in
 4 T2S and sends the Hold Instruction to T2S.

5 References:

6 UDFS: Use Case “Send Hold/Release Instruction” (Chapter 2.10)

7 GUI BFD: T2S.GUI.SESE.INX.0060

8 **3.11.3.2.1 Enrich Hold Instruction**

Reference ID	T2S.BPD.SETT.HOLD.02.01
--------------	-------------------------

9 The CSD [CSD Participant] enriches the Hold instruction with T2S specific information such as reference of
 10 the settlement instruction to be put on Hold, T2S securities account number and the type of Hold to be
 11 applied.

- 12 • The CSD can put an instruction on “CSD Hold”.
- 13 • The CSD can put an instruction on “Party Hold” on behalf of its participants (directly or indirectly
 14 connected).
- 15 • Directly connected CSD Participants can put an instruction on “Party Hold”.

16 Concurrent “Holds” can apply at the same time in T2S. Therefore a settlement instruction could potentially
 17 be set on Hold by both the CSD and the CSD Participant. If this is the case, both will need to release the
 18 instruction at a later stage to allow settlement.

19 **3.11.3.2.2 Send Instruction to T2S**

Reference ID	T2S.BPD.SETT.HOLD.02.02
--------------	-------------------------

20 The CSD [CSD Participant] converts the Hold instruction enriched with T2S specific information into the
 21 required message format and transmits it to T2S.

22 The instruction of T2S is also possible via the T2S GUI.

23

1 The CSD [CSD Participant] sends the following message to T2S:

2 **Table 3-36: Messages to T2S [T2S.BPD.SETT.HOLD.02.02]**

Message Name	ISO Code	To/From T2S	UDFS Chapter
SecuritiesSettlementConditionModificationRequestV03	sese.030.001.03	To T2S	3.3.8.10

3 **3.11.3.3 T2S PROCESSING**

4 The **Business Validation Service (T2S.SD.SETT.010)** validates the received hold instruction
 5 (SecuritiesSettlementConditionModificationRequest). After successful validation the **Hold/Release Service**
 6 **(T2S.SD.SETT.110)** then sets on hold the targeted settlement instruction according to the relevant type of
 7 hold specified in the hold instruction and informs the relevant parties
 8 (SecuritiesSettlementConditionModificationStatusAdvice and
 9 SecuritiesSettlementTransactionStatusAdvice).

10 **3.11.3.4 MANAGE HOLD RESULTS**

Reference ID	T2S.BPD.SETT.HOLD.03
--------------	----------------------

11 T2S Actors: CSD and CSD Participant (both Scenarios)

12 The CSD and CSD Participant receive the processing related messages from T2S and initiate related internal
 13 processes.

14 In both scenarios, the CSD and the CSD Participant receive the messages. When a CSD instructs T2S
 15 (Scenario A), the CSD Participant (if directly connected) can also receive these messages. Similarly, when
 16 the CSD Participant instructs T2S (Scenario B), the CSD can also receive the messages.

17 References:

18 UDFS: Use Case “Send Hold/Release Instruction” (Chapter 2.10)

19 GUI BFD: T2S.GUI.SESE.INX.0010, T2S.GUI.SESE.INX.0020, T2S.GUI.SESE.INX.0030

20 **3.11.3.4.1 Receive Status Advice (Hold Instruction)**

Reference ID	T2S.BPD.SETT.HOLD.03.01
--------------	-------------------------

21 The CSD and CSD Participant can receive status advices notifying of:

- 22 • rejection of the Hold Instruction,
- 23 • acceptance of the Hold Instruction,

- 1 • denial of the Hold Instruction,
 - 2 • execution of the Hold Instruction.
- 3 If T2S has been instructed via the T2S GUI the status is shown on the screen.
- 4 Following the message reception, other internal activities might be conducted such as:
- 5 • aligning the status of the Hold instruction in the CSD or CSD Participant’s systems with the status in
 - 6 T2S,
 - 7 • triggering notification to CSD Participants, e.g. if the CSD instructed on their behalf,
 - 8 • analysing the failed Hold restriction .

9 The CSD and CSD Participant receive the following messages from T2S:

10 **Table 3-37: Messages from T2S [T2S.BPD.SETT.HOLD.03.01]**

Message Name	ISO Code	To/From T2S	Event	UDFS Chapter
SecuritiesSettlementConditionModificationStatusAdviceV03	sese.031.001.03	From T2S	Positive or failed business validation, Referenced instruction is not eligible for the Hold, Execution of the Hold instruction	3.3.8.11

11 **3.11.3.4.2 Receive Status Advice (Settlement instruction)**

Reference ID	T2S.BPD.SETT.HOLD.03.02
--------------	-------------------------

12 The CSD and CSD Participant may receive status advice notifying that the settlement instruction referred to
 13 in the Hold Instruction is on Hold with the corresponding type of Hold that was specified in the Hold
 14 Instruction.

15 The type of Hold notified can be:

- 16 • “Party Hold” or,
- 17 • “CSD Hold”.

18 Following the message reception, other internal activities might be conducted such as:

- 19 • aligning the status of the settlement instruction in the CSD or CSD Participant’s systems with the status
- 20 in T2S,
- 21 • triggering notification to CSD Participants in case the CSD instructed on their behalf

22

1 The CSD and CSD Participant receive the following messages from T2S:

2 **Table 3-38: Messages from T2S [T2S.BPD.SETT.HOLD.03.02]**

Message Name	ISO Code	To/From T2S	Event	UDFS Chapter
SecuritiesSettlementTransactionStatus Advice	Sese.024.001.03	From T2S	Change of status of the settlement instruction to CSD Hold, Change of status of the settlement instruction to Party Hold	3.3.8.5

3 **3.11.3.5 MANAGE COUNTERPARTY HOLD**

Reference ID	T2S.BPD.SETT.HOLD.04
--------------	----------------------

4 T2S Actors: Counterparty

5 The Counterparty receives the status advice of a settlement instruction on intended settlement date, if the
6 instruction that is put on Hold is matched with the counterparty instruction.

7 References:

8 UDFS: Use Case “Send Hold/Release Instruction” (Chapter 2.10)

9 GUI BFD: T2S.GUI.SESE.INX.0010, T2S.GUI.SESE.INX.0020, T2S.GUI.SESE.INX.0030

10 **3.11.3.5.1 Receive Status Advice (Settlement Instruction)**

Reference ID	T2S.BPD.SETT.HOLD.04.01
--------------	-------------------------

11 The Counterparty may receive a status advice of a Settlement Instruction notifying that its counterparty
12 settlement instruction is on Hold. The Counterparty receives this notification if its instruction is matched at
13 the intended settlement date. The message reception initiates the relevant processes on the counterparty side.

14 The Counterparty receives the following message from T2S:

15 **Table 3-39: Messages from T2S [T2S.BPD.SETT.HOLD.04.01]**

Message Name	ISO Code	To/From T2S	Event	UDFS Chapter
SecuritiesSettlementTransactionStatus Advice	Sese.024.001.03	From T2S	Change of status of the settlement instruction of the counterparty to Hold	3.3.8.5

1 **3.12 RELEASE OF SETTLEMENT INSTRUCTION [T2S.BPD.SETT.RELE]**

2 **3.12.1 OVERVIEW**

3 This process describes the act of releasing an instruction following its Hold. The CSD or CSD Participant (if
4 directly connected) releases the instruction once the business process behind the holding of the instruction
5 has been completed and the settlement of the Instruction can occur. It could be for instance after registration
6 of shares or other regulatory checks.

7 For details on the holding of a settlement instruction, refer to process “Hold of Settlement Instruction
8 [T2S.BPD.SETT.HOLD]”.

9 For details on the CoSD release, refer to process “Administration of Conditional Securities Delivery
10 [T2S.BPD.SETT.COSD]”.

11 **Trigger:**

12 The CSD or CSD Participant receives details for releasing the settlement Instruction

13 **Preconditions:**

14 The CSD or CSD Participant knows the reference of Instruction to be released

15 **T2S Instructing Party:**

16 There are two scenarios for the instruction of T2S:

- 17 • Scenario A: CSD instructs T2S.
18 • Scenario B: CSD Participant instructs T2S.

1 **3.12.2 BUSINESS PROCESS DIAGRAM**

2 **Figure 3-16: Business Process Diagram [T2S.BPD.SETT.RELE]**

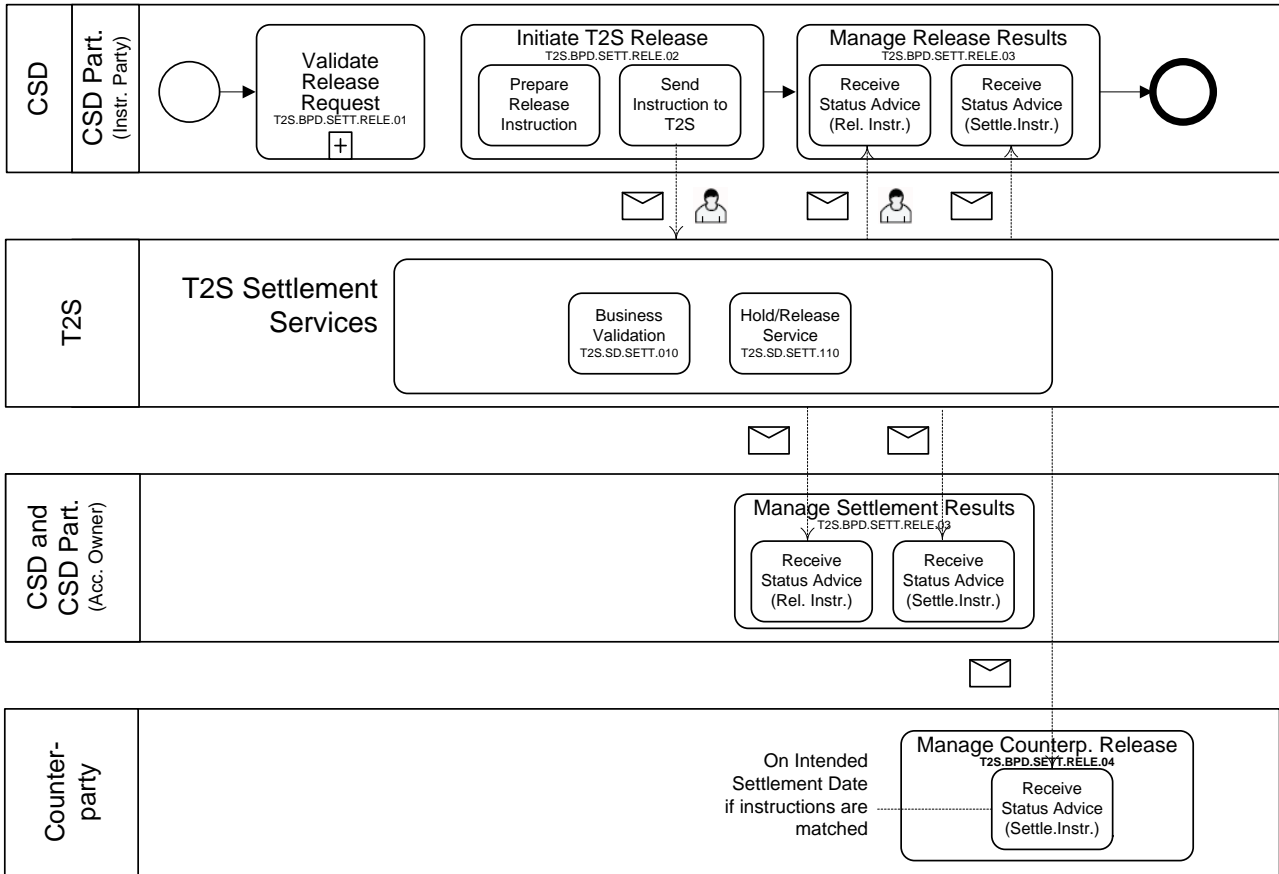

3

4 **3.12.3 BUSINESS PROCESS DESCRIPTION**

5 This Business Process Description is applicable to Scenario A and B unless otherwise noted. For the purpose
 6 of readability, the actor names in the text refer to Scenario A with the Scenario B actor indicated in square
 7 brackets.

8 **3.12.3.1 VALIDATE RELEASE REQUEST**

Reference ID	T2S.BPD.SETT.RELE.01
--------------	----------------------

9 T2S Actors: CSD (Scenario A)/CSD Participant (Scenario B)

10 The CSD [CSD Participant] checks all the details in the Release Instruction against the reference data.

11 **3.12.3.2 INITIATE T2S RELEASE**

Reference ID	T2S.BPD.SETT.RELE.02
--------------	----------------------

12 T2S Actors: CSD (Scenario A)/CSD Participant (Scenario B)

1 The CSD [CSD Participant] enriches the Release Instruction with details required for settlement processing
 2 in T2S and sends the Release Instruction to T2S.

3 References:

4 UDFS: Use Case “Send Hold/Release Instruction” (Chapter 2.10)

5 GUI BFD: T2S.GUI.SESE.INX.0060

6 **3.12.3.2.1 Prepare Release Instruction**

Reference ID	T2S.BPD.SETT.RELE.02.01
--------------	-------------------------

7 The CSD [CSD Participant] enriches the Release Instruction with T2S specific information such as reference
 8 of the Settlement Instruction to be released, T2S securities account number and the type of Release to be
 9 applied.

- 10 • CSD can release the “CSD Hold”.
- 11 • CSD can release the “Party Hold” on behalf of its participants (Directly or indirectly connected).
- 12 • CSD can release the “CSD Validation Hold”.
- 13 • Directly connected CSD Participants can release the “Party Hold”.

14 The execution of the Release Instruction will result in allowing the settlement of the underlying Settlement
 15 Instruction if no other concurrent “Holds” apply to the same Settlement Instruction or to the matching
 16 counterparty instruction, if any.

17 **3.12.3.2.2 Send Instruction to T2S**

Reference ID	T2S.BPD.SETT.RELE.02.02
--------------	-------------------------

18 The CSD [CSD Participant] converts the Release Instruction enriched with T2S specific information into the
 19 required message format and transmits it to T2S.

20 The instruction of T2S is also possible via the T2S GUI.

21

1 The CSD [CSD Participant] sends the following message to T2S:

2 **Table 3-40: Messages to T2S [T2S.BPD.SETT.RELE.02.02]**

Message Name	ISO Code	To/From T2S	Event	UDFS Chapter
SecuritiesSettlementConditionModificationRequestV03	sese.030.001.03	To T2S	-	3.3.8.10

3 **3.12.3.3 T2S PROCESSING**

4 The **Business Validation Service (T2S.SD.SETT.010)** validates the received hold instruction
 5 (SecuritiesSettlementConditionModificationRequest). After successful validation the **Hold/Release Service**
 6 **(T2S.SD.SETT.110)** then releases for the targeted settlement instruction the relevant type of hold specified
 7 in the release instruction and informs the relevant parties
 8 (SecuritiesSettlementConditionModificationStatusAdvice and
 9 SecuritiesSettlementTransactionStatusAdvice).

10 **3.12.3.4 MANAGE RELEASE RESULTS**

Reference ID	T2S.BPD.SETT.RELE.03
--------------	----------------------

11 T2S Actors: CSD and CSD Participant (Both Scenarios)

12 The CSD and CSD Participant receive the settlement related messages from T2S and initiate related internal
 13 processes.

14 In both scenarios, the CSD and the CSD Participant receive the messages. When a CSD instructs T2S
 15 (Scenario A), the CSD Participant (if directly connected) can also receive these messages. Similarly, when
 16 the CSD Participant instructs T2S (Scenario B), the CSD can also receive the messages.

17 References:

18 UDFS: Use Case “Send Hold/Release Instruction” (Chapter 2.10)

19 GUI BFD: T2S.GUI.SESE.INX.0010, T2S.GUI.SESE.INX.0020, T2S.GUI.SESE.INX.0030

20 **3.12.3.4.1 Receive Status Advice (Release Instruction)**

Reference ID	T2S.BPD.SETT.RELE.03.01
--------------	-------------------------

21 The CSD and CSD Participant can receive status advices notifying:

- 22 • rejection of the Release Instruction,
- 23 • acceptance of the Release Instruction,

- 1 • denial of the Release Instruction,
 - 2 • execution of the Release Instruction.
- 3 If T2S has been instructed via the T2S GUI the status is shown on the screen.
- 4 Following the message reception, other internal activities might be conducted such as:
- 5 • aligning the status of the Release Instruction in the CSD or CSD Participant’s systems with the status in
 - 6 T2S,
 - 7 • triggering notification to CSD Participants, e.g. if the CSD instructed on their behalf,
 - 8 • analysing the failed Release Instruction.
- 9 The CSD and CSD Participant receive the following messages from T2S:

10 **Table 3-41: Messages from T2S [T2S.BPD.SETT.RELE.03.01]**

Message Name	ISO Code	To/From T2S	Event	UDFS Chapter
SecuritiesSettlementConditionModificationStatusAdviceV03	sese.031.001.03	From T2S	Positive or failed business validation, Referenced Instruction is not eligible for the Release, Execution of the Release Instruction	3.3.8.11

11 **3.12.3.4.2 Receive Status Advice (Settlement Instruction)**

Reference ID	T2S.BPD.SETT.RELE.03.02
--------------	-------------------------

- 12 The CSD and CSD Participant may receive status advice notifying the fact that the Settlement Instruction
- 13 referred to in the Release Instruction is “Released” for the type of Hold mentioned in the Release Instruction.
- 14 The instruction can be fully released or another Hold can remain.
- 15 Following the message reception, other internal activities might be conducted such as:
- 16 • aligning the status of the settlement Instruction in the CSD’s or CSD Participant’s systems with the
 - 17 status in T2S,
 - 18 • triggering notification to CSD Participants, e.g. if the CSD instructed on their behalf.
- 19

1 The CSD and CSD Participant receive the following messages from T2S:

2 **Table 3-42: Messages from T2S [T2S.BPD.SETT.RELE.03.02]**

Message Name	ISO Code	To/From T2S	Event	UDFS Chapter
SecuritiesSettlementTransactionStatus Advice	Sese.024.001.03	From T2S	Execution of the Release Instruction, Execution of the Release Instruction	3.3.8.5

3 **3.12.3.5 MANAGE COUNTERPARTY RELEASE**

Reference ID	T2S.BPD.SETT.RELE.04
--------------	----------------------

4 T2S Actors: Counterparty

5 The Counterparty receives settlement related messages and initiates the relevant processes.

6 References:

7 UDFS: Use Case “Send Hold/Release Instruction” (Chapter 2.10)

8 GUI BFD: T2S.GUI.SESE.INX.0010, T2S.GUI.SESE.INX.0020, T2S.GUI.SESE.INX.0030

9 **3.12.3.5.1 Receive Status Advice (Settlement Instruction)**

Reference ID	T2S.BPD.SETT.RELE.04.01
--------------	-------------------------

10 The Counterparty receives the status advice of a settlement instruction on or after the intended settlement date, if the Instruction was released on or after intended settlement date and matched with this party’s instruction. (i.e. the Counterparty already received a notification from T2S for the Hold in the first place).

13 The message reception initiates the relevant processes on the Counterparty side.

14 The Counterparty receives the following message from T2S:

15 **Table 3-43: Messages from T2S [T2S.BPD.SETT.RELE.04.01]**

Message Name	ISO Code	To/From T2S	Event	UDFS Chapter
SecuritiesSettlementTransactionStatus Advice	Sese.024.001.03	From T2S	Execution of the Release Instruction of the counterparty	3.3.8.5

1 **3.13 CANCELLATION OF SETTLEMENT INSTRUCTION [T2S.BPD.SETT.CINS]**

2 **3.13.1 OVERVIEW**

3 This process describes the act of cancelling a Settlement Instruction using a Cancellation Instruction. T2S
4 cancels an unmatched Settlement Instruction upon the reception of a valid Cancellation Instruction from the
5 CSD or CSD Participant. For matched Settlement Instructions T2S requires a cancellation of both Settlement
6 Instructions (i.e. two Cancellation Instructions or a matched Cancellation Instruction). A Cancellation
7 Instruction has its own life cycle and own instruction statuses that differ from the one of a Settlement
8 Instruction.

9 **Trigger:**

10 A CSD or CSD Participant identifies the need to cancel an instruction.

11 **Preconditions:**

12 A valid Settlement Instruction exists in T2S and it is not fully settled neither cancelled.

13 **T2S Instructing Party:**

14 There are two scenarios for the instruction of T2S:

- 15 • Scenario A: CSD instructs T2S (on its own behalf, or on behalf of a participant).
16 • Scenario B: CSD Participant instructs T2S.

1 **3.13.2 BUSINESS PROCESS DIAGRAM**

2 **Figure 3-17: Business Process Diagram [T2S.BPD.SETT.CINS]**

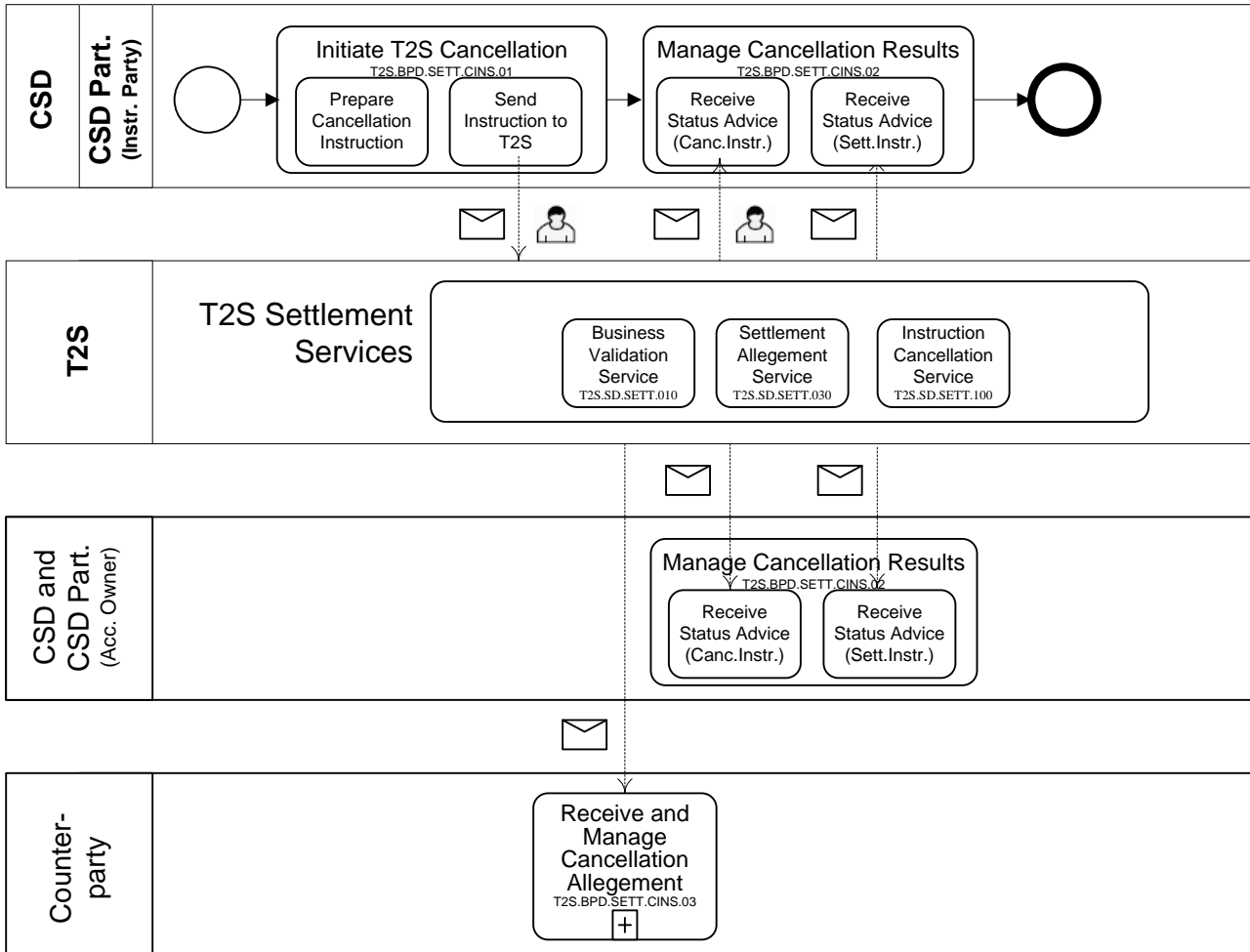

3

4 **3.13.3 BUSINESS PROCESS DESCRIPTION**

5 This Business Process Description is applicable to Scenario A and B unless otherwise noted. For the purpose
6 of readability, the actor names in the text refer to Scenario A with the Scenario B actor indicated in square
7 brackets.

8 **3.13.3.1 INITIATE T2S CANCELLATION**

Reference ID	T2S.BPD.SETT.CINS.01
--------------	----------------------

9 T2S Actors: CSD (Scenario A)/CSD Participant (Scenario B)

10 The CSD [CSD Participant] collects the information required to create a Cancellation Instruction and sends it
11 to T2S.

12 References:

1 UDFS: Use Case “Send Cancellation Instruction of a Settlement Instruction or settlement restriction on
 2 securities position” (Chapter 2.11)
 3 GUI BFD: T2S.GUI.SESE.INX.0050

4 **3.13.3.1.1 Prepare Cancellation Instruction**

Reference ID	T2S.BPD.SETT.CINS.01.01
--------------	-------------------------

5 The CSD [CSD Participant] prepares a Cancellation Instruction with the information and format required by
 6 T2S.

7 The Cancellation Instruction will include the reference of the to-be-cancelled instruction (i.e. T2S reference
 8 or the combination of T2S Actor reference and couples of Party BIC identifying the Instructing Party) so that
 9 T2S can unambiguously identify this instruction. In case the T2S actor wants to cancel an already matched
 10 Settlement Instruction with one cancellation, it will have to specify the T2S Actor reference (plus couples of
 11 Party BIC identifying the Instructing Party) of the already matched instruction.

12 **3.13.3.1.2 Send Instruction to T2S**

Reference ID	T2S.BPD.SETT.CINS.01.02
--------------	-------------------------

13 The CSD [CSD Participant] sends the Cancellation Instruction to T2S.

14 The instruction of T2S is also possible via the T2S GUI.

15 The CSD [CSD Participant] sends the following message to T2S:

16 **Table 3-44: Messages to T2S [T2S.BPD.SETT.CINS.01.02]**

Message Name	ISO Code	To/From T2S	UDFS Chapter
SecuritiesTransactionCancellationRequestV03 ⁴¹	sese.020.001.03	To T2S	3.3.8.1

17 **3.13.3.2 T2S PROCESSING**

18 The **Business Validation Service (T2S.SD.SETT.010)** validates the received cancellation instruction
 19 (SecuritiesTransactionCancellationRequest). After successful validation the **Instruction Cancellation**
 20 **Service (T2S.SD.SETT.100)** executes the cancellation according to the defined rules and sends the related
 21 status advices on the cancellation instruction (SecuritiesTransactionCancellationRequestStatusAdvice) and
 22 the settlement instruction (SecuritiesSettlementTransactionStatusAdvice) to the relevant parties. If the
 23 instruction that should be cancelled is matched and the cancellation is not sent as already matched for both

⁴¹ Used to cancel Settlement Instructions as well as Intra-position Movements (i.e. settlement restrictions on securities position)

1 legs, the **Allegation Service (T2S.SD.SETT.030)** informs the counterparty
 2 (SecuritiesSettlementTransactionStatusAdvice) that a cancellation of the matched Settlement Instruction has
 3 been requested (unless the counterparty has already instructed the cancellation from its side).

4 **3.13.3.3 MANAGE CANCELLATION RESULTS**

Reference ID	T2S.BPD.SETT.CINS.02
--------------	----------------------

5 T2S Actors: CSD and CSD Participant (Both Scenarios)

6 The CSD and CSD Participant receive the status advice messages generated by T2S for the Cancellation
 7 Instruction and for the Settlement Instruction.

8 In both scenarios, the CSD and the CSD Participant receive the messages. When a CSD instructs T2S
 9 (Scenario A), the CSD Participant (if directly connected) can also receive these messages. Similarly, when
 10 the CSD Participant instructs T2S (Scenario B), the CSD can also receive the messages.

11 In the case where the CSD acts on its own behalf, T2S does not send any message flows to the CSD
 12 Participant.

13 The fact that the Settlement Instruction is on hold or linked to another instruction does not avoid its
 14 cancellation. Nevertheless, a Settlement Instruction on CoSD Hold can only be cancelled by the
 15 Administering Party or CSD and not by a CSD Participant.

16 References:

17 UDFS: Use Case “Send Cancellation Instruction of a Settlement Instruction or settlement restriction on
 18 securities position” (Chapter 2.11)

19 GUI BFD: T2S.GUI.SESE.INX.0050

20 **3.13.3.3.1 Receive Status Advice (Cancellation Instruction)**

Reference ID	T2S.BPD.SETT.CINS.02.01
--------------	-------------------------

21 The CSD and CSD Participant receive status advice messages for every change of status to the Cancellation
 22 Instruction in T2S. Additionally this activity receives the reason code update in case the Cancellation
 23 Instruction is denied.

24 If T2S has been instructed via the T2S GUI the status is shown on the screen.

25

26

1 The CSD and CSD Participant receive the following messages from T2S:

2 **Table 3-45: Messages from T2S [T2S.BPD.SETT.CINS.02.01]**

Message Name	ISO Code	To/From T2S	Event	UDFS Chapter
SecuritiesTransactionCancellationRequestStatusAdviceV03	sese.027.001.03	From T2S	Change in status/reason code of the Cancellation Instruction	3.3.8.7

3 The message reports the statuses and relevant reason codes of a Cancellation Instruction.

4 Following the message reception, other internal activities might be conducted such as aligning the status of
 5 the Cancellation Instruction in the CSD’s or CSD Participant’s systems with the status in T2S. In case of
 6 rejection or denial an analysis can be launched before re-submitting a cancellation.

7 **3.13.3.3.2 Receive Status Advice (Settlement Instruction)**

Reference ID	T2S.BPD.SETT.CINS.02.02
--------------	-------------------------

8 The CSD and CSD Participant receive status advice messages for every change of the cancellation status of
 9 the referenced Settlement Instruction in T2S as well as any reason code update of the instruction’s
 10 cancellation status (e.g. status advice message reporting the reason code that a cancellation is awaiting from
 11 the counterparty in case the Settlement Instruction was matched).

12 The CSD could also receive status advice messages related to the cancellation of the realignment instructions
 13 related to the Settlement Instruction, if any.

14 The CSD and CSD Participant receive the following message from T2S:

15 **Table 3-46: Messages from T2S [T2S.BPD.SETT.CINS.02.02]**

Message Name	ISO Code	To/From T2S	Event	UDFS Chapter
SecuritiesSettlementTransactionStatusAdvice	Sese.024.001.03	From T2S	Change in status/reason code of the Settlement Instruction (i.e. either “instruction cancelled” or “pending cancellation, awaiting confirmation from the counterparty”	3.3.8.5

16 The message reports the statuses and relevant reason codes of a Settlement Instruction.

1 Following the message reception, other internal activities might be conducted such as:

- 2 • aligning the status of the Settlement Instruction on securities/cash in the CSD’s or CSD Participant’s
- 3 systems with the status in T2S,
- 4 • contacting the counterparty in case bilateral cancellation is required (i.e. Settlement Instruction has been
- 5 matched),
- 6 • sending amendment instructions of instructions that were linked to the cancelled instruction to modify
- 7 the link indicators,
- 8 • triggering notification to third parties down the chain.

9 **3.13.3.4 RECEIVE AND MANAGE CANCELLATION ALLEGEMENT**

Reference ID	T2S.BPD.SETT.CINS.03
--------------	----------------------

10 T2S Actors: Counterparty

11 The Counterparty receives the status advice message generated by T2S to report that a cancellation of the
 12 matched Settlement Instruction has been requested. Additionally, the Counterparty analyses whether a
 13 Cancellation Instruction of the Settlement Instruction is needed.

14 The Counterparty receives the following message from T2S:

15 **Table 3-47: Messages from T2S [T2S.BPD.SETT.CINS.03]**

Message Name	ISO Code	To/From T2S	Event	UDFS Chapter
SecuritiesSettlementTransactionStatus Advice	Sese.024.001.03	From T2S	Change in status/reason code of the Settlement Instruction (i.e. “cancellation requested”)	3.3.8.5

16 The message reports the statuses and relevant reason codes of a Settlement Instruction.

17 Following the message reception, other internal activities might be conducted such as:

- 18 • aligning the status of the Settlement Instruction in the CSD/CSD Participant’s systems with the status in
- 19 T2S,
- 20 • contacting the counterparty to understand the reason for a cancellation,
- 21 • triggering notification to third parties (e.g. client of the CSD Participant),
- 22 • initiating a cancellation might be required.

23

1 References:

2 UDFS: Use Case “Send Cancellation Instruction of a Settlement Instruction or settlement restriction on
3 securities position” (Chapter 2.11)

4 Cancellation of Intra-Position Movement [T2S.BPD.SETT.CIPM]

5

1 **3.14 CANCELLATION OF INTRA-POSITION MOVEMENT**
2 **[T2S.BPD.SETT.CIPM]**

3 **3.14.1 OVERVIEW**

4 This process describes the act of cancelling an Intra-position Movement (i.e. settlement restriction on
5 securities position) using a Cancellation Instruction. T2S cancels an Intra-position Movement upon the
6 reception of a valid Cancellation Instruction from the CSD or CSD Participant. A Cancellation Instruction
7 has its own life cycle and own instruction statuses that differ from the one of an Intra-position Movement.

8 **Trigger:**

9 A CSD or CSD Participant identifies the need to cancel an Intra-position Movement.

10 **Preconditions:**

11 A valid Intra-position Movement exists in T2S and it is not fully settled neither cancelled.

12 **T2S Instructing Party:**

13 There are two scenarios for the instruction of T2S:

- 14 • Scenario A: CSD instructs T2S (on its own behalf, or on behalf of a participant).
15 • Scenario B: CSD Participant instructs T2S.

1 **3.14.2 BUSINESS PROCESS DIAGRAM**

2 **Figure 3-18: Business Process Diagram [T2S.BPD.SETT.CIPM]**

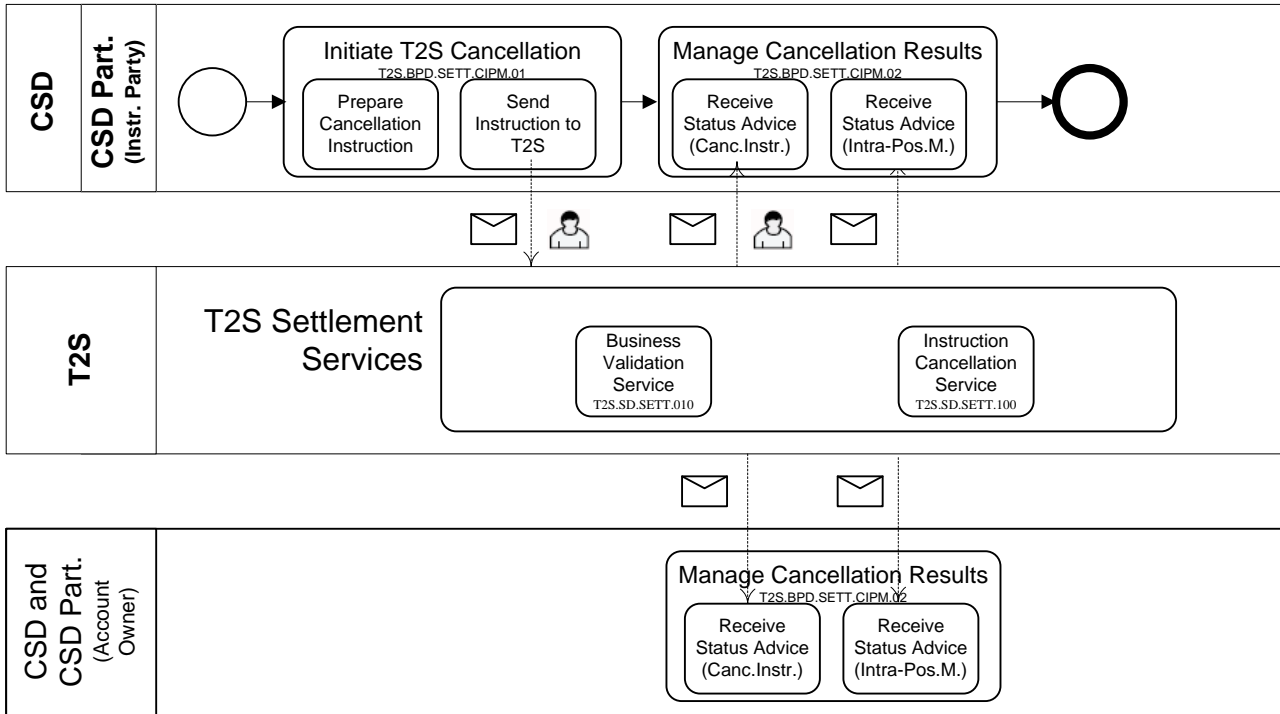

3

4 **3.14.3 BUSINESS PROCESS DESCRIPTION**

5 This Business Process Description is applicable to Scenario A and B unless otherwise noted. For the purpose
 6 of readability, the actor names in the text refer to Scenario A with the Scenario B actor indicated in square
 7 brackets.

8 **3.14.3.1 INITIATE T2S CANCELLATION**

Reference ID	T2S.BPD.SETT.CIPM.01
--------------	----------------------

9 T2S Actors: CSD (Scenario A)/CSD Participant (Scenario B)

10 The CSD [CSD Participant] collects the information required to create a Cancellation Instruction and sends it
 11 to T2S.

12 References:

13 UDFS: Use Case “Send Cancellation Instruction of a Settlement Instruction or settlement restriction on
 14 securities position” (Chapter 2.11)

15 GUI BFD: T2S.GUI.SESE.INX.0050

16 **3.14.3.1.1 Prepare Cancellation Instruction**

Reference ID	T2S.BPD.SETT.CIPM.01.01
--------------	-------------------------

1 The CSD [CSD Participant] prepares a Cancellation Instruction with the information and format required by
2 T2S.

3 The Cancellation Instruction will include the reference of the to-be-cancelled instruction (i.e. T2S reference
4 or the combination of T2S Actor reference and couples of Party BIC identifying the Instructing Party) so that
5 T2S can unambiguously identify this instruction

6 **3.14.3.1.2 Send Instruction to T2S**

Reference ID	T2S.BPD.SETT.CIPM.01.02
--------------	-------------------------

7 The CSD [CSD Participant] sends the Cancellation Instruction to T2S.

8 The instruction of T2S is also possible via the T2S GUI.

9 The CSD [CSD Participant] sends the following message to T2S:

10

1 **Table 3-48: Messages to T2S [T2S.BPD.SETT.CIPM.01.02]**

Message Name	ISO Code	To/From T2S	UDFS Chapter
SecuritiesTransactionCancellationRequestV03 ⁴²	sese.020.001.03	To T2S	3.3.8.1

2 **3.14.3.2 T2S PROCESSING**

3 The **Business Validation Service (T2S.SD.SETT.010)** validates the received cancellation instruction
 4 (SecuritiesTransactionCancellationRequest). After successful validation the **Instruction Cancellation**
 5 **Service (T2S.SD.SETT.100)** executes the cancellation of the intra-position movement according to the
 6 defined rules and sends the related status advices on the cancellation instruction
 7 (SecuritiesTransactionCancellationRequestStatusAdvice) and the Intra-Position Movement instruction
 8 (IntraPositionMovementStatusAdvice) to the relevant parties.

9 **3.14.3.3 MANAGE CANCELLATION RESULTS**

Reference ID	T2S.BPD.SETT.CIPM.02
--------------	----------------------

10 T2S Actors: CSD and CSD Participant (Both Scenarios)

11 The CSD and CSD Participant receive the status advice messages generated by T2S for the Cancellation
 12 Instruction and for the Intra-position Movement.

13 In both scenarios, the CSD and the CSD Participant receive the messages. When a CSD instructs T2S
 14 (Scenario A), the CSD Participant (if directly connected) can also receive these messages. Similarly, when
 15 the CSD Participant instructs T2S (Scenario B), the CSD can also receive the messages.

16 In the case where the CSD acts on its own behalf, T2S does not send any message flows to the CSD
 17 Participant.

18 The fact that the Intra-position Movement is linked to another instruction does not avoid its cancellation.

19 References:

20 UDFS: Use Case “Send Cancellation Instruction of a Settlement Instruction or settlement restriction on
 21 securities position” (Chapter 2.11)

22 GUI BFD: T2S.GUI.SESE.INX.0050

23

⁴² Used to cancel Intra-Position Movement as well as Settlement Instructions

1 **3.14.3.3.1 Receive Status Advice (Cancellation Instruction)**

Reference ID	T2S.BPD.SETT.CIPM.02.01
--------------	-------------------------

2 The CSD and CSD Participant receive status advice messages for every change of status to the Cancellation
 3 Instruction in T2S. Additionally this activity receives the reason code update in case the Cancellation
 4 Instruction is denied.

5 If T2S has been instructed via the T2S GUI the status is shown on the screen.

6 The CSD and CSD Participant receive the following messages from T2S:

7 **Table 3-49: Messages from T2S [T2S.BPD.SETT.CIPM.02.01]**

Message Name	ISO Code	To/From T2S	Event	UDFS Chapter
SecuritiesTransactionCancellationRequestStatusAdviceV03	sese.027.001.03	From T2S	Change in status/reason code of the Cancellation Instruction	3.3.8.7

8 The message reports the statuses and relevant reason codes of a Cancellation Instruction.

9 Following the message reception, other internal activities might be conducted such as aligning the status of
 10 the Cancellation Instruction in the CSD's or CSD Participant's systems with the status in T2S. In case of
 11 rejection or denial an analysis can be launched before re-submitting a cancellation.

12 **3.14.3.3.2 Receive Status Advice (Intra-Position movement)**

Reference ID	T2S.BPD.SETT.CIPM.02.02
--------------	-------------------------

13 The CSD and CSD Participant receive status advice messages for every change of the cancellation status of
 14 the referenced Intra-position Movement in T2S as well as any reason code update of its cancellation status.

15 The CSD and CSD Participant receive the following message from T2S:

16 **Table 3-50: Messages from T2S [T2S.BPD.SETT.CIPM.02.02]**

Message Name	ISO Code	To/From T2S	Event	UDFS Chapter
IntraPositionMovementStatusAdvice	semt.014.001.03	From T2S	Change in status of the settlement restriction on securities position ("cancelled")	3.3.7.3

17 The message reports the statuses and relevant reason codes of an Intra-position Movement.

18 Following the message reception, other internal activities might be conducted such as:

- 1 • aligning the status of the Intra-position Movement in the CSD's or CSD Participant's systems with the
- 2 status in T2S,
- 3 • sending amendment instructions of instructions that were linked to the cancelled instruction to modify
- 4 the link indicators,
- 5 • triggering notification to third parties down the chain.
- 6

1 **3.15 CANCELLATION OF INTRA-BALANCE MOVEMENT**
2 **[T2S.BPD.SETT.CIBM]**

3 **3.15.1 OVERVIEW**

4 This process describes the act of cancelling an Intra-balance Movement (i.e. settlement restriction on cash
5 balance) using a Cancellation Instruction. T2S cancels an Intra-balance Movement upon the reception of a
6 valid Cancellation Instruction from the Central Bank or Central Bank Participant. A Cancellation Instruction
7 has its own life cycle and own instruction statuses that differ from the one of an Intra-balance Movement.

8 **Trigger:**

9 A Central Bank or Central Bank Participant identifies the need to cancel an Intra-balance Movement.

10 **Preconditions:**

11 A valid Intra-balance Movement exists in T2S and it is not fully settled neither cancelled.

12 **T2S Instructing Party:**

13 There are two scenarios for the instruction of T2S:

- 14 • Scenario A: Central Bank instructs T2S (on its own behalf, or on behalf of a participant).
15 • Scenario B: Central Bank Participant instructs T2S.

1 **3.15.2 BUSINESS PROCESS DIAGRAM**

2 **Figure 3-19: Business Process Diagram [T2S.BPD.SETT.CIBM]**

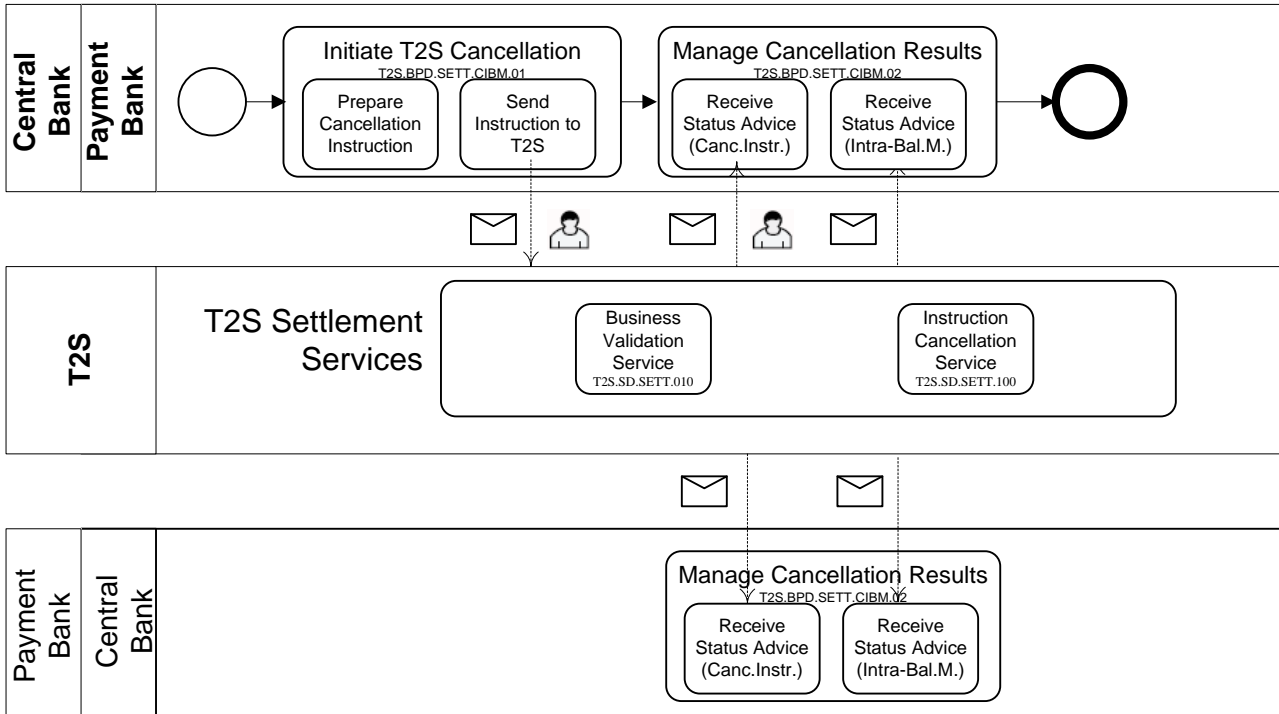

3

4 **3.15.3 BUSINESS PROCESS DESCRIPTION**

5 This Business Process Description is applicable to Scenario A and B unless otherwise noted. For the purpose
 6 of readability, the actor names in the text refer to Scenario A with the Scenario B actor indicated in square
 7 brackets.

8 **3.15.3.1 INITIATE T2S CANCELLATION**

Reference ID	T2S.BPD.SETT.CIBM.01
--------------	----------------------

9 T2S Actors: Central Bank (Scenario A)/Payment Bank (Scenario B)

10 The Central Bank [Payment Bank] collects the information required to create a Cancellation Instruction and
 11 sends it to T2S.

12 References:

13 UDFS: Use Case “Send Cancellation Instruction of a Settlement restriction on cash balance” (Chapter 2.12)

14 GUI BFD: T2S.GUI.SESE.INX.0050

15 **3.15.3.1.1 Prepare Cancellation Instruction**

Reference ID	T2S.BPD.SETT.CIBM.01.01
--------------	-------------------------

1 The Central Bank [Payment Bank] prepares a Cancellation Instruction with the information and format
 2 required by T2S.

3 The Cancellation Instruction will include the reference of the to-be-cancelled instruction (i.e. T2S reference
 4 or the combination of T2S Actor reference and couples of Party BIC identifying the Instructing Party) so that
 5 T2S can unambiguously identify this instruction

6 **3.15.3.1.2 Send Instruction to T2S**

Reference ID	T2S.BPD.SETT.CIBM.01.02
--------------	-------------------------

7 The Central Bank [Payment Bank] sends the Cancellation Instruction to T2S.

8 The instruction of T2S is also possible via the T2S GUI.

9 The Central Bank [Payment Bank] sends the following message to T2S:

10 **Table 3-51: Messages to T2S [T2S.BPD.SETT.CIBM.01.02]**

Message Name	ISO Code	To/From T2S	UDFS Chapter
IntraBalanceMovementCancellationRequest	camt.074.001.01	To T2S	3.3.3.28

11 **3.15.3.2 T2S PROCESSING**

12 The **Business Validation Service (T2S.SD.SETT.010)** validates the received cancellation instruction
 13 (IntraBalanceMovementCancellationRequest). After successful validation the **Instruction Cancellation**
 14 **Service (T2S.SD.SETT.100)** executes the cancellation of the intra-balance movement according to the
 15 defined rules and sends the related status advices on the cancellation instruction
 16 (IntraBalanceMovementCancellationRequestStatusAdvice) and the Intra-Balance Movement instruction
 17 (IntraBalanceMovementStatusAdvice).

18 **3.15.3.3 MANAGE CANCELLATION RESULTS**

Reference ID	T2S.BPD.SETT.CIBM.02
--------------	----------------------

19 T2S Actors: Central Bank and Payment Bank (Both Scenarios)

20 The Central Bank and Payment Bank receive the status advice messages generated by T2S for the
 21 Cancellation Instruction and for the Intra-balance Movement.

1 In both scenarios, the Central Bank and Payment Bank receive the messages. When a Central Bank instructs
 2 T2S (Scenario A), the Payment Bank (if directly connected) can also receive these messages. Similarly,
 3 when the Payment Bank instructs T2S (Scenario B), the Central Bank can also receive the messages.

4 In the case where the Central Bank acts on its own behalf, T2S does not send any message flows to the
 5 Payment Bank.

6 The fact that the Intra-balance Movement is linked to another instruction does not avoid its cancellation.

7 References:

8 UDFS: Use Case “Send Cancellation Instruction of a Settlement restriction on cash balance” (Chapter 2.12)

9 GUI BFD: T2S.GUI.SESE.INX.0050

10 **3.15.3.3.1 Receive Status Advice (Cancellation Instruction)**

Reference ID	T2S.BPD.SETT.CIBM.02.01
--------------	-------------------------

11 The Central Bank and Payment Bank receive status advice messages for every change of status to the
 12 Cancellation Instruction in T2S. Additionally this activity receives the reason code update in case the
 13 Cancellation Instruction is denied.

14 If T2S has been instructed via the T2S GUI the status is shown on the screen.

15

1 The Central Bank and Payment Bank receive the following messages from T2S:

2 **Table 3-52: Messages from T2S [T2S.BPD.SETT.CIBM.02.01]**

Name	ISO Code	To/From T2S	Event	UDFS Chapter
IntraBalanceMovementCancellationRequestStatusAdvice	camt.078.001.01	From T2S	Change in status/reason code of the cancellation instruction	3.3.3.32

3 The message reports the statuses and relevant reason codes of a Cancellation Instruction.

4 Following the message reception, other internal activities might be conducted such as aligning the status of
 5 the Cancellation Instruction in the Central Bank’s or Payment Bank’s systems with the status in T2S. In case
 6 of rejection or denial an analysis can be launched before re-submitting a cancellation.

7 **3.15.3.3.2 Receive Status Advice (Intra-balance movement)**

Reference ID	T2S.BPD.SETT.CIBM.02.02
--------------	-------------------------

8 The Central Bank and Payment Bank receive status advice messages for every change of the cancellation
 9 status of the referenced Intra-balance Movement in T2S as well as any reason code update of its cancellation
 10 status.

11 The Central Bank and Central Bank Participant receive the following message from T2S:

12 **Table 3-53: Messages from T2S [T2S.BPD.SETT.CIBM.02.02]**

Name	ISO Code	To/From T2S	Event	UDFS Chapter
IntraBalanceMovementStatusAdvice	camt.067.001.01	From T2S	Change in status of the settlement restriction on cash balance (“cancelled”)	3.3.3.21

13 The message reports the statuses and relevant reason codes of an Intra-balance Movement.

14 Following the message reception, other internal activities might be conducted such as:

- 15 • aligning the status of the Intra-balance Movement in the Central Bank’s or Central Bank Participant’s
- 16 systems with the status in T2S,
- 17 • sending amendment instructions of instructions that were linked to the cancelled instruction to modify
- 18 the link indicators,
- 19 • triggering notification to third parties down the chain.

1 **3.16 AMENDMENT OF SETTLEMENT INSTRUCTION OR RESTRICTION**
2 **[T2S.BPD.SETT.AINS]**

3 **3.16.1 OVERVIEW**

4 This process describes the act of amending a settlement instruction or restriction in T2S. A CSD or Central
5 Bank or either one's participant may use this process, as a corrective action to a pending settlement
6 instruction or restriction, for instance when a previously sent instruction's processing indicator was not
7 correct or is not valid anymore. Only priority, linkage and partial settlement indicator of such an instruction
8 or restriction⁴³ are modifiable.

9 **Trigger:**

10 A CSD or Central Bank or either one's participant receives details for amending the settlement instruction or
11 settlement restriction

12 **Preconditions:**

13 The CSD or Central Bank or their participant knows the reference of the settlement instruction or settlement
14 restriction to be amended.

15 **T2S Instructing Party:**

16 There are four scenarios for the instruction of T2S:

- 17 • Scenario A: CSD instructs T2S.
18 • Scenario B: CSD Participant instructs T2S.
19 • Scenario C: Central Bank instructs T2S.
20 • Scenario D: Payment Bank instructs T2S.

⁴³ Partial settlement is not applicable and therefore not modifiable in settlement restrictions.

1 **3.16.2 BUSINESS PROCESS DIAGRAM**

2 **Figure 3-20: Business Process Diagram [T2S.BPD.SETT.AINS]**

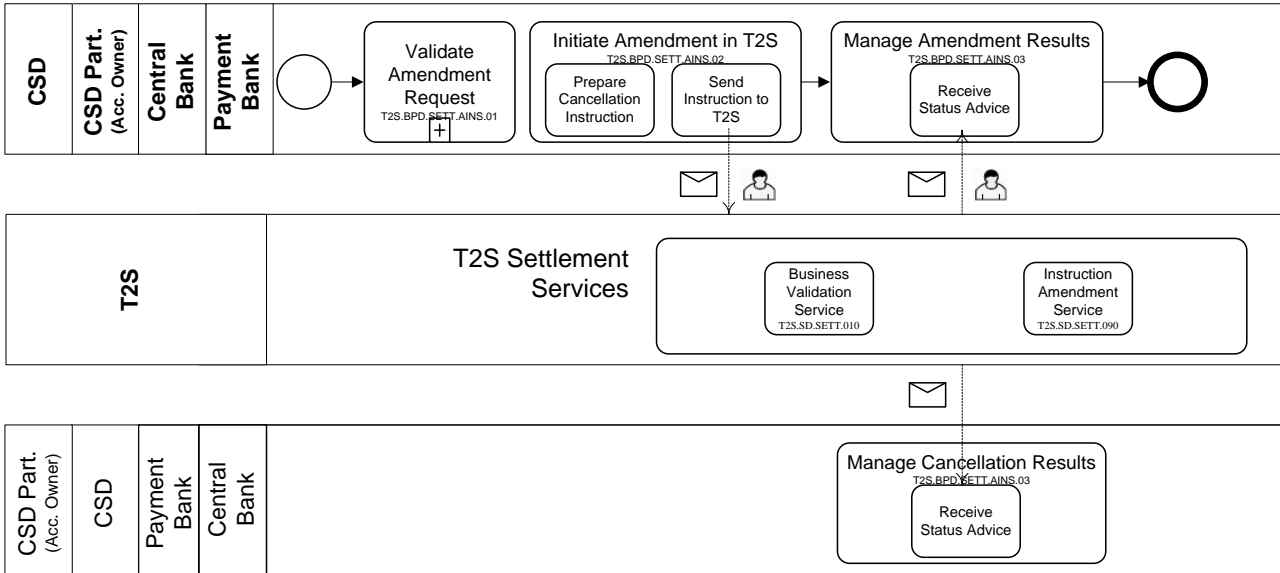

3

4 **3.16.3 BUSINESS PROCESS DESCRIPTION**

5 **3.16.3.1 VALIDATE AMENDMENT REQUEST**

Reference ID	T2S.BPD.SETT.AINS.01
---------------------	----------------------

6 T2S Actors: CSD (Scen. A)/CSD Participant (Scen. B)/ Central Bank (Scen. C)/ Payment Bank (Scen. D)

7 The CSD [CSD Participant/Central Bank/Payment Bank] checks⁴⁴ all the details in the amendment
 8 instruction against the reference data (maintained by the CSD/Central Bank or CSD Participant/Payment
 9 Bank if directly connected to T2S).

10 **3.16.3.2 INITIATE AMENDMENT IN T2S**

Reference ID	T2S.BPD.SETT.AINS.02
---------------------	----------------------

11 T2S Actors: CSD (Scen. A)/CSD Participant (Scen. B)/ Central Bank (Scen. C)/ Payment Bank (Scen. D)

12 The CSD [CSD Participant/Central Bank/Payment Bank] enriches the amendment instruction with details
 13 required for settlement processing in T2S and sends the amendment instruction to T2S.

14 References:

⁴⁴ For instance if the partial settlement indicator was set by a CSD or a CCP/Stock Exchange with power of attorney, it is not possible to be modified in T2S. Also “reserved” priority is allowed only for CSDs and Central Banks. “Top” priority only allowed to CCP and Stock Exchange instructions.

1 UDFS: Use Cases “Send Amendment Instruction of a Settlement Instruction or of a Settlement Restriction
 2 on Securities Position” (Chapter 2.8) and “Send Amendment Instruction of a Settlement Restriction on Cash
 3 Balance” (Chapter 2.9)

4 GUI BFD: T2S.GUI.SESE.INX.0040

5 **3.16.3.2.1 Enrich Amendment Instruction**

Reference ID	T2S.BPD.SETT.AINS.02.01
---------------------	-------------------------

6 The CSD [CSD Participant/Central Bank/Payment Bank] enriches the Amendment instruction with T2S
 7 specific information like reference of the instruction⁴⁵ to be modified, T2S securities or cash account number
 8 and the requested change. (unlink, link, partial settlement indicator and threshold type⁴⁶ or priority)

9 Only one change is allowed per maintenance instruction.

10 It is to be noted that should the amendment instruction use the reference of an already matched instruction,
 11 the process indicators of the two legs will be modified.

12 **3.16.3.2.2 Send Amendment Instruction to T2S**

Reference ID	T2S.BPD.SETT.AINS.02.02
---------------------	-------------------------

13 The CSD [CSD Participant/Central Bank/Payment Bank] converts the Amendment instruction enriched with
 14 T2S specific information and transmits it to T2S.

15 The instruction of T2S is also possible via the T2S GUI.

16

⁴⁵ Settlement instruction, settlement restriction on securities position or settlement restriction on cash balance

⁴⁶ Partial settlement indicator and threshold type is not a modifiable parameter for the settlement restriction on securities position and on cash balance.

1 The CSD [CSD Participant/Central Bank/Payment Bank] sends the following messages to T2S:

2 **Table 3-54: Messages to T2S [T2S.BPD.SETT.AINS.02.02]**

Name	ISO Code	From/To T2S	Event	UDFS Chapter
SecuritiesSettlementConditionModificationRequestV03	sese.030.001.03	To T2S	Need to Amend a settlement instruction or a settlement restriction on securities position	3.3.8.10
IntraBalanceMovementModificationRequest	camt.072.001.01	To T2S	Need to Amend a settlement restriction on cash balance	3.3.3.26

3 **3.16.3.3 T2S PROCESSING**

4 The **Business Validation Service (T2S.SD.SETT.010)** validates the received amendment instruction
 5 (SecuritiesSettlementConditionModificationRequest). After successful validation, the **Instruction**
 6 **Amendment Service (T2S.SD.SETT.090)** facilitates the amendment of process indicators in the settlement,
 7 intra-position movement or intra-balance movement instruction and sends the related status advices
 8 (SecuritiesSettlementConditionModificationStatusAdvice or
 9 IntraBalanceMovementModificationRequestStatusAdvice) to the relevant parties.

10 **3.16.3.4 MANAGE AMENDMENT RESULTS**

Reference ID	T2S.BPD.SETT.AINS.03
---------------------	----------------------

11 T2S Actors: CSD and CSD Participant (Scen. A and B)/Central Bank and Payment Bank (Scen. C and D)

12 The CSD and CSD Participant [Central Bank and Payment Bank] receive the settlement related messages
 13 from T2S and initiates related internal processes.

14 References:

15 UDFS: Use Cases “Send Amendment Instruction of a Settlement Instruction or 1 of a Settlement Restriction
 16 on Securities Position” (Chapter 2.8) and “Send Amendment Instruction of a Settlement Restriction on Cash
 17 Balance”(Chapter 2.9)

18 GUI BFD: T2S.GUI.SESE.INX.0010, T2S.GUI.SESE.INX.0020, T2S.GUI.SESE.INX.0030

19

1 **3.16.3.4.1 Receive Status Advice**

Reference ID	T2S.BPD.SETT.AINS.03.01
---------------------	-------------------------

2 The CSD and CSD Participant [Central Bank and Payment Bank] can receive status advices notifying of:

- 3 • rejection of the Amendment instruction,
 4 • acceptance of the Amendment instruction,
 5 • denial of the Amendment instruction,
 6 • execution of the Amendment instruction.

7 If T2S has been instructed via the T2S GUI the status is shown on the screen.

8 Following the message reception, other internal activities might be conducted such as:

- 9 • aligning the status of the Amendment instruction in the CSD and CSD Participant [Central Bank and
 10 Payment Bank]’s systems with the status in T2S,
 11 • triggering notification to CSD Participants [Payment Bank] in case the CSD [Central Bank] instructed on
 12 their behalf,
 13 • performing analysis after a failed amendment instruction.

14 The CSD and CSD Participant [Central Bank and Payment Bank] receive the following messages from T2S:

15 **Table 3-55: Messages to T2S [T2S.BPD.SETT.AINS.03.01]**

Name	ISO Code	From/To T2S	Event	UDFS Chapter
SecuritiesSettlement ConditionModificati onStatusAdviceV03	sese.031.001.03	From T2S	Positive or failed business validation, Maintenance instruction not eligible, Maintenance instruction executed	3.3.8.11
IntraBalanceMovem entModificationReq uestStatusAdvice	camt.073.001.01	From T2S	Positive or failed business validation, Maintenance instruction not eligible, Maintenance instruction executed	3.3.3.26

16

1 **3.17 ACCOUNT ALLOCATION [T2S.BPD.SETT.AALO]**

2 This process describes the act of conducting an account allocation in T2S. In a pure direct holding country⁴⁷,
3 the account allocation happens in an end-investor securities account. The account allocation is a movement
4 between a CSD Participant's securities account and an end-investor's securities account in the books of a
5 custodian or a CSD (as account servicer or account operator). This process includes movements between
6 end-investor accounts within the same CSD and movements due to corporate action entitlements. Such
7 movements can be realised via a FOP and/or a DVP instruction.

8 T2S has a specific pricing for account allocation instructions, as this is a specificity of direct holding
9 markets. Such instructions will be identified based on an "End Investor Account" flag on the securities
10 account of the end-investor in T2S. Based on this flag specified for the involved securities accounts,
11 instructions will be counted separately

12 Instructions affecting such "flagged" accounts will follow the core settlement processes.

13 For details on the instruction of T2S and messages received, refer to process "Intra-CSD Settlement
14 [T2S.BPD.SETT.ICSD]".

15

⁴⁷ In a pure direct holding country, such as Finland, all citizens' and enterprises' accounts holding balance at the end of the day are direct holding accounts, irrespective whether they are retail customers' or e.g. banks' accounts. Nominee accounts are allowed only for foreigners and, in the Finnish case, the balance of commission accounts must be, by law, zero at the end of the day. Furthermore, as of current practise, all accounts have a specific identifier for the account type in the local CSD-system. This makes it very easy to identify account allocations as in practise all FOPs booked on national entities' accounts are account allocations, and the account identifier provides for efficient matching of transactions according to the account type.

1 **3.18 PLEDGING OF SECURITIES [T2S.BPD.SETT.PLED]**

2 This process describes the act of conducting pledges in T2S. Pledging of securities is a procedure by which
3 institutions pledge securities in order to conform to legal or regulatory requirements or to raise liquidity. E.g.
4 The CSD Participant taking credit (pledgor) pledges securities (collateral) to the CSD Participant who is
5 providing credit (pledgee) as a guarantee to obtain liquidity.

6 The CSD or CSD Participants can pledge securities using three different methods.

- 7 • Transfer securities from pledgor's securities account to a pledgee's security account: this procedure
8 follows the core settlement process flow in intra-CSD as well as cross-CSD and external CSD settlement
9 scenarios i.e. the CSD or CSD Participant uses a standard Free of payment or delivery versus payment
10 settlement instruction to initiate the transfer of securities specifying the pledgee's account as receiving
11 account. For details on the process flow and messages involved, refer to section "Core Settlement
12 Processes".
- 13 • Pledge one of pledgor's accounts to pledgee i.e. transfer securities from one of the pledgor's securities
14 accounts to another account (of the pledgor) pledged to the pledgee: this procedure follows the core
15 settlement process flow of the intra-CSD settlement scenario i.e. the CSD or CSD Participant uses a
16 standard Free of payment or versus payment settlement instruction to initiate the transfer of securities
17 specifying the pledged account as receiving account. For details on the process flow and messages
18 involved, refer to section "Core Settlement Processes".
- 19 • Pledge a specific balance within pledgor's securities account i.e. transfer securities to this specific
20 balance: this procedure uses the intra-position movement functionality and follows the process flow
21 specified in the Earmarking of Securities process i.e. the CSD or CSD Participant uses the Intra-Position
22 Movement Instruction to initiate the transfer of securities to the pledged balance within its own account.
23 For details on the earmarking of a securities position, refer to process "Earmarking of Securities Position
24 [T2S.BPD.SETT.EARM]".

1 4. ASSET SERVICES PROCESSES

2 4.1 REPURCHASE AGREEMENTS [T2S.BPD.SETT.REPO]

3 4.1.1 OVERVIEW

4 This process describes the act of initiating a Repurchase Agreement. A Repurchase Agreement, also known
5 as a “Repo”, is the sale of securities together with an agreement for the “seller⁴⁸” to buy back its securities
6 used as collateral, at a later date from the “buyer⁴⁹” on a secured cash loan at a fixed or variable rate of
7 interest. The price at maturity will be greater than the original sale price, the difference effectively
8 representing interest, sometimes called the “repo rate”.

9 A Repo is equivalent to a cash transaction combined with a forward contract. Such a repo usually has the
10 following features:

- 11 • the “cash transaction” results in transfer of cash as the “original sale price” to the borrower in exchange
12 for legal transfer of the collateral securities to the lender during “Opening of a Repo”,
- 13 • the “forward contract” ensures repayment of the cash as the “price at maturity” to the lender and return
14 of the collateral of the borrower during “Closing of a Repo”.

15 The difference between the “original sale price” and the “price at maturity of a repo” is effectively the
16 interest on the repo while the settlement date of the forward contract is the maturity date (i.e. closing date) of
17 the repo.

18 Any securities (e.g. corporate and Treasury/Government bonds, and stocks) may be used as "collateral" in a
19 repo transaction, as agreed between the seller and the buyer and allowed in the market.

20 T2S facilitates settlement of such repo transactions instructed by cash taker and cash provider (or another
21 party on their behalf), at any time during a settlement day. Here, the cash taker and the cash provider are
22 CSDs or CSD Participants with one party initiating the repo transaction with its counterpart. Additionally, a
23 stock exchange can also facilitate the matching of such repo trades, between the cash taker and cash provider
24 and instruct a pre-matched settlement instruction to T2S.

25 In the event of a Repo, the legal title to the collateral securities passes from the seller to the buyer. Any
26 interest payable (e.g. out of corporate actions) on the collateralised securities is usually passed directly onto
27 the repo seller.

⁴⁸ The “seller” is also referred as “borrower” or “cash taker”

⁴⁹ The “buyer” is also referred as “lender” or “cash provider”

1 The Repo agreement might instead provide that the buyer receives such interest payable (e.g. coupon), with
2 the cash payable on repurchase being adjusted to compensate. T2S facilitates settlement of such
3 “compensation” effects at any time during a settlement day for all participating CSDs and its participants, as
4 part of settlement of the repo.

5 Alternatively, T2S also facilitates settlement of such “compensation” effects as settlement of “market
6 claims”. For details refer to 5.3.1 [Market Claims \[T2S.BPD.SETT.MCLA\]](#)~~Market—Claims~~
7 ~~[T2S.BPD.SETT.MCLA]~~.

8 Additionally, during the term of a repo, a need to manage risk exposure between the seller and the buyer can
9 arise due to fluctuations in worth of the collateral with the buyer, leading to margin movements and
10 substitutions of securities and/or cash. T2S also facilitates settlement of such “risk management” effects
11 following the standard settlement processes.

12 **Trigger:**

13 The CSD or another authorised party receives “opening of a repo” or “closing of a repo” trades with the
14 necessary details.

15 Maturity of repo triggers the “closing of a repo” related settlement processes

16 **Preconditions:**

17 None

18 **T2S Instructing Party:**

19 There are two scenarios for the instruction of T2S.

20 Scenario A: CSD instructs T2S.

21 Scenario B: CSD Participant instructs T2S.

22 This process is a variation of the core settlement processes. Even though it applied to all three types of
23 settlement (intra-CSD, cross-CSD, external-CSD), the diagram below refers to the intra-CSD settlement
24 Process for the purpose of illustration.

25 Only deviations from the base process are described.

1 4.1.2 BUSINESS PROCESS DIAGRAM

2 **Figure 4-1: Business Process Diagram [T2S.BPD.SETT.REPO]**

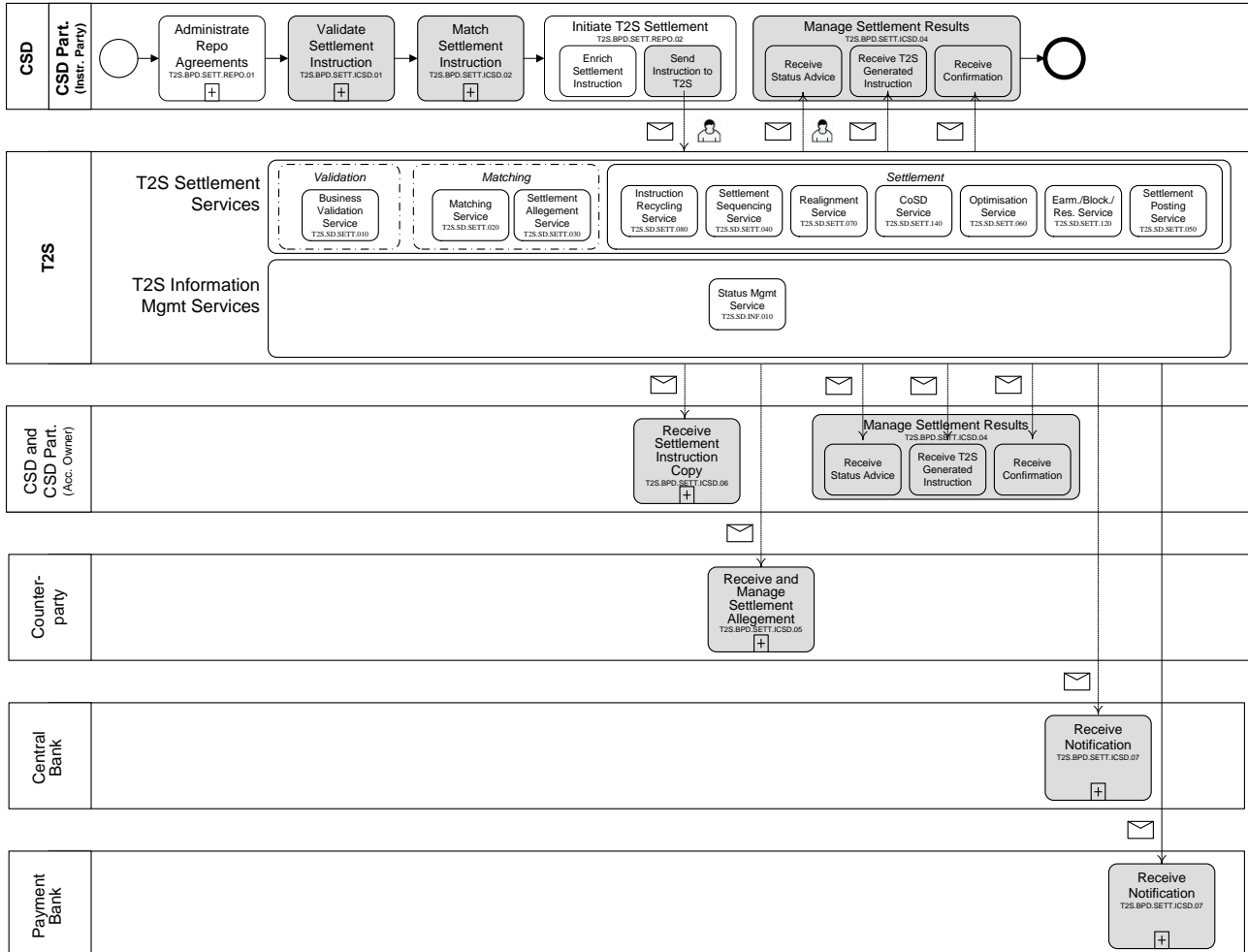

3 4.1.3 BUSINESS PROCESS DESCRIPTION

4 This Business Process Description is applicable to Scenario A and B unless otherwise noted. For the purpose
 5 of readability, the actor names in the text refer to Scenario A with the Scenario B actor indicated in square
 6 brackets.
 7 brackets.

8 4.1.3.1 ADMINISTRATE REPO AGREEMENTS

Reference ID	T2S.BPD.SETT.REPO.01
--------------	----------------------

9 T2S Actors: CSD Participant

10 The CSD Participant as the cash taker/cash provider identifies its need for cash/its need to lend cash to
 11 prospective cash takers respectively. It enters into a repo agreement with its counterpart with the related
 12 terms and conditions of the opening/closing of a repo, the type of collaterals accepted and mutually agreeable
 13 interest rate charges with or without compensation needs.

1 The CSD, a Central Bank or Stock Exchange can maintain these repo agreements to facilitate repo
 2 transaction settlement.

3 **4.1.3.2 INITIATE T2S SETTLEMENT**

Reference ID	T2S.BPD.SETT.REPO.02
--------------	----------------------

4 T2S Actors: CSD (Scenario A)/CSD Participant (Scenario B)

5 The CSD [CSD Participant] enriches the repo related settlement instruction with details required for
 6 settlement processing in T2S and sends the settlement instruction to T2S for “Opening of a Repo” and for
 7 “Closing of a Repo”.

8 The CSD [CSD Participant] prepares its relevant repo details such as collateral securities with its quantity,
 9 cash amount, intended settlement date, counterparty details, etc. The CSD [CSD Participant] prepares
 10 settlement instructions and instructs T2S.

11 There are different possibilities to instruct T2S for the “opening of a repo” and “closing of a repo”. The CSD
 12 [CSD Participant] can send its settlement instructions for the closing leg(s) of a repo at the same or at a
 13 different time than the opening leg(s).

14 References:

15 UDFS: Use Case “Send Settlement Instruction” (Chapter 2.3)

16 GUI BFD: T2S.GUI.SESE.INX.0070

17 **4.1.3.2.1 Enrich Settlement Instruction**

Reference ID	T2S.BPD.SETT.REPO.02.01
--------------	-------------------------

18 The CSD [CSD Participant] prepares the Settlement Instruction for the opening of a repo/closing of a repo
 19 related settlement instructions with the needed links as detailed below.

20 The CSD [CSD Participant] has different possibilities to instruct “opening of a repo” and “closing of a repo”
 21 related instructions.

- 22 • individual instructions of “opening leg(s) of a repo” or “closing leg(s) of a repo” without any linkage
 23 information,
- 24 • linking together (all) “opening leg(s) of a repo” or (all) “closing leg(s) of a repo”,
 - 25 ○ settlement on an “All-or-none” basis for one or more instructions with a linked “WITH” processing
 26 code,
 - 27 ○ settlement of one or more instructions with the usage of a “pool reference”.

- 1 • linking together “opening leg(s) of a repo” and “closing leg(s) of a repo”,
 - 2 ○ one or more of the “closing leg(s) of a repo” instructions can specify an “AFTE” link to the related
 - 3 “opening leg of a repo”,
 - 4 ○ one or more of the “opening leg of a repo” instruction can specify a “BEFO” link to the related
 - 5 “closing leg of a repo” leg,
 - 6 ○ additionally, a “common repo reference” can specify in each of the “opening leg of a repo” and
 - 7 “closing leg of a repo” settlement instructions for the instructing parties to identify the repo as a
 - 8 single transaction. However T2S will not use the “common repo reference” in the validation and
 - 9 subsequent processing of such repo instructions.

10 The CSD [CSD Participant] can instruct T2S using use the below types of settlement instructions and
 11 transaction types.

- 12 • one or more Deliver Against Payment instructions,
- 13 • a single Payment Free of delivery instruction and one or more Free of Payment instructions,
- 14 • one or more Deliver Against Payment and one or more Free of Payment.

15 **Table 4-1: Repo Transaction Types [T2S.BPD.SETT.REPO.02.01]**

Securities transaction type	ISO definition
REPU	Relates to a repurchase agreement transaction
RVPO	Relates to a reverse repurchase agreement transaction
TRPO	Relates to a triparty repurchase agreement
TRVO	Relates to a triparty reverse repurchase agreement

16

1 The instruction details used for the purpose of Repos are as below.

2 **Table 4-2: Repo Instruction Details [T2S.BPD.SETT.REPO.02.01]**

Instruction details for	From Cash provider		From Cash Taker		ISIN*	Settlement Quantity	Settlement Cash Amount
	Securities movement	Payment code	Securities movement	Payment code			
Opening of a repo	RECE	APMT	DELI	APMT	1 Collateral ISIN	Collateralised quantity	Original sale price
	RECE	APMT	DELI	APMT	1 Collateral ISIN	Zero	Original sale price
	RECE	FREE	DELI	FREE	Other collateral ISINs	Collateralised quantity	Zero
Closing of a repo	DELI	APMT	RECE	APMT	1 Collateral ISIN	Collateralised quantity	Cash amount (with interest)
	DELI	APMT	RECE	APMT	1 Collateral ISIN	Zero	Cash amount (with interest)
	DELI	FREE	RECE	FREE	Other collateral ISINs	Collateralised quantity	Zero

* For each additional collateral ISIN used for a repo, a Receive Free of Payment (from cash provider) and a Deliver Free of Payment (from cash taker) to T2S is required. Alternatively, the instructing parties can decide to split the cash amount involved across the different repo related instructions and avoid the “Free of payment” instructions to T2S.

3 **4.1.3.3 T2S PROCESSING**

4 For details on the T2S services involved, refer to process “Intra-CSD Settlement [T2S.BPD.SETT.ICSD]”.

1 4.2 ISSUANCE OF SECURITIES [T2S.BPD.SETT.ISSU]

2 4.2.1 OVERVIEW

3 This process describes the act of issuing a new security in the context of T2S. Issuance of securities is a
4 procedure wherein the issuer (i.e. governments, corporations or investment funds) sells securities to the
5 public for the first time, for which there does not yet exist a secondary market⁵⁰. This requires the issuer to
6 market and distribute the securities, as well as determine the appropriate issuance price.

7 A typical issuance process consists of activities which may include a number of actors: issuers, issuer's
8 agents (investment banks acting as underwriters, dealers, transfer agents etc) registrars, national numbering
9 agencies, custodians, etc. This process description focuses on the interaction between the CSD and T2S
10 during the issuance activity.

11 **Trigger:**

12 The CSD receives reference data for new securities: This business process starts with the CSD receiving new
13 securities details from the issuer/issuer agent and a request for creation of issuance and distribution securities
14 accounts. The CSD receives the issuance information from the issuer/issuer's agent to book the securities in
15 the respective issuance and distribution accounts.

16 **Preconditions:**

17 None

18 **T2S Instructing Party:**

19 CSD

⁵⁰ Secondary market is the financial market where previously issued securities are bought and sold.

1 **4.2.2 BUSINESS PROCESS DIAGRAM**

2 **Figure 4-2: Business Process Diagram [T2S.BPD.SETT.ISSU]**

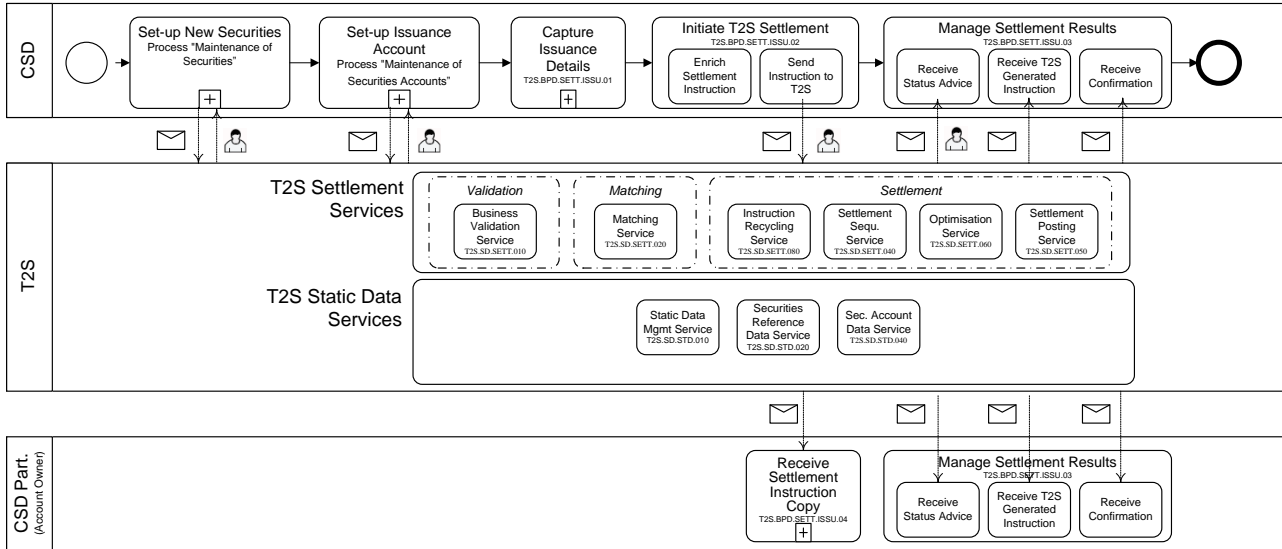

3

4 **4.2.3 BUSINESS PROCESS DESCRIPTION**

5 **4.2.3.1 MAINTENANCE OF SECURITIES**

6 This process involves the receipt of securities reference data for the set-up of new securities in the CSD
 7 systems and T2S. The set-up of securities reference data and issuance accounts is a precondition for CSDs to
 8 process issuance information regarding the initial owners of the securities.

9 For details on the creation of a security, refer to process “Maintenance of Securities
 10 [T2S.BPD.STDA.MSEC]”.

11 **4.2.3.2 MAINTENANCE OF SECURITIES ACCOUNT**

12 This process involves the receipt of issuance account details for the set-up of a new issuance securities
 13 account in the CSD systems and T2S. The issuance account in T2S must have the capability to store negative
 14 values for securities positions.

15 Some issuers/issuer’s agents may also require the set-up of an additional securities account for parking the
 16 issued securities until final distribution orders are available for crediting the securities accounts of initial
 17 owners.

18 This process is an optional step because an issuer/issuer’s agent that already holds an issuance securities
 19 account with the CSD (and in T2S), will most likely use the same issuance securities account for all the
 20 securities it issues unless it needs to segregate the different ISINs for tax, regulatory or operational purposes.

1 For details on the creation of a securities account, refer to process “Maintenance of Securities Account
2 [T2S.BPD.STDA.MSAC]”.

3 **4.2.3.3 CAPTURE ISSUANCE DETAILS**

Reference ID	T2S.BPD.SETT.ISSU.01
--------------	----------------------

4 T2S Actors: CSD

5 The CSD receives the issuance information from the issuer/issuer’s agent (i.e. CSD Participant) and validates
6 it.

7 The issuance information contains details such as the securities account of the initial owners, the quantity of
8 securities issued to each initial owner, etc. The CSD validates the issuance information against its securities
9 and securities account reference data.

10 **4.2.3.4 INITIATE T2S SETTLEMENT**

Reference ID	T2S.BPD.SETT.ISSU.02
--------------	----------------------

11 T2S Actors: CSD

12 The CSD enriches the settlement instruction (i.e. instructions for issuance of new securities to initial owners)
13 with details required for settlement processing in T2S and sends the settlement instruction to T2S.

14 References:

15 UDFS: Use Case “Send Settlement Instruction” (Chapter 2.3)

16 GUI BFD⁵¹: T2S.GUI.SESE.INX.0070

17 **4.2.3.4.1 Enrich Settlement Instruction**

Reference ID	T2S.BPD.SETT.ISSU.02.01
--------------	-------------------------

18 The CSD enriches the settlement instructions with T2S specific information such as T2S securities account
19 numbers corresponding to the issuance and participant account numbers in the CSD and delivery and receipt
20 securities position types. While in some markets, the respective CSD may send an already matched
21 instruction for delivering securities from issuance account to CSD Participant account, there are other
22 markets wherein the CSD Participant has to send a matching settlement instruction.

⁵¹ Use of U2A channel for sending settlement instructions for issuance of securities is very unlikely considering the volume of settlement instructions.

1 Based on the set-up of securities accounts by the issuer/issuer’s agent for issuance of securities the CSD
 2 sends

- 3 • In case of both issuance and distribution accounts: a settlement instruction to debit the issuance account
 4 and credit the distribution account (issuance step) followed by one or more settlement instructions to
 5 debit the distribution account and credit the initial holders’ securities accounts (distribution step).
 6 Settlement instructions in the distribution step may be instructed to settle individually or on an “All-or-
 7 none” basis; or
- 8 • In case of only issuance accounts: settlement instructions to debit the issuance account and directly credit
 9 the initial holders’ securities accounts.

10 **4.2.3.4.2 Send Settlement Instruction to T2S**

Reference ID	T2S.BPD.SETT.ISSU.02.02
--------------	-------------------------

11 The CSD converts the settlement instruction enriched with T2S specific information and T2S process
 12 indicators into the required message format and transmit it to T2S.

13 The CSD sends the following message to T2S:

14 **Table 4-3: Messages to T2S [T2S.BPD.SETT.ISSU.02.02]**

Message Name	ISO Code	To/From T2S	UDFS Chapter
SecuritiesSettlementTran sactionInstructionV03	Sese.023.001.03	To T2S	3.3.8.4

15 The processing of settlement instruction in T2S depends on the specified values of the T2S process
 16 indicators in the settlement instruction.

17 **4.2.3.5 T2S PROCESSING**

18 For details on the T2S services involved in the creation of a security, refer to process “Maintenance of
 19 Securities [T2S.BPD.STDA.MSEC]”.

20 For details on the T2S services involved in the creation of a securities account, refer to process “Maintenance
 21 of Securities Account [T2S.BPD.STDA.MSAC]”.

22 For details on the T2S services involved in the settlement of the instructions for issuance of new securities to
 23 initial owners), refer to process “Intra-CSD Settlement [T2S.BPD.SETT.ICSD]”.

24 In addition, the Issuance Account and ISIN link check validates if the securities account included in a
 25 settlement instruction is an issuance account, T2S validates that either the relevant securities CSD link has no

1 issuance account attached, or that the issuance account included in the settlement instruction is one of the
 2 issuance accounts attached to the Security CSD link.

3 **4.2.3.6 MANAGE SETTLEMENT RESULTS**

Reference ID	T2S.BPD.SETT.ISSU.03
--------------	----------------------

4 T2S Actors: CSD and CSD Participants

5 The CSD receives the settlement related messages from T2S and initiates related internal processes.

6 References:

7 UDFS: Use Case “Send Settlement Instruction” (Chapter 2.3)

8 **4.2.3.6.1 Receive Status Advice**

Reference ID	T2S.BPD.SETT.ISSU.03.01
--------------	-------------------------

9 The CSD receives status advice messages for every change of status or update of reason code to the
 10 settlement instruction within T2S.

11 Following the message reception, other internal activities might be conducted such as:

- 12 • aligning the status of the settlement instruction in the CSD or CSD Participant’s systems with the status
 13 in T2S,
- 14 • amending the settlement instruction,
- 15 • sending additional settlement instructions,
- 16 • triggering notification to CSD Participants.

17 The CSD receives the following message from T2S:

18 **Table 4-4: Messages from T2S [T2S.BPD.SETT.ISSU.03.01]**

Message Name	ISO Code	To/From T2S	Event	UDFS Chapter
SecuritiesSettlementTransactionStatusAdviceV03	Sese.024.001.03	From T2S	Change in status of settlement instruction	3.3.8.5

19 **4.2.3.6.2 Receive T2S Generated Instructions**

Reference ID	T2S.BPD.SETT.ISSU.03.02
--------------	-------------------------

1 The CSD receives the messages for T2S generated instructions. For settlement instructions pertaining to
 2 issuance of securities, T2S may generate additional instructions due to auto-collateralisation or the use of
 3 restricted resources (e.g. blocked or reserved cash balances) only.

4 The CSD receives the following message from T2S:

5 **Table 4-5: Messages from T2S [T2S.BPD.SETT.ISSU.03.02]**

Message Name	ISO Code	To/From T2S	Event	UDFS Chapter
SecuritiesSettlementTransactionGenerationNotificationV03	Sese.032.001.03	From T2S	Generation of settlement instructions by T2S due to auto-collateralisation and use of restricted resources.	3.3.8.12

6 **4.2.3.6.3 Receive Confirmations**

Reference ID	T2S.BPD.SETT.ISSU.03.03
--------------	-------------------------

7 The CSD receives and validates settlement confirmation messages for the settlement instructions sent to T2S
 8 and the T2S generated settlement instructions.

9 Following the message reception, other internal activities might be conducted such as:

- 10 • aligning the status of the settlement instruction in the CSD or CSD Participant’s books with the status in
 11 T2S,
- 12 • sending additional settlement instructions,
- 13 • triggering notification to CSD Participants to inform the availability of securities in their accounts
- 14 • performing the registration of securities (in case the registrar is involved after the CSD has started
 15 maintaining accounts of ownership),
- 16 • informing the issuer/issuer’s agent so that they apply for listing of securities in exchange.

17 The CSD receives the following message from T2S:

18 **Table 4-6: Messages from T2S [T2S.BPD.SETT.ISSU.03.03]**

Message Name	ISO Code	To/From T2S	Event	UDFS Chapter
SecuritiesSettlementTransactionConfirmationV03	Sese.025.001.03	From T2S	Partial or Full settlement of the settlement instruction	3.3.8.6

1 **4.2.3.7 RECEIVE SETTLEMENT INSTRUCTION COPY**

Reference ID	T2S.BPD.SETT.ISSU.04
--------------	----------------------

2 T2S Actors: CSD Participant

3 The CSD Participant receives the copy of settlement instruction initiated by the CSD on securities account
4 owned by the CSD Participant.

5 The CSD Participant stores the CSD initiated settlement instruction (copy) and references the same upon
6 receipt of status updates and confirmations from T2S.

7

1 **4.3 SECURITIES LENDING AND BORROWING [T2S.BPD.SETT.LEND]**

2 **4.3.1 OVERVIEW**

3 This process describes the act of conducting securities lending and borrowing in T2S. Securities lending
4 refers to the lending of securities by one party (lender) to another (borrower) usually against collateral
5 provided by the borrower. The collateral may be cash or securities. After expiry of the securities lending
6 agreement, the borrower needs to return the borrowed securities to the lender and the collateral needs to be
7 returned to the borrower.

8 This process is a variation of the core settlement process and applies to intra-CSD as well as cross-CSD and
9 external CSD settlement scenarios. For reason of clarity the diagram and description below refer to the intra-
10 CSD settlement only. For details refer to section “Core Settlement Processes”.

11 **Trigger:**

12 The CSD or CSD Participant identifies the need for borrowing securities.

13 **Preconditions:**

14 None

15 **T2S Instructing Party:**

16 There are two scenarios for the instruction of T2S:

- 17 • Scenario A: CSD instructs T2S.
18 • Scenario B: CSD Participant instructs T2S.

1 **4.3.2 BUSINESS PROCESS DIAGRAM**

2 **Figure 4-3: Business Process Diagram [T2S.BPD.SETT.LEND]**

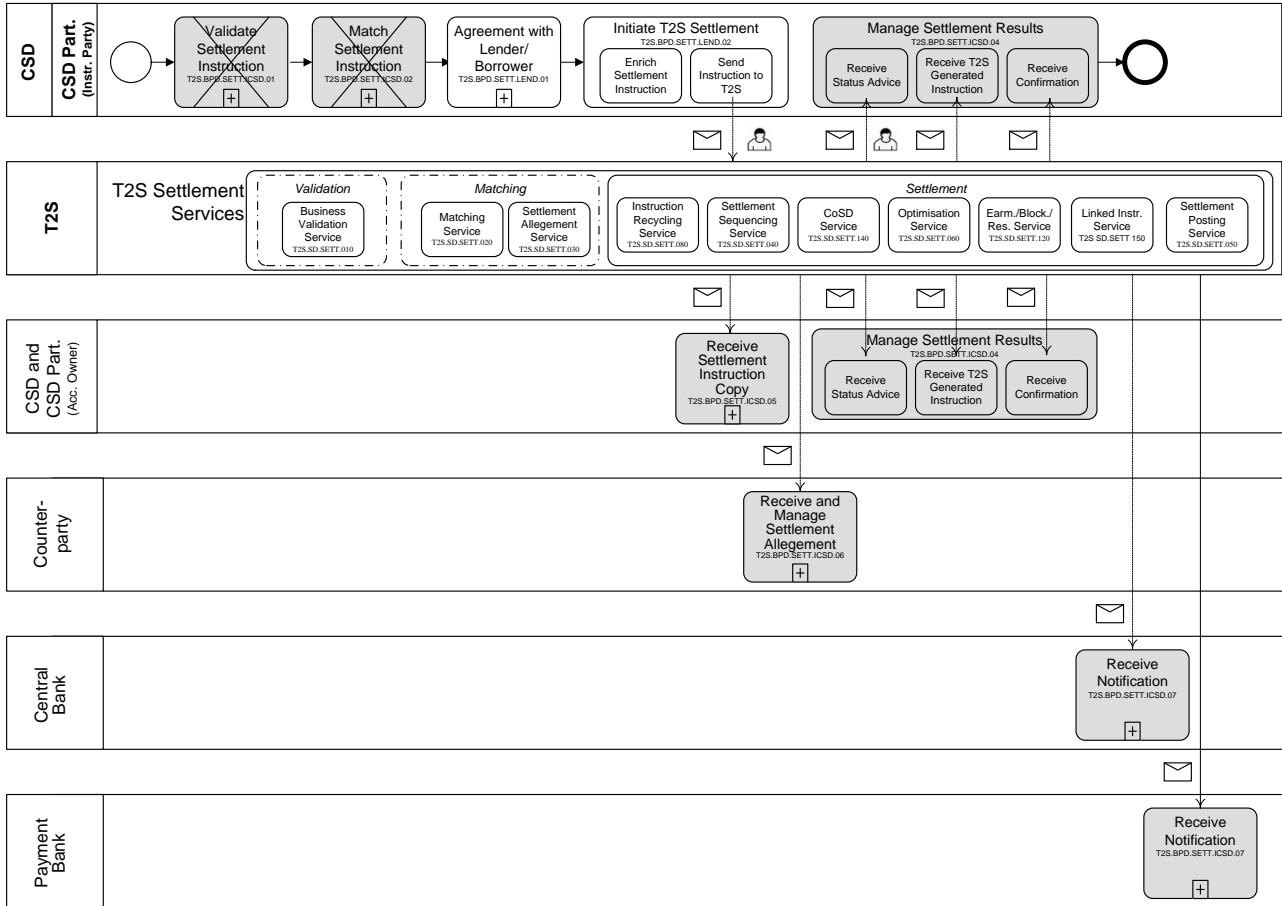

3

4 **4.3.3 BUSINESS PROCESS DESCRIPTION**

5 This Business Process Description is applicable to Scenario A and B unless otherwise noted. For the purpose
 6 of readability, the actor names in the text refer to Scenario A with the Scenario B actor indicated in square
 7 brackets.

8 **4.3.3.1 AGREEMENT WITH LENDER/BORROWER**

Reference ID	T2S.BPD.SETT.LEND.01
--------------	----------------------

9 T2S Actors: CSD (Scenario A)/CSD Participant (Scenario B)

10 The CSD [CSD Participant] identifies the need for borrowing securities. The CSD [CSD Participant]
 11 subsequently identifies a lender/borrower, and enters into an agreement for lending/borrowing of the
 12 securities.

1 **4.3.3.2 INITIATE T2S SETTLEMENT**

Reference ID	T2S.BPD.SETT.LEND.02
--------------	----------------------

2 T2S Actors: CSD (Scenario A)/CSD Participant (Scenario B)

3 The CSD [CSD Participant] creates settlement instructions for exchanging the securities positions (from
4 lender to borrower) and the collateral (from borrower to lender). The CSD [CSD Participant] enriches the
5 settlement instruction with details required for settlement processing in T2S and sends the settlement
6 instruction to T2S.

7 References:

8 UDFS: Use Case “Send Settlement Instruction” (Chapter 2.3)

9 GUI BFD: T2S.GUI.SESE.INX.0070

10 **4.3.3.2.1 Enrich Settlement Instruction**

Reference ID	T2S.BPD.SETT.LEND.02.01
--------------	-------------------------

11 The CSD [CSD Participant] enriches the settlement instruction.

12 The instruction types depending on the type of collateral are as below.

13 **Table 4-7: Instruction Types for Securities Lending [T2S.BPD.SETT.LEND.02.01]**

Instruction Details					
Collateral	Lender	Borrower	ISIN	Quantity	Amount
Cash	DVP	RVP	Lent/borrowed ISIN	Lent/borrowed quantity	Collateral amount
Securities	DFP	RFP	Lent/borrowed ISIN	Lent/borrowed quantity	None
	RFP	DFP	Collateral ISIN	Collateral quantity	None
Cash and securities	DVP	RVP	Lent/borrowed ISIN	Lent/borrowed quantity	Collateral amount
	RFP	DFP	Collateral ISIN	Collateral quantity	None

* For each additional collateral ISIN an RFP (from lender) and a DFP (from borrower) to T2S is required

14 The CSD [CSD Participant] can use below transaction types in the settlement instructions to T2S.

1 **Table 4-8: Securities transaction types for securities lending [T2S.BPD.SETT.LEND.02.01]**

Securities transaction type	ISO definition
COLI	CollateralIn, Relates to a collateral transaction, from the point of view of the collateral taker or its agent.
COLO	CollateralOut, Relates to a collateral transaction, from the point of view of the collateral giver or its agent
SECB	SecuritiesBorrowing, Relates to a securities borrowing operation.
SECL	SecuritiesLending, Relates to a securities lending operation.

2 The CSD [CSD Participant] could link all instructions related to a specific lending and borrowing transaction
 3 to settle on an “All or None” basis either

- 4 • by specifying a WITH link between them,
 5 • by specifying the same pool reference in all instructions.

6 The CSD [CSD Participant] may also send already matched instructions to T2S, provided it is authorised to
 7 send instructions on both delivering and receiving securities/cash accounts.

8 After the expiry of the lending contract, the lender sends instructions to T2S for delivering collateral cash
 9 and/or securities back to the borrower. The borrower sends instructions to T2S for delivering borrowed
 10 securities back to the lender. This process follows the same process steps as in ”Initiate T2S settlement”,
 11 except that the reciprocal attributes need to be used in the settlement instructions.

12 **4.3.3.2.2 Send Settlement Instruction to T2S**

Reference ID	T2S.BPD.SETT.LEND.02.02
--------------	-------------------------

13 The CSD [CSD Participant] converts the settlement instructions enriched with T2S specific information and
 14 T2S process indicators into the required message format and transmits them to T2S.

15 The instruction of T2S is also possible via the T2S GUI.

16

1 The CSD [CSD Participant] sends the following message to T2S:

2 **Table 4-9: Messages to T2S [T2S.BPD.SETT.LEND.02.02]**

Message Name	ISO Code	To/From T2S	UDFS Chapter
SecuritiesSettlementTransactionInstructionV03	Sese.023.001.03	To T2S	3.3.8.4

3 **4.3.3.3 T2S PROCESSING**

4 For details on the T2S services involved, refer to process “Intra-CSD Settlement [T2S.BPD.SETT.ICSD]”.

5

1 **4.4 BACK-TO-BACK TRADES [T2S.BPD.SETT.BTOB]**

2 **4.4.1 OVERVIEW**

3 This process describes the act of settling back-to-back trades in T2S. Back-to-back trades refer to a pair of
4 transactions that requires a T2S actor to receive and redeliver the same securities on the same day. The T2S
5 actor can send the settlement instructions to T2S, with the condition to settle the redelivery, after the receipt
6 of the securities. This type of trade can, for example, be used by brokers for the onward delivery to their
7 clients.

8 This process is a variation of the core settlement process and applies to intra-CSD as well as cross-CSD and
9 external CSD settlement scenarios. For reason of clarity the diagram and description below refer to the intra-
10 CSD settlement only. For details refer to section “Core Settlement Processes”.

11 **Trigger:**

12 The CSD or CSD Participant receives a back-to-back trade.

13 **Preconditions:**

14 None

15 **T2S Instructing Party:**

16 There are two scenarios for the instruction of T2S:

- 17 • Scenario A: CSD instructs T2S.
- 18 • Scenario B: CSD Participant instructs T2S.

1 **4.4.2 BUSINESS PROCESS DIAGRAM**

2 **Figure 4-4: Business Process Diagram [T2S.BPD.SETT.BTOB]**

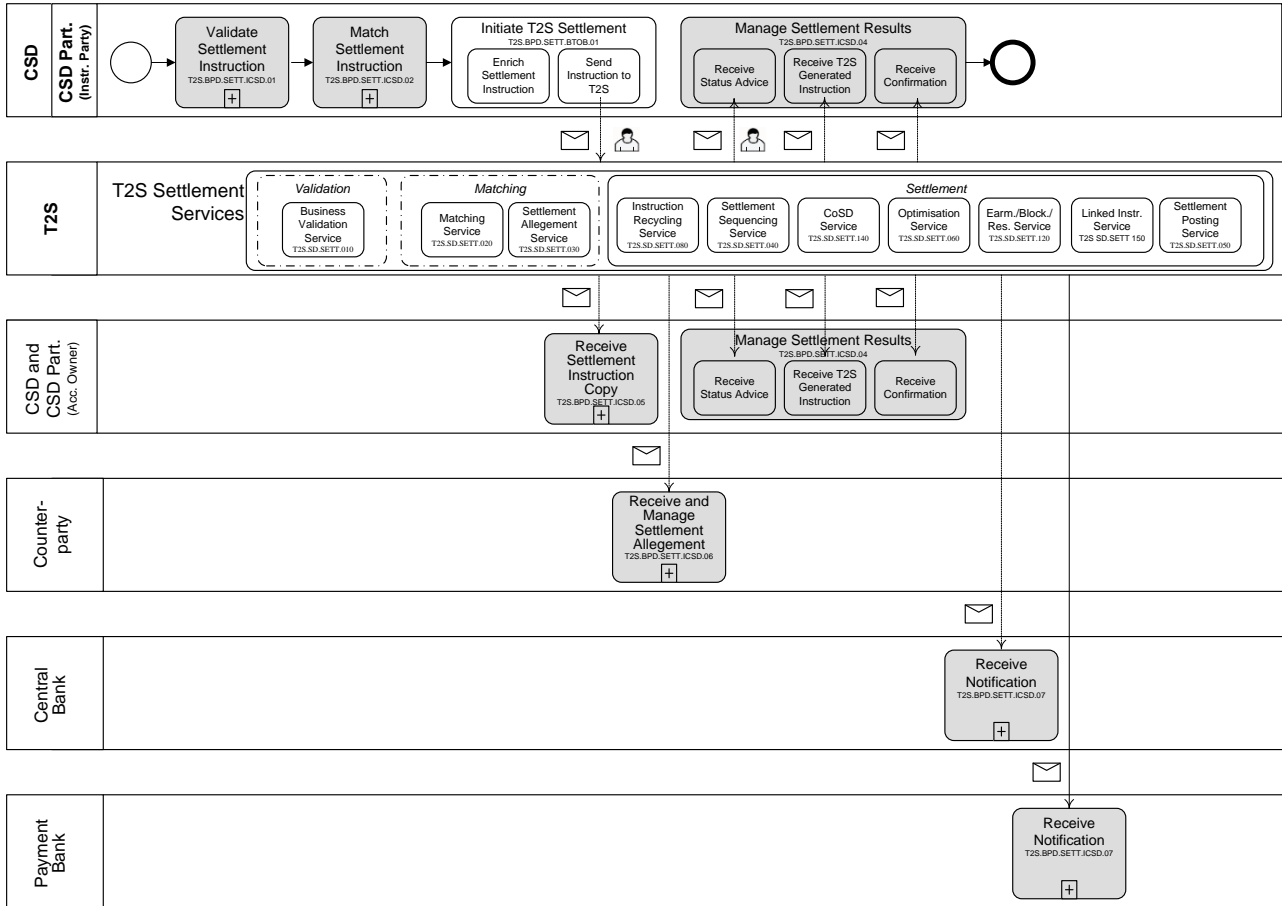

3

4 **4.4.3 BUSINESS PROCESS DESCRIPTION**

5 This Business Process Description is applicable to Scenario A and B unless otherwise noted. For the purpose
 6 of readability, the actor names in the text refer to Scenario A with the Scenario B actor indicated in square
 7 brackets.

8 **4.4.3.1 INITIATE T2S SETTLEMENT**

Reference ID	T2S.BPD.SETT.BTOB.01
--------------	----------------------

9 T2S Actors: CSD (Scenario A)/CSD Participant (Scenario B)

10 The CSD [CSD Participant] enriches the settlement instruction with details required for settlement
 11 processing in T2S and sends the settlement instruction to T2S.

12

1 References:

2 UDFS: Use Case “Send Settlement Instruction” (Chapter 2.3)

3 GUI BFD: T2S.GUI.SESE.INX.0070

4 **4.4.3.1.1 Enrich Settlement Instruction**

Reference ID	T2S.BPD.SETT.BTOB.01.01
--------------	-------------------------

5 The CSD [CSD Participant] enriches the settlement instructions with the details required by T2S. In the
 6 settlement instruction corresponding to the redelivery of securities, the CSD [CSD Participant] specifies the
 7 linkage to the instruction corresponding to the receipt of securities i.e. the CSD [CSD Participant] specifies
 8 the processing position as AFTE, and specifies either

- 9 • the settlement transaction identification (in case of single instruction corresponding to receipt of
 10 securities positions),
- 11 • pool reference (in case of multiple instructions corresponding to receipt of securities positions).

12 **4.4.3.1.2 Send Settlement Instruction to T2S**

Reference ID	T2S.BPD.SETT.BTOB.01.02
--------------	-------------------------

13 The CSD [CSD Participant] converts the settlement instructions enriched with T2S specific information and
 14 T2S process indicators into the required message format and transmits them to T2S.

15 The instruction of T2S is also possible via the T2S GUI.

16 The CSD [CSD Participant] sends the following message to T2S:

17 **Table 4-10: Messages to T2S [T2S.BPD.SETT.BTOB.01.02]**

Message Name	ISO Code	To/From T2S	UDFS Chapter
SecuritiesSettlementTransactionInstructionV03	Sese.023.001.03	To T2S	3.3.8.4

18 **4.4.3.2 T2S PROCESSING**

19 For details on the T2S services involved, refer to process “Intra-CSD Settlement [T2S.BPD.SETT.ICSD]”.

20

1 4.5 BASKET TRADES [T2S.BPD.SETT.BASK]

2 4.5.1 OVERVIEW

3 This process describes the act of settling basket trades in T2S. Basket trade refers to a single order to buy or
4 sell a set of securities. T2S actors may use basket trades for several purposes, for instance for trades resulting
5 from participants investing in a portfolio or for a basket of securities used as collateral⁵² against a single cash
6 amount.

7 This process is a variation of the core settlement process and applies to intra-CSD as well as cross-CSD and
8 external CSD settlement scenarios. For reason of clarity the diagram and description below refer to the intra-
9 CSD settlement only. For details refer to section “Core Settlement Processes”.

10 **Trigger:**

- 11 • The CSD or CSD Participant receives basket trade details from a trading facility or CSD Participant.

12 **Preconditions:**

13 None

14 **T2S Instructing Party:**

15 There are two scenarios for the instruction of T2S:

- 16 • Scenario A: CSD instructs T2S.
- 17 • Scenario B: CSD Participant instructs T2S.

⁵² The trades on collateral securities are created by T2S as part of client-collateralisation or auto-collateralisation.

1 **4.5.2 BUSINESS PROCESS DIAGRAM**

2 **Figure 4-5: Business Process Diagram [T2S.BPD.SETT.BASK]**

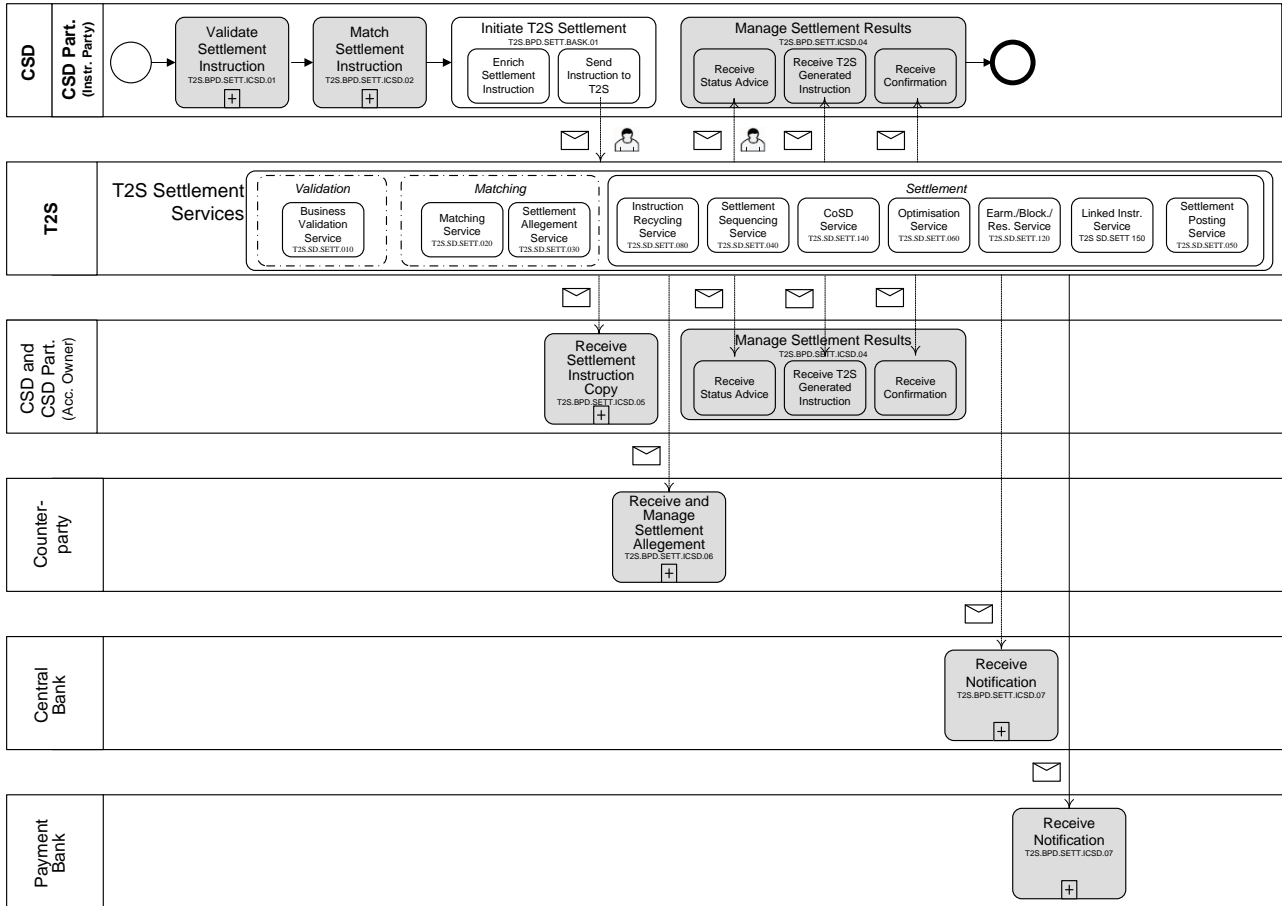

3

4 **4.5.3 BUSINESS PROCESS DESCRIPTION**

5 This Business Process Description is applicable to Scenario A and B unless otherwise noted. For the purpose
 6 of readability, the actor names in the text refer to Scenario A with the Scenario B actor indicated in square
 7 brackets.

8 **4.5.3.1 INITIATE T2S SETTLEMENT**

Reference ID	T2S.BPD.SETT.BASK.01
--------------	----------------------

9 T2S Actors: CSD (Scenario A)/CSD Participant (Scenario B)

10 The CSD [CSD Participant] enriches the settlement instruction with details required for settlement
 11 processing in T2S and sends the settlement instruction to T2S.

12

1 References:

2 UDFS: Use Case “Send Settlement Instruction” (Chapter 2.3)

3 GUI BFD: T2S.GUI.SESE.INX.0070

4 **4.5.3.1.1 Enrich Settlement Instruction**

Reference ID	T2S.BPD.SETT.BASK.01.01
--------------	-------------------------

5 The CSD [CSD Participant] enriches the settlement instructions and links the instructions by use of a pool
 6 reference. In each settlement instruction, the CSD [CSD Participant] specifies

- 7 • the pool reference,
 8 • the number of settlement instructions within the pool (pool counter),
 9 • the instruction processing on an “All or none” basis.

10 **4.5.3.1.2 Send Settlement Instruction to T2S**

Reference ID	T2S.BPD.SETT.BASK.01.02
--------------	-------------------------

11 The CSD [CSD Participant] converts the settlement instructions enriched with T2S specific information and
 12 T2S process indicators into the required message format and transmits them to T2S.

13 The instruction of T2S is also possible via the T2S GUI.

14 The CSD [CSD Participant] sends the following message to T2S:

15 **Table 4-11: Messages to T2S [T2S.BPD.SETT.BASK.01.02]**

Message Name	ISO Code	To/From T2S	UDFS Chapter
SecuritiesSettlementTransactionInstructionV03	Sese.023.001.03	To T2S	3.3.8.4

16 **4.5.3.2 T2S PROCESSING**

17 For details on the T2S services involved, refer to process “Intra-CSD Settlement [T2S.BPD.SETT.ICSD]”.

18

1 4.6 COUPON STRIPPING [T2S.BPD.SETT.CSTR]

2 4.6.1 OVERVIEW

3 This process describes the act of conducting coupon stripping in T2S. Coupon stripping is the financial
4 process in which the coupons are stripped off a bearer bond and then sold separately as a source of cash, with
5 no capital repayment; the bond, bereft of its coupons, becomes a zero-coupon bond and is also sold
6 separately.

7 One coupon component can represent either all the interest payments of a bond's life, or one individual
8 interest payment.

9 Usually the CSD Participant delivers via the CSDs their debt instrument positions back to the issuer and
10 receive securities positions (as new ISINs) on the stripped bond (zero coupon bond) and on the coupons.

11 This process is a variation of the core settlement process and applies to intra-CSD as well as cross-CSD and
12 external CSD settlement scenarios. For reason of clarity the diagram and description below refer to the intra-
13 CSD settlement only. For details refer to section "Core Settlement Processes".

14 **Trigger:**

15 The CSD receives CSD Participant's instruction for stripping the debt instrument

16 **Preconditions:**

17 Stripped bond ISIN, coupon ISINs are created in T2S by the Security Maintenance CSD.

18 **T2S Instructing Party:**

19 CSD

1 **4.6.2 BUSINESS PROCESS DIAGRAM**

2 **Figure 4-6: Business Process Diagram [T2S.BPD.SETT.CSTR]**

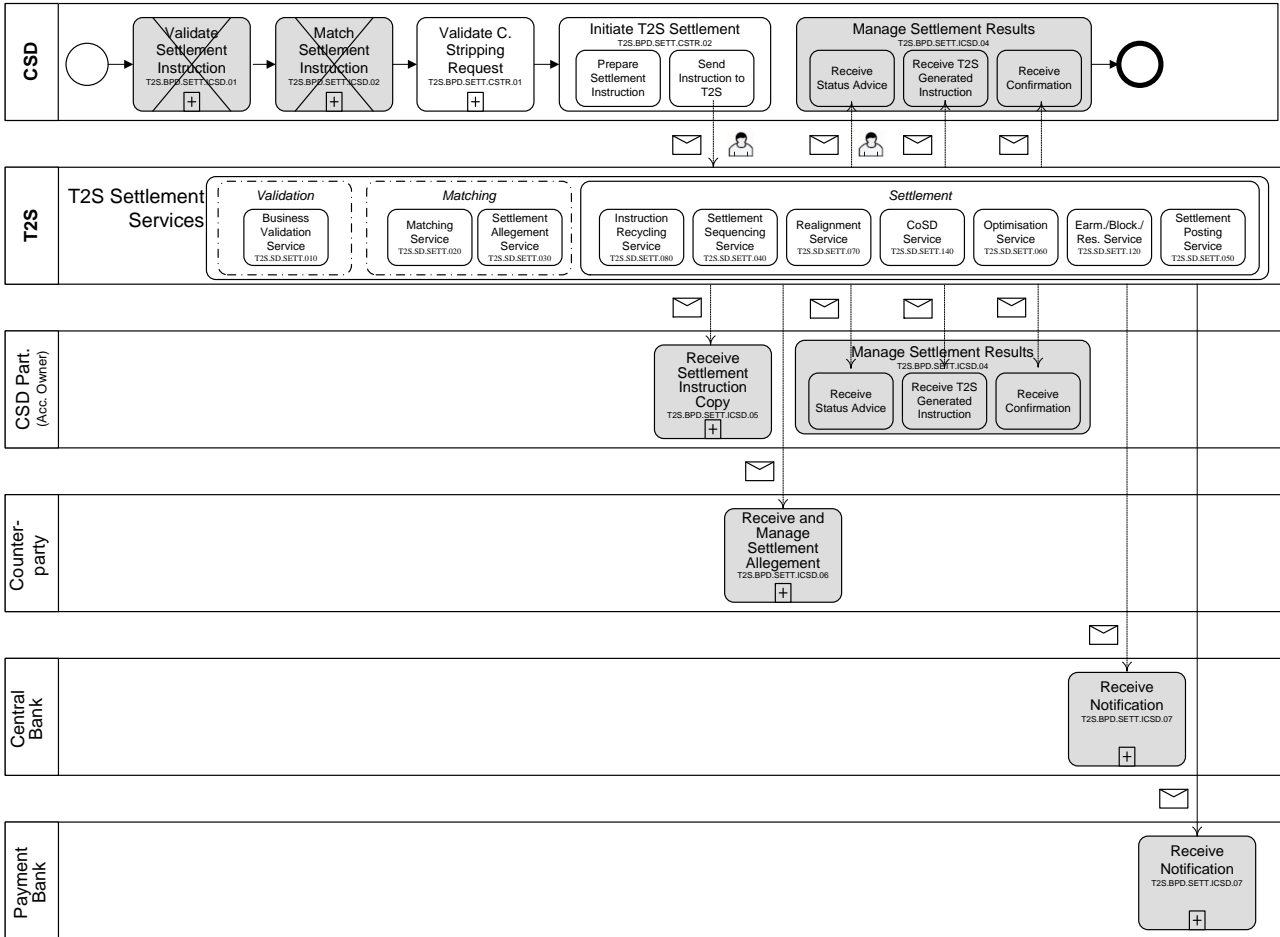

3

4 **4.6.3 BUSINESS PROCESS DESCRIPTION**

5 **4.6.3.1 VALIDATE COUPON STRIPPING REQUEST**

Reference ID	T2S.BPD.SETT.CSTR.01
--------------	----------------------

6 T2S Actors: CSD

7 The CSD receives request for coupon stripping from its participants (investors). The CSD may validate the
 8 request for the correctness of data, and also for the securities positions of the requesting participant.

9

1 **4.6.3.2 INITIATE T2S SETTLEMENT**

Reference ID	T2S.BPD.SETT.CSTR.02
--------------	----------------------

2 T2S Actors: CSD

3 The CSD creates the following settlement instructions in order to manage the coupon stripping process:

- 4 • Two FOPs on the original debt instrument: one delivery settlement instruction from the investor’s
 5 securities account to the issuer’s securities account in T2S (both investor and issuer are CSD
 6 Participants) and counter settlement instruction (receive securities into the issuer’s account).
- 7 • The CSD creates two FOP receipt settlement instructions for the investor to receive securities positions
 8 on stripped bond and coupons from the issuer’s securities account⁵³ in T2S i.e. the CSD instructs T2S.
- 9 ○ One FOP receipt instruction for the investor receiving stripped bond,
 10 ○ One FOP receipt instruction each for the investor receiving the coupons.
- 11 • The CSD also creates the counter settlement instruction to deliver the securities positions from the
 12 issuer’s securities account to the investor.

13 The CSD links the above FOP delivery and receipt instructions with the intent of settling them together.
 14 There are two options for linking these instructions by either specifying a “WITH” link between them or
 15 specifying the same pool reference in all instructions.

16

⁵³ The Issuer CSD should issue the securities positions on the stripped bond, coupons. Issuer CSD could link the issuance instructions with the instructions delivering those securities from its account. Refer BPD Issuance of securities [T2S.BPD.SETT.ISSU].

1 **Figure 4-7: Example of Coupon Stripping [T2S.BPD.SETT.CSTR.02]**

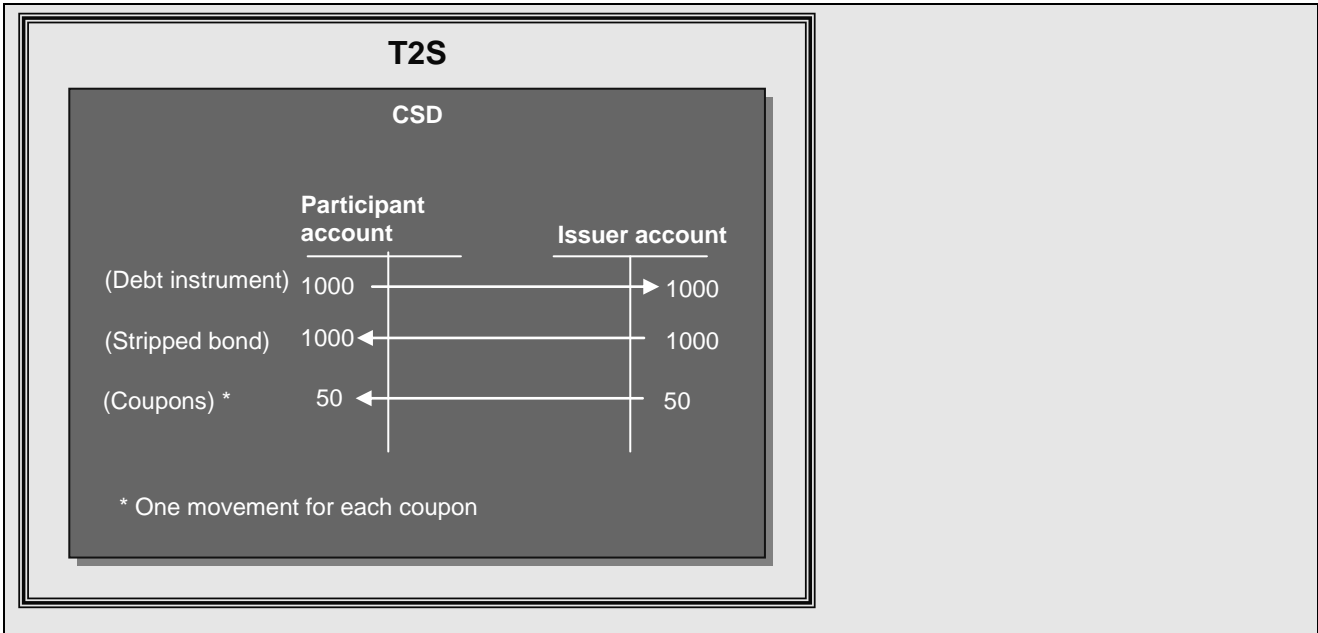

Original debt instrument positions (1000) are delivered from participant’s account to Issuance account of the Issuer.

Stripped bond positions (1000) and Coupons positions corresponding to the stripped coupons (50) are delivered from Issuer account to participant’s account. A 5% interest rate is assumed in this example and coupons are denominated in face amount.

2 **References:**

3 UDFS: Use Case “Send Settlement Instruction” (Chapter 2.3)

4 GUI BFD: T2S.GUI.SESE.INX.0070

5 **4.6.3.3 T2S PROCESSING**

6 For details on the T2S services involved, refer to process “Intra-CSD Settlement [T2S.BPD.SETT.ICSD]”.

7

1 **4.7 COUPON RECONSTITUTION [T2S.BPD.SETT.CREC]**

2 **4.7.1 OVERVIEW**

3 This process describes the act of conducting a coupon reconstitution in T2S. Coupon reconstitution is the
4 reverse process to coupon stripping. The process includes recombining all the coupons that have not reached
5 their maturity and the principal component to reconstitute the original debt instrument.

6 The CSD delivers the stripped bond positions and coupon positions to the issuer. Simultaneously, the CSD
7 receives securities positions on the original debt instrument from the issuer.

8 This process is a variation of the core settlement process and applies to intra-CSD as well as cross-CSD and
9 external CSD settlement scenarios. For reason of clarity the diagram and description below refer to the intra-
10 CSD settlement only. For details refer to section “Core Settlement Processes”.

11 **Trigger:**

12 There are two possible triggers that initiate the coupon reconstitution process.

- 13 • Trigger A: At the end of each interest-bearing period the CSD initiates the reconstitution of all bond
14 positions with attached coupons of the next interest-bearing period
- 15 • Trigger B: The CSD receives a reconstitution notice from CSD Participant, for a specific securities
16 position

17 **Preconditions:**

18 The stripping process of the original debt instrument has taken place.

19 **T2S Instructing Party:**

20 CSD

1 **4.7.2 BUSINESS PROCESS DIAGRAM**

2 **Figure 4-8: Business Process Diagram [T2S.BPD.SETT.CREC]**

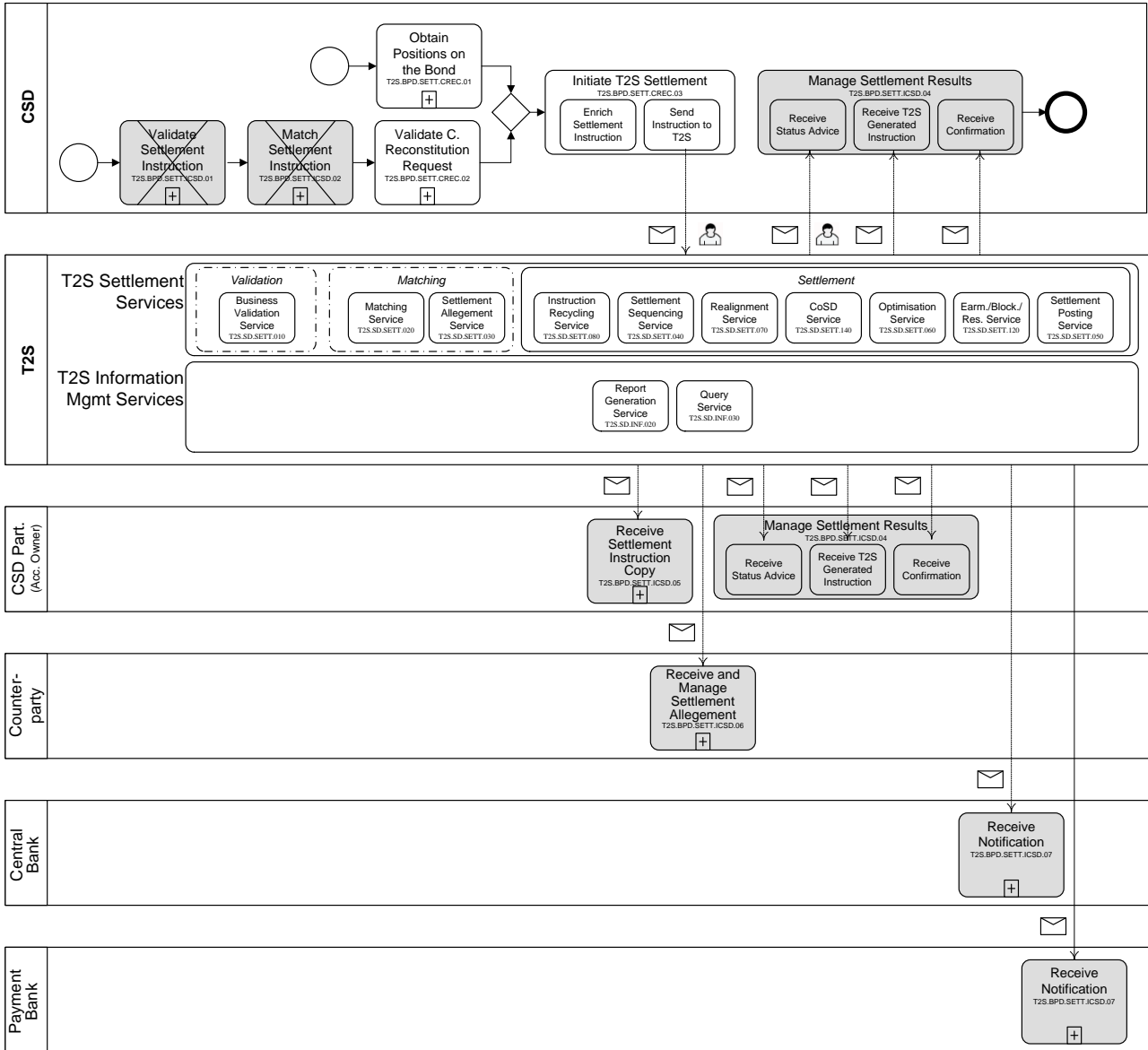

3

4 **4.7.3 BUSINESS PROCESS DESCRIPTION**

5 **4.7.3.1 OBTAIN POSITIONS ON THE BOND**

Reference ID	T2S.BPD.SETT.CREC.01
--------------	----------------------

6 T2S Actors: CSD (Trigger A)

7 The CSD obtains from T2S the securities positions on the stripped bond with attached coupons of the next
8 interest-bearing period.

9 The CSD has two options for receiving T2S information:

- 1 • option 1: the CSD receives these details through predefined reports generated by T2S at close of business
- 2 of settlement day (End of Day reporting),
- 3 • option 2: the CSD queries T2S by specifying the stripped bond ISIN as a filter criterion
- 4 In option 1:
- 5 • based on its report subscription set up in T2S, the CSD receives periodical statements and delta
- 6 statements of holdings reports,
- 7 • the CSD filters the reports in order to extract details relevant to the stripped bond.
- 8 In option 2:
- 9 • the CSD queries T2S for securities positions related to the stripped bond.
- 10 The CSD sends/ receives the following messages to/from T2S:

11 **Table 4-12: Messages to and from T2S [T2S.BPD.SETT.CREC.01]**

Message Name	ISO Code	To/From T2S	Event	UDFS Chapter
Securities Account Position (History) Query	semt.025.001.01	To T2S	-	3.3.7.11
SecuritiesStatusOr StatementQueryStatusAdviceV03	sese.022.001.03	From T2S	Query instruction is processed in T2S	3.3.8.3
SecuritiesBalanceCustodyReport	semt.002.001.05	From T2S	Time/event based	3.3.7.1

- 12 References:
- 13 UDFS: Use Cases “Send Query” (Chapter 2.18) and “Receive Report” (Chapter 2.19)
- 14 GUI BFD: T2S.GUI.SESE.INX.0070

15 **4.7.3.2 VALIDATE COUPON RECONSTITUTION REQUEST**

Reference ID	T2S.BPD.SETT.CREC.02
--------------	----------------------

- 16 T2S Actors: CSD (Trigger B)
- 17 The CSD receives request for coupon reconstitution from its participants. The CSD may validate the request
- 18 for the correctness of data, and also for the securities positions of the requesting participant.

1 **4.7.3.3 INITIATE T2S SETTLEMENT**

Reference ID	T2S.BPD.SETT.CREC.03
--------------	----------------------

2 T2S Actors: CSD

3 In case of Trigger A, the CSD initiates this process for each of the stripped bond position that it identifies
 4 from the report in process “Obtain positions in the Bond” [T2S.BPD.SETT.CREC.01].

5 In case of Trigger B, the CSD initiates this process only for the specific position requested for reconstitution
 6 by the CSD Participant.

7 The CSD creates T2S settlement instructions in order to facilitate the coupon reconstitution process. The
 8 indicative instruction type (from CSD Participant’s perspective) is as below:

9 **Table 4-13: Settlement Instruction for Coupon Reconstitution [T2S.BPD.SETT.CREC.03]**

Trigger	Instruction Type	ISIN	Quantity	Securities accounts
A	FOP delivery	Stripped bond	Stripped bond positions of the participant	From participant’s account To issuer’s account
	FOP receipt	Original bond	Stripped bond positions of the participant	From Issuer’s account ⁵⁴ To participant’s account
B	FOP delivery	Stripped bond	Stripped bond positions of the participant	From participant’s account To issuer’s account
	FOP delivery (One for each coupon)	Coupon of the next Interest-bearing period	Coupon positions calculated based on the interest rate, participant’s positions	From participant’s account To issuer’s account
	FOP receipt	Original bond	Stripped bond positions of the participant	From Issuer’s account To participant’s account

10 The CSD also creates the counter settlement instruction to receive/ deliver the securities positions from the
 11 issuer’s securities account.

⁵⁴ The Issuer CSD should reduce the issued securities positions on the stripped bond, coupons. Issuer CSD could link the instructions reducing the issued positions, with the instructions receiving those securities into its account.

1 The CSD links the FOP delivery, FOP receipt instructions with the intent of settling them together. There are
 2 two options for linking these instructions by either specifying a “WITH” link between them or specifying the
 3 same pool reference in all instructions. (Refer to UDFS 1.6.1.11 Linked Instructions).

4 **Figure 4-9: Example of Coupon Reconstitution [T2S.BPD.SETT.CREC]**

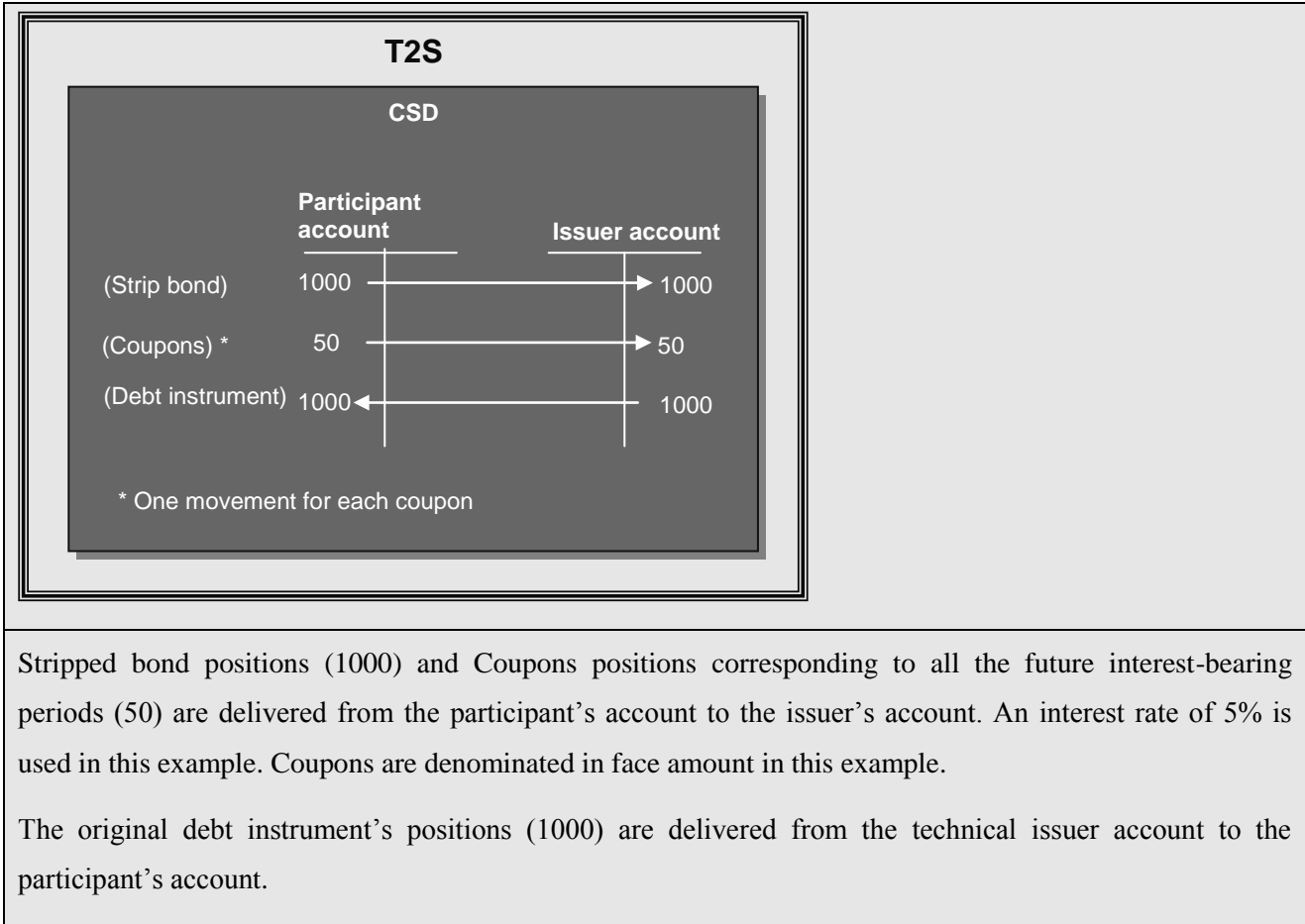

5 References:

6 UDFS: Use Case “Send Settlement Instruction” (Chapter 2.3)

7 GUI BFD: T2S.GUI.SESE.INX.0070

8 **4.7.3.4 T2S PROCESSING**

9 In order to obtain the positions on the bond, either the **Report Generation Service (T2S.SD.INF.020)** or the
 10 **Query Service (T2S.SD.INF.030)** can be used. The **Report Generation Service (T2S.SD.INF.020)**
 11 generates and sends the statement of holdings report and the delta statement of holdings reports after the
 12 close of daytime settlement or at any other time as specified in the report subscription.

- 13 • Statement of Holdings – This report includes details of all securities positions of all ISINs held in the
 14 respective CSD securities accounts.

1 • Delta statement of holdings – This report includes changes in the quantity of securities positions, i.e. the
2 net quantity which has been debited or credited on the reported positions since the creation of the
3 previous Statement of Holdings.

4 Alternatively, the **Query Service (T2S.SD.INF.030)** can be used to get information about the securities
5 positions (current and history) in the stripped bond as a query result.

6 For details on the remaining T2S services involved, refer to “Intra-CSD Settlement
7 [T2S.BPD.SETT.ICSD]”.

8

1 **4.8 BUY IN AND SELL OUT [T2S.BPD.SETT.BISO]**

2 **4.8.1 OVERVIEW**

3 This process describes the act of conducting buy-in or a sell-out in T2S. Some markets allow CSD
4 Participants to choose a Central Counter Party (CCP) for their trades. In this case the CCP becomes the
5 counterparty for all the trades concluded by its participants. A buy-in procedure is initiated in order to settle
6 failed deliveries of a CCP member i.e. an instruction that is not settled within a specified number of days
7 after its intended settlement date. The buy-in procedure aims at finding another seller of the security such
8 that the CCP is able to deliver the security to the buyer. The price difference between the buy-in price of the
9 security and the original price is usually charged to the original failing seller.

10 Similarly, if the buyer of the trade does not provide cash amount after a certain market-specific number of
11 days beyond the Intended Settlement Date, the CCP will initiate a sell-out procedure.

12 The buy in / sell out procedure is usually preceded by a securities lending attempt.

13 **Trigger:**

- 14 • Buy-in: The CCP (as CSD Participant) receives a "lack of securities" status advice from T2S. Normally,
15 a securities lending/borrowing procedure would follow. If borrowing securities is not successful, the buy
16 in process is triggered.
- 17 • Sell-out: The CCP (as CSD Participant) receives a "lack of cash" status advice from T2S.

18 **Preconditions:**

19 None

20 **T2S Instructing Party:**

21 CCP (as CSD Participant)

1 **4.8.2 BUSINESS PROCESS DIAGRAM**

2 **Figure 4-10: Business Process Diagram [T2S.BPD.SETT.BISO]**

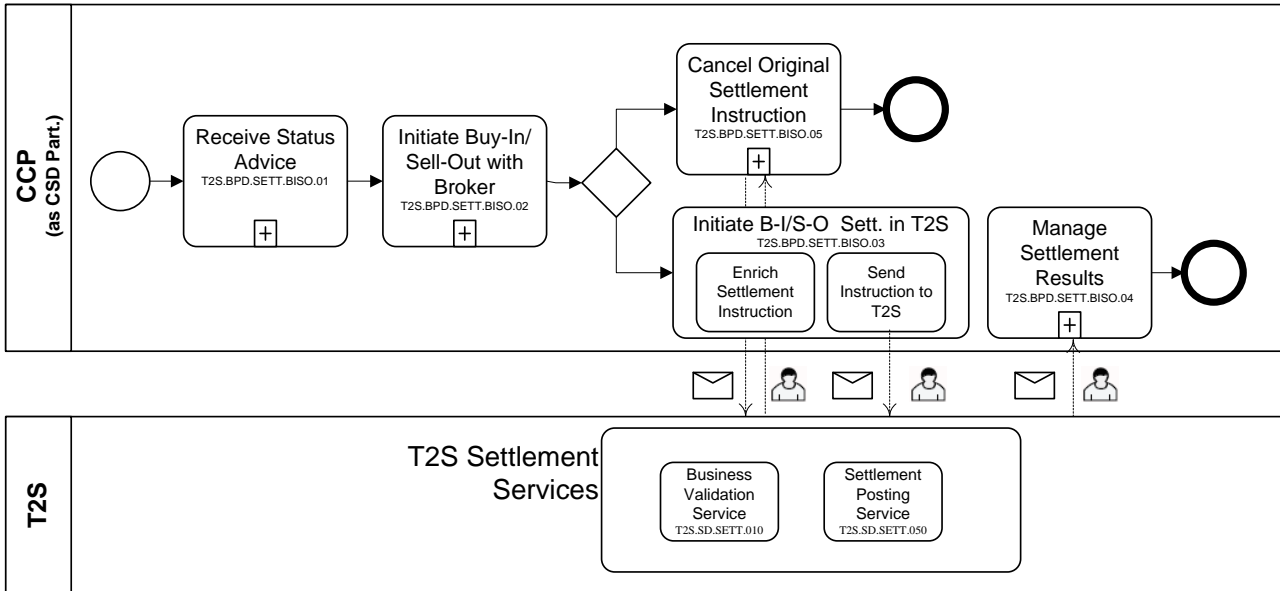

3

4 **4.8.3 BUSINESS PROCESS DESCRIPTION**

5 **4.8.3.1 RECEIVE STATUS ADVICE**

Reference ID	T2S.BPD.SETT.BISO.01
--------------	----------------------

6 T2S Actors: CCP (as CSD Participant)

7 The CCP receives the status advices on the settlement instructions, specifying reason as “lack of securities”
8 and/or “lack of cash”.

9 **4.8.3.2 INITIATE BUY-IN/SELL-OUT WITH BROKER**

Reference ID	T2S.BPD.SETT.BISO.02
--------------	----------------------

10 T2S Actors: CCP (as CSD Participant)

11 After a certain number of market-specific days from the Intended Settlement Date the CCP initiates the buy-
12 in/sell-out procedure.

- 13 • In case of failure of the delivery from seller to CCP, the CCP instructs an external broker or agent for
14 buy-in of securities. The CCP informs the failing seller about the initiation of the buy-in procedure.
- 15 • In case of failure of the delivery from CCP to buyer, the CCP instructs an external broker or agent for
16 sell-out of securities. The CCP informs the failing buyer about the initiation of the sell-out procedure.

1 The broker or agent attempts to find a counter party for the buy-in/sell-out of securities. Once the trade is
 2 concluded the CCP receives a trade confirmation from the broker.

3 **4.8.3.3 INITIATE SETTLEMENT OF BUY-IN/SELL-OUT IN T2S**

Reference ID	T2S.BPD.SETT.BISO.03
--------------	----------------------

4 T2S Actors: CCP (as CSD Participant)

- 5 • In case of a buy-in the CCP prepares a new settlement instruction to receive the securities of the buy-in
 6 from the broker or agent into CCP’s securities account. The CCP could link this new settlement
 7 instruction with the original settlement instruction delivering securities from CCP to the buyer, using a
 8 WITH (all-or-none basis) indicator. The linking is to ensure that the buy-in securities are used to settle
 9 the delivery from CCP to buyer.
- 10 • In case of a sell-out the CCP prepares a new settlement instruction to deliver the securities from CCP to
 11 the broker or agent. Similarly this instruction could be linked with the original settlement instruction
 12 delivering securities from seller to CCP.

13 For details on the instruction of T2S for intra-CSD settlement, refer to process “Intra-CSD Settlement
 14 [T2S.BPD.SETT.ICSD]”.

15 **4.8.3.4 MANAGE SETTLEMENT RESULTS**

Reference ID	T2S.BPD.SETT.BISO.04
--------------	----------------------

16 T2S Actors: CCP (as CSD Participant)

17 The CCP receives status messages, notifications and confirmations from T2S related to the settlement
 18 instructions.

19 For details on the messages received as a result of intra-CSD settlement, refer to process “Intra-CSD
 20 Settlement [T2S.BPD.SETT.ICSD]”.

21 **4.8.3.5 CANCEL ORIGINAL SETTLEMENT INSTRUCTION**

Reference ID	T2S.BPD.SETT.BISO.05
--------------	----------------------

22 T2S Actors: CCP (as CSD Participant)

23 In case the buy-in/sell-out is not successful, the CCP initiates cancellation of the original settlement
 24 instruction (i.e. transactions between seller and CCP, CCP and buyer) by sending cancellation instructions to
 25 T2S. Subsequently, the CCP initiates a cash compensation claim.

1 For details on the cancellation of a settlement instruction, refer to process “Cancellation of Settlement
2 Instruction [T2S.BPD.SETT.CINS]”.

3 **4.8.3.6 T2S PROCESSING**

4 For details on the T2S services involved, refer to process “Intra-CSD Settlement [T2S.BPD.SETT.ICSD]”.

5

1 **4.9 MARK-UP/ MARK-DOWN OF SECURITIES POSITIONS**
2 **[T2S.BPD.SETT.MKUP]**

3 This process describes the act of conducting a mark-up or mark-down of securities positions in T2S. Issuers
4 and Issuer Agents conduct mark-ups/mark-downs of the securities positions which are issued and held at the
5 Issuer CSD. The Issuer or Issuer Agent may require to mark-up/mark-down issued positions due to e.g. a
6 repurchase, the realigning proceeds of corporate event etc.

7 The Issuer, Issuer Agent or Issuer CSD of the ISIN instructs T2S to mark-up/mark-down the securities
8 positions in the issuance account.

9 A precondition for mark down of securities is that the securities positions must be available for withdrawal.

10 The mark-up/mark-down settlement takes place as a movement of positions from the issuance account to
11 distribution account. For details refer to the activities “Initiate T2S Settlement [T2S.BPD.SETT.ISSU.02]”
12 and “Manage Settlement Results [T2S.BPD.SETT.ISSU.03]” in the process “Issuance of Securities
13 [T2S.BPD.SETT.ISSU]”.

14

1 **4.10 FUND SHARES SUBSCRIPTION [T2S.BPD.SETT.FNDS]**

2 **4.10.1 OVERVIEW**

3 This process describes the act of distributing fund shares in the securities accounts of a CSD. Today, there is
4 not a single harmonised model for investment fund shares distribution and settlement in the EU. Different
5 markets follow different processes. In some cases the funds Transfer Agent⁵⁵ offers the full registration,
6 distribution and settlement service to the fund issuer/manager. In other cases, the local CSD provides the
7 settlement and notary services to the Transfer Agent.

8 The only relevant scenario in the context of T2S relates to fund shares settlement processes in CSD securities
9 accounts. Therefore, this BPD section focuses on generic elements of fund shares settlement and in particular
10 on the CSD – T2S services interaction during issuance, distribution and settlement of investment fund shares.

11 The following subscription cases were considered:

- 12 1. the investor approaches the Fund Instructor⁵⁶ for subscription of the fund shares,
- 13 2. the Fund Instructor communicates the details of the subscription order to the Transfer Agent,
- 14 3. the Fund Instructor receives from the Transfer Agent the confirmation of the order,
- 15 4. the Fund Instructor⁵⁷ and the Transfer Agent instruct the CSD with the relevant securities settlement
16 instructions,
- 17 5. the Fund Instructor and the Transfer Agent instruct the settlement/payment agent with the relevant
18 movement of cash⁵⁸,
- 19 6. the Transfer Agent increases the fund positions (issuance) in the CSD accounts.

20 Cases 1, 2 and 3 are outside the scope of this BPD description since they refer to the order routing and not
21 the settlement process. Cases 4, 5 and 6 are relevant in the context of T2S, in case the CSD settlement model
22 is used by the relevant market.

23 One working assumption is that the Fund Instructor and the Transfer Agent are participants of the CSD and
24 they have T2S Dedicated Cash Accounts (DCA) or make use of a Payment Bank DCAs in T2S.

25 In case of cross-CSD subscriptions, the non-domicile Fund Instructor can either be a foreign participant of
26 the issuer CSD or can hold funds via its local CSD (investor CSD) which maintains a link to the issuer CSD.

⁵⁵ A Transfer Agent is an entity appointed by the fund management company that processes subscription, redemption and switch orders and usually maintains the register of shareholders. The functions performed by the Transfer Agent may slightly vary by country. In some countries the depotbank is in charge of the issuing process as well as for the mark up and down instructions because a Transfer Agent does not exist

⁵⁶ The Fund Instructor is - depending on the market model - an Investor, Distributor, Platform Hub or a Custodian.

⁵⁷ In case the Fund Instructor is different from the client-custodian, the client-custodian instructs the CSD for securities settlement.

⁵⁸ In some markets the securities and cash movement is simultaneous (i.e. steps 4 and 5)

1 In the latter case, a cross-CSD link must be established between issuer CSD and investor CSD. For details on
 2 the set-up of Cross-CSD Settlement Links, refer to process “Maintenance of Cross-CSD Settlement Links
 3 and Securities Eligibility [T2S.BPD.STDA.MCSL]”. The Fund Instructor will be a participant of the investor
 4 CSD and Transfer Agent will be a participant of the issuer CSD. The Fund Instructor instructs T2S through
 5 the investor CSD or directly (as a T2S directly connected party - DCP). The Transfer Agent instructs T2S
 6 through the issuer CSD or directly (as DCP). SIs from the Fund Instructor and Transfer Agent will be
 7 matched in T2S.

8 From the perspective of T2S settlement, the redemption process is identical to the subscription process, with
 9 the reverse movements of securities and cash from/to the relevant securities accounts/DCAs.

10 **Trigger:**

11 The Fund Instructor receives funds subscription order from investor.

12 **Preconditions:**

13 None

14 **T2S Instructing Party:**

15 Fund Instructor and Transfer Agent

16 **4.10.2 BUSINESS PROCESS DIAGRAM**

17 **Figure 4-11: Business Process Diagram [T2S.BPD.SETT.FNDS]**

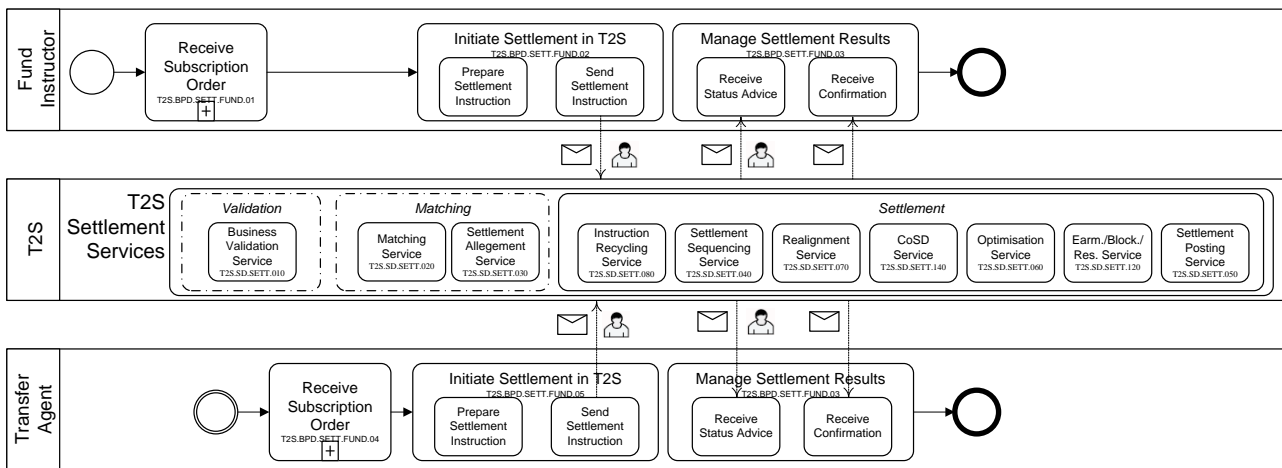

18 **4.10.3 BUSINESS PROCESS DESCRIPTION**

19 **4.10.3.1 RECEIVE SUBSCRIPTION ORDER**

Reference ID	T2S.BPD.SETT.FNDS.01
--------------	----------------------

20 T2S Actors: Fund Instructor

1 The Fund Instructor receives a subscription order from the investor. The Fund Instructor communicates the
 2 subscription order details to the Transfer Agent. The Transfer Agent acknowledges/confirms the subscription
 3 order.

4 **4.10.3.2 INITIATE T2S SETTLEMENT**

Reference ID	T2S.BPD.SETT.FNDS.02
--------------	----------------------

5 T2S Actors: Fund Instructor

6 The Fund Instructor⁵⁹ prepares and sends the settlement instruction to T2S.

7 **4.10.3.2.1 Prepare Instruction**

Reference ID	T2S.BPD.SETT.FNDS.02.01
--------------	-------------------------

8 The Fund Instructor creates a settlement instruction to T2S. In the instruction, the fund instructor specifies
 9 the accounts (securities account and DCA) of the investor or itself.

10 Prior to this, the subscription order must have been confirmed by the Transfer Agent.

11 The Fund Instructor creates the T2S settlement instruction as an RVP⁶⁰ (receive versus payment) instruction,
 12 specifying the counterparty as Transfer Agent.

13 **4.10.3.2.2 Send Instruction to T2S**

Reference ID	T2S.BPD.SETT.FNDS.02.02
--------------	-------------------------

14 The Fund Instructor sends settlement instructions to T2S.

15 The instruction of T2S is also possible via the T2S GUI.

16 The Fund Instructor sends the following message to T2S:

17 **Table 4-14: Messages to T2S [T2S.BPD.SETT.FNDS.02.02]**

Message Name	ISO Code	To/From T2S	UDFS Chapter
SecuritiesSettlementTransactionInstructionV03	Sese.023.001.03	To T2S	3.3.8.4

⁵⁹ In case Fund Instructor is a directly connected participant (DCP) of T2S, the communication with T2S is direct; otherwise it is via the CSD.

⁶⁰ In case the cash and securities movements are not simultaneous, Fund instructor could create an FOP (free of payment) instruction.

1 **4.10.3.3 RECEIVE SUBSCRIPTION ORDER**

Reference ID	T2S.BPD.SETT.FNDS.04
--------------	----------------------

2 T2S Actors: Transfer Agent

3 The Transfer Agent receives a subscription order from the Fund Instructor. The Transfer Agent
 4 acknowledges/confirms the subscription order to the Fund Instructor. This process takes place without
 5 involving T2S communication.

6 **4.10.3.4 INITIATE T2S SETTLEMENT**

Reference ID	T2S.BPD.SETT.FNDS.05
--------------	----------------------

7 T2S Actors: Transfer Agent

8 The Transfer Agent⁶¹ prepares and sends the settlement instruction to T2S.

9 **4.10.3.4.1 Prepare Instruction**

Reference ID	T2S.BPD.SETT.FNDS.05.01
--------------	-------------------------

10 The Transfer Agent creates a T2S SI and specifies its accounts (securities account, DCA).

11 Prior to this the subscription order must have been confirmed by the Transfer Agent.

12 The Transfer Agent creates the T2S settlement instruction to as a DVP⁶² (delivery versus payment)
 13 instruction, specifying the counter party as Fund Instructor.

14 Depending on the national fund issuance process, the Transfer Agent may increase the funds outstanding
 15 amount in T2S before the distribution of fund shares to investors. In order to prepare the issuance of the
 16 fund, the Transfer Agent prepares a T2S settlement instruction as already-matched “Free of payment” (FOP).

17 The Transfer Agent specifies its issuance account in the delivery leg of the instruction and specifies its
 18 distribution account in the receive leg of the instruction.

19 The Transfer Agent could also link the settlement instructions related to the funds issuance with the
 20 settlement instructions related to distribution of fund shares to the investors in order to ensure that the funds
 21 are distributed only after the issuance has been completed. There are two options for linking these
 22 instructions in T2S: either by specifying a “WITH” link between them or by specifying the same pool
 23 reference in all instructions.

⁶¹ In case Transfer Agent is a directly connected participant (DCP) of T2S, the communication with T2S is direct; otherwise it is via the CSD.

⁶² In case the cash and securities movements are not simultaneous, the Transfer Agent could create an FOP (free of payment) instruction.

1 **4.10.3.4.2 Send Instruction to T2S**

Reference ID	T2S.BPD.SETT.FNDS.05.02
--------------	-------------------------

2 The Transfer Agent converts the settlement instruction enriched with T2S specific information and T2S
 3 process indicators into the required message format and transmits it to T2S.

4 The instruction of T2S is also possible via the T2S GUI.

5 The Transfer Agents sends the following message to T2S:

6 **Table 4-15: Messages to T2S [T2S.BPD.SETT.FNDS.05.02]**

Message Name	ISO Code	To/From T2S	UDFS Chapter
SecuritiesSettlementTransactionInstructionV03	Sese.023.001.03	To T2S	3.3.8.4

7 **4.10.3.5 T2S PROCESSING**

8 For details on the T2S services involved, refer to process “Intra-CSD Settlement [T2S.BPD.SETT.ICSD]”.

9 **4.10.3.6 MANAGE SETTLEMENT RESULTS**

Reference ID	T2S.BPD.SETT.FNDS.03/ T2S.BPD.SETT.FNDS.06
--------------	--

10 T2S Actors: Fund Instructor and Transfer Agent

11 The Fund Instructor and Transfer Agent receive the settlement related messages from T2S and initiate related
 12 internal processes.

13 The Fund Instructor and Transfer Agent receive the following message from T2S:

14 **Table 4-16: Messages from T2S [T2S.BPD.SETT.ICSD.04.01]**

Message Name	ISO Code	To/From T2S	Event	UDFS Chapter
SecuritiesSettlementTransactionStatusAdviceV03	Sese.024.001.03	From T2S	Change in status of settlement instruction	3.3.8.5
SecuritiesSettlementTransactionConfirmationV03	Sese.025.001.03	From T2S	Partial or Full settlement of the settlement instruction	3.3.8.6

15 References:

16 UDFS: Use Case “Send Settlement Instruction” (Chapter 2.3)

1 **Figure 4-12: Domestic subscription of fund shares in the context of T2S [T2S.BPD.SETT.ICSD.04.01]**

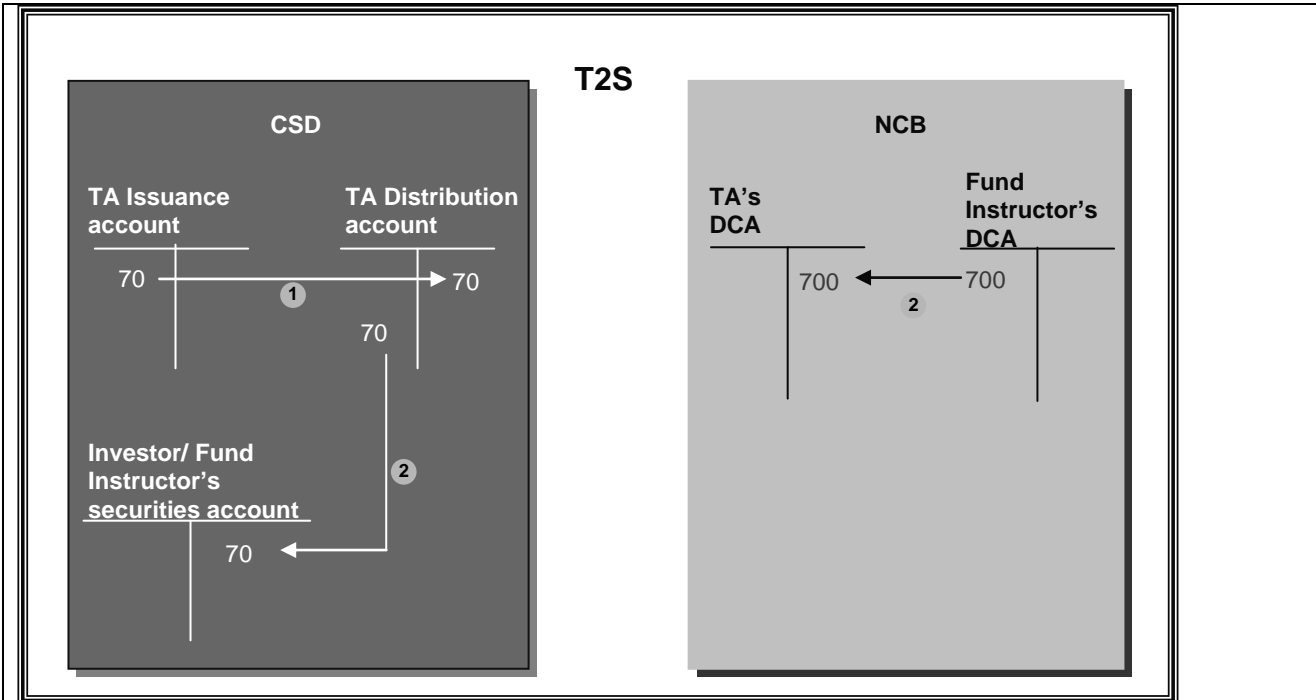

- Step 1: Upon receiving the issuance Settlement Instruction from the Transfer Agent, T2S increases the fund share positions by debiting 70 positions from the Transfer Agent Issuance account and by crediting 70 positions into the Transfer Agent Distribution account. The CSD maintains both securities accounts for the Transfer Agent in T2S. In some markets the issuance process (step 1), and distribution process (step 2) are not linked and could be executed at different points of time.
- Step 2: Upon receiving and matching the Settlement Instruction from the Fund Instructor and the Transfer Agent, T2S debits 70 positions from the “Transfer Agent Distribution” account and credits the Investor’s/ Fund Instructor’s securities account. T2S simultaneously debits the cash amount (700 EUR) from the Fund Instructor’s Dedicated Cash Account (DCA) and credits into Transfer Agent’s Dedicated Cash Account.

1 **Figure 4-13: Cross CSD subscription of fund shares in the context of T2S [T2S.BPD.SETT.ICSD.04.01]**

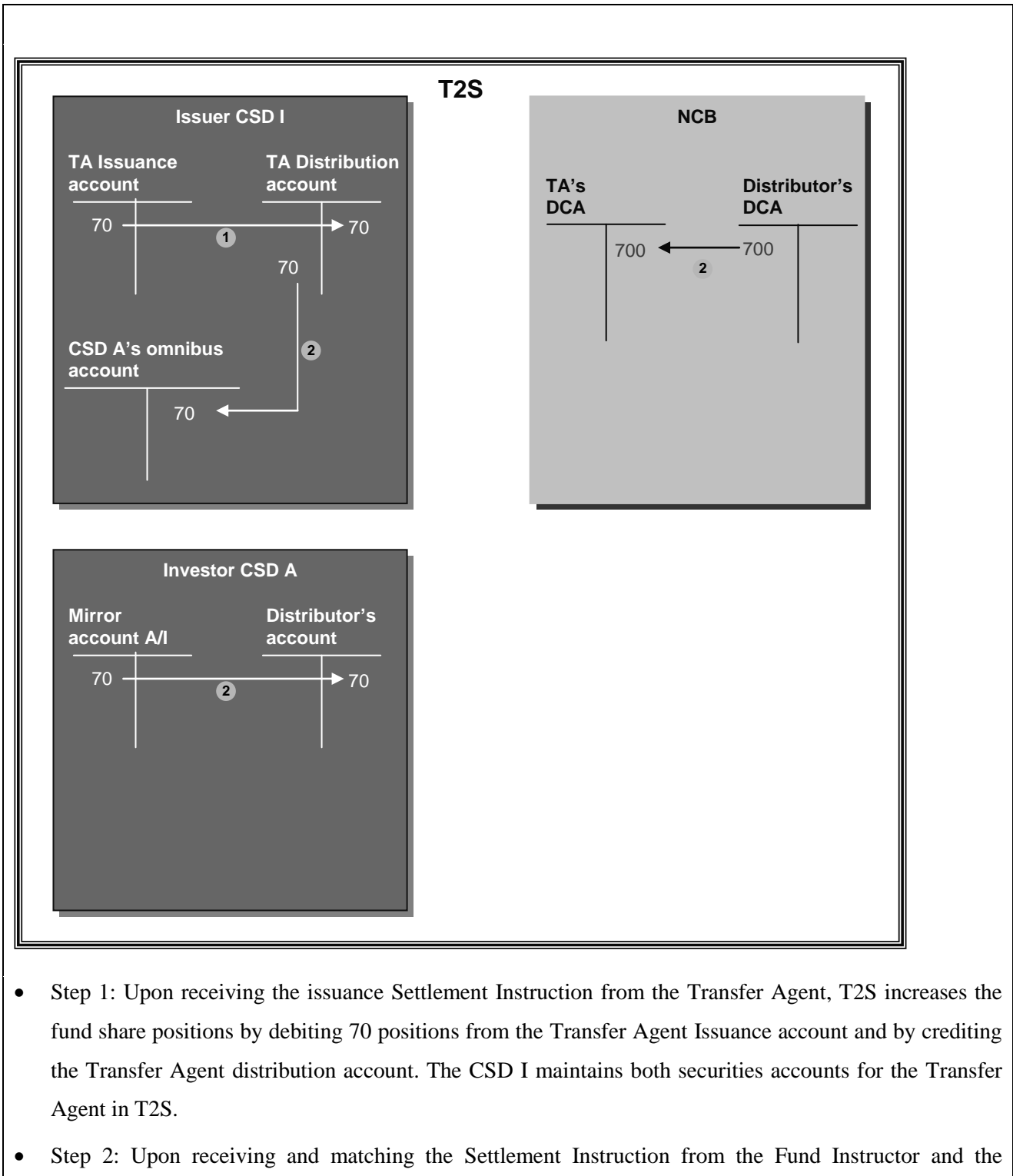

- Step 1: Upon receiving the issuance Settlement Instruction from the Transfer Agent, T2S increases the fund share positions by debiting 70 positions from the Transfer Agent Issuance account and by crediting the Transfer Agent distribution account. The CSD I maintains both securities accounts for the Transfer Agent in T2S.
- Step 2: Upon receiving and matching the Settlement Instruction from the Fund Instructor and the

Transfer Agent, T2S debits 70 positions from the “Transfer Agent Distribution” account and credits into CSD A’s omnibus account. T2S debits 70 positions from the Mirror account A/I⁶³ and credits the Investor’s/ Fund Instructor’s account in CSD A.

Simultaneously T2S debits cash amount (700 EUR) from the Fund Instructor’s Dedicated Cash Account (DCA) and credits into the Transfer Agent’s Dedicated Cash Account.

T2S automatically generates instructions to i) credit fund shares into CSD A’s omnibus account at CSD I, ii) debit from mirror account CSD A/I at CSD A.

1

⁶³ Mirror account in CSDA, reflecting the omnibus account at CSD I

1 **4.11 ACCOUNT TRANSFER OF SECURITIES [T2S.BPD.SETT.ATRA]**

2 This process describes the act of conducting an account transfer of securities in T2S. A CSD or CSD
3 Participant can use one or more securities accounts in T2S for the purposes of securities settlement. The CSD
4 or CSD Participant may also have the need to:

- 5 • rebalance securities positions between its securities accounts,
- 6 • make available the necessary securities positions in the right securities accounts for its securities
7 settlement including corporate actions,
- 8 • transfer either full or part of their holdings to another securities account to satisfy the need of
9 inheritance/ transfer of ownership of its end-clients/ portfolio transfer of securities to other clients.

10 The parties having such needs may instruct T2S, either themselves, via the CSD or via an authorised third
11 party (power of attorney). For example:

- 12 • A CSD Participant (acting as account operator or custodian and with privileges granted by its CSD)
13 receives instructions from their clients (e.g. end investors or financial institutions) to instruct directly in
14 T2S for such account transfers.
- 15 • A CSD receives instructions from its CSD Participant or third parties authorised by the CSD Participant
16 to instruct T2S on their behalf for such account transfers.

17 It is also possible that one or more securities accounts in T2S may need to be transferred from one custodian
18 to another. Such cases are handled via the transfer of securities accounts using the relationship of T2S Party
19 to Securities Accounts.

20 For details on the instruction of T2S and messages received, refer to processes “Intra-CSD Settlement
21 [T2S.BPD.SETT.ICSD]” and “Cross-CSD Settlement [T2S.BPD.SETT.CCSD]”.

1 **5. CORPORATE ACTIONS PROCESSES**

2 **5.1 DISTRIBUTIONS**

3 A distribution is a Corporate Action (CA) event whereby the issuer of a security delivers particular proceeds
4 to the holder of the underlying security without affecting the underlying security.

5 **5.1.1 SECURITIES DISTRIBUTIONS [T2S.BPD.SETT.SECD]**

6 **5.1.1.1 OVERVIEW**

7 This process describes the act of distributing securities in T2S. In a securities distribution, the proceeds of the
8 CA consist of securities. Stock dividends and bonus issues are typical examples of such events.

9 This section covers the standard steps in a securities distribution within the context of a CSD. It covers both
10 the domestic and the cross-CSD environment.

11 The processes described are in line with the CAJWG and T2S CA standards.

12 **Trigger:**

13 The CSD receives securities distribution event details from relevant entity⁶⁴

14 **Preconditions:**

15 None

16 **T2S Instructing Party:**

17 CSD

⁶⁴ Depending on the operational process of the CSD, the entity can be e.g. Issuer, Issuer's agent, Issuer CSD or other information providers.

1 **5.1.1.2 BUSINESS PROCESS DIAGRAM**

2 **Figure 5-1: Business Process Diagram [T2S.BPD.SETT.SECD]**

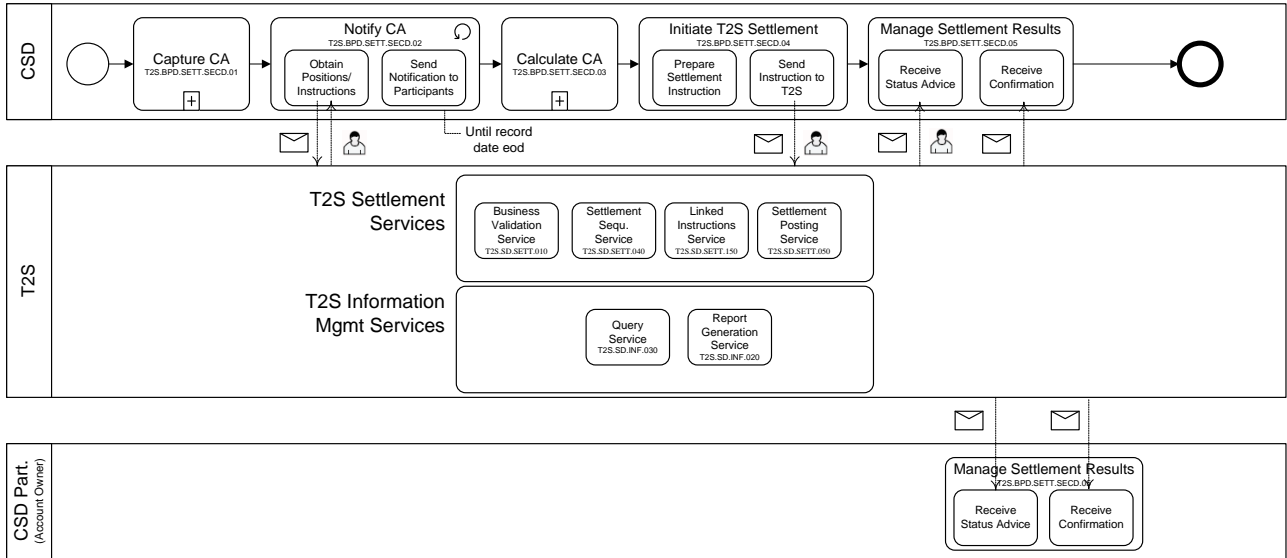

3

4 **5.1.1.3 BUSINESS PROCESS DESCRIPTION**

5 **5.1.1.3.1 Capture CA**

Reference ID	T2S.BPD.SETT.SECD.01
--------------	----------------------

6 T2S Actors: CSD

7 The CSD captures the securities distribution details (CA announcement) that the CSD receives from relevant
8 entity.

9 **5.1.1.3.2 Notify CA**

Reference ID	T2S.BPD.SETT.SECD.02
--------------	----------------------

10 T2S Actors: CSD

11 The CSD identifies the eligible recipients based on the CA details and the T2S information. This process
12 runs until the record date of the CA event for identifying:

- 13 • participants obtaining a new holding in the underlying security after the announcement but before the
14 record date,

- 1 • participants creating a new open position (pending instructions)⁶⁵ in the underlying security after the
2 initial announcement.

3 This sub-process is executed as long as the current date is on or before the CA record date.

4 Apart from the capture of a CA, this sub-process is also triggered by the amendment and cancellation of a
5 CA.

6 References:

7 UDFS: Use Cases “Send Query” (Chapter 2.18) and “Receive Report” (Chapter 2.19)

8 GUI BFD: T2S.GUI.SESE.INX.0070

9 **5.1.1.3.3 Obtain Positions and Pending Instructions**

Reference ID	T2S.BPD.SETT.SECD.02.01
--------------	-------------------------

10 This CSD obtains the securities positions and pending settlement instructions on the underlying ISIN of the
11 CA.

12 The CSD has three options for receiving T2S information:

- 13 • option 1: the CSD receives these details through predefined reports generated by T2S at close of business
14 of settlement day (End of Day reporting), and/or
- 15 • option 2: the CSD queries T2S by specifying the underlying ISIN as a filter criterion,
- 16 • option 3: the CSD receives real-time status advices (specifying the acceptance of settlement instruction
17 in T2S) and confirmation messages (after the settlement of instructions) from T2S.

18 In option 1:

- 19 • based on its report subscription set up in T2S, the CSD receives reports for example:
- 20 ○ Statement of Holdings – This report includes details of all securities positions of all ISINs held in the
21 respective CSD securities accounts.
- 22 ○ Delta statement of holdings – This report includes changes in the quantity of securities positions, i.e.
23 the net quantity which has been debited or credited on the reported positions since the creation of the
24 previous Statement of Holdings.
- 25 ○ Statement of Pending Instructions - This report includes details of all pending instructions related to
26 the respective CSD’s securities accounts, that T2S has accepted.

⁶⁵ These are settlement instructions which do not have a status with value “settled” or “cancelled”. In a typical DVP/FOP transaction, two pending and matched instructions refer to one pending transaction.

- 1 ○ Delta Statement of Pending Instructions - The report lists instructions created/amended since the
- 2 creation of the previous Statement of pending instructions. This report covers:
- 3
 - 4 ▪ new pending settlement instructions,
 - 5 ▪ pending settlement instructions which were modified,
 - 6 ▪ settlement instructions which were formerly pending but are now cancelled,
 - 7 ▪ settlement instructions which are partially settled.
- 7 ● The CSD filters the reports in order to extract details relevant to the underlying ISIN.

8 In option 2:

- 9 ● the CSD queries T2S for securities positions related to the underlying ISIN,
- 10 ● the CSD queries T2S for pending settlement instructions related to the underlying ISIN⁶⁶.

11 In the cross-CSD scenario, both the issuer and the investor CSDs will perform this activity of obtaining
 12 securities positions and pending settlement instructions from T2S.

13 The CSD sends and receives the following messages to/from T2S:

14 **Table 5-1: Messages to and from T2S [T2S.BPD.SETT.SECD.02.01]**

Message Name	ISO Code	To/From T2S	Event	UDFS Chapter
Securities Account Position (History) Query	semt.025.001.01	To T2S	-	3.3.7.11
SecuritiesSettlementTransactionQuery	semt.026.001.01	To T2S	-	3.3.7.12
SecuritiesStatusOrStatementQueryStatusAdviceV03	sese.022.001.03	From T2S	Query instruction is processed in T2S	3.3.8.3
SecuritiesSettlementTransactionQueryResponseV01	semt.027.001.01	From T2S	T2S prepares the response data	3.3.7.13
SecuritiesTransactionPendingReport	semt.018.001.03	From T2S	Time/event based	3.3.7.7
SecuritiesBalanceCustodyReport	semt.002.001.05	From T2S	Time/event based	3.3.7.1

⁶⁶ See section on T2S Services Description for details about T2S Report Generation Services and T2S Query Services

1 **5.1.1.3.4 Send Notifications to Participants**

Reference ID	T2S.BPD.SETT.SECD.02.02
--------------	-------------------------

2 The CSD identifies and informs eligible recipients (received/queried in the previous activity Obtain
3 Positions/pending instructions) about the CA details.

4 **5.1.1.3.5 Calculate CA**

Reference ID	T2S.BPD.SETT.SECD.03
--------------	----------------------

5 T2S Actors: CSD

6 In certain registered markets, the T2S Actor can also be an issuer’s agent (as a CSD Participant).

7 The CSD calculates the CA entitlements based on the securities positions held at the close of business of the
8 record date and based on the CA details.

9 The CSD will handle the CA entitlements on the pending settlement instructions as market claims.

10 For details on market claims, refer to process “Market Claims [T2S.BPD.SETT.MCLA]”.

11 **5.1.1.3.6 Initiate T2S Settlement**

Reference ID	T2S.BPD.SETT.SECD.04
--------------	----------------------

12 T2S Actors: CSD

13 Precondition: Necessary securities proceeds are available to the CSD

14 The CSD initiates the settlement instructions to T2S for distributing securities⁶⁷ entitlements to its
15 participants.

16 References:

17 UDFS: Use Case “Send Settlement Instruction” (Chapter 2.3)

18 GUI BFD: T2S.GUI.SESE.INX.0070

19 **5.1.1.3.7 Prepare Instruction**

Reference ID	T2S.BPD.SETT.SECD.04.01
--------------	-------------------------

20 Prior⁶⁸ to the start of the business (Night-Time Settlement sequence 1) on Payment Date, the CSD creates the
21 settlement instructions for distributing the securities to the entitled position holders.

⁶⁷ In case the outturn ISIN is not eligible in T2S, the distribution of proceeds will be handled outside T2S(applicable for all types of CAs)

1 The CSD could send to T2S, “already matched” settlement instructions. The indicative instruction type (from
 2 the CSD’s perspective) is the following:

3 **Table 5-2: Instruction for Securities Distribution [T2S.BPD.SETT.SECD.04.01]**

Proceeds type	Instruction Type	ISIN	Quantity	Amount
Securities	DFP	Outturn ISIN	Securities proceeds of the participant	Zero

4 **5.1.1.3.8 Send Instruction to T2S**

Reference ID	T2S.BPD.SETT.SECD.04.02
--------------	-------------------------

5 In general, by the start of business on the payment date (prior to Night-Time Settlement sequence 1) the CSD
 6 sends the settlement instructions to T2S.

7 In a CSD link arrangement, both the Issuer CSD and the investor CSD perform this process in order to
 8 generate entitlements for their participants:

- 9 • The Issuer CSD sends to T2S settlement instructions for issuance and distribution of additional
 10 underlying securities. Depending on the Issuer CSD’s account structures, securities are typically created
 11 by the usage of an Issuance and a Distribution (or “off-set”) account. The Distribution account is debited
 12 and participants’ accounts are credited (steps 1 and 2 in Figure 5-2).
- 13 • The investor CSD being a participant of the Issuer CSD receives the proceeds of the securities
 14 distribution in its omnibus account in the Issuer CSD. In its turn, the investor CSD should ensure that
 15 these proceeds are distributed within its own books to the securities accounts of its own participants (step
 16 3 in Figure 5-2).

17 The CSD has the possibility to send all settlement instructions related to a specific securities distribution
 18 event to settle on an “All-or-none” basis.

19 The CSD also has the option to send the securities issuance and all the securities distribution settlement
 20 instructions related to a specific CA, to settle on an “All or none” basis.

⁶⁸ In case CSD is not able to send CA related instructions to T2S prior to NTS sequence 1, CSD could block the underlying ISIN for settlement purpose except for CA instructions. Once the CA instructions are settled, CSD could unblock the underlying ISIN to allow trade related settlements. Refer fifth example in section 1.2.1.8 Restriction types of UDFS 1.2,

1 **Figure 5-2: Securities Distribution in the context of T2S [T2S.BPD.SETT.SECD.04.02]**

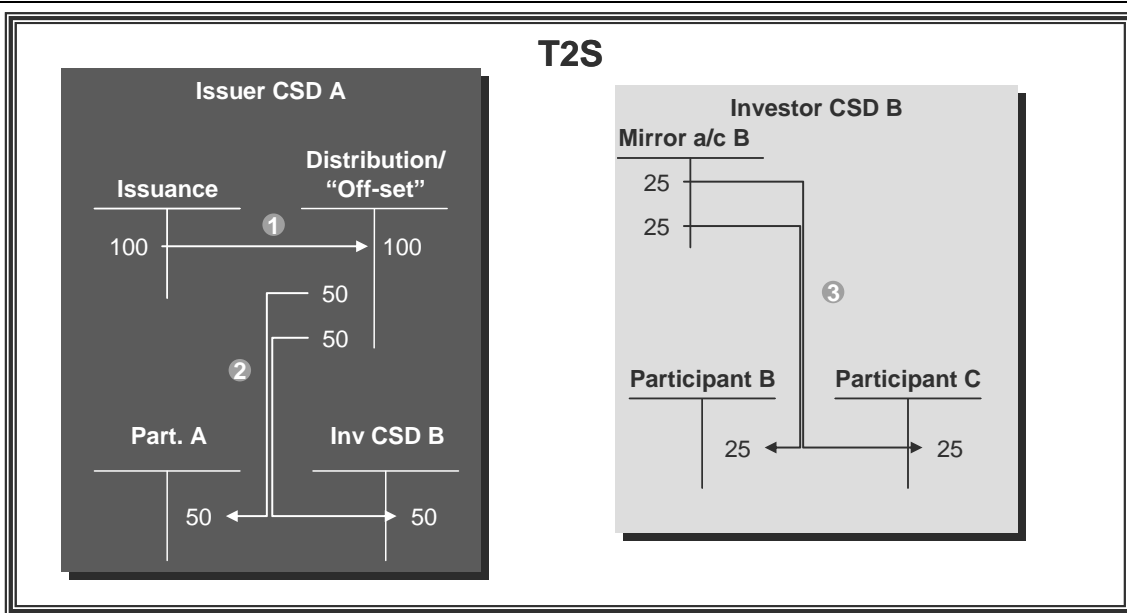

2
 3 Step 1: The Issuer CSD A initiates the issuance process of a 100 securities distribution. The procedure
 4 resembles a “primary market” operation. Securities are created by the usage of an Issuance and a Distribution
 5 (or “off-set”) account.

6 Step 2: The Issuer CSD A distributes the securities entitlements to its own participants. The distribution
 7 account is debited and participants’ accounts are credited accordingly. In case the instructions are linked as
 8 ”all or none”, the 2 transactions (i.e. move positions from distribution account to participant A’s account &
 9 move positions from distribution account to investor CSD B’s account) are done simultaneously, and could
 10 be in any sequence. Investor CSD B does not differ from a standard CSD A participant. Investor CSD B
 11 receives in its omnibus account in the CSD A, the proceeds of the securities distribution (50).

12 Step 3: Investor CSD B distributes the securities entitlements to the two relevant participants (25 each).
 13 Mirror account is debited and investor CSD B participants’ accounts are credited accordingly.

14 In T2S, as in cross-CSD CA processing today, movements 2 and 3 are not dependant upon the checking of a
 15 central mechanism. Investor CSD B like any other participant of Issuer CSD A, may or may not wait for the
 16 final settlement of movement 2 before initiate movement 3 in its own books. Movement 2 is not a
 17 prerequisite of movement 3.

18 The CSD sends the following message to T2S:

19

1 **Table 5-3: Messages to T2S [T2S.BPD.SETT.SECD.04.02]**

Message Name	ISO Code	To/From T2S	UDFS Chapter
SecuritiesSettlementTransactionInstruction	Sese.023.001.03	To T2S	3.3.8.4

2 **5.1.1.3.9 T2S Processing**

3 For details on the T2S services involved in the settlement of the instruction, refer to process “Intra-CSD
4 Settlement [T2S.BPD.SETT.ICSD]”.

5 For details on the T2S services involved in obtaining positions, refer to processes “Reports
6 [T2S.BPD.INFO.REPT]”and “Queries [T2S.BPD.INFO.QUIRE]”.

7 **5.1.1.3.10 Manage Settlement Results**

Reference ID	T2S.BPD.SETT.SECD.05
--------------	----------------------

8 T2S Actors: CSD and CSD Participant

9 The CSD and CSD Participant receive the settlement related messages from T2S and initiate related internal
10 processes.

11 References:

12 UDFS: Use Case “Send Settlement Instruction” (Chapter 2.3)

13 **5.1.1.3.11 Receive Status Advice**

Reference ID	T2S.BPD.SETT.SECD.05.01
--------------	-------------------------

14 This CSD and CSD Participant receive status advice messages for every change of status or update of reason
15 code to the settlement instruction within T2S.

16 The CSD and CSD Participant receive the following message from T2S:

17 **Table 5-4: Messages from T2S [T2S.BPD.SETT.SECD.05.01]**

Message Name	ISO Code	To/From T2S	Event	UDFS Chapter
SecuritiesSettlementTransactionStatusAdvice	Sese.024.001.03	From T2S	T2S changes status of settlement instruction	3.3.8.5

18 **5.1.1.3.12 Receive Settlement Confirmation**

Reference ID	T2S.BPD.SETT.SECD.05.02
--------------	-------------------------

1 The CSD and CSD Participant receive the settlement confirmation messages from T2S for the settlement
 2 instructions that the CSD sent to T2S.

3 The CSD and CSD Participant receive the following message from T2S:

4 **Table 5-5: Messages from T2S [T2S.BPD.SETT.SECD.05.02]**

Message Name	ISO Code	To/From T2S	Event	UDFS Chapter
SecuritiesSettlementTransactionConfirmationV03	Sese.025.001.03	From T2S	T2S settles the settlement instruction	3.3.8.6

5

1 **5.1.2 CASH DISTRIBUTIONS [T2S.BPD.SETT.CSHD]**

2 **5.1.2.1 OVERVIEW**

3 This process describes the act of distributing cash in T2S. In cash distributions, the proceeds of the CA
4 consist only of cash. Capital gains, cash dividends, interest payments and share premium dividends are
5 typical examples of such events. This section covers the standard steps in a cash distribution within the
6 context of a CSD⁶⁹. It covers both the domestic and the cross CSD scenarios.

7 The processes described are in line with the CAJWG and T2S CA standards.

8 This process is a variation of the process “Securities Distribution [T2S.BPD.SETT.SECD]”. The steps
9 highlighted in the diagram below require particular attention.

10 **Trigger:**

11 CSD receives cash distribution event details from relevant entity.

12 **Preconditions:**

13 None

14 **T2S Instructing Party:**

15 CSD

⁶⁹ ‘CSD’ refers to both Issuer CSD and investor CSD, unless specifically mentioned otherwise.

1 **5.1.2.2 BUSINESS PROCESS DIAGRAM**

2 **Figure 5-3: Business Process Diagram [T2S.BPD.SETT.CSHD]**

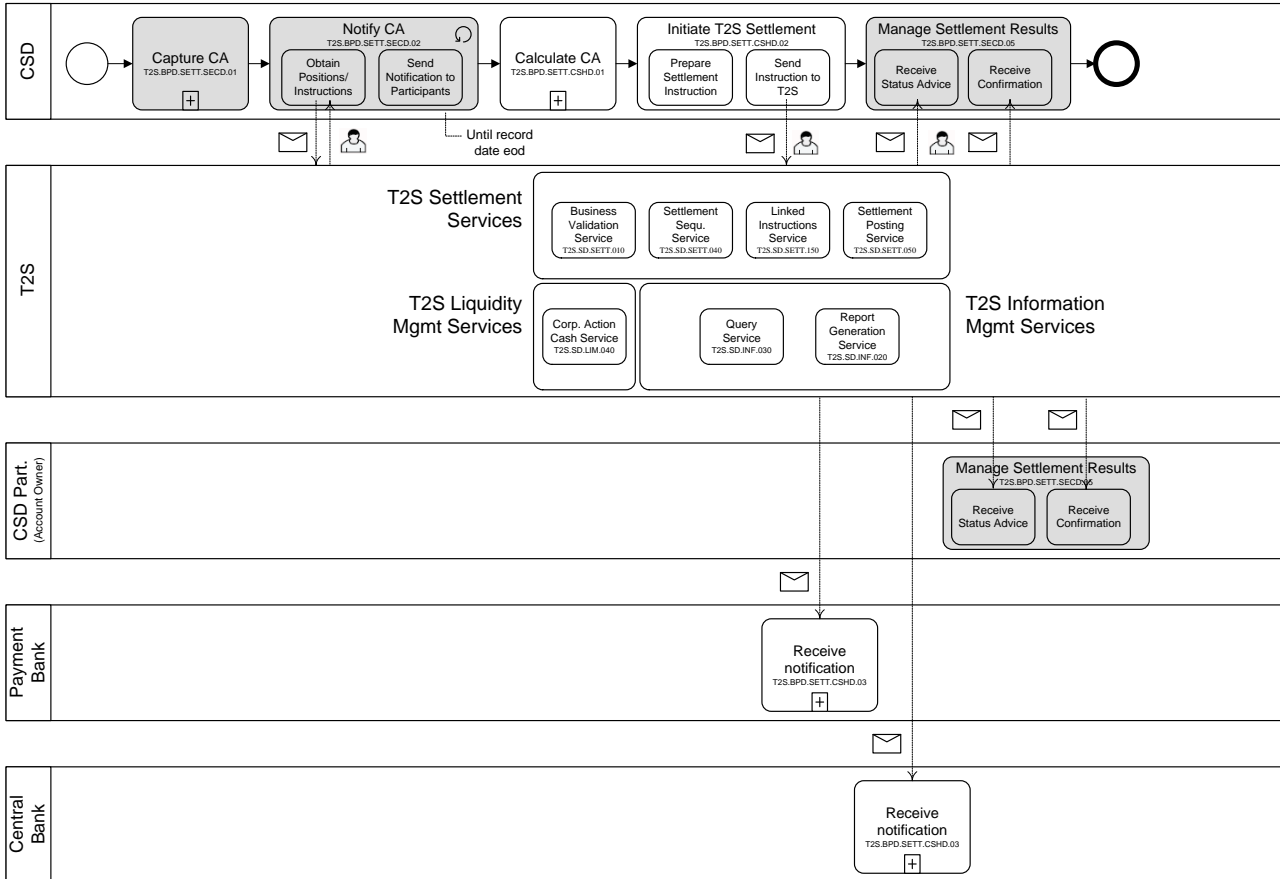

3

4 **5.1.2.3 BUSINESS PROCESS DESCRIPTION**

5 **5.1.2.3.1 Calculate CA**

Reference ID	T2S.BPD.SETT.CSHD.01
--------------	----------------------

6 T2S Actors: CSD

7 In certain registered markets, the T2S Actor can also be an issuer’s agent (as a CSD Participant).

8 The CSD calculates the CA entitlements based on securities positions at the close of business of the CA
 9 record date and based on the CA details. The CSD will handle the CA entitlements on the pending settlement
 10 instructions as market claims.

11 For details on market claims, refer to process “Market Claims [T2S.BPD.SETT.MCLA]”.

12

1 **5.1.2.3.2 Initiate T2S Settlement**

Reference ID	T2S.BPD.SETT.CSHD.02
--------------	----------------------

2 T2S Actors: CSD

3 In certain registered markets, the T2S Actors can also be an issuer’s agent (as a CSD Participant).

4 Precondition: Necessary cash proceeds are available to the CSD or issuer’s agent.

5 The CSD initiates the settlement instructions to T2S for distributing cash entitlements to the CSD
6 Participants.

7 References:

8 UDFS: Use Case “Send Settlement Instruction” (Chapter 2.3)

9 GUI BFD: T2S.GUI.SESE.INX.0070

10 **5.1.2.3.3 Prepare Instruction**

Reference ID	T2S.BPD.SETT.CSHD.02.01
--------------	-------------------------

11 This CSD creates the settlement instruction for distributing the cash to the entitled position holders.

12 In certain registered markets, the T2S Actors can also be an issuer’s agent (as a CSD Participant).

13 As per the CAJWG and T2S CA standard, cash payments resulting from corporate action events should be
14 paid via the same “payment mechanism” as any standard DVP activity (i.e. T2S dedicated cash accounts -
15 DCA).⁷⁰

16 At the latest by the start of business on the payment date (prior to Night-Time Settlement sequence 1), the
17 CSD sends to T2S the settlement instructions for crediting the cash to the entitled position holders.

18 The CSD sends to T2S, “already matched” payment free of delivery settlement instructions (PFOD). The
19 indicative instruction type (from CSD’s/issuer/issuer’s agent perspective) is the following:

20 **Table 5-6: Settlement Instruction Types for Cash Distribution [T2S.BPD.SETT.CSHD.02.01]**

Proceeds type	Instruction Type	ISIN	Quantity	Amount
Cash	DVP	Underlying ISIN	Zero	Cash proceeds

21 Typically, a matched PFOD consists of the following two legs:

- 22 • RVP instruction for delivery of cash

⁷⁰ In case of currencies not eligible in T2S, cash payments will take place outside T2S

- 1 • DVP instruction for receipt of cash
- 2 The instructions should contain the following information (non-exhaustive list of details):
- 3 • the DCA of the CSD or any other T2S party distributing the cash proceeds,
- 4 • the DCA⁷¹ of the CSD Participant (receiving the cash proceeds),
- 5 • the Securities account⁷² of the CSD or the T2S party distributing the cash proceeds,
- 6 • the Securities account of the CSD Participant which receives the cash proceeds,
- 7 • the underlying securities (i.e. ISIN),
- 8 • the (securities) settlement quantity as zero,
- 9 • the cash amount.

10 **5.1.2.3.4 Send Instruction to T2S**

Reference ID	T2S.BPD.SETT.CSHD.02.02
--------------	-------------------------

11 At the latest by the start of business on the payment date⁷³ (prior to Night-Time Settlement sequence 1) the
 12 CSD sends the settlement instructions to T2S.

13 In a CSD link arrangement (cross-CSD settlement) both the Issuer CSD and the investor CSD will perform
 14 this process in order to generate the cash entitlements for their respective CSD Participants.

- 15 • For distribution of cash to its participants, the Issuer CSD sends settlement instructions to T2S. T2S
 16 debits the dedicated cash account of the issuer/issuer’s agent and credits the CSD Participants’ cash
 17 accounts (step 1 in [Figure 5-4](#)Figure 5-4).
- 18 • The investor CSD being a participant of the Issuer CSD receives the cash proceeds in its DCA. In turn,
 19 the investor CSD should ensure that these proceeds are distributed within its own books to the DCAs of
 20 its own participants (step 2 in [Figure 5-4](#)Figure 5-4).

21 The CSD has the possibility to send all cash-distribution settlement instructions to settle on an “All or none”
 22 basis in T2S.

⁷¹ If DCA is not specified in the settlement instruction, T2S will use the default DCA linked to the securities account.
⁷² As per ISO 20022, the delivering or receiving securities account is a mandatory field in the settlement instruction
⁷³ In case CSD is not able to send CA related instructions to T2S prior to NTS sequence 1, CSD could block the underlying ISIN for settlement purpose except for CA instructions. Once the CA instructions are settled, CSD could unblock the underlying ISIN to allow trade related settlements. Refer fifth example in section 1.2.1.8 Restriction types of UDFS 1.2,

1 **Figure 5-4: Cash Distribution in the context of T2S [T2S.BPD.SETT.CSHD.02.02]**

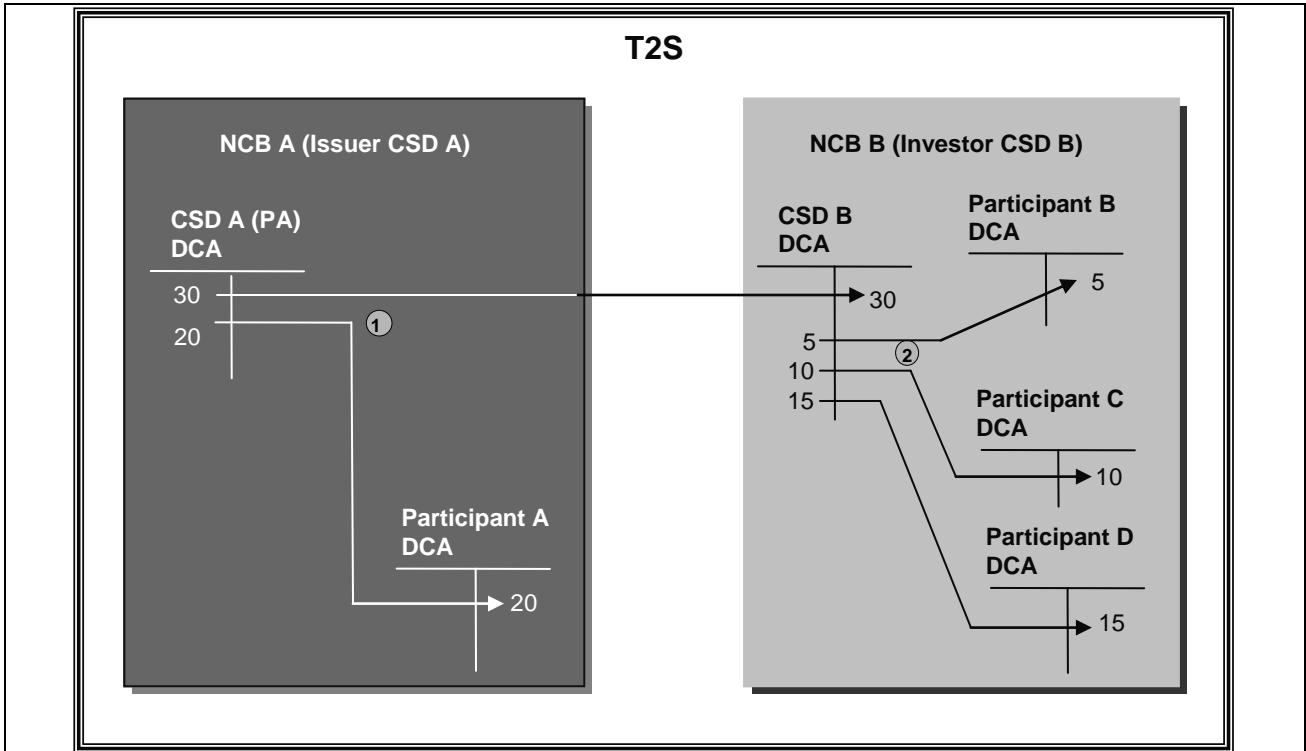

2
3 Step 1: An issuer’s agent A (or the CSD A itself) is responsible for distributing the cash entitlements in the
4 environment of the Issuer CSD A. The CSD A’s/Payment Agent’s DCA is debited and participants’ accounts
5 are credited. In case the instructions are linked as “all or none”, the 2 transactions (i.e. move cash from CSD
6 A’s/Payment Agent’s DCA to CSD B’s DCA & move cash from CSD A’s/Payment Agent’s DCA to
7 participant A’s DCA) are done simultaneously, and could be in any sequence. The investor CSD B may be
8 using a settlement bank (SB) for managing its liquidity (SB receives EUR30 for investor CSD B).

9 Step 2: The investor CSD B has received EUR 30 in its DCA operated by its SB. Cash distributions in the
10 form of cash payments are made towards the participants (B, C and D) of investor CSD B (movement 2)

11 The CSD sends the following message to T2S:

12 **Table 5-7: Messages to T2S [T2S.BPD.SETT.CSHD.02.02]**

Message Name	ISO Code	To/From T2S	UDFS Chapter
SecuritiesSettlementTransactionInstruction	Sese.023.001.03	To T2S	3.3.8.4

13

1 **5.1.2.3.5 T2S Processing**

2 The **Corporate Action Cash Service (T2S.SD.LIM.040)** facilitates the creation of a standing instruction to
 3 specify whether the liquidity received should stay in the T2S DCA or be moved to an RTGS account outside
 4 T2S and executes the instruction by creating an immediate liquidity transfer order.

5 For details on the remaining T2S services involved in the settlement of the instruction, refer to process
 6 “Intra-CSD Settlement [T2S.BPD.SETT.ICSD]”.

7 For details on the T2S services involved in obtaining positions, refer to processes “Reports
 8 [T2S.BPD.INFO.REPT]”and “Queries [T2S.BPD.INFO.QURE]”.

9 **5.1.2.3.6 Receive and Manage Notification**

Reference ID	T2S.BPD.SETT.CSHD.03
--------------	----------------------

10 T2S Actors: Central Bank and Payment Bank

11 The Central Bank and Payment Bank receive the posting notifications from T2S, when the cash amount is
 12 credited/debited from the DCA owned by the Central Bank/Payment Bank.

13 If the CSD Participant’s Payment Bank has set up a standing instruction to move cash proceeds to an RTGS
 14 account (outside T2S), T2S will create an immediate liquidity transfer.

15 The relevant Central Bank and Payment Bank will receive the status advices for this liquidity transfer.

16 The Central Bank and Payment Bank receive the following messages from T2S:

17 **Table 5-8: Messages from T2S [T2S.BPD.SETT.CSHD.03]**

Message Name	ISO Code	To/From T2S	Event	UDFS Chapter
BankToCustomerDebitCreditNotificationV03	camt.054.001.03	From T2S	T2S debits cash amount into DCA, T2S credits cash amount into DCA	3.3.3.17
LiquidityCreditTransfer	camt.050.001.03	From T2S	T2S completes posting of cash into DCA	3.3.3.13

18

1 **5.1.3 DISTRIBUTION WITH OPTIONS [T2S.BPD.SETT.CHOS]**

2 Distributions with options are distribution events which provide the investor with a choice of proceeds. An
3 example of such an event is an optional dividend (e.g. with options for receiving cash and/or securities).

4 According to the CAJWG standards, the CSD should treat distributions with options as two separate CA
5 events:

- 6 • the distribution of the interim ISIN,
- 7 • the mandatory reorganisation with option event (i.e. the option) on the interim ISIN.

8 For details on the first event (Securities Distribution), refer to process “Securities Distribution
9 [T2S.BPD.SETT.SECD]”.

10 For details on the second event (Mandatory Reorganisations with Options), refer to process “Mandatory
11 Reorganisation with Options [T2S.BPD.SETT.RGOP]”.

12

1 **5.2 REORGANISATIONS**

2 A reorganisation is a CA event whereby the underlying security is replaced with proceeds.

3 **5.2.1 MANDATORY REORGANISATIONS [T2S.BP.SETT.MAND]**

4 **5.2.1.1 OVERVIEW**

5 This process describes the act of undertaking a mandatory reorganisation in T2S. Mandatory reorganisation
6 is a reorganisation that affects in all cases the underlying security (e.g. stock split, redemption). This process
7 replaces the underlying securities fully or partly with one or more resources (cash only, securities only, both
8 cash and securities).

9 The processes described are in line with the CAJWG and T2S CA standards.

10 This process is a variation of the process “Securities Distribution [T2S.BPD.SETT.SECD]”. The steps
11 highlighted in the diagram below require particular attention.

12 **Trigger:**

13 The CSD receives the mandatory reorganisations event details from relevant entity.

14 **Preconditions:**

15 None

16 **T2S Instructing Party:**

17 CSD

1 **5.2.1.2 BUSINESS PROCESS DIAGRAM**

2 **Figure 5-5: Business Process Diagram [T2S.BP.SETT.MAND]**

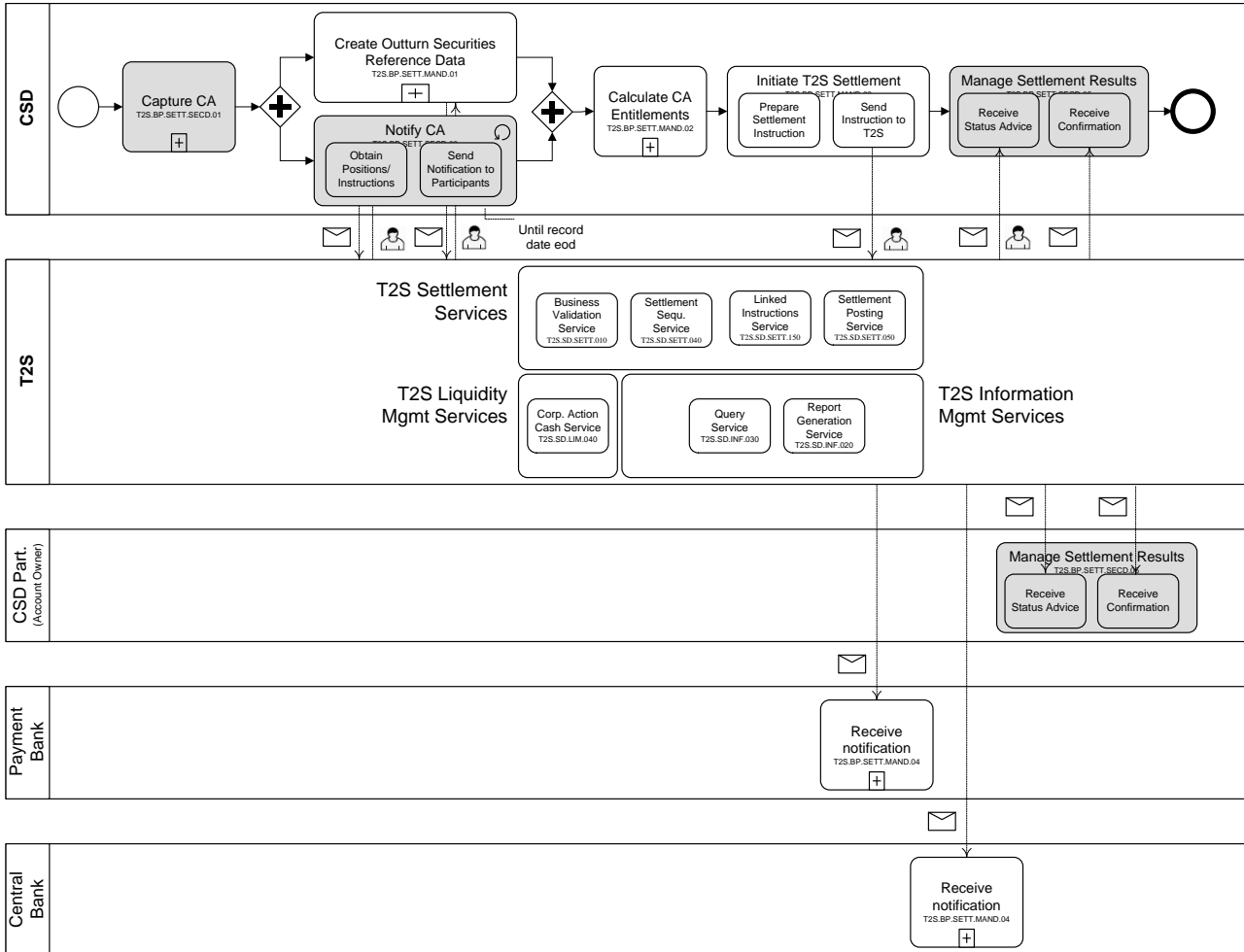

3

4 **5.2.1.3 BUSINESS PROCESS DESCRIPTION**

5 **5.2.1.3.1 Create Outturn Securities Reference Data**

Reference ID	T2S.BP.SETT.MAND.01
--------------	---------------------

6 T2S Actors: CSD

7 Precondition: Availability of the ISIN code of the outturn securities

8 The CSD initiates the creation of new outturn securities in T2S, if the mandatory reorganisation involves
 9 distribution of securities⁷⁴.

⁷⁴ According to CAJWG standard 16 of mandatory reorganisation, a new ISIN should be allocated to each outturn securities

1 For details on the creation of securities static data, refer to process “Maintenance of Securities
2 [T2S.BPD.STDA.MSEC]”.

3 **5.2.1.3.2 Calculate CA Entitlements**

Reference ID	T2S.BP.SETT.MAND.02
--------------	---------------------

4 T2S Actors: CSD

5 This process is triggered once the CSD receives information on final holdings in the underlying ISIN.

6 The CSD calculates the CA entitlements based on the securities positions held at the close of business of the
7 record date and based on the CA details.

8 This sub-process is executed as long as the current date is on or before the CA record date.

9 **5.2.1.3.3 Initiate T2S Settlement**

Reference ID	T2S.BP.SETT.MAND.03
--------------	---------------------

10 T2S Actors: CSD

11 Precondition: Necessary CA proceeds are available to the CSD

12 The CSD initiates the settlement instructions to T2S for CA reorganisations. This process involves the
13 creation of the settlement instructions necessary for the removal of underlying securities and credit of outturn
14 securities and/or cash, depending upon the CA reorganisation event details.

15 The CSD will handle the re-organisations on the pending settlement transactions as transformations. For
16 details on transformations, refer to process “Transformations [T2S.BPD.SETT.TRAN]”.

17 References:

18 UDFS: Use Case “Send Settlement Instruction” (Chapter 2.3)

19 GUI BFD: T2S.GUI.SESE.INX.0070

20 **5.2.1.3.4 Prepare Instruction**

Reference ID	T2S.BP.SETT.MAND.03.01
--------------	------------------------

21 The CSD creates the settlement instruction for removal⁷⁵ of underlying securities and the crediting of outturn
22 securities and /or cash to the entitled position holders.

⁷⁵ If payment date is not record date + 1 business day, CSD instructs debit of underlying securities, credit of outturn securities on different dates, to T2S

1 The CSD creates “already matched” instructions. The indicative instruction type (from
 2 CSD’s/issuer’s/issuer’s agent’s perspective) for each type of CA proceeds is as below

3 **Table 5-9: Settlement Instruction Types for Mandatory Reorganisation [T2S.BP.SETT.MAND.03.01]**

Proceeds type	Instruction Type	ISIN	Quantity	Amount
Cash only	RVP	Underlying ISIN	Securities positions of the participant	Cash proceeds of the participant
Securities only	RFP	Underlying ISIN	Securities positions of the participant	-
	DFP	Outturn ISIN	Securities proceeds for the participant	-
Cash and securities	RVP	Underlying ISIN,	Securities positions of the participant	Cash proceeds of the participant
	DFP	Outturn ISIN	Securities proceeds for the participant	-

4 The CSD can optionally create all Reorganisation CA settlement instructions to settle on an “All or none”
 5 basis.

6 **5.2.1.3.5 Send Instruction to T2S**

Reference ID	T2S.BP.SETT.MAND.03.02
--------------	------------------------

7 By the start of business on the payment date⁷⁶ (before the T2S night time settlement sequence 1) the CSD
 8 sends the settlement instructions to T2S.

9 *CA reorganisation in a Cross CSD environment*

10 In a cross-CSD environment wherein the CSDs are linked to each other, both the Issuer CSD and the investor
 11 CSD perform this process in order to generate reorganisations for their respective CSD Participants.

12 The Issuer CSD sends to T2S settlement instructions either for the removal of the underlying securities, the
 13 issuance and distribution of outturn securities and/or credit of cash. Based on the market specific operational
 14 procedures, the Issuer CSD may define an account structure consisting of both an Issuance and a Distribution
 15 (or “off-set”) account for creation and removal of securities.

- 16 • For issuance, the Issuer CSD instructs debit of Issuance account and credit of Distribution account. For
 17 distribution of CA proceeds, Issuer CSD instructs debit of Distribution account and credit of

⁷⁶ In case CSD is not able to send CA related instructions to T2S prior to NTS sequence 1, CSD could block the underlying ISIN for settlement purpose except for CA instructions. Once the CA instructions are settled, CSD could unblock the underlying ISIN to allow trade related settlements. Refer fifth example in section 1.2.1.8 Restriction types of UDFS 1.2,

Participants' accounts ([Figure 5-7: Securities Distribution in the context of T2S \[T2S.BP.SETT.MAND.03.02\]](#)~~Figure 5-7: Securities Distribution in the context of T2S [T2S.BP.SETT.MAND.03.02]~~).

- For removal of underlying securities, the Issuer CSD instructs the debit of Participant's account and credit of Distribution account. Subsequently, Issuer CSD instructs debit of Distribution account and credit of Issuance account. This results in the decrease of issued balance of underlying securities. The securities movements for removal of underlying securities occurs in a direction opposite to issuance of securities.
- For cash credit, the Issuer CSD instructs debit of cash from the T2S dedicated cash account of the Payment Bank managing the payments on behalf of the issuer/issuer's agent. The Issuer CSD instructs the credit of cash to either the default T2S dedicated cash account associated with the relevant securities account or to the T2S dedicated cash account provided by the CSD Participant ([Figure 5-8: Credit of Cash in the context of T2S \[T2S.BP.SETT.MAND.03.02\]](#)~~Figure 5-8: Credit of Cash in the context of T2S [T2S.BP.SETT.MAND.03.02]~~).

The investor CSD being a participant of the Issuer CSD delivers underlying securities and receives the outturn securities proceeds in its omnibus account in the Issuer CSD. In its turn, the investor CSD should ensure that these removals and credit of securities are reflected within its own books on the securities accounts of its own participants and the credit of cash is reflected on the T2S dedicated cash accounts provided by its Participants.

Figure 5-6: Securities Removal in the context of T2S [T2S.BP.SETT.MAND.03.02]

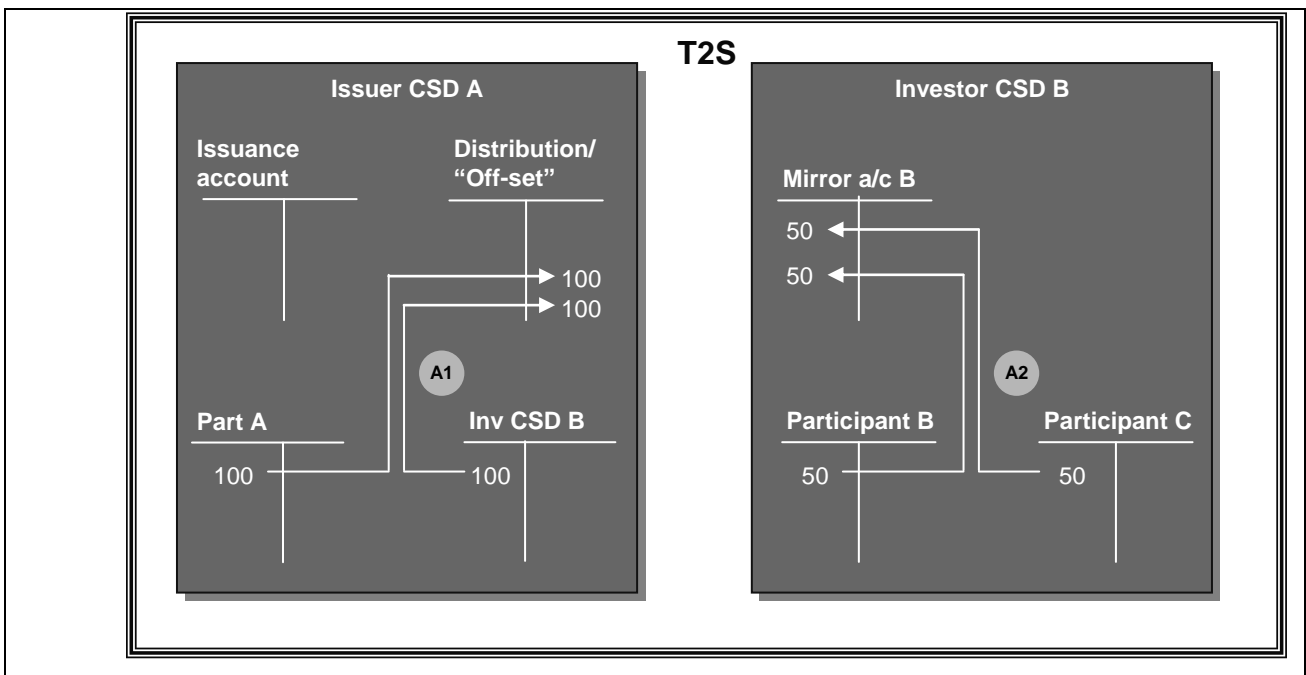

- 1 Step A1: The Issuer CSD A initiates the removal of the positions on underlying ISIN from its participant's
 2 accounts (On SOD of record date +1). Issuer CSD A instructs debit of participant's accounts and credit of
 3 distribution/Off-set account.
- 4 Step A2: The Investor CSD B initiates the removal of the positions on underlying ISIN from its participant's
 5 accounts (On SOD of record date +1). Investor CSD B instructs debit of participant's accounts and credit of
 6 mirror account.
- 7 The steps 1 and 2 could be initiated simultaneously.

8 **Figure 5-7: Securities Distribution in the context of T2S [T2S.BP.SETT.MAND.03.02]**

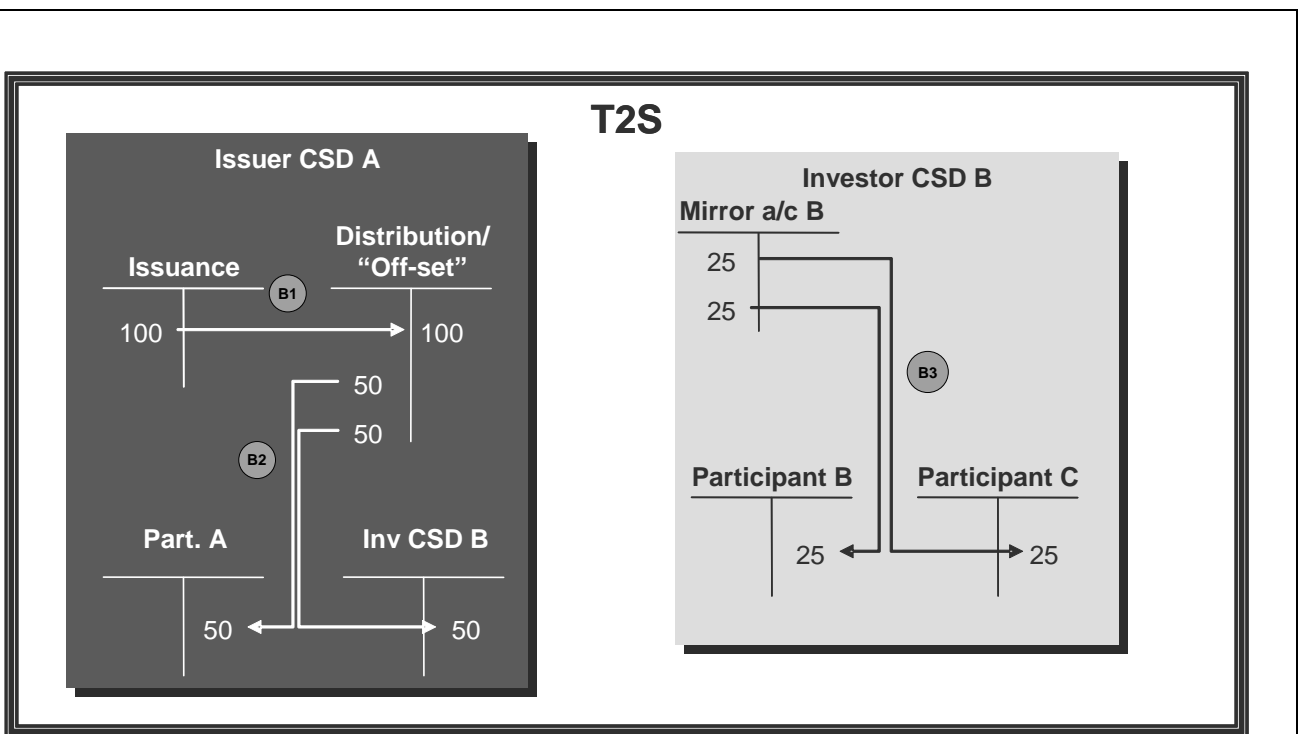

- 10
- 11 Step B1: The Issuer CSD A initiates the issuance process of a 100 securities distribution. The procedure
 12 resembles a "primary market" operation. Issuer CSD creates securities by the usage of an Issuance and a
 13 Distribution (or "off-set") account.
- 14 Step B2: The Issuer CSD A distributes the outturn securities to its own participants. Issuer CSD A instructs
 15 the debit of distribution account and credit of participants' accounts. Investor CSD B does not differ from a
 16 standard CSD A participant. Investor CSD B receives in its omnibus account in the CSD A, the proceeds of
 17 the securities distribution (50 securities).
- 18 Step B3: Investor CSD B distributes the securities entitlements to the two relevant participants (25 securities
 19 each). Investor CSD B instructs debit of Mirror account and credit of investor CSD B participants' accounts.

1 **Figure 5-8: Credit of Cash in the context of T2S [T2S.BP.SETT.MAND.03.02]**

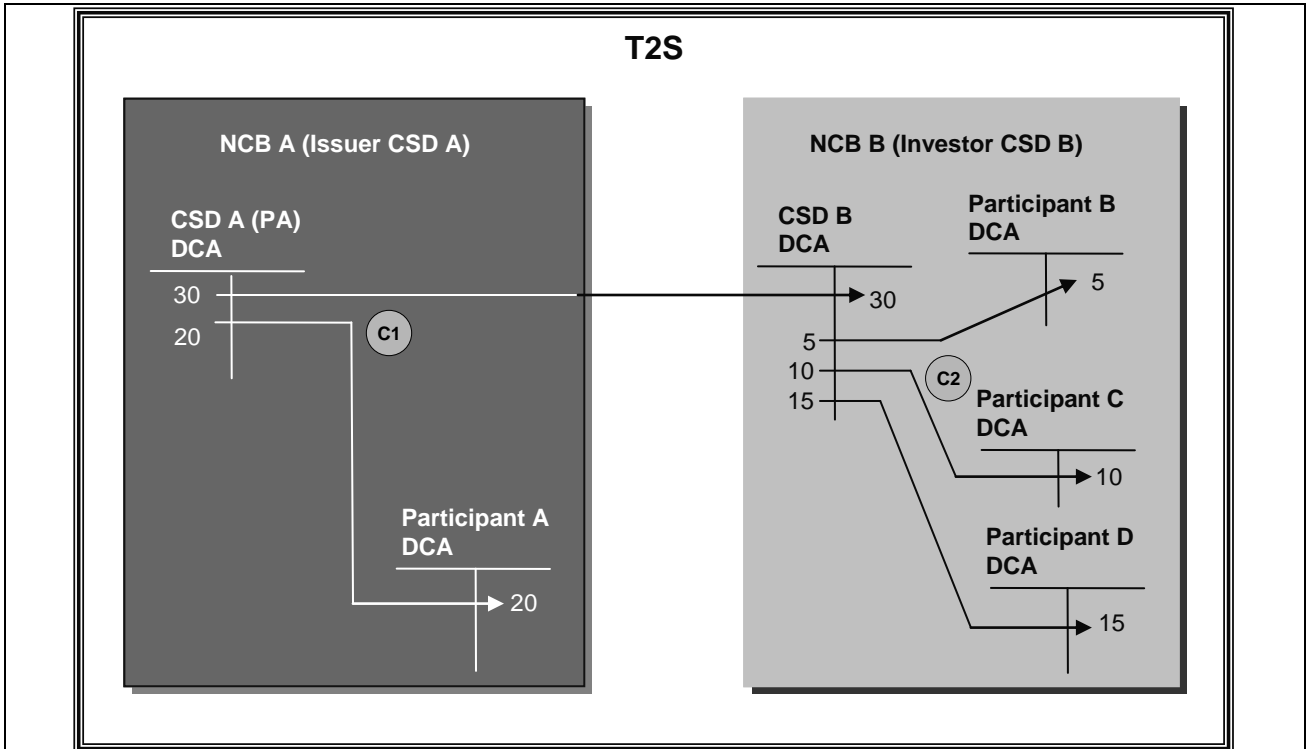

2
3 Step C1: Issuer’s agent A is responsible for distributing the cash entitlements in the environment of the
4 Issuer CSD A. The CSD A’s/Payment Agent’s DCA is debited and participants’ accounts are credited. In
5 case the instructions are linked as “all or none”, the 2 transactions (i.e. move cash from CSD A’s/Payment
6 Agent’s DCA to CSD B’s DCA & move cash from CSD A’s/Payment Agent’s DCA to participant A’s
7 DCA) are done simultaneously, and could be in any sequence. Investor CSD B may be using a settlement
8 bank (SB) for managing its liquidity (SB receives EUR30 for investor CSD B).

9 Step C2: The investor CSD B has received EUR 30 in its DCA operated by its SB. Cash distributions in the
10 form of cash payments are made towards the participants (b, c and d) of investor CSD B (movement 2)

11 The CSD sends the following message to T2S:

12 **Table 5-10: Messages to T2S [T2S.BP.SETT.MAND.03.02]**

Message Name	ISO Code	To/From T2S	UDFS Chapter
SecuritiesSettlementTransactionInstruction	Sese.023.001.03	To T2S	3.3.8.4

13 **5.2.1.3.6 T2S Processing**

14 For details on the T2S services involved in the settlement of the instruction, refer to process “Intra-CSD
15 Settlement [T2S.BPD.SETT.ICSD]”.

1 For details on the T2S services involved in obtaining positions, refer to processes “Reports
2 [T2S.BPD.INFO.REPT]”and “Queries [T2S.BPD.INFO.QUIRE]”.

3 For details on the T2S services involved in the creation of outturn securities reference data, refer to process
4 “Maintenance of Securities [T2S.BPD.STDA.MSEC]”.

5 **5.2.1.3.7 Receive Notification**

Reference ID	T2S.BP.SETT.MAND.04
--------------	---------------------

6 T2S Actors: Central Bank and Payment Bank

7 The Central Bank/Payment Bank receives the posting notifications from T2S, when the entitlement cash
8 amount is credited/debited from the DCA owned by the Central Bank/Payment Bank.

9 If the CSD Participant’s Payment Bank has set up a standing instruction to move cash proceeds to an RTGS
10 account (outside T2S), T2S will create an immediate liquidity transfer. The relevant Central Bank and the
11 Payment bank will receive the status advices for this liquidity transfer.

12 The Central Bank and Payment Bank receive the following messages from T2S:

13 **Table 5-11: Messages from T2S [T2S.BP.SETT.MAND.04]**

Message Name	ISO Code	To/From T2S	Event	UDFS Chapter
BankToCustomerDebitCreditNotificationV03	camt.054.001.03	From T2S	T2S debits cash amount into DCA, T2S credits cash amount into DCA	3.3.3.17
LiquidityCreditTransfer	camt.050.001.03	From T2S	T2S completes posting of cash into DCA	3.3.3.13

14

1 **5.2.2 VOLUNTARY REORGANISATIONS [T2S.BPD.SETT.VOLU]**

2 **5.2.2.1 OVERVIEW**

3 This process describes the act of executing a voluntary reorganisation in T2S. A voluntary reorganisation is a
4 reorganisation event in which participation is optional for the holder of the underlying security.

5 A “tender offer” (an offer made to shareholders, offering them to sell (tender) or exchange their equities) is
6 an example of a voluntary reorganisation event. This section covers the standard steps within the context of a
7 CSD settling the outcome of a voluntary reorganisation in T2S. It covers both the domestic and the cross
8 CSD scenarios.

9 This process is a variation of the process “Mandatory Reorganisations [T2S.BPD.SETT.MAND]”. The steps
10 highlighted in the diagram below require particular attention.

11 **Trigger:**

12 The CSD receives the voluntary reorganisations event details from relevant entity

13 **Preconditions:**

14 None

15 **T2S Instructing Party:**

16 CSD

1 **5.2.2.2 BUSINESS PROCESS DIAGRAM**

2 **Figure 5-9: Business Process Diagram [T2S.BPD.SETT.VOLU]**

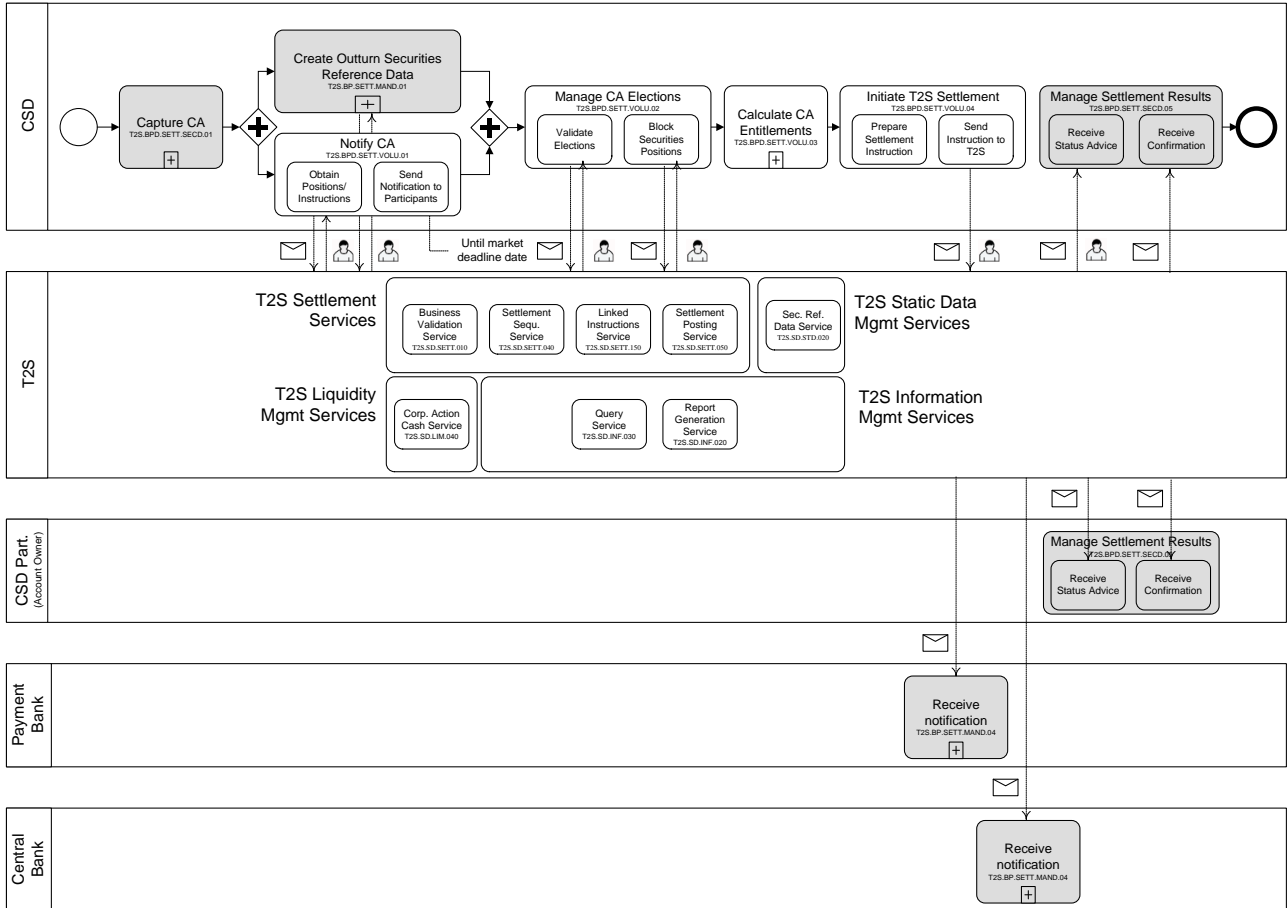

3

4 **5.2.2.3 BUSINESS PROCESS DESCRIPTION**

5 **5.2.2.3.1 Notify CA**

Reference ID	T2S.BPD.SETT.VOLU.01
--------------	----------------------

6 T2S Actors: CSD

7 The CSD identifies the eligible recipients based on the CA details (ISIN, market deadline date etc) and the
 8 T2S information. The CSD informs eligible recipients about the CA details. This process runs until the
 9 market deadline date of the CA event.

10

1 **5.2.2.3.2 Manage CA Elections**

Reference ID	T2S.BPD.SETT.VOLU.02
--------------	----------------------

2 T2S Actors: CSD

3 The CSD receives the CA elections from its participants. The CSD may facilitate CA elections on pending
 4 instructions, if it offers an automated buyer protection service. For details on buyer protection, refer to
 5 process “Buyer Protection [T2S.BPD.SETT.BPRO]”.

6 **5.2.2.3.2.1 Validate CA Elections**

Reference ID	T2S.BPD.SETT.VOLU.02.01
--------------	-------------------------

7 The CSD checks all the details in the CA election against the reference data in its systems and may proceed
 8 to perform additional validations specific to the market practices or national regulations (if any).

9 **5.2.2.3.2.2 Block Securities Positions**

Reference ID	T2S.BPD.SETT.VOLU.02.02
--------------	-------------------------

10 The CSD creates and sends to T2S intra-position movements for moving the elected securities positions from
 11 the “available” securities position type to the “blocked for CA⁷⁷” securities position type, in the participant’s
 12 account.

13 For details on the blocking of a securities position, refer to process “Reservation or Blocking of Securities
 14 Position [T2S.BPD.SETT.RBSP]”.

15 Depending on the way a specific CA is processed, the CSD may alternatively send settlement instructions to
 16 T2S for moving elected securities positions⁷⁸ from CSD Participant’s securities account to Issuer/Issuer’s
 17 agent’s securities account.

18 In a cross-CSD environment, the investor CSD communicates the CA elections to the Issuer CSD/
 19 Issuer/Issuer’s agent after successful blocking of the elected securities positions.

20

⁷⁷ ‘Blocked for CA’ is a securities position type created by the respective CSD to manage certain reorganisations. CSD will have to create all their securities position types using the T2S settlement restrictions model.

⁷⁸ In case of election withdrawal by participants, the CSD could initiate unblocking of securities positions or movement of securities positions from issuer/ issuer’s agent’s account to participant account

1 **5.2.2.3.3 Receive Calculated CA Entitlements**

Reference ID	T2S.BPD.SETT.VOLU.03
--------------	----------------------

2 T2S Actors: CSD

3 When the payment date is reached, the Issuer/ Issuer’s agent calculates the entitlements based on the
 4 securities positions that have been segregated accounting-wise and the related instructed options of the
 5 electing participants. The CSD receives the details of calculated entitlements from Issuer/issuer’s agent.

6 **5.2.2.3.4 Initiate T2S settlement**

Reference ID	T2S.BPD.SETT.VOLU.04
--------------	----------------------

7 T2S Actors: CSD

8 After receiving the CA election proceeds from the Issuer/Issuer’s Agent, the CSD initiates the settlement
 9 instructions to T2S to distribute CA proceeds (cash amount and/or securities quantity) to the CSD
 10 Participants, for each CA election that resulted in a successful blocking or debit of elected positions.

11 **5.2.2.3.4.1 Prepare Instruction**

Reference ID	T2S.BPD.SETT.VOLU.04.01
--------------	-------------------------

12 At the start of business on the payment date (prior to NTS settlement sequence 1) CSD creates settlement
 13 instructions based on the instructions received from the Issuer/Issuer’s agent to distribute the CA proceeds.
 14 The underlying security (and possibly cash) is booked out and depending upon the applicable CA election
 15 option, outturn securities and/or cash payments are made.

- 16 • For cash proceeds, the CSD creates “versus payment⁷⁹” instructions, for moving the blocked⁸⁰ securities
 17 positions from the CSD Participant’s securities account to CSD’s/ Issuer’s/ Issuer’s agent’s securities
 18 account, and for moving cash amount from CSD’s/ Issuer’s/ Issuer’s agent’s T2S DCA to participant’s
 19 T2S DCA.
- 20 • For securities proceeds only, the CSD creates “Free of payment” instructions for moving underlying
 21 securities positions from participant’s securities account to CSD’s/ Issuer’s/ Issuer’s agent’s securities
 22 account and for moving outturn securities positions from CSD’s/ Issuer’s/ Issuer’s agent’s securities

⁷⁹ If payment date is not market deadline date + 1 business day, CSD instructs debit of underlying securities, credit of cash and/or outturn securities on different dates in, T2S

⁸⁰ In case securities positions in the underlying ISIN are already debited earlier, CSD instructs T2S for credit of outturn securities or cash only

1 account to participant’s securities account. The CSD may link the settlement instructions for booking-in
 2 of outturn securities and the booking-out of underlying securities to settle on an “All-or-none” basis.

- 3 • Certain CA also require a debit of cash (e.g. rights subscriptions).

4 The indicative instruction types (from CSD’s/ Issuer’s/ Issuer’s agent’s perspective) are:

5 **Table 5-12: Instruction Types [T2S.BPD.SETT.VOLU.04.01]**

Proceeds type	Instruction Type	ISIN	Quantity	Amount
Cash	RVP	Underlying ISIN	Securities positions of the participant	Cash proceeds
Securities	RFP	Underlying ISIN	Securities positions of the participant	-
	DFP	Outturn ISIN	Securities proceeds for the participant	-
Securities with cash debit	RFP	Underlying ISIN	Securities positions of the participant	-
	DVP	Outturn ISIN	Securities proceeds for the participant	Amount as per the elected positions
Cash and securities	RVP	Underlying ISIN	Securities positions of the participant	Cash proceeds of the participant
	DFP	Outturn ISIN	Securities proceeds for the participant	-

6 In the settlement instruction for debiting the underlying ISIN from CSD Participant’s account, CSD must
 7 specify the reference of the blocked securities positions (as obtained via status advice in the activity “receive
 8 CA elections”).

9 Alternatively, if the CSD has segregated the participant’s elected positions by moving them to a different
 10 account (Issuer’s/ Issuer’s agent’s or Escrow), the CSD creates instructions to deliver cash and/or securities
 11 to participant.

12

1 The indicative instruction types (from CSD’s/ Issuer’s/ Issuer’s agent’s perspective) are:

2 **Table 5-13: Instruction Types [T2S.BPD.SETT.VOLU.04.01]**

Proceeds type	Instruction Type	ISIN	Quantity	Amount
Cash	RVP	Underlying ISIN	Zero	Cash proceeds of the participant
Securities	DFP	Outturn ISIN	Securities proceeds for the participant	-
Securities with cash debit	DVP	Outturn ISIN	Securities proceeds for the participant	Amount as per the elected positions
Cash and securities	RVP	Underlying ISIN	zero	Cash proceeds of the participant
	DFP	Outturn ISIN	Securities proceeds for the participant	-

3 In case of a cross-CSD scenario, the investor CSD invokes this process after the receipt of the CA proceeds
 4 from the Issuer CSD.

5 **5.2.2.3.4.2 Send Instructions to T2S**

Reference ID	T2S.BPD.SETT.VOLU.04.02
--------------	-------------------------

6 The CSD converts the settlement instruction enriched with T2S specific information and T2S process
 7 indicators into the required message format and transmits it to T2S. CSD sends these instructions to T2S at
 8 the start of business on the payment date⁸¹ (prior to NTS settlement sequence 1).

9 The CSD sends confirmation of the CA elections to its participants, once it receives the settlement
 10 confirmations from T2S in the activity “Manage settlement results”.

11 **5.2.2.3.5 T2S Processing**

12 For details on the T2S services involved in the processing of the settlement instruction, refer to process
 13 “Intra-CSD Settlement [T2S.BPD.SETT.ICSD]”.

⁸¹ In case CSD is not able to send CA related instructions to T2S prior to NTS sequence 1, CSD could block the underlying ISIN for settlement purpose except for CA instructions. Once the CA instructions are settled, CSD could unblock the underlying ISIN to allow trade related settlements. Refer fifth example in section 1.2.1.8 Restriction types of UDFS 1.2,

- 1 For details on the T2S services involved in the blocking of securities positions, refer to process “Reservation
- 2 and Blocking of Securities Position [T2S.BPD.SETT.RBSP]”.
- 3 For details on the T2S services involved in obtaining positions and validation of elections using queries, refer
- 4 to processes “Reports [T2S.BPD.INFO.REPT]”and “Queries [T2S.BPD.INFO.QUIRE]”.
- 5

1 **5.2.3 MANDATORY REORGANISATIONS WITH OPTIONS**
2 **[T2S.BPD.SETT.RGOP]**

3 **5.2.3.1 OVERVIEW**

4 This process describes the act of executing a mandatory organisation with options in T2S. A mandatory
5 reorganisation with options event is a mandatory reorganisation, where the investor has a choice of proceeds.

6 A “conversion” is an example of a mandatory reorganisation with options event (whereby the investor has a
7 choice of receiving e.g. cash and/or securities as proceeds).

8 This process is a variation of the process “Voluntary Reorganisations [T2S.BPD.SETT.VOLU]”. The steps
9 highlighted in the diagram below require particular attention.

10 **Trigger:**

11 The CSD receives the mandatory reorganisations with options event details from the relevant entity.

12 **Preconditions:**

13 None

14 **T2S Instructing Party:**

15 CSD

1 **5.2.3.2 BUSINESS PROCESS DIAGRAM**

2 **Figure 5-10: Business Process Diagram [T2S.BPD.SETT.RGOP]**

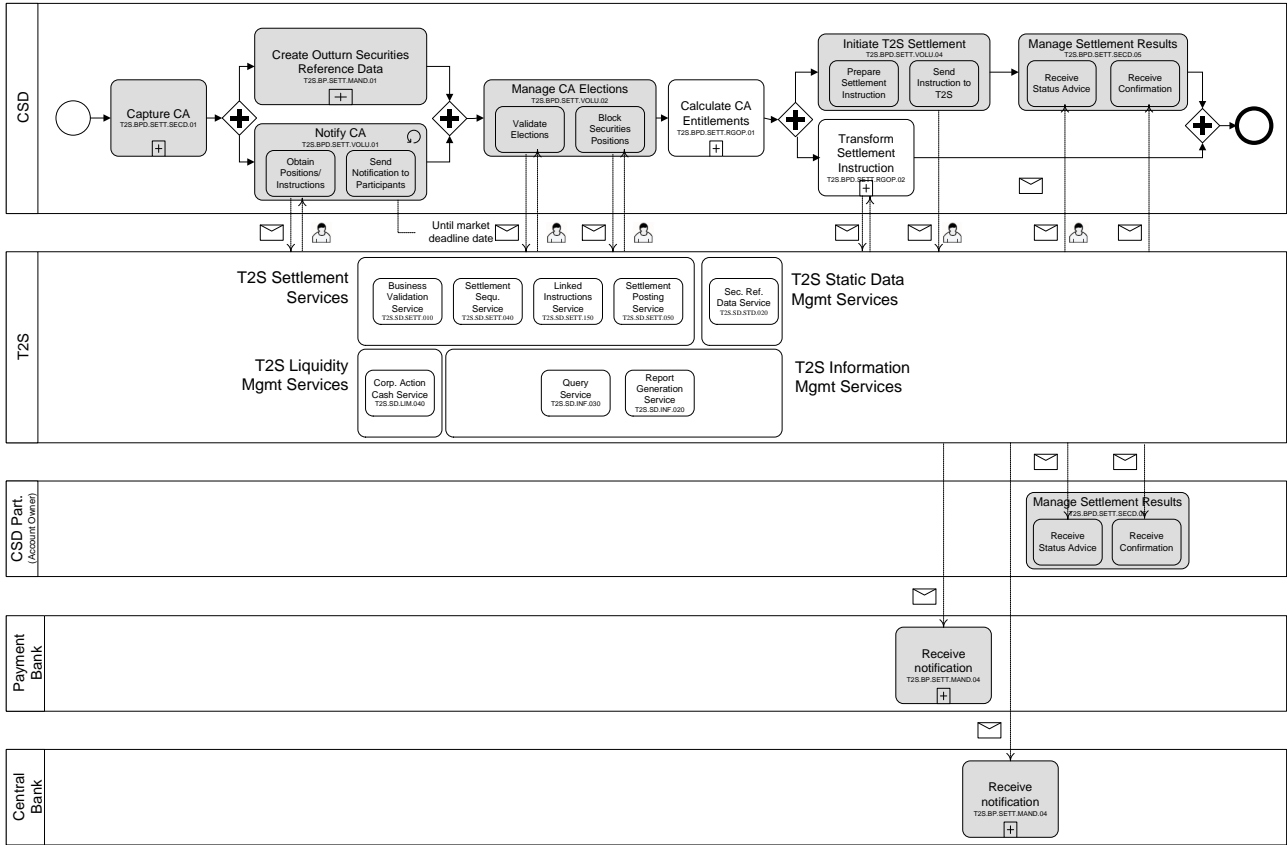

3

4 **5.2.3.3 BUSINESS PROCESS DESCRIPTION**

5 **5.2.3.3.1 Calculate CA Entitlements**

Reference ID	T2S.BPD.SETT.RGOP.01
--------------	----------------------

6 T2S Actors: CSD

7 When the payment date is reached, the CSD calculates the entitlements on positions where default option is
 8 applied. For the other types of options, the Issuer/Issuer’s Agent calculates the entitlements based on the
 9 securities positions that have been segregated accounting-wise and the related instructed options of the
 10 electing participants and sends the results to the CSD.

11

1 **5.2.3.3.2 Transform Settlement Instruction**

Reference ID	T2S.BPD.SETT.RGOP.02
--------------	----------------------

2 T2S Actors: CSD

3 The CSD initiates the cancellation of the pending settlement instructions on the underlying security in T2S
4 and sends the transformed settlement instructions on the outturn security and/or cash to T2S.

5 **5.2.3.3.3 T2S processing**

6 For details on the T2S services involved in the processing of the settlement instruction, refer to process
7 “Intra-CSD Settlement [T2S.BPD.SETT.ICSD]”.

8 For details on the T2S services involved in the transformation of a settlement instruction, refer to processes
9 “Cancellation of Settlement Instruction [T2S.BPD.SETT.CINS]” and “Intra-CSD Settlement
10 [T2S.BPD.SETT.ICSD]”.

11 For details on the T2S services involved in the blocking of an ISIN, refer to process “(Un)blocking of
12 Securities [T2S.BPD.STDA.BSEC]”.

13 For details on the T2S services involved in obtaining positions and validation of elections using queries, refer
14 to processes “Reports [T2S.BPD.INFO.REPT]” and “Queries [T2S.BPD.INFO.QUIRE]”.

15

1 **5.3 TRANSACTION MANAGEMENT**

2 **5.3.1 MARKET CLAIMS [T2S.BPD.SETT.MCLA]**

3 **5.3.1.1 OVERVIEW**

4 This process describes the act of handling market claims in T2S. Market claims is the process of reallocating
5 the proceeds of a distribution to the contractually entitled party. According to the CAJWG standards, a
6 market claim should be created as a separate (from the original) transaction in order to ensure that the
7 proceeds of a distribution with or without options reaches the entitled party without changing the underlying
8 transaction.

9 In line with the above mentioned market standards, the following types of CA events trigger the market
10 claims:

- 11 • Cash Distributions,
12 • Securities Distributions.

13 **Trigger:**

14 The process of identifying market claims runs after the Instruction Owner CSD (CSD (IOC)⁸²) receives the
15 final reporting of settlement instructions in T2S at the close of business on record date and everyday up to 20
16 T2S business days from the record date.

17 **Preconditions:**

18 None

19 **T2S Instructing Party:**

20 CSD

⁸² The Instruction Owner CSD (IOC) is the CSD that provides the securities accounts on which the participant has sent an underlying instruction. The IOC model is preferable for transaction management because in case of a cross CSD scenario, the intermediary CSD(s) between the two IOCs cannot initiate market claims on T2S generated realignment instructions. Only the IOCs can initiate market claims.

1 **5.3.1.2 BUSINESS PROCESS DIAGRAM**

2 **Figure 5-11: Business Process Diagram [T2S.BPD.SETT.MCLA]**

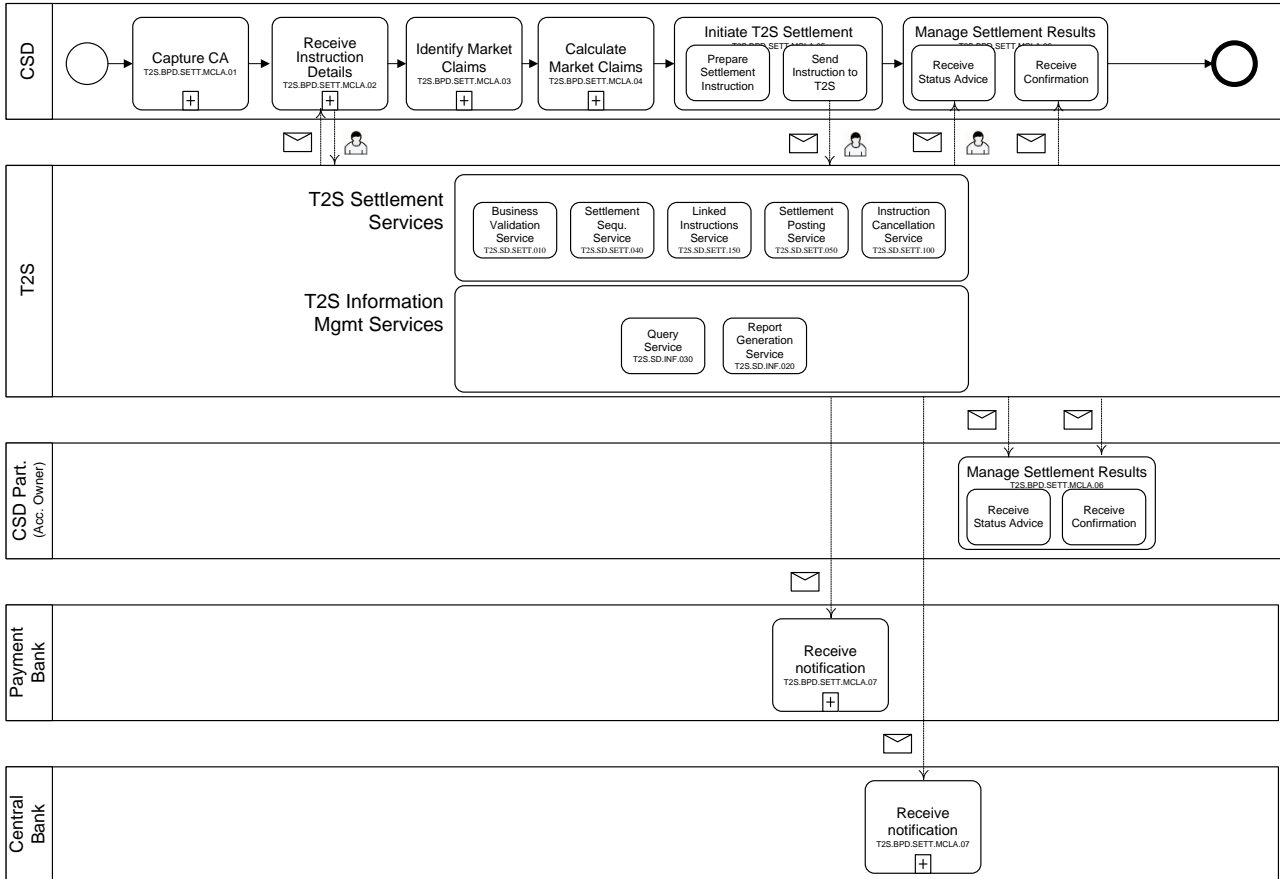

3

4 **5.3.1.3 BUSINESS PROCESS DESCRIPTION**

5 **5.3.1.3.1 Capture CA**

Reference ID	T2S.BPD.SETT.MCLA.01
--------------	----------------------

6 T2S Actors: CSD (IOC) ⁸³

7 The CSD (IOC) receives the distributions CA details from the relevant entities.

8

⁸³ Instruction Owning CSD is the CSD that provides the securities accounts on which the participant has sent an underlying instruction. IOC model is preferable for transaction management because in case of a cross CSD scenario, the intermediary CSD(s) between the two IOCs cannot initiate market claims on T2S generated realignment instructions. Only the IOCs can initiate market claims.

1 **5.3.1.3.2 Receive Instruction Details**

Reference ID	T2S.BPD.SETT.MCLA.02
--------------	----------------------

2 T2S Actors: CSD (IOC)

3 This process is triggered by the end of Record Date of the CA event and daily up to 20 T2S business days
4 after the Record Date.

5 The CSD (IOC) retrieves the settlement instruction details from T2S based on the CA details (i.e. one or
6 more CAs having the record date as the current date or within 20 days in the past). The CSD (IOC) uses the
7 settlement instruction details (e.g. trade date, intended and actual settlement date, ex and cum indicators,
8 status) to identify the settlement instructions that require a market claims process.

9 According to the T2S CA standards, the CSD (IOC) runs this process at least daily.

10 On the end of record date, the CSD considers settled or matched settlement instructions for identifying the
11 market claims. During the market claims detection period after the record date the CSD (IOC) identifies any
12 newli input matched settlement instructions (e.g. a settlement instruction with trade date before the ex-date
13 and the intended settlement date on or before the record date).

14 The CSD (IOC) has two options for receiving these details.

15 *Option 1*

16 T2S generates predefined reports at close of business of a settlement date (End of Day reporting). The CSD
17 (IOC) receives statement of pending instructions, delta statement of pending instructions and statement of
18 transactions (settled settlement instructions), delta statement of transactions report to be generated at fixed
19 time/event based on its report subscription set up in T2S [e.g. after intraday DVP cut-off, currently at 04.00
20 p.m.; and/or after FOP cut-off currently at 6:00 p.m.] The CSD (IOC) filters the reports in order to extract
21 details relevant to the underlying ISIN.

22 *Option 2*

23 The CSD (IOC) queries T2S specifying the underlying ISIN and/or trade date, settlement date, instruction
24 status as a filter criteria.

25

1 The CSD (IOC) sends and receive the following messages to/from T2S:

2 **Table 5-14: Messages to and from T2S [T2S.BPD.SETT.MCLA.02]**

Message Name	ISO Code	To/From T2S	Event	UDFS Chapter
SecuritiesSettlementTransactionQueryV01	semt.026.001.01	To T2S	-	3.3.7.12
SecuritiesStatusOrStatementQueryStatusAdviceV03	sese.022.001.03	From T2S	Query instruction is processed in T2S	3.3.8.3
SecuritiesSettlementTransactionQueryResponseV01	semt.027.001.01	From T2S	T2S prepares the response data	3.3.7.13
Statement of Pending Instructions (Complete /Delta)	semt.018.001.03	From T2S	T2S prepares the response data	3.3.7.7

3 References:

4 UDFS: Use Cases “Send Query” (Chapter 2.18) and “Receive Report” (Chapter 2.19)

5 GUI BFD: T2S.GUI.SESE.INX.0070

6 **5.3.1.3.3 Identify Market Claims**

Reference ID	T2S.BPD.SETT.MCLA.03
--------------	----------------------

7 T2S Actors: CSD (IOC)

8 Precondition: CSD (IOC) receives settlement instructions data at the close of business of the CA record date
 9 from T2S. And current date is within 20 business days from the record date.

10 The CSD (IOC) identifies and calculates the market claims based on the details of the settlement instructions
 11 consolidated in the process Receive Instruction Details. The CSD (IOC) sends to T2S, settlement instructions
 12 for processing of market claims for securities and cash distributions.

13 The CSD (IOC) will identify⁸⁴ the underlying transaction eligible for market claims:

- 14 • after the close of business on the record date of the CA event and
- 15 • during the rest of the market claims detection period (20 T2S business days after the record date) for the
- 16 matched settlement instructions sent to T2S.

⁸⁴ As per the T2S CA standards, the maximum period for claim detection will be 20 T2S business days from the record date.

1 In line with the T2S CA standards, the CSD (IOC) will identify market claims based on a set of parameters
2 corresponding to the attributes in a settlement instruction.

3 • Opt-out indicator⁸⁵ in the settlement instruction: The CSD (IOC) will exclude a settlement instruction
4 with an opt-out indicator set to “Yes” from market claims processing.

5 • Status of the settlement instruction: The CSD (IOC) will only include in the market claims detection
6 process settlement instructions in matched status⁸⁶ set to “Yes” and settlement status set to “Unsettled”
7 or “Settled”.

8 • Initiator of the settlement instruction: In line with the T2S CA standards, T2S generated settlement
9 instruction for realignments⁸⁷ should not be subject⁸⁸ to the CSD (IOC) market claims detection process.
10 However, T2S generated settlement instructions for reversal of client collateralisation will be subject to a
11 market claims detection process.

12 • For all matched T2S settlement transactions, CSD (IOC)s/CCPs should create market claims, as separate
13 (from the original underlying) transactions without changing the underlying transaction.

14 • Trade Date and Intended Settlement Date of the settlement instruction: Securities in units (e.g. shares):
15 This process applies to instructions that does not specify Ex/ Cum indicator. The CSD (IOC) creates
16 transfers from the seller to the buyer when the trade date is before Ex Date and there is a Pending
17 Transaction at close of business of Record Date. Alternatively, the CSD (IOC) creates transfers from the
18 buyer to the seller when trade date is on or after Ex Date and Actual Settlement Date is on or before
19 Record Date.

20 The identification of market claims in case of special ex- and special cum- trading (for securities in units) is
21 based on the following rules:

22 • Special ex-indicator: The trade date is before the ex-date, the actual settlement date is before the record
23 date and the ex indicator is set to yes, then the market claim is raised in favour of the seller. The trade
24 date is before the ex-date and transaction is still pending and the ex indicator is set to yes, then no market
25 claims will be raised.

26 • Special cum-indicator: The trade date is after the ex-date, actual settlement date is after the record date
27 and the cum indicator is set to yes, then the market claim is raised in favour of the buyer. The trade date

⁸⁵ T2S will consider the opt-out indicator as additional matching criteria if specified in a settlement instruction by the T2S instructing party.

⁸⁶ Refer to UDFS section 1.6.4.1.3 ‘Status management process’.

⁸⁷ The process of moving positions between omnibus accounts within a technical Issuer CSD, as a result of movement of positions between the participants’ accounts

⁸⁸ As market claims are also considered as settlement instructions in T2S, T2S identifies and creates realignments required for market claims as well.

1 is after the ex-date, and transaction is still pending and the cum indicator is set to yes, then market claim
 2 is raised in favour of the buyer.

- 3 • Securities in nominal amounts (e.g. debt instruments): This applies to instructions that does not specify
 4 Ex/ cum indicator. The CSD (IOC) creates transfers from the seller to the buyer if the Intended
 5 Settlement Date is on or before the Record Date and there is a Pending Transaction at close of business
 6 on Record Date.

7 *Cross CSD settlements and Market Claims*

8 In the cross CSD scenario the CSD (IOC)s owning the underlying settlement instructions related to the T2S
 9 generated realignment instructions will raise the relevant market claims for their participants.

10 Following the matching of the two market claims instructions sent to T2S by the CSD (IOC)s, T2S will
 11 create the relevant realignment instructions (between the accounts of all CSDs included in the link chain).
 12 The Issuer CSD will exclude the T2S generated realignment instructions from the market claims
 13 identification process.

14 **5.3.1.3.4 Calculate Market Claims**

Reference ID	T2S.BPD.SETT.MCLA.04
--------------	----------------------

15 After the identification of settlement instructions that require market claims generation, the CSD (IOC) will
 16 calculate the market claim quantity (i.e. securities positions) and the claim cash amount based on the CA
 17 event details and the securities settlement quantity in the underlying transaction. This activity also handles
 18 fractional market claims based on the information in the CA details.

19 **5.3.1.3.5 Initiate T2S Settlement**

Reference ID	T2S.BPD.SETT.MCLA.05
--------------	----------------------

20 T2S Actors: CSD (IOC)

21 During this process, the CSD (IOC) initiates the settlement instructions to T2S for market claims.

22 References:

23 UDFS: Use Case “Send Settlement Instruction” (Chapter 2.3)

24 GUI BFD: T2S.GUI.SESE.INX.0070

25

1 **5.3.1.3.5.1 Prepare Instruction**

Reference ID	T2S.BPD.SETT.MCLA.05.01
--------------	-------------------------

2 During this activity the CSD (IOC) creates the settlement instructions related to market claims.

3 According to the T2S CA standards, the CSD (IOC) will create the market claims related settlement
4 instructions with the following details:

- 5 • Special ISO Transaction Type Code – This code (‘CLAI’) is required to identify market claims related
6 settlement instruction.
- 7 • Reference⁸⁹ of Underlying Settlement Instruction – The CSD (IOC) should specify a of the underlying
8 settlement instruction.
- 9 • Link indicator - the CSD (IOC) should not link the market claim to the underlying settlement instruction.
10 However, in case the CSD (IOC) wants to ensure that the market claim settles after the underlying
11 settlement instruction, the CSD (IOC) may instruct the market claim related settlement instruction with a
12 hold status set to “Yes”. The CSD (IOC) will release this instruction upon receiving the settlement
13 confirmation of the underlying settlement instruction from T2S.
- 14 • CSD (IOC) CA Event Reference.
- 15 • Trade Date of the market claim will be the trade date of the underlying settlement instruction.
- 16 • Intended Settlement Date⁹⁰ of the market claim should be the payment date of the underlying CA
17 instruction.
- 18 • Partial Settlement indicator should be set to “No” for cash market claims. For securities market claims,
19 the partial settlement indicator should be set with the same value as of the underlying settlement
20 instruction.

21 The CSD (IOC) generates either free of payments (FOP) instructions for transfer of securities and/or
22 payment free of delivery (PFOD) instructions for transfer of cash depending upon the outturn of the
23 distribution CA event (i.e. distribution of securities only, cash only or both).

24

⁸⁹ According to the T2S market claims standard an appropriate reference which can be identified by the participants should be included. T2S reference of the settlement instruction is one of the possible references.

⁹⁰ Refer T2S standards for market claims, standard 18.

1 The indicative instruction types (from the perspective of counterparties entitled for the CA proceeds are):

2 **Table 5-15: Settlement Instruction Types for Market Claims [T2S.BPD.SETT.MCLA.05.01]**

Proceeds type	Instruction Type	ISIN	Quantity	Amount
Cash	DVP	Underlying ISIN	Zero	Cash entitlement on the underlying transaction
Securities	RFP	Outturn ISIN	Securities entitlement on the underlying transaction	Zero
Cash and securities ⁹¹	DVP	Underlying ISIN	Zero	Cash entitlement on the underlying transaction
	RFP	Outturn ISIN	Securities entitlement on the underlying transaction	Zero

3 **5.3.1.3.5.2 Send Instruction to T2S**

Reference ID	T2S.BPD.SETT.MCLA.05.02
--------------	-------------------------

4 The CSD (IOC) sends settlement instructions to T2S. Depending on the CA event (i.e. type of distribution),
 5 an CSD (IOC) may send either

- 6 • Settlement instructions for credit of securities only,
- 7 • Settlement instructions for credit of cash

8 The CSD (IOC) sends the following message to T2S:

9 In case the instructing parties of the underlying settlement instructions cancel their respective settlement
 10 instructions bilaterally, the CSD (IOC)s⁹² may also cancel the corresponding market claims. As per standard
 11 T2S cancellation procedures, matched market claims instructions are subject to bilateral cancellation whereas
 12 unmatched market claims are subject to unilateral cancellation.

⁹¹ In case CA proceeds include cash and securities, market claim could be instructed as a DWP.

⁹² If the CSD specifies the settlement instruction (the market claim) as modifiable by its participant, participant may cancel the settlement instruction (the market claim),

1 CSD (IOC)s can modify the process condition indicators⁹³ on the market claims (if required) as per the
 2 standard T2S procedures

3 **Table 5-16: Messages to T2S [T2S.BPD.SETT.MCLA.05.02]**

Message Name	ISO Code	To/From T2S	UDFS Chapter
SecuritiesSettlementTransactionInstruction	Sese.023.001.03	To T2S	3.3.8.4

4 **5.3.1.3.6 Manage Settlement Results**

Reference ID	T2S.BPD.SETT.MCLA.06
--------------	----------------------

5 T2S Actors: CSD (IOC) and CSD Participant

6 During this sub-process the CSD (IOC) and CSD Participant receive from T2S the settlement related
 7 messages and initiates related internal processes.

8 References:

9 UDFS: Use Case “Send Settlement Instruction” (Chapter 2.3)

10 **5.3.1.3.6.1 Receive Status Advice**

Reference ID	T2S.BPD.SETT.MCLA.06.01
--------------	-------------------------

11 During this activity the CSD (IOC) and CSD Participant receives the status advice messages for every
 12 change of status or reason code update to the settlement instruction within T2S.

13 The CSD (IOC) and CSD Participant receive the following message from T2S:

14 **Table 5-17: Messages from T2S [T2S.BPD.SETT.MCLA.06.01]**

Message Name	ISO Code	To/From T2S	Event	UDFS Chapter
SecuritiesSettlementTransactionStatusAdvice	Sese.024.001.03	From T2S	T2S changes status of settlement instruction	3.3.8.5

15

⁹³ Refers to indicators affecting the processing of the instruction. e.g. partial settlement, priority indicator.

1 **5.3.1.3.6.2 Receive Settlement Confirmation**

Reference ID	T2S.BPD.SETT.MCLA.06.02
--------------	-------------------------

2 During this activity the CSD (IOC) and CSD Participant receives from T2S the settlement confirmation
 3 messages for the settlement instructions sent to T2S by the CSD (IOC).

4 The CSD (IOC) and CSD Participant receive the following message from T2S:

5 **Table 5-18: Messages from T2S [T2S.BPD.SETT.MCLA.06.02]**

Message Name	ISO Code	To/From T2S	Event	UDFS Chapter
SecuritiesSettlementTransactionConfirmationV03	Sese.025.001.03	From T2S	T2S settles the settlement instruction	3.3.8.6

6 **5.3.1.3.7 Receive Notifications**

Reference ID	T2S.BPD.SETT.MCLA.07
--------------	----------------------

7 T2S Actors: Payment Bank and Central Bank (Both scenarios)

8 The Payment Bank and Central Bank receive a notification whenever a securities settlement instruction
 9 results in the debit or credit of one of their T2S dedicated cash accounts. If the cash posting has caused the
 10 T2S dedicated cash account to be lower than the floor or higher than the ceiling thresholds T2S sends a
 11 second notification message.

12 The Payment Bank and Central Bank may conduct additional tasks such as updating cash registers of the
 13 Payment Bank/Central Bank and liquidity management activities (e.g. resulting in a transfer of cash from or
 14 to T2S).

15

1 The Payment Bank and Central Bank receive the following messages from T2S:

2 **Table 5-19: Messages from T2S [T2S.BPD.SETT.MCLA.07]**

Message Name	ISO Code	To/From T2S	Event	UDFS Chapter
BankToCustomerDebitCreditNotificationV03	Camt.054.001.03	From T2S	Debit or Credit on T2S dedicated cash account	3.3.3.17
ReturnAccountV05	Camt.004.001.05	From T2S	Cash balance after the posting on the dedicated cash account is below the floor or above the ceiling thresholds set-up for the dedicated cash account	3.3.3.2

3 **5.3.1.3.8 T2S Processing**

4 For details on the T2S services involved in the processing of the settlement instruction, refer to process
 5 “Intra-CSD Settlement [T2S.BPD.SETT.ICSD]”.

6 For details on the T2S services involved in obtaining receiving instruction details, refer to process “Queries
 7 [T2S.BPD.INFO.QURE]”.

8

1 **5.3.2 TRANSFORMATIONS [T2S.BPD.SETT.TRAN]**

2 **5.3.2.1 OVERVIEW**

3 This process describes the act of handling transformations in T2S. Transformation is a process by which the
4 pending transactions (on or after record date/market deadline) are cancelled and replaced by new transactions
5 in accordance with the terms of the reorganisation.

6 In line with the CAJWG market standards, the following types of CA events lead to the transformation of a
7 pending transaction:

- 8 • Mandatory reorganisations,
- 9 • Mandatory reorganisations with options (with or without a valid buyer election) as a single event or as
10 the second part of the distribution event with options,
- 11 • Voluntary reorganisations where a valid buyer protection has been agreed (if the service is offered by the
12 CSD).

13 The processes described are in line with the CAJWG and T2S CA standards.

14 **Trigger:**

15 This process is executed by the CSD (IOC)s at the end of Record Date or by the end of market deadline of
16 the CA

17 **Preconditions:**

18 CA details are available to CSD (CSD (IOC))

19 **T2S Instructing Party:**

20 CSD

1 **5.3.2.2 BUSINESS PROCESS DIAGRAM**

2 **Figure 5-12: Business Process Diagram [T2S.BPD.SETT.TRAN]**

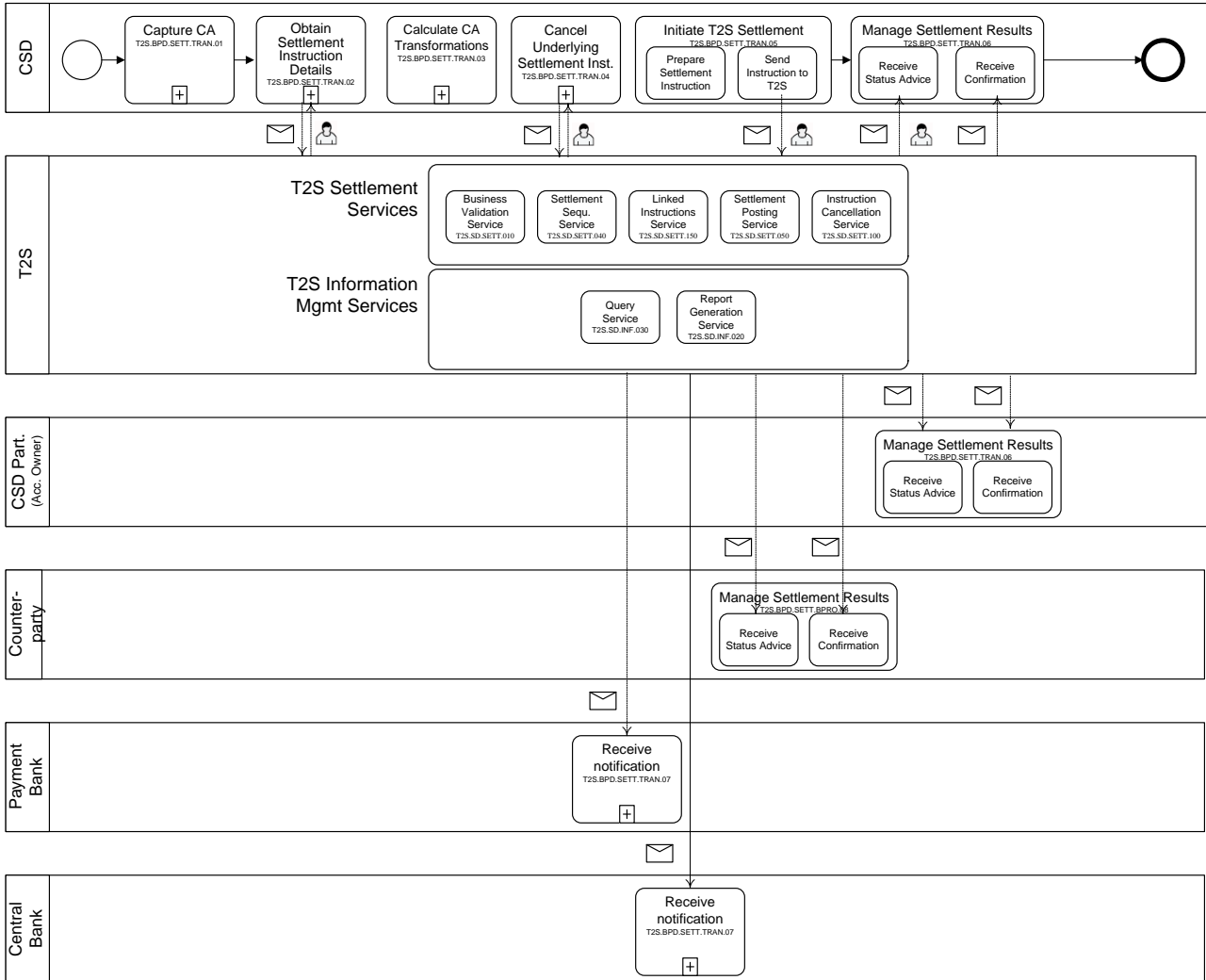

3

4 **5.3.2.3 BUSINESS PROCESS DESCRIPTION**

5 **5.3.2.3.1 Capture CA**

Reference ID	T2S.BPD.SETT.TRAN.01
--------------	----------------------

6 The CSD (IOC) captures the reorganisation CA details sent by the relevant entities (CA announcement).

7

1 **5.3.2.3.2 Obtain Settlement Instruction Details**

Reference ID	T2S.BPD.SETT.TRAN.02
--------------	----------------------

2 T2S Actors: CSD (IOC)⁹⁴ (also possible: CCP)

3 This process is triggered by the CSD (IOC) [CCP]'s by the end of Record Date or by the end of market
4 deadline of the CA.

5 This process retrieves from T2S the pending instructions on the underlying ISIN of the CA. This process
6 runs between the end of record date or the market deadline⁹⁵ of the CA reorganisation event and the start of
7 day of the next business day.

8 The CSD (IOC) has the option to either receive these details through

- 9 • predefined reports generated by T2S at close of business of a settlement date (End of Day reporting),
10 • or query T2S specifying underlying ISIN and/or trade date, settlement date, instruction status as a filter
11 criteria.

12 In option 1,

- 13 • the CSD (IOC) queries T2S for settlement instructions details related to each underlying ISIN.

14 In option 2,

- 15 • the CSD (IOC) receives statement of pending instructions, delta statement of pending instructions and
16 statement of transactions (settled settlement instructions), delta statement of transactions report to be
17 generated at fixed time/event based on its report subscription set up in T2S [e.g. after intraday DVP cut-
18 off, currently at 04.00 p.m.; and/or after FOP cut-off currently at 6:00 p.m.],
19 • the CSD (IOC) filters the reports in order to extract details relevant to the underlying ISIN.

20

⁹⁴ Instruction Owning CSD is the CSD that provides the securities accounts on which the participant has sent an underlying instruction. IOC model is preferable for transaction management because in case of a cross CSD scenario, the intermediary CSD(s) between the two IOCs cannot initiate transformations on T2S generated realignment instructions. Only the IOCs can initiate transformations.

⁹⁵ As per CAJWG definition

1 The CSD (IOC) [CCP] sends and receives the following messages to/from T2S:

2 **Table 5-20: Messages to and from T2S [T2S.BPD.SETT.TRAN.02]**

Message Name	ISO Code	To/From T2S	Event	UDFS Chapter
SecuritiesSettlementTransactionQueryV01	semt.026.001.01	To T2S	-	3.3.7.12
SecuritiesStatusOrStatementQueryStatusAdviceV03	sese.022.001.03	From T2S	Query instruction is processed in T2S	3.3.8.3
SecuritiesSettlementTransactionQueryResponseV01	semt.027.001.01	From T2S	T2S prepares the response data	3.3.7.13
Statement of Pending Instructions (Complete /Delta)	semt.018.001.03	From T2S	T2S prepares the response data	3.3.7.7

3 References:

4 UDFS: Use Cases “Send Query” (Chapter 2.18) and “Receive Report” (Chapter 2.19)

5 GUI BFD: T2S.GUI.SESE.INX.0070

6 **5.3.2.3.3 Calculate CA Transformations**

Reference ID	T2S.BPD.SETT.TRAN.03
--------------	----------------------

7 T2S Actors: CSD (IOC) (also possible: CCP)

8 Precondition: Latest settlement instructions data from T2S is available at the close of business of the CA
 9 record date or the CA market deadline date and the instruction is eligible for transformation

10 The CSD (IOC) [CCP] calculates the CA transformations based on the pending settlement instructions in the
 11 underlying securities at the close of business of the CA record/market deadline date

12 In line with the T2S CA standards, during this process the CSD (IOC) [CCP] calculates the CA
 13 transformations depending upon the type of the following transformation events:

14 *Transformation into new securities with single or multiple outturns:*

15 Based on the CA details (i.e. conversion ratios between the outturn securities and underlying securities) and
 16 the settlement quantity (underlying securities) of the pending settlement instruction, the CSD (IOC) [CCP]’s
 17 calculate the settlement quantity of the outturn.

1 *Transformation into cash:*

2 Based on the CA details (rates provided by the issuer/issuer’s agent) and the settlement quantity (underlying
3 securities) of the pending settlement instruction, CSD (IOC) [CCP]’s calculate the cash outturn

4 *Treatment of fractions:*

5 If the settlement quantity (outturn securities) of the transformed settlement instruction results in fraction and
6 the issuer/issuer’s agent does not compensate fractions in cash, then the CSD (IOC)s/CCPs round down the
7 settlement quantity (outturn securities) to the nearest whole number.

8 If the issuer/issuer’s agent compensates fractions in cash, then the CSD (IOC) [CCP]’s create an additional
9 PFOOD settlement instruction with the same characteristics as the underlying settlement instruction and sets
10 the settlement quantity of the outturn securities to zero. The cash amount calculated equals the number of
11 residual fractions multiplied by the “compensation price” as announced by the issuer/issuer’s agent.

12 **5.3.2.3.4 Cancel Settlement Instructions**

Reference ID	T2S.BPD.SETT.TRAN.04
--------------	----------------------

13 T2S Actors: CSD (IOC) (also possible: CCP)

14 The CSD (IOC) [CCP] initiates cancellation of pending settlement instructions on the underlying ISIN that
15 were not already cancelled by the CSD participants earlier.

16 For details on the cancellation of a settlement instruction, refer to process “Cancellation of Settlement
17 Instruction”.

18 The table below lists the possible CSD (IOC) [CCP] actions in T2S.

19 **Table 5-21 CSD (IOC) [CCP] Actions in T2S [T2S.BPD.SETT.TRAN.04]**

Originator of settlement instruction	T2S status of settlement instruction	Action in T2S
T2S Actor	Unsettled and Unmatched ⁹⁶	CSD (IOC)s/CCPs can cancel the settlement instruction unilaterally ⁹⁷

⁹⁶ Unmatched instructions have not been specified in the scope of T2S CA standards for transformations. IOC can choose to (i) cancel the instruction unilaterally, Or (ii) wait for the counter party to send settlement instruction in the underlying security, once matched cancel bi-laterally and transform the instruction (provided it is still within the transformation detection period).

⁹⁷ If the settlement instruction has references to blocked or reserved securities status, IOC/CCP perform CA on stock on the underlying securities and should attach the reference of the blocked/reserved outturn securities to the transformed settlement instruction.

Originator of settlement instruction	T2S status of settlement instruction	Action in T2S
T2S Actor	Unsettled and Matched	<p>Scenario 1 - Both settlement instructions have the same CSD (IOC) (intra-CSD scenario)</p> <p>CSD (IOC) can cancel the matched settlement instruction using an already matched cancellation instruction.</p> <p>Scenario 2 - The matched pair of settlement instructions have different CSD (IOC) (Inter-CSD scenario)</p> <p>Both CSD (IOC)s can cancel their respective settlement instructions in matched status. T2S executes the cancellation instructions for the pending settlement instructions only upon receipt of both cancellation instructions from CSD (IOC)s</p>
T2S Actor	Partially Settled	Following partial settlement, CSD (IOC)/CCP instructs T2S for the cancellation of the pending quantity of the settlement quantity (which is not yet settled).
T2S Actor	CoSD Hold	Settlement Instruction on CoSD Hold can be cancelled only by the Administering Party ⁹⁸
T2S Actor	Party Hold/ CSD Hold/ CSD Validation Hold	CSD (IOC) instructs T2S for the cancellation of the pending settlement instructions (on hold)

⁹⁸ Administrating parties are identified by the CSDs, and are responsible for releasing the instructions that are identified as CoSD (that needs fulfilling an external condition).

Originator of settlement instruction	T2S status of settlement instruction	Action in T2S
T2S (settlement instructions for realignment in cross-CSD settlement scenarios)	Same status as the corresponding underlying settlement instruction sent by T2S Actor	CSD (IOC)s/CCPs cannot cancel the T2S generated settlement instructions intended for realignment in cross CSD environment. T2S cancels the realignment instructions when the CSD (IOC)s/CCPs instruct cancellation of the corresponding business instructions.
T2S (settlement instructions generated for client collateralisation reimbursements)	Party Hold	CSD (IOC) has to identify pending collateral reimbursement instructions in T2S and instruct cancellation to T2S.

1 The CSD (IOC) [CCP] sends and receive the following messages to/from T2S:

2 **Table 5-22: Messaged to and from T2S [T2S.BPD.SETT.TRAN.04]**

Message Name	ISO Code	To/From T2S	Event	UDFS Chapter
SecuritiesTransactionCancellationRequestV03	sese.020.001.03	To T2S	-	3.3.8.1
SecuritiesTransactionCancellationRequestStatusAdviceV03	sese.027.001.03	From T2S	T2S processes the cancellation request	3.3.8.7
SecuritiesSettlementTransactionStatusAdviceV03	Sese.024.001.03	From T2S	T2S receives the cancellation of settlement instruction from only one party of the transaction. Or the original cancellation instruction is cancelled by the instructing party,	3.3.8.5

3

1 **5.3.2.3.5 Initiate T2S Settlement**

Reference ID	T2S.BPD.SETT.TRAN.05
--------------	----------------------

2 T2S Actors: CSD (IOC) (also possible: CCP)

3 The CSD (IOC) [CCP] initiates the settlement instructions in outturn securities to T2S.

4 References:

5 UDFS: Use Case “Send Settlement Instruction” (Chapter 2.3)

6 GUI BFD: T2S.GUI.SESE.INX.0070

7 **5.3.2.3.5.1 Prepare Instruction**

Reference ID	T2S.BPD.SETT.TRAN.05.01
--------------	-------------------------

8 The CSD (IOC) [CCP] creates the settlement instructions related to the outturn securities and/or cash.

9 *Transformation into new securities with single or multiple outturns*

10 For single outturns, The CSD (IOC) [CCP] creates settlement instructions (outturn securities) with the same
 11 characteristics (e.g. trade date, cash consideration) as those of the original settlement instructions (underlying
 12 securities). Only the following fields in respect with the terms of the reorganisation can change:

- 13 • the quantity of securities,
- 14 • the ISIN,
- 15 • the settlement date (SD).

16 For multiple outturns (i.e. multiple new ISINs being generated by the transformation process), the CSD
 17 (IOC) [CCP] creates multiple settlement instructions. The new settlement instructions do not settle as linked
 18 settlement in T2S. The transformed instructions should retain the same characteristics (e.g. trade date) as the
 19 original settlement instruction (underlying securities). Only the following fields in respect with the terms of
 20 the reorganisation can change:

- 21 • the quantity of securities,
- 22 • the cash consideration should be allocated to the transformed transactions according to the securities
 23 ratios provided by the issuer/issuer’s agent,
- 24 • the ISIN,
- 25 • the settlement date (SD),

26 *Transformation into cash*

1 According to the T2S CA standards, CSD (IOC) [CCP] should create the cash transfer(s) settlement
 2 instructions with the same characteristics as those of the original settlement instruction of the underlying
 3 securities. If the settlement instruction (underlying securities) was against payment, two new instructions
 4 (Payment Free of Delivery - PFODs), in opposite directions, will be created.

- 5 • Settlement instruction for the settlement amount,
- 6 • Settlement instruction for the cash outturn.

7 CSD (IOC) [CCP] should not link the two settlement instructions. CSD (IOC)s [CCP] create only one
 8 transfer for the cash outturn, if the original settlement instruction (underlying securities) was free of
 9 payment.

10 *Treatment of fractions*

11 If the settlement quantity (outturn securities) of the reinstructed settlement instruction results in fraction and
 12 the issuer/issuer’s agent does not compensate fractions in cash, then the CSD (IOC) [CCP] create the
 13 settlement instructions with the settlement quantity (outturn securities) rounded down to the nearest whole
 14 number. If the issuer/issuer’s agent compensates⁹⁹ fractions in cash, then the CSD (IOC) [CCP] create an
 15 additional settlement instruction with the same characteristics as those of the original settlement instruction
 16 (underlying securities) and set the settlement quantity of the outturn securities to zero.

17 **5.3.2.3.5.2 Send Instruction to T2S**

Reference ID	T2S.BPD.SETT.TRAN.05.02
--------------	-------------------------

18 The CSD (IOC) [CCP] sends settlement instructions in outturn securities and/or cash to T2S, at the close of
 19 business of the CA record/market deadline date.

20 The CSD (IOC) [CCP] sends the following message to T2S:

21 **Table 5-23: Messages to T2S [T2S.BPD.SETT.TRAN.05.02]**

Message Name	ISO Code	To/From T2S	UDFS Chapter
SecuritiesSettlementTransactionInstruction	Sese.023.001.03	To T2S	3.3.8.4

22 **5.3.2.3.6 T2S Processing**

23 For details on the T2S services involved in the processing of the settlement instruction, refer to process
 24 “Intra-CSD Settlement [T2S.BPD.SETT.ICSD]”.

⁹⁹ The cash amount calculated equals the number of residual fractions multiplied by the ‘compensation price’ as announced by the issuer/issuer’s agent.

1 For details on the T2S services involved in the cancellation of the underlying settlement instruction, refer to
 2 process “Cancellation of Settlement Instruction [T2S.BPD.SETT.CINS]”.

3 For details on the T2S services involved in obtaining settlement instruction details, refer to processes
 4 “Reports [T2S.BPD.INFO.REPT]” and “Queries [T2S.BPD.INFO.QUIRE]”.

5 **5.3.2.3.7 Manage Settlement Results**

Reference ID	T2S.BPD.SETT.TRAN.06
--------------	----------------------

6 T2S Actors: CSD (IOC) (also possible: CCP) and CSD Participant

7 The CSD (IOC) [CCP] and CSD Participant receives the settlement related messages from T2S and initiate
 8 related internal processes.

9 References:

10 UDFS: Use Case “Send Settlement Instruction” (Chapter 2.3)

11 **5.3.2.3.8 Receive Status Advice**

Reference ID	T2S.BPD.SETT.TRAN.06.01
--------------	-------------------------

12 The CSD (IOC) [CCP] and CSD Participant receive status advice messages for every change of status or
 13 update of reason code to the settlement instruction within T2S.

14 The CSD (IOC) [CCP] and CSD Participant receives the following message from T2S:

15 **Table 5-24: Messages from T2S [T2S.BPD.SETT.TRAN.06.01]**

Message Name	ISO Code	To/From T2S	Event	UDFS Chapter
Securities Settlement Transaction Status Advice	Sese.024.001.03	From T2S	T2S changes status of settlement instruction	3.3.8.5

16 **5.3.2.3.8.1 Receive Settlement Confirmation**

Reference ID	T2S.BPD.SETT.TRAN.06.02
--------------	-------------------------

17 The CSD (IOC) [CCP] and CSD Participant receive settlement confirmation messages for the settlement
 18 instructions sent to T2S by the CSD (IOC) [CCP].

19

1 The CSD (IOC) [CCP] and CSD Participant receive the following message from T2S:

2 **Table 5-25: Messages from T2S [T2S.BPD.SETT.TRAN.06.02]**

Message Name	ISO Code	To/From T2S	Event	UDFS Chapter
SecuritiesSettlementTransactionConfirmationV03	Sese.025.001.03	From T2S	T2S settles the settlement instruction	3.3.8.6

3 **5.3.2.3.9 Receive Notifications**

Reference ID	T2S.BPD.SETT.TRAN.07
--------------	----------------------

4 T2S Actors: Payment Bank and Central Bank (Both scenarios)

5 The Payment Bank and Central Bank receive a notification whenever a securities settlement instruction
 6 results in the debit or credit of one of their T2S dedicated cash accounts. If the cash posting has caused the
 7 T2S dedicated cash account to be lower than the floor or higher than the ceiling thresholds T2S sends a
 8 second notification message.

9 The Payment Bank and Central Bank may conduct additional tasks such as updating cash registers of the
 10 Payment Bank/Central Bank and liquidity management activities (e.g. resulting in a transfer of cash from or
 11 to T2S).

12 The Payment Bank and Central Bank receive the following messages from T2S:

13 **Table 5-26: Messages from T2S [T2S.BPD.SETT.TRAN.07]**

Message Name	ISO Code	To/From T2S	Event	UDFS Chapter
BankToCustomerDebitCreditNotificationV03	Camt.054.001.03	From T2S	Debit or Credit on T2S dedicated cash account	3.3.3.17
ReturnAccountV05	Camt.004.001.05	From T2S	Cash balance after the posting on the dedicated cash account is below the floor or above the ceiling thresholds set-up for the dedicated cash account	3.3.3.2

14

1 **5.3.3 BUYER PROTECTION [T2S.BPD.SETT.BPRO]**

2 **5.3.3.1 OVERVIEW**

3 This process describes the act of conducting a buyer protection procedure in T2S. Buyer protection is a
4 process whereby a buyer¹⁰⁰ who has yet to receive the underlying securities of an elective CA¹⁰¹, instructs the
5 seller in order to receive the outturn of his choice. The business process description in this section covers the
6 interaction of the CSD's offering Buyer Protection service¹⁰², with T2S.

7 **Trigger:**

8 The CSD receives the Elective CA details from relevant entity

9 **Preconditions:**

10 None

11 **T2S Instructing Party:**

12 CSD

¹⁰⁰ BP can also apply to bilateral securities lending and collateral management related activities

¹⁰¹ Elective CA: Distribution with options, mandatory reorganisation with options or voluntary reorganisation

¹⁰² In case the CSD does not offer a BP service, the counterparts of the trade should interact bilaterally to handle the BP process.

1 **5.3.3.2 BUSINESS PROCESS DIAGRAM**

2 **Figure 5-13: Business Process Diagram [T2S.BPD.SETT.BPRO]**

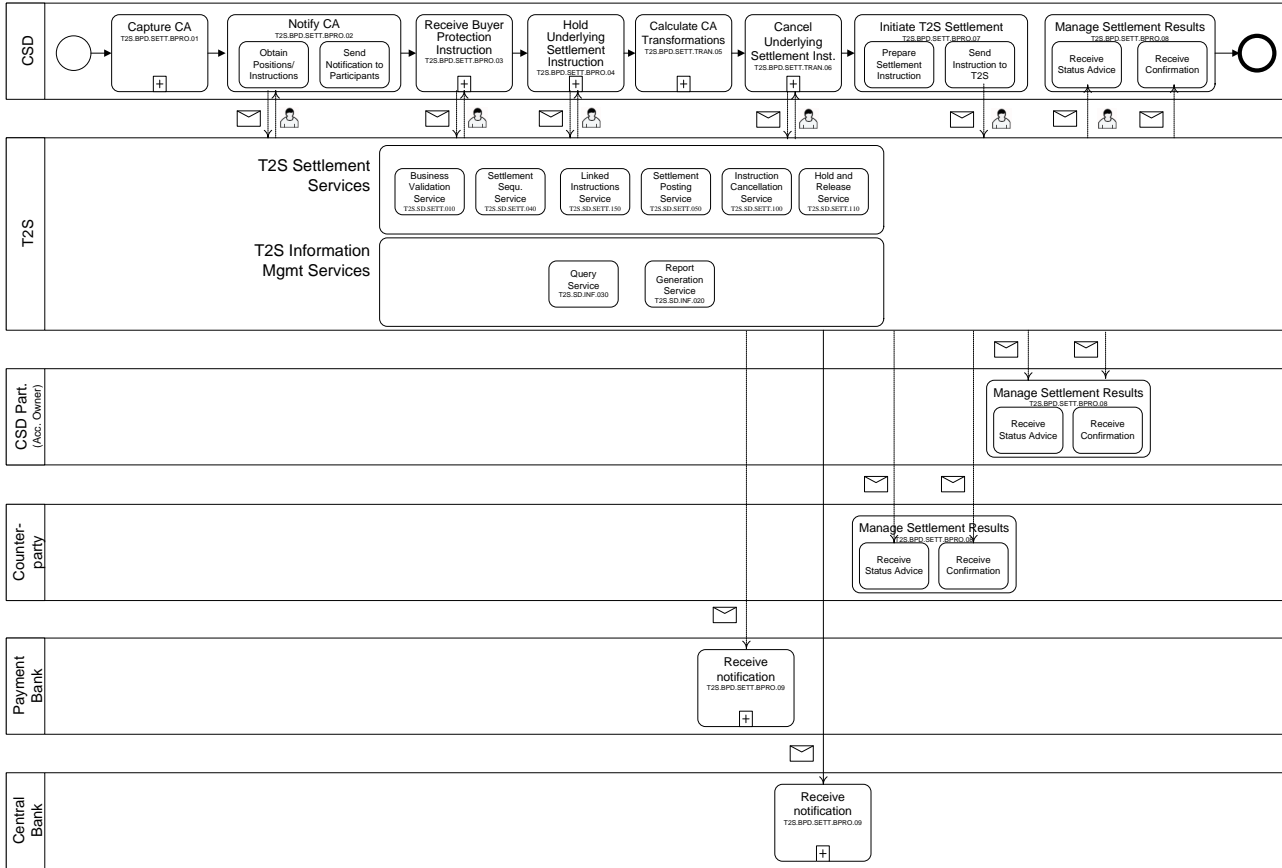

3

4 **5.3.3.3 BUSINESS PROCESS DESCRIPTION**

5 **5.3.3.3.1 Capture CA**

Reference ID	T2S.BPD.SETT.BPRO.01
--------------	----------------------

6 T2S Actors: CSD

7 The CSD captures the CA events of type “Distributions with options” (as 2 events, distribution, and
 8 mandatory reorganisation with options), “Mandatory reorganisations with options” and “Voluntary
 9 reorganisations”.

10 **5.3.3.3.2 Notify CA**

Reference ID	T2S.BPD.SETT.BPRO.02
--------------	----------------------

11 T2S Actors: CSD

1 The CSD identifies the eligible recipients based on the CA details (ISIN, market deadline date etc) and the
 2 T2S information. The CSD informs eligible recipients about the CA details. This process runs until the
 3 market deadline date of the CA event.

4 **5.3.3.3.3 Receive Buyer Protection Instruction**

Reference ID	T2S.BPD.SETT.BPRO.03
--------------	----------------------

5 T2S Actors: CSD

6 The CSD performs a validity check for the BP instruction sent by the buyer to the seller (e.g. CA reference,
 7 option number, and underlying settlement instruction).

8 The CSD queries T2S for relevant settlement instructions on the underlying ISIN. Upon receiving response
 9 from T2S, the CSD checks the status of the underlying settlement instruction (e.g. if the instruction is settled,
 10 cancelled).

11 The process is relevant only for the CSDs that offer Buyer Protection functionality to its participants.

12 **Table 5-27: Messages to and from T2S [T2S.BPD.SETT.BPRO.02.01]**

Message Name	ISO Code	To/From T2S	Event	UDFS Chapter
SecuritiesSettlementTransactionQueryV01	semt.026.001.01	To T2S	-	3.3.7.12
SecuritiesStatusOrStatementQueryStatusAdviceV03	sese.022.001.03	From T2S	Query instruction is processed in T2S	3.3.8.3
SecuritiesSettlementTransactionQueryResponseV01	semt.027.001.01	From T2S	T2S prepares the response data	3.3.7.13

13 **5.3.3.3.4 Hold Underlying Settlement Instruction**

Reference ID	T2S.BPD.SETT.BPRO.04
--------------	----------------------

14 T2S Actors: CSD

15 Precondition: Existence of valid Buyer Protection instruction linked.

1 When the BP deadline¹⁰³ is reached, the CSD identifies the pending settlement instruction related to the
 2 Buyer Protection. The CSD instructs T2S to put the underlying settlement instruction on hold using a
 3 maintenance instruction¹⁰⁴.

4 For details on the holding of a settlement instruction, refer to process “Hold of Settlement Instruction
 5 [T2S.BPD.SETT.HOLD]”.

6 **5.3.3.3.5 Calculate CA Transformation**

Reference ID	T2S.BPD.SETT.BPRO.05
--------------	----------------------

7 T2S Actors: CSD

8 The CSD calculates CA transformations based on the underlying pending settlement instructions in the
 9 underlying ISIN.

10 **5.3.3.3.6 Cancel Underlying Settlement Instruction**

Reference ID	T2S.BPD.SETT.BPRO.06
--------------	----------------------

11 T2S Actors: CSD

12 The CSD sends to T2S cancellation instructions to cancel the settlement instructions on the underlying
 13 securities.

14 For details on the cancellation of a settlement instruction, refer to process “Cancellation of Settlement
 15 Instruction [T2S.BPD.SETT.CINS]”.

16 **5.3.3.3.7 Initiate T2S Settlement**

Reference ID	T2S.BPD.SETT.BPRO.07
--------------	----------------------

17 T2S Actors: CSD

18 The CSD sends to T2S settlement instructions on the outturn securities and/or cash and the new settlement
 19 instructions in the outturn securities.

20 For details on the instruction of T2S, refer to processes “Intra-CSD Settlement [T2S.BPD.SETT.ICSD]”.

21

¹⁰³ According to the CAJWG and the T2S CA standards, BP deadline is T+n+2hours (where T is guaranteed participation date, n = settlement cycle)

¹⁰⁴ In case the BP is not offered by the CSD, the buyer and seller need to agree to cancel and/or replace underlying settlement instruction and instruct T2S, when relevant

1 **5.3.3.3.8 T2S processing**

2 For details on the T2S services involved in the processing of the settlement instruction, refer to process
3 “Intra-CSD Settlement [T2S.BPD.SETT.ICSD]”.

4 For details on the T2S services involved in the cancellation of the underlying settlement instruction, refer to
5 process “Cancellation of Settlement Instruction [T2S.BPD.SETT.CINS].

6 For details on the T2S services involved in the hold of the underlying settlement instruction, refer to process
7 “Hold Underlying Settlement Instruction [T2S.BPD.SETT.HOLD]”.

8 For details on the T2S services involved in obtaining positions and receiving the buyer protection instruction,
9 refer to processes “Reports [T2S.BPD.INFO.REPT]” and “Queries [T2S.BPD.INFO.QUIRE]”.

10 **5.3.3.3.9 Manage Settlement Results**

Reference ID	T2S.BPD.SETT.BPRO.08
--------------	----------------------

11 T2S Actors: CSD and CSD Participant

12 The CSD receives the settlement related messages (as a response to cancellation of underlying instructions,
13 settlement instructions on the outturn securities) from T2S and initiate related internal processes.

14 The CSD Participant receives the settlement related messages (as a result of cancelled settlement instructions
15 on the underlying security, new settlement instructions on the outturn security) from T2S and initiate related
16 internal processes.

17 For details on the messages received from T2S, refer to processes “Intra-CSD Settlement
18 [T2S.BPD.SETT.ICSD]”.

1 **6. LIQUIDITY MANAGEMENT PROCESSES**

2 **6.1 TRANSFER OF LIQUIDITY FROM RTGS TO T2S [T2S.BPD.LQMG.INBD]**

3 **6.1.1 OVERVIEW**

4 This process describes the act of transferring liquidity from an RTGS system to T2S. A Payment Bank as a
5 client of a Central Bank can have dedicated cash accounts in T2S to facilitate securities settlement for itself
6 or for its clients to which it provides cash settlement services. For this purpose, a Payment Bank needs to
7 fund liquidity in its dedicated cash accounts in T2S from a cash account in RTGS (either its own or from its
8 liquidity provider).

9 **Trigger:**

10 This process starts when the Payment Bank/Central Bank intends to transfer liquidity from an RTGS account
11 to a T2S dedicated cash account. Regardless of who instructs in the RTGS system, the Central Bank as the
12 owner of the RTGS system initiates the interaction with T2S.

13 **Preconditions:**

14 None

15 **T2S Instructing Party:**

16 Central Bank

17 Payment Banks (as clients of Central Banks) can instruct their relevant RTGS as well, which will forward
18 the liquidity transfer to T2S. Since interaction of T2S actors (in this case the Central Bank's RTGS system)
19 with their participants is not within the scope of the BPD, the instructions sent to the RTGS by Payment
20 Banks are not included in this process.

1 **6.1.2 BUSINESS PROCESS DIAGRAM**

2 **Figure 6-1: Business Process Diagram [T2S.BPD.LQMG.INBD]**

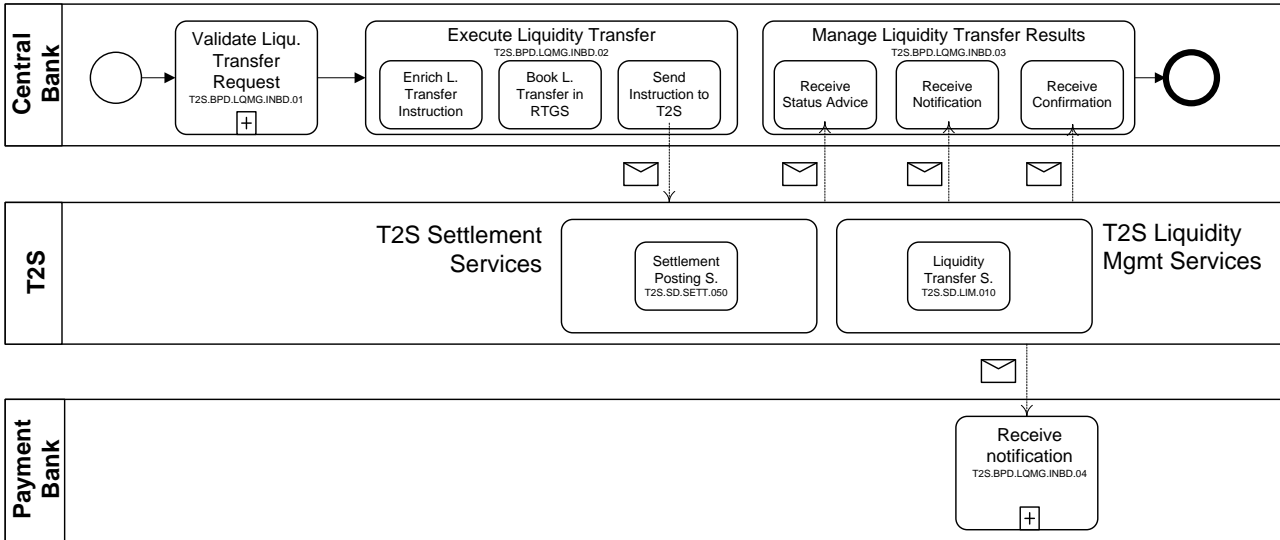

3

4 **6.1.3 BUSINESS PROCESS DESCRIPTION**

5 **6.1.3.1 VALIDATE LIQUIDITY TRANSFER REQUEST**

Reference ID	T2S.BPD.LQMG.INBD.01
--------------	----------------------

6 T2S Actors: Central Bank

7 The Central Bank checks all the details related to a liquidity transfer against the reference data (maintained
8 by the Central Bank or Payment Bank) and may perform additional checks and validations.

9 **6.1.3.2 EXECUTE LIQUIDITY TRANSFER**

Reference ID	T2S.BPD.LQMG.INBD.02
--------------	----------------------

10 T2S Actors: Central Bank

11 The Central Bank enriches the liquidity transfer instruction with details required for the transfer of liquidity
12 from the RTGS system to T2S and sends the liquidity transfer instruction to T2S as a A2A message, after
13 booking the transfer in its RTGS system.

14 References:

15 UDFS: Use Case “Execution of Liquidity Transfer from RTGS to T2S” (Chapter 2.15)

16 **6.1.3.2.1 Enrich Liquidity Transfer Request**

Reference ID	T2S.BPD.LQMG.INBD.02.01
--------------	-------------------------

1 The Central Bank enriches the liquidity transfer instructions with specific information such as account
 2 numbers, amounts, etc. It might want to use the user interfaces and query facilities in the RTGS system or
 3 T2S to get the necessary information.

4 **6.1.3.2.2 Book Liquidity Transfer in RTGS**

Reference ID	T2S.BPD.LQMG.INBD.02.02
--------------	-------------------------

5 The Central Bank performs the booking between RTGS account and the T2S dedicated transit account, for
 6 the transfer amount in the RTGS system.

7 **6.1.3.2.3 Send Instruction to T2S**

Reference ID	T2S.BPD.LQMG.INBD.02.03
--------------	-------------------------

8 The Central Bank converts the liquidity transfer enriched with specific information into the required message
 9 format and transmits it to T2S as an A2A message.

10 The Central Bank sends the following message to T2S:

11 **Table 6-1: Messages to T2S [T2S.BPD.LQMG.INBD.02.03]**

Message Name	ISO Code	To/From T2S	UDFS Chapter
LiquidityCreditTransfer	camt.050.001.03	To T2S	3.3.3.13

12 **6.1.3.3 T2S PROCESSING**

13 The **Liquidity Transfer Service (T2S.SD.LIM.010)** validates the instruction (LiquidityCreditTransfer) and
 14 initiates the settlement for the liquidity transfer. The result of the validation is communicated to the relevant
 15 parties via a status advice (Receipt).

16 The **Settlement Posting Service (T2S.SD.SETT.050)** performs the provisioning and booking of the
 17 liquidity transfer instruction between the RTGS dedicated transit account and the T2S dedicated cash
 18 account and sends out the posting notifications (BankToCustomerDebitCreditNotification) as well as
 19 confirmations (Receipt) to all involved parties. In addition this service communicates the fulfilled floor
 20 and/or ceiling conditions on the involved accounts to the relevant parties (Return Account).

21

1 **6.1.3.4 MANAGE LIQUIDITY TRANSFER RESULTS**

Reference ID	T2S.BPD.LQMG.INBD.03
--------------	----------------------

2 T2S Actors: Central Bank

3 The Central Bank receives the liquidity transfer related messages from T2S and initiates related internal
4 processes.

5 References:

6 UDFS: Use Case “Execution of Liquidity Transfer from RTGS to T2S” (Chapter 2.15)

7 **6.1.3.4.1 Receive Status Advice**

Reference ID	T2S.BPD.LQMG.INBD.03.01
--------------	-------------------------

8 The Central Bank receives status advice messages in case of rejection of the Liquidity Transfer Request in
9 T2S.

10 Following the message reception, other internal activities might be conducted such as:

- 11 • aligning the status of the liquidity transfer instruction in the Central Bank’s systems with the status in
12 T2S,
- 13 • triggering notification to their relevant clients.

14 The Central Bank receives the following message from T2S:

15 **Table 6-2: Messages from T2S [T2S.BPD.LQMG.INBD.03.01]**

Message Name	ISO Code	To/From T2S	Event	UDFS Chapter
Receipt	camt.025.001.03	From T2S	Rejection by T2S of an “inbound liquidity transfer” from RTGS to T2S	3.3.3.12

16 **6.1.3.4.2**

17

1 **6.1.3.4.3 Receive Notification**

Reference ID	T2S.BPD.LQMG.INBD.03.02
--------------	-------------------------

2 The Central Bank receives alert and posting notifications when the liquidity transfer is booked in T2S.
 3 Following the message reception, other internal activities might be conducted such as:

- 4 • aligning the status of the liquidity transfer instruction in the Central Bank’s or Payment Bank’s systems
 5 with the status in T2S,
- 6 • triggering notification to their relevant clients.

7 The Central Bank receives the following messages from T2S, due to posting on the RTGS transit account:

8 **Table 6-3: Messages from T2S [T2S.BPD.LQMG.INBD.03.02]**

Message Name	ISO Code	To/From T2S	Event	UDFS Chapter
Return Account	camt.004.001.05	From T2S	Cash balance after the posting on the T2S dedicated cash account is below the floor or above the ceiling thresholds set-up for the dedicated cash account	3.3.3.2
BankToCustomerDebitCreditNotificationV03	camt.054.001.03	From T2S	Confirmation of the debit or credit cash posting on a T2S dedicated cash account	3.3.3.17

9 **6.1.3.4.4 Receive Confirmation**

Reference ID	T2S.BPD.LQMG.INBD.03.03
--------------	-------------------------

10 The Central Bank receives and validates the settlement confirmations of the liquidity transfers, sent by T2S.

11 Following the message reception, other internal activities might be conducted such as:

- 12 • aligning the status of the liquidity transfer instruction in the Central Bank’s books with the status in T2S,
- 13 • triggering notification to their relevant clients.

14 The Central Bank receives the following message from T2S:

1 **Table 6-4: Messages from T2S [T2S.BPD.LQMG.INBD.03.03]**

Message Name	ISO Code	To/From T2S	Event	UDFS Chapter
Receipt	camt.025.001.03	From T2S	As an information to the Central Bank indicating the settlement status of the liquidity transfer in T2S	3.3.3.2

2 **6.1.3.5 RECEIVE NOTIFICATION**

Reference ID	T2S.BPD.LQMG.INBD.04
--------------	----------------------

3 T2S Actors: Payment Bank

4 The Payment Bank receives the credit posting notifications as well as floor and ceiling notifications due to
 5 postings on the T2S dedicated cash accounts, in the same way as detailed for the Central Bank.

6

1 6.2 INTRADAY TRANSFER OF LIQUIDITY FROM T2S TO RTGS 2 [T2S.BPD.LQMG.OTBD]

3 6.2.1 OVERVIEW

4 This process describes the act of transferring liquidity from a Dedicated Cash Account in T2S to the RTGS
5 system. A Central Bank and/or a Payment Bank can have a dedicated cash account in T2S to facilitate
6 securities settlement for itself or to its clients to which it provides cash settlement services. For these
7 purposes, a Central Bank and/or a Payment Bank funds liquidity in its dedicated cash account in T2S from a
8 cash account in RTGS (either its own or its liquidity provider).

9 At any moment in time during a settlement day in T2S, it may be required for a Central Bank and/or a
10 Payment Bank to transfer the liquidity from its T2S dedicated cash account to an RTGS cash account (either
11 its own or its liquidity provider) due to its liquidity needs in the RTGS system.

12 The Payment Bank has three options to initiate a liquidity transfer in T2S, where a user in the Payment
13 Bank/Central Bank can capture the transfer via T2S GUI (or) T2S can create it based on an instruction from
14 a Payment Bank/Central Bank:

- 15 • as an immediate liquidity transfer for immediate execution or
- 16 • as a predefined liquidity transfer for a delayed execution or
- 17 • as a standing liquidity transfer for a delayed and repeated execution.

18 **Trigger:**

19 This process starts when the Payment Bank/Central Bank intends to transfer liquidity from its T2S dedicated
20 cash account to an RTGS cash account:

- 21 • either the Central Bank receives liquidity transfer related details from its Payment Bank to instruct on its
22 behalf, or
- 23 • the Payment Bank or Central Bank as T2S dedicated cash account operator instructs the liquidity
24 transfers directly in T2S.

25 **Preconditions:**

26 None

27

1 **T2S Instructing Party:**

2 There are two scenarios for the instruction of T2S:

- 3 • Scenario A¹⁰⁵: Payment Bank instructs T2S.
- 4 • Scenario B: Central Bank instructs T2S on behalf of the Payment Bank.

5 **6.2.2 BUSINESS PROCESS DIAGRAM**

6 Scenario A: Payment Bank instructs T2S.

7 **Figure 6-2: Business Process Diagram [T2S.BPD.LQMG.OTBD/Scen. A]**

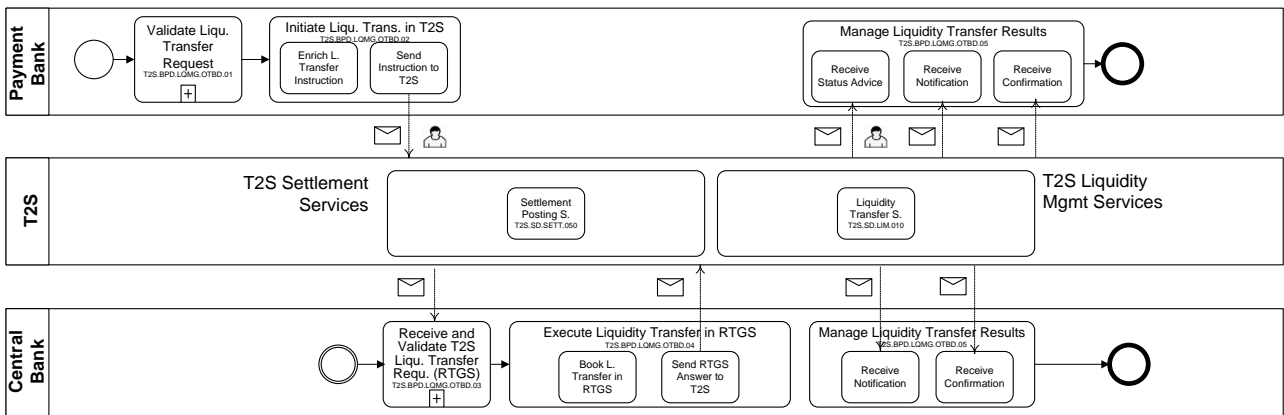

9 Scenario B: Central Bank instructs T2S on behalf of the Payment Bank.

10 **Figure 6-3: Business Process Diagram [T2S.BPD.LQMG.OTBD/Scen. B]**

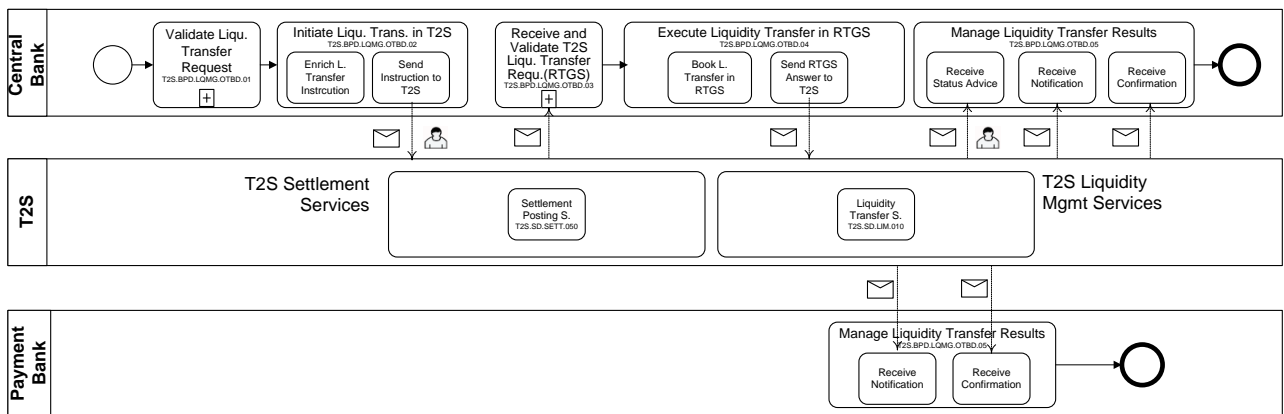

11

¹⁰⁵ This scenario is applicable for the case when Central Bank instructs for its own

1 **6.2.3 BUSINESS PROCESS DESCRIPTION**

2 This Business Process Description is applicable to Scenario A and B unless otherwise noted. For the purpose
 3 of readability, the actor names in the text refer to Scenario A with the Scenario B actor indicated in square
 4 brackets.

5 **6.2.3.1 VALIDATE LIQUIDITY TRANSFER REQUEST**

Reference ID	T2S.BPD.LQMG.OTBD.01
--------------	----------------------

6 T2S Actors: Payment Bank (Scenario A)/Central Bank (Scenario B)

7 The Payment Bank [Central Bank] checks all the details related to a liquidity transfer against the reference
 8 data (maintained by the Central Bank or Payment Bank) and may perform additional checks/validations.

9 **6.2.3.2 INITIATE LIQUIDITY TRANSFER IN T2S**

Reference ID	T2S.BPD.LQMG.OTBD.02
--------------	----------------------

10 T2S Actors: Payment Bank (Scenario A)/Central Bank (Scenario B)

11 The Payment Bank [Central Bank] enriches the liquidity transfer instruction with details required for transfer
 12 of liquidity from T2S to the RTGS system and sends the liquidity transfer instruction to T2S.

13 The instruction of T2S is also possible via the T2S GUI.

14 References:

15 UDFS: Use Case “Send Immediate Liquidity Transfer” (Chapter 2.13)

16 GUI BFD: T2S.GUI.LMSE.INX.0040

17 **6.2.3.2.1 Enrich Liquidity Transfer Instruction**

Reference ID	T2S.BPD.LQMG.OTBD.02.01
--------------	-------------------------

18 The Payment Bank [Central Bank] enriches the liquidity transfer instructions with specific information such
 19 as account numbers, amounts, etc. The Payment Bank [Central Bank] might want to use the query facilities
 20 in the RTGS system or T2S to get the necessary information.

21 **6.2.3.2.2 Send Instruction to T2S**

Reference ID	T2S.BPD.LQMG.OTBD.02.02
--------------	-------------------------

22 The Payment Bank [Central Bank] converts the liquidity transfer enriched with specific information into the
 23 required message format and sends it to T2S as an instruction (or placed in T2S using the T2S GUI).

1 The Payment Bank [Central Bank] sends the following message to T2S:

2 **Table 6-5: Messages to T2S [T2S.BPD.LQMG.OTBD.02]**

Message Name	ISO Code	To/From T2S	UDFS Chapter
LiquidityCreditTransfer	camt.050.001.03	To T2S	3.3.3.13

3 **6.2.3.3 T2S PROCESSING (PART I)**

4 The **Liquidity Transfer Service (T2S.SD.LIM.010)** validates the instruction (LiquidityCreditTransfer) and
 5 initiates the settlement for the liquidity transfer in T2S and sends an outbound liquidity transfer instruction to
 6 the RTGS (LiquidityCreditTransfer)

7 **6.2.3.4 RECEIVE AND VALIDATE LIQUIDITY TRANSFER REQUEST (RTGS)**

Reference ID	T2S.BPD.LQMG.OTBD.03
--------------	----------------------

8 T2S Actors: Central Bank

9 The Central Bank checks all the details related to a liquidity transfer against the reference data (maintained
 10 by the Payment Bank) and may perform additional checks/validations.

11 The Central Bank (RTGS!) receives the following message from T2S:

12 **Table 6-6: Messages from T2S [T2S.BPD.LQMG.OTBD.03]**

Message Name	ISO Code	To/From T2S	Event	UDFS Chapter
LiquidityCreditTransfer	camt.050.001.03	From T2S	Settlement of an outbound liquidity transfer in T2S	3.3.3.13

13 **6.2.3.5 EXECUTE LIQUIDITY TRANSFER IN RTGS**

Reference ID	T2S.BPD.LQMG.OTBD.04
--------------	----------------------

14 T2S Actors: Central Bank

15 The Central Bank receives the liquidity transfer related messages from T2S and initiates related transfer in
 16 the RTGS system.

17 References:

18 UDFS: Use Case “Send RTGS answer” (Chapter 2.14)

19

1 **6.2.3.5.1 Book Liquidity Transfer in RTGS**

Reference ID	T2S.BPD.LQMG.OTBD.04.01
--------------	-------------------------

2 The Central Bank performs the booking between T2S dedicated transit account and the RTGS account
3 specified in the liquidity transfer instruction, for the transfer amount.

4

1 **6.2.3.5.2 Send RTGS answer to T2S**

Reference ID	T2S.BPD.LQMG.OTBD.04.02
--------------	-------------------------

2 The Central Bank sends the results of the processing of the liquidity transfer instruction to T2S.

3 The Central Bank sends the following message to T2S:

4 **Table 6-7: Messages to T2S [T2S.BPD.LQMG.OTBD.04.02]**

Message Name	ISO Code	To/From T2S	UDFS Chapter
Receipt	camt.025.001.03	To T2S	3.3.3.12

5 **6.2.3.6 T2S PROCESSING (PART II)**

6 The **Liquidity Transfer Service (T2S.SD.LIM.010)** processes the answer (Receipt) from the RTGS system.

7 The **Settlement Posting Service (T2S.SD.SETT.050)** performs the provisioning and booking of the
 8 liquidity transfer instructions between the RTGS dedicated transit account and the T2S dedicated cash
 9 accounts and sends out the posting notifications (BankToCustomerDebitCreditNotification) as well as
 10 confirmations (Receipt) to all involved parties. In addition this service communicates the fulfilled floor
 11 and/or ceiling conditions on the involved accounts to the relevant parties (Return Account).

12 **6.2.3.7 MANAGE LIQUIDITY TRANSFER RESULTS**

Reference ID	T2S.BPD.LQMG.OTBD.05
--------------	----------------------

13 T2S Actors: Central Bank and Payment Bank (both scenarios)

14 The Central Bank and Payment Bank receive the liquidity transfer related messages from T2S and initiate
 15 related internal processes.

16 References:

17 UDFS: Use Case “Send Immediate Liquidity Transfer” (Chapter 2.13), Use Case “Send RTGS answer”
 18 (Chapter 2.14)

19 **6.2.3.7.1 Receive Status Advice**

Reference ID	T2S.BPD.LQMG.OTBD.05.01
--------------	-------------------------

20 In case of Scenario A, the Payment Bank receives status advice messages for acceptance or rejection of the
 21 liquidity transfer instruction within T2S. Following the message reception, other internal activities might be
 22 conducted such as:

- 1 • aligning the status of the liquidity transfer instruction in its systems with the status in T2S,
- 2 • triggering notification to their relevant clients.

3 The instruction of T2S is also possible via the T2S GUI.

4 In case of Scenario B, only the Central Bank receives the status advice messages.

5 **Table 6-8: Messages from T2S [T2S.BPD.LQMG.OTBD.05.01]**

Message Name	ISO Code	To/From T2S	Event	UDFS Chapter
Receipt	camt.025.001.03	From T2S	rejection or acceptance of an outbound liquidity transfer	3.3.3.12

6 **6.2.3.7.2 Receive Notifications**

Reference ID	T2S.BPD.LQMG.OTBD.05.02
--------------	-------------------------

7 The Central Bank and Payment Bank receive posting notifications and potentially floor and ceiling
 8 notifications when the liquidity transfer is booked in T2S. In addition the Central Bank can also receive
 9 notifications from the processing of the “RTGS Answer”. Following the message reception, other internal
 10 activities might be conducted such as:

- 11 • aligning the status of the liquidity transfer instruction in its systems with the status in T2S,
- 12 • triggering notification to their relevant clients.

13 The Central Bank and Payment Bank receive the following messages from T2S:

14 **Table 6-9: Messages from T2S [T2S.BPD.LQMG.OTBD.05.02]**

Message Name	ISO Code	To/From T2S	Event	UDFS Chapter
Return Account	camt.004.001.05	From T2S	cash balance after the posting on the T2S dedicated cash account is below the floor or above the ceiling thresholds set-up for the dedicated cash account	3.3.3.2
BankToCustomerDebitCreditNotificationV03	camt.054.001.03	From T2S	Confirmation of the debit or credit cash posting on a T2S dedicated cash account	3.3.3.17

Message Name	ISO Code	To/From T2S	Event	UDFS Chapter
Receipt	camt.025.001.03	From T2S	As an information to the Central Bank when the RTGS sends an “invalid” or a “rejection” as an RTGS Answer	3.3.3.2

1 **6.2.3.7.3 Receive Confirmations**

Reference ID	T2S.BPD.LQMG.OTBD.05.03
--------------	-------------------------

2 In case of Scenario A, the Payment Bank receives and validate settlement confirmations for the liquidity
 3 transfers sent by T2S.

4 Following the message reception, other internal activities might be conducted such as:

- 5 • aligning the status of the liquidity transfer instruction in its books with the status in T2S,
- 6 • triggering notification to their relevant clients.

7 In case of Scenario B, only the Central Bank receives the confirmation messages.

8 **Table 6-10: Messages from T2S [T2S.BPD.LQMG.OTBD.05.03]**

Message Name	ISO Code	To/From T2S	Event	UDFS Chapter
Receipt	camt.025.001.03	From T2S	T2S informs the status of the liquidity transfer to the relevant Payment Banks	3.3.3.2

9

1 **6.3 MULTIPLE LIQUIDITY PROVIDER TRANSFER OF LIQUIDITY FROM** 2 **T2S TO RTGS [T2S.BPD.LQMG.MLPT]**

3 **6.3.1 OVERVIEW**

4 This process describes the transfer of liquidity from T2S to multiple liquidity providers in RTGS. A Central
5 Bank and/or a Payment Bank can have a dedicated cash account in T2S to facilitate securities settlement for
6 itself or to its client(s) to which it provides cash settlement services. For these purposes, a Central Bank
7 and/or a Payment Bank funds liquidity in its dedicated cash account in T2S.

8 T2S enables its T2S Actors to receive liquidity from different RTGS accounts (i.e. from different liquidity
9 providers) to a single T2S Dedicated Cash Account. The Multiple Liquidity Provider functionality can be
10 used to automatically retransfer the liquidity remaining at the end of the Night-time settlement phase from
11 the T2S Dedicated Cash Accounts of the T2S Actor to the RTGS accounts of its liquidity providers, provided
12 that liquidity had initially been transferred to the T2S Dedicated Cash Account from these RTGS Accounts.
13 This feature is restricted to Night-time settlement window.

14 This process is a variation of the process “Intraday Transfer of Liquidity from T2S to RTGS
15 [T2S.BPD.LQMG.OTBD]”. The steps highlighted in the diagram below require particular attention.

16 **Trigger:**

17 The multiple liquidity provider reimbursement related liquidity transfers are triggered at the night-time
18 settlement in T2S during settlement sequence Y.

19 **Precondition:**

20 The multiple liquidity provider reimbursement is setup in T2S static data.

21 **T2S Instructing Party:**

22 Central Bank

1 **6.3.2 BUSINESS PROCESS DIAGRAM**

2 **Figure 6-4: Business Process Diagram [T2S.BPD.LQMG.MLPT]**

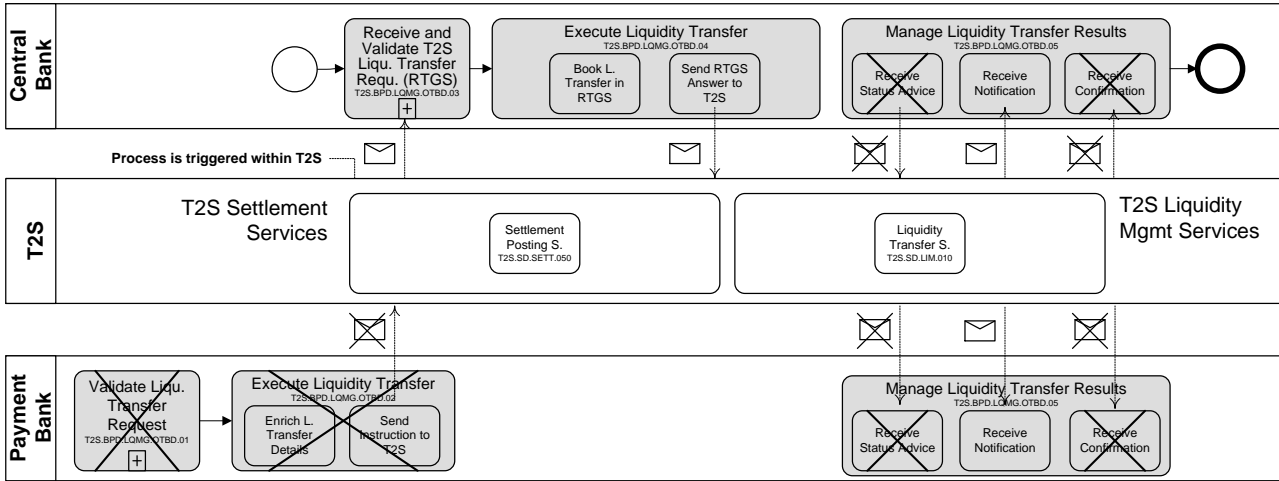

3

4 **6.3.3 BUSINESS PROCESS DESCRIPTION**

5 The processing of multiple liquidity provider related liquidity transfers is triggered from within T2S. The
 6 following processes and activities of the base process are not applicable:

- 7
- 8 • Validate Liquidity Transfer request,
 - 9 • Execute Liquidity Transfer in T2S,
 - 10 • Manage Liquidity Transfer results (Receive Status Advice, Receive confirmations).

11 References:

12 UDFS: Use Case “Maintain Static Data” (Chapter 2.20; for SD object as “Liquidity Transfer Order”)

13 GUI BFD: Section 4.12 “Multiple Liquidity Providers”

14 **6.3.3.1 T2S PROCESSING**

15 **The Liquidity Transfer Service (T2S.SD.LIM.010)** generates the liquidity transfer based on standing
 16 liquidity transfer orders when processing night-time settlement sequence Y. It also initiates the settlement of
 17 the generated liquidity transfer and sends an outbound liquidity transfer instruction to the RTGS and
 subsequently processes the answer from the RTGS system.

18 For more details on the T2S services involved, refer to “Intraday Transfer of Liquidity from T2S to RTGS
 19 [T2S.BPD.LQMG.OTBD]”.

20

1 **6.4 TRANSFER OF LIQUIDITY WITHIN T2S [T2S.BPD.LQMG.INLT]**

2 **6.4.1 OVERVIEW**

3 This process describes the act of transferring Liquidity within T2S. A Central Bank and/or a Payment Bank
4 can have one or more dedicated cash accounts in T2S to facilitate securities settlement for itself or to its
5 client(s) to which it provides cash settlement services. Trade settlement, Repo, Securities lending and
6 borrowing, reimbursement of intraday credit due to securities settlement are typical examples of such
7 securities settlement instructions using cash. For this purpose, a Central Bank and/or a Payment Bank can
8 manage funds between T2S dedicated cash accounts, after an inflow of funds.

9 | At any moment in time during a settlement day in T2S it may be required for a ~~Central Bank and/or a~~
10 Payment Bank to transfer the liquidity from its T2S dedicated cash account to another T2S dedicated cash
11 | account, either its own (or) linked to the same RTGS account. The transfer of liquidity is also possible if one
12 | or both accounts are T2S Central Bank accounts. Whenever one of the involved accounts is a Dedicated
13 | Transit Account Liquidity Transfers are always possible. The Central Bank or Payment Bank can instruct
14 T2S via an immediate liquidity credit transfer.

15 **Trigger:**

16 This process starts when the Payment Bank or Central Bank intends to transfer liquidity from its T2S
17 dedicated cash account to another T2S dedicated cash account:

- 18 • either the Central Bank receives liquidity transfer related details from its Payment Bank to instruct on its
19 half, or
- 20 • the Payment Bank or Central Bank as T2S dedicated cash account operator instructs the liquidity
21 transfers directly in T2S.

22 **Precondition:**

23 None

24

1 **T2S Instructing Party:**

2 There are two scenarios for the instruction of T2S:

- 3 • Scenario A: Payment Bank instructs T2S¹⁰⁶.
- 4 • Scenario B: Central Bank instructs T2S on behalf of the Payment Bank.

5 **6.4.2 BUSINESS PROCESS DIAGRAM**

6 Scenario A: Payment Bank instructs T2S.

7 **Figure 6-5: Business Process Diagram [T2S.BPD.LQMG.INLT/Scen. A]**

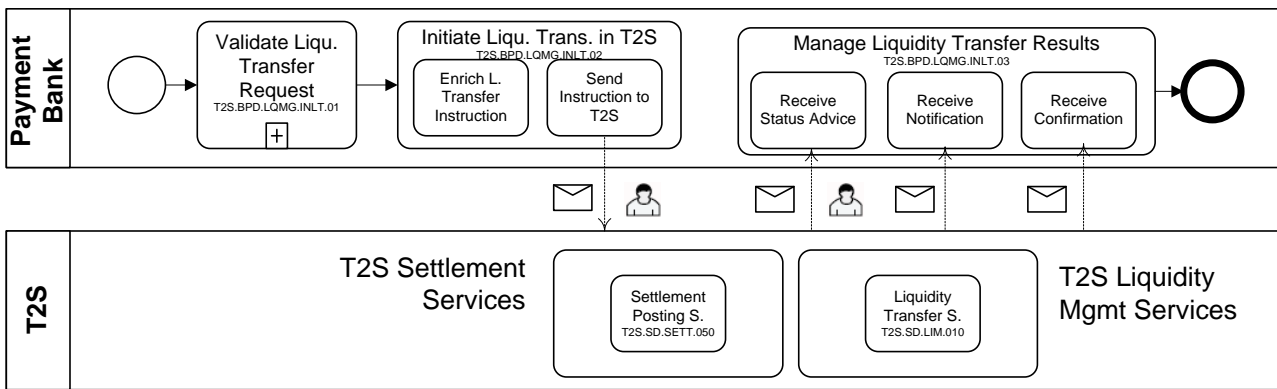

8

9

¹⁰⁶ This scenario is applicable for the case when Central Bank instructs for its own

1 Scenario B: Central Bank instructs T2S on behalf of the Payment Bank.

2 **Figure 6-6: Business Process Diagram [T2S.BPD.LQMG.INLT/Scen. B]**

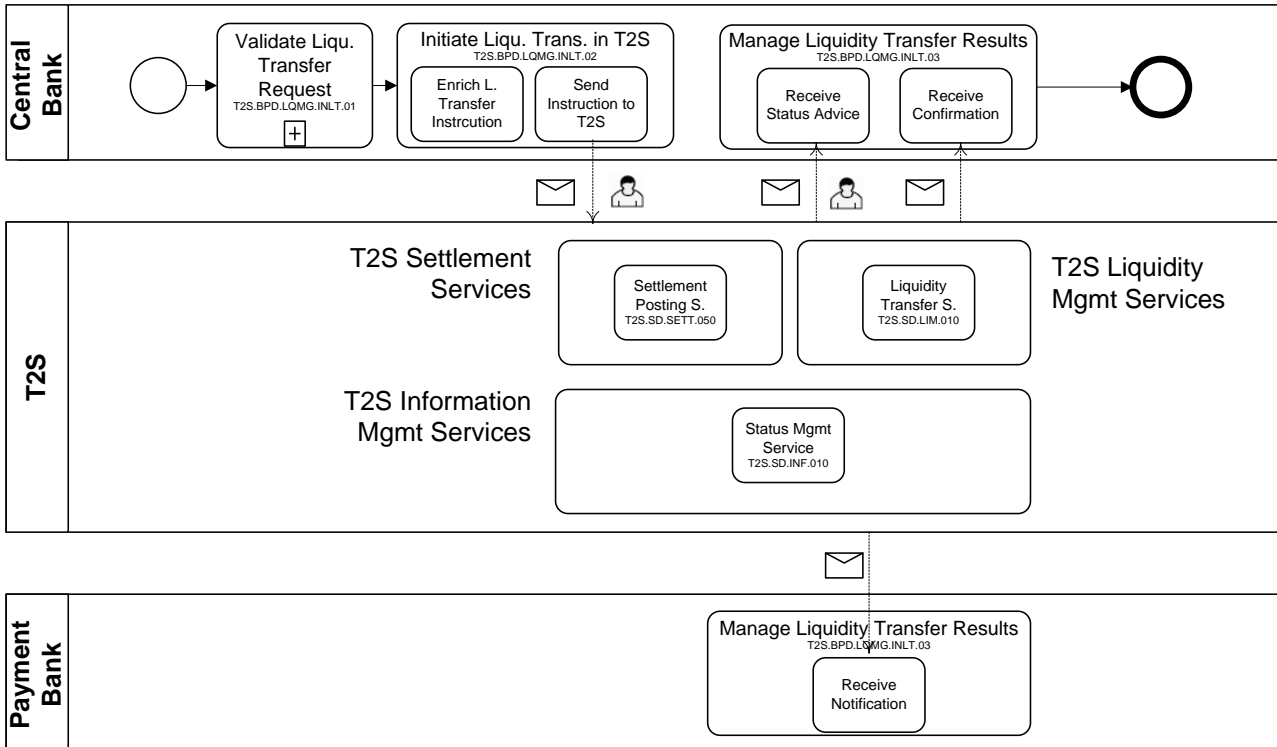

3

4 **6.4.3 BUSINESS PROCESS DESCRIPTION**

5 This Business Process Description is applicable to Scenario A and B unless otherwise noted. For the purpose
 6 of readability, the actor names in the text refer to Scenario A with the Scenario B actor indicated in square
 7 brackets.

8 **6.4.3.1 VALIDATE LIQUIDITY TRANSFER REQUEST**

Reference ID	T2S.BPD.LQMG.INLT.01
---------------------	-----------------------------

9 T2S Actors: Payment Bank (Scenario A)/Central Bank (Scenario B)

10 The Payment Bank [Central Bank] checks all the details related to liquidity transfer against the reference
 11 data (maintained by the Central Bank or Payment Bank) and may perform additional checks/validations.

12 **6.4.3.2 INITIATE LIQUIDITY TRANSFER IN T2S**

Reference ID	T2S.BPD.LQMG.INLT.02
---------------------	-----------------------------

13 T2S Actors: Payment Bank (Scenario A)/Central Bank (Scenario B)

1 The Payment Bank [Central Bank] enriches the liquidity transfer instruction with details required for transfer
 2 of liquidity within T2S and sends the liquidity transfer instruction to T2S via an A2A message or directly
 3 enters it using the T2S GUI (U2A).

4 References:

5 UDFS: Use Case “Send Immediate Liquidity Transfer” (Chapter 2.13)

6 GUI BFD: T2S.GUI.LMSE.INX.0040

7 **6.4.3.2.1 Enrich Liquidity Transfer Instruction**

Reference ID	T2S.BPD.LQMG.INLT.02.01
---------------------	--------------------------------

8 The Payment Bank [Central Bank] enriches the liquidity transfer instructions with specific information such
 9 as account numbers, amounts, etc. The Payment Bank [Central Bank] might want to use the query facilities
 10 in the RTGS system or T2S to get the necessary information.

11 **6.4.3.3 SEND INSTRUCTION TO T2S**

Reference ID	T2S.BPD.LQMG.INLT.02.02
---------------------	--------------------------------

12 The Payment Bank [Central Bank] converts the liquidity transfer enriched with specific information into the
 13 required message format and sends it to T2S.

14 The instruction of T2S is also possible via the T2S GUI.

15 The Payment Bank [Central Bank] sends the following message to T2S:

16 **Table 6-11: Messages to T2S [T2S.BPD.LQMG.OTBD.02.02]**

Message Name	ISO Code	To/From T2S	UDFS Chapter
LiquidityCreditTransfer	camt.050.001.03	To T2S	3.3.3.13

17 **6.4.3.4 T2S PROCESSING**

18 The **Liquidity Transfer Service (T2S.SD.LIM.010)** validates the instruction (LiquidityCreditTransfer) and
 19 initiates the settlement for the liquidity transfer. The result of the validation is communicated to the relevant
 20 parties via a status advice (Receipt). The **Settlement Posting Service (T2S.SD.SETT.050)** performs the
 21 provisioning and booking of the liquidity transfer instruction between the T2S dedicated cash accounts and
 22 triggers the posting notifications (BankToCustomerDebitCreditNotification). In addition this service
 23 communicates the fulfilled floor and/or ceiling conditions on the involved accounts to the relevant parties
 24 (Return Account) and confirms the liquidity transfer (Receipt).

1 **6.4.3.5 MANAGE LIQUIDITY TRANSFER RESULTS**

Reference ID	T2S.BPD.LQMG.OTBD.05
---------------------	-----------------------------

2 T2S Actors: Central Bank and Payment Bank (both scenarios)

3 The Central Bank and Payment Bank receive the liquidity transfer related messages from T2S and initiate
4 related internal processes.

5 Additionally, the central bank and Payment Bank can also query on the liquidity transfer details via T2S
6 GUI.

7 References:

8 UDFS: Use Case “Send Immediate Liquidity Transfer” (Chapter 2.13)

9 GUI BFD: T2S.GUILLMSE.INX.0010, T2S.GUILLMSE.INX.0020, T2S.GUILLMSE.INX.0030

10 **6.4.3.5.1 Receive Status Advice**

Reference ID	T2S.BPD.LQMG.OTBD.05.01
---------------------	--------------------------------

11 In case of Scenario A, the Payment Bank receives status advice messages for acceptance or rejection of the
12 liquidity transfer instruction within T2S. Following the message reception, other internal activities might be
13 conducted such as:

- 14 • aligning the status of the liquidity transfer instruction in its systems with the status in T2S,
- 15 • triggering notification to their relevant clients.

16 If T2S has been instructed via the T2S GUI the status is shown on the screen.

17 In case of Scenario B, the Central Bank receives the status advice messages.

18 The Payment Bank [Central Bank] receives the following message from T2S:

19 **Table 6-12: Messages from T2S [T2S.BPD.LQMG.OTBD.05.01]**

Message Name	ISO Code	To/From T2S	Event	UDFS Chapter
Receipt	camt.025.001.03	From T2S	Rejection or acceptance of an internal liquidity transfer	3.3.3.12

20

21

1 **6.4.3.6 RECEIVE NOTIFICATIONS**

Reference ID	T2S.BPD.LQMG.OTBD.05.02
---------------------	--------------------------------

2 In both scenarios, the Payment Bank receives posting notifications and potentially floor and ceiling
 3 notifications when the liquidity transfer is booked in T2S. Following the message reception, other internal
 4 activities might be conducted such as:

- 5 • aligning the status of the liquidity transfer instruction in the Payment Bank’s systems with the status in
 6 T2S,
- 7 • triggering notification to their relevant clients.

8 The Payment Bank receives the following messages from T2S:

9 **Table 6-13: Messages from T2S [T2S.BPD.LQMG.OTBD.05.02]**

Message Name	ISO Code	To/From T2S	Event	UDFS Chapter
Return Account	camt.004.001.05	From T2S	Cash balance after the posting on the T2S dedicated cash account is below the floor or above the ceiling thresholds set-up for the dedicated cash account	3.3.3.2
BankToCustomerDebitCreditNotificationV03	camt.054.001.03	From T2S	Confirmation of the debit or credit cash posting on a T2S dedicated cash account	3.3.3.17

10 **6.4.3.7 RECEIVE CONFIRMATIONS**

Reference ID	T2S.BPD.LQMG.OTBD.05.03
---------------------	--------------------------------

11 In case of Scenario A, the Payment Bank receives and validates settlement confirmations for the liquidity
 12 transfers sent by T2S.

13 Following the message reception, other internal activities might be conducted such as:

- 14 • aligning the status of the liquidity transfer instruction in the Central Bank or Payment Bank’s books with
 15 the status in T2S,
- 16 • triggering notification to their relevant clients.

- 1 In case of Scenario B, the Central Bank receives the confirmation message.
- 2 The Payment Bank [Central Bank] receives the following message from T2S:

3 **Table 6-14: Messages from T2S [T2S.BPD.LQMG.OTBD.05.03]**

Message Name	ISO Code	To/From T2S	Event	UDFS Chapter
Receipt	camt.025.001.03	From T2S	T2S informs the status of the liquidity transfer to the relevant Payment Banks	3.3.3.2

4

1 **6.5 END OF DAY CASH MANAGEMENT [T2S.BPD.LQMT.EODC]**

2 **6.5.1 OVERVIEW**

3 This process describes the End of Day Cash Management in T2S. A Central Bank and/or a Payment Bank
4 can have a dedicated cash account in T2S to facilitate securities settlement for itself or to its client(s) to
5 which it provides cash settlement services. For these purposes, a Payment Bank funds liquidity in its
6 dedicated cash account in T2S from a cash account in RTGS (either its own or its liquidity provider).
7 Securities settlement in T2S can involve the use of auto-collateralisation facilities between a Payment Bank
8 in T2S and its Central Bank. For every such auto-collateralisation, T2S generates the equivalent
9 reimbursement instructions and holds it for a future release from the Payment Bank, during the business day.

10 At the end of a T2S business day, T2S pe

11 rforms the following steps as part of cash management to retransfer all the cash from T2S to the RTGS. T2S
12 identifies this process as the “End of day cash management”.

- 13 • Release of all unused cash restrictions such as cash blockings, cash reservations and creation of
14 settlement restrictions for settlement on next business date in case of COSD cash blocking only).
- 15 • Reimbursement of any pending intraday credit provided by central banks to its Payment Banks.
- 16 • Optional cash sweep from T2S to RTGS via liquidity credit transfer after the completion of
17 reimbursement of auto-collateralisation (i.e. intraday credit by Central Banks).
- 18 • End of day liquidity transfers to retransfer all remaining cash from a T2S dedicated cash account/ central
19 bank cash account to its relevant linked RTGS account as there must be no overnight cash on DCAs at
20 the end of T2S settlement day.

21 **Trigger:**

- 22 • Completion of “DVP cut-off” and the “cash restriction cut-off” events in T2S for a defined currency and
23 the relevant Central Bank(s) receive related status information on T2S settlement day.
- 24 • The reimbursement of any pending intraday credit provided by central banks to its Payment Banks is
25 triggered at 4.30 p.m. CET.
- 26 • The end-of-day cash sweep is triggered at 5.45 p.m. CET in T2S.

27 This process starts when the “DVP cut-off” and the “cash restriction cut-off” completes in T2S. T2S initiates
28 the end-of-day cash management procedures as part of “real time settlement closure period” scheduled
29 between “real-time settlement period” and “end of day period”.

30

1 **Preconditions:**

- 2 • Central Bank and Payment Bank as CSD Participant(s) needs to have securities account(s) with its
 3 relevant CSD(s) to facilitate the end-of-day reimbursements and possible collateral relocations.
 4 • Central Bank must have defined the collateralisation procedure.

5 **T2S Instructing Party:**

6 There are two scenarios for the instruction of T2S:

- 7 • Scenario A: Central Bank instructs T2S.
 8 • Scenario B: Payment Bank instructs T2S.

9 **6.5.2 BUSINESS PROCESS DIAGRAM**

10 **Figure 6-7: Business Process Diagram [T2S.BPD.LQMT.EODC]**

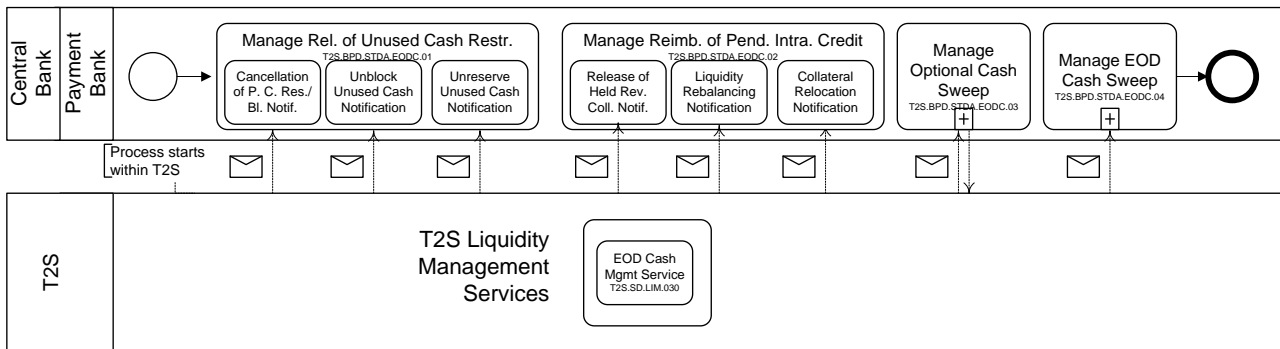

11
 12 The processes are depicted from the cash parties' perspective only.

13 The Central Bank pool includes the RTGS and Central Bank Management System.

14 **6.5.3 BUSINESS PROCESS DESCRIPTION**

15 **6.5.3.1 T2S PROCESSING**

16 The **End of day (EOD) cash management service (T2S.SD.LIM.030)** performs the end of day cash
 17 management related processes and activities in the order given below. For details on the T2S services
 18 involved in each step, please refer to the indicated business process.

- 19 • Release all remaining blocked cash - Unreservation or Unblocking of Cash Balance
 20 [T2S.BPD.SETT.UUCB].
 21 • Reimburse all pending intraday credit - Management of Auto- Collateralisation
 22 [T2S.BPD.SETT.ACOL].
 23 • Perform a cash sweep - Intraday Transfer of Liquidity from T2S to RTGS [T2S.BPD.LQMG.OTBD].

1 **6.5.3.2 MANAGE RELEASE OF UNUSED CASH RESTRICTIONS**

Reference ID	T2S.BPD.STDA.EODC.01
--------------	----------------------

2 T2S Actors: Central Bank (Scenario A)/Payment Bank (Scenario B)

3 This process starts when the “DVP cut-off” and “cash restriction cut-off” process completes in T2S and
 4 Central Bank receives the status notification for a settlement day.

5 The Central Bank [Payment Bank] receives messages from T2S as a result of the T2S internal processes
 6 related to the release of unused cash restrictions.

7 For details on the unreservation and unblocking of a cash balances refer to process “Unreservation or
 8 Unblocking of Cash Balance [T2S.BPD.SETT.UUCB]”.

9 References:

10 UDFS: Use Case “End-of-day cash management” (Chapter 2.17)

11 **6.5.3.2.1 Cancellation of Pending Cash Blockings/ Reservations Notifications**

Reference ID	T2S.BPD.STDA.EODC.01.01
--------------	-------------------------

12 The Central Bank [Payment Bank] receives the status advices for the cancellation of cash blockings/
 13 reservations which have a pending part and checks all the details related to such cash blockings/ reservations
 14 (with a restriction reference in T2S) and zero the pending balance in its books.

15 The Central Bank [Payment Bank] receives the following messages from T2S:

16 **Table 6-15: Messages from T2S [T2S.BPD.STDA.EODC.01.01]**

Message Name	ISO Code	To/From T2S	Event	UDFS Chapter
IntraBalanceMove mentStatusAdvice V01	Camt.067.001.01	From T2S	Status “Cancelled”	3.3.3.21

17 **6.5.3.2.2 Unblock Unused Cash Notifications**

Reference ID	T2S.BPD.STDA.EODC.01.02
--------------	-------------------------

18 The Central Bank [Payment Bank] receives the confirmations related to unblocking of cash (including
 19 COSD) in T2S, to update its books.

20 The Central Bank [Payment Bank] receives the following messages from T2S:

21

1 **Table 6-16: Messages from T2S [T2S.BPD.STDA.EODC.01.02]**

Message Name	ISO Code	To/From T2S	Event	UDFS Chapter
IntraBalanceMove mentConfirmation V01	Camt.068.001.01	From T2S	Status “Settlement”	3.3.3.22

2 **6.5.3.2.3 Un-reserve Unused Cash Notifications**

Reference ID	T2S.BPD.STDA.EODC.01.03
---------------------	--------------------------------

3 The Central Bank [Payment Bank] receives the confirmations of cash un-reservations in T2S, to update its
4 books.

5 The Central Bank [Payment Bank] receives the following messages from T2S:

6 **Table 6-17: Messages from T2S [T2S.BPD.STDA.EODC.01.03]**

Message Name	ISO Code	To/From T2S	Event	UDFS Chapter
IntraBalanceMove mentConfirmation V01	Camt.068.001.01	From T2S	Status “Settlement”	3.3.3.22

7 **6.5.3.3 MANAGE REIMBURSEMENT OF ANY PENDING INTRADAY CREDIT**

Reference ID	T2S.BPD.STDA.EODC.02
---------------------	-----------------------------

8 T2S Actors: Central Bank (Scenario A)/Payment Bank (Scenario B)

9 This process starts after 4.30 p.m. CET and when the “release of all unused cash restrictions” process
10 completes in T2S. Kindly note that all the movements of securities and/or cash in the above mentioned
11 process can occur on an “all-or-none” basis.

12 The Central Bank [Payment Bank] receives messages from T2S as a result of the T2S internal processes
13 related to the reimbursement of pending intraday credit.

14 For details on the management of auto-collateralisation, refer to process “Management of Auto-
15 Collateralisation [T2S.BPD.SETT.ACOL]”.

16 References:

17 UDFS: Use Case “End-of-day cash management” (Chapter 2.17)

18

1 **6.5.3.3.1 “Release” of Held Reverse Collateral Notifications**

Reference ID	T2S.BPD.STDA.EODC.02.01
---------------------	--------------------------------

2 The Central Bank [Payment Bank] receives the “release” confirmations of held reverse collateral instructions
 3 when T2S automatically releases these instructions related to any pending intraday credit in T2S.

4 The Central Bank [Payment Bank] can adjust its books on the reimbursement of the collaterals and cash
 5 when the reverse collateral instruction settles along with other movements, if any, referred in below sections.

6 The Central Bank [Payment Bank] receives the following messages from T2S:

7 **Table 6-18: Messages from T2S [T2S.BPD.STDA.EODC.02.01]**

Message Name	ISO Code	To/From T2S	Event	UDFS Chapter
SecuritiesSettlementTransactionStatusAdviceV03	Sese.024.001.03	From T2S	Status “No hold remains”	3.3.8.5

8 **6.5.3.3.2 “Liquidity Rebalancing” Notifications**

Reference ID	T2S.BPD.STDA.EODC.02.02
---------------------	--------------------------------

9 The Central Bank [Payment Bank] receives the “liquidity rebalancing” related posting notifications, alert
 10 notifications for floor/ ceiling violations, when T2S settles the movement of needed cash from other T2S
 11 DCAs of the same Payment Bank to the T2S DCA in need of cash to settle its reimbursements.

12 The Central Bank [Payment Bank] bank can adjust its books on the cash when the liquidity rebalancing
 13 related movements settles along with other movements, if any, referred in below sections.

14

1 The Central Bank [Payment Bank] receives the following messages from T2S:

2 **Table 6-19: Messages from T2S [T2S.BPD.STDA.EODC.02.02]**

Message Name	ISO Code	To/From T2S	Event	UDFS Chapter
BankToCustomerDebitCreditNotificationV03	Camt.054.001.03	From T2S	For “Debit notification”/ “Credit notification”	3.3.3.17
ReturnAccountV05	Camt.004.001.05	From T2S	For alert notification due to violation of floor/ ceiling limits	3.3.3.2

3 **6.5.3.3.3 “Collateral Relocation” Notifications**

Reference ID	T2S.BPD.STDA.EODC.02.03
---------------------	--------------------------------

4 The Central Bank [Payment Bank] receives the “collateral relocation” related generation notifications and its
 5 settlement confirmations, when T2S performs additional collateralisation as “collateral relocation” between
 6 the Central Bank and the Payment Bank equivalent to the cash drawn (i.e. intraday credit utilised) from the
 7 central bank cash account. T2S performs the additional collateralisation when the liquidity rebalancing
 8 process does not yield the needed cash to complete the reimbursement.

9 The below messages are sent by T2S when performing the “collateral relocation”. Additionally, T2S can
 10 send the one or more of the below messages for the purposes such as realignment also.

11 The Central Bank [Payment Bank] receives the following messages from T2S:

12 **Table 6-20: Messages from T2S [T2S.BPD.STDA.EODC.02.03].**

Message Name	ISO Code	To/From T2S	Event	UDFS Chapter
SecuritiesSettlementTransactionGenerationNotificationV03	Sese.032.001.03	From T2S	Generation of “Collateral” relocation instruction	3.3.8.13
SecuritiesSettlementTransactionConfirmationV03	Sese.025.001.03	From T2S	“Settlement” of the generated collateral relocation instruction in case of repo/ pledge model	3.3.8.6
SecuritiesSettlementTransactionStatusAdviceV03Securiti	Sese.024.001.0303	From T2S	For “partial settlement	3.3.8.5

Message Name	ISO Code	To/From T2S	Event	UDFS Chapter
esSettlementTransactionStatusAdvice V03			(unsettled part)”	
IntraPositionMovementConfirmation V03	Semt.015.001.03	From T2S	“Settlement” of the generated collateral relocation instruction in case of pledge-sub model	3.3.7.4

- 1 The intraday credit utilised in T2S is translated into the equivalent intraday credit utilisation in the RTGS for
 2 the relevant Payment Bank, with the following activities:
- 3 • the collateral mobilisation related processes in CMS to identify Payment Banks involved and process
 4 collateral relocation settlement confirmations from T2S,
 - 5 • inform relevant RTGS for intraday credit utilisation updates for the respective Payment Bank.

6 **6.5.3.4 MANAGE OPTIONAL CASH SWEEP**

Reference ID	T2S.BPD.STDA.EODC.03
--------------	----------------------

7 T2S Actors: Central Bank (Scenario A)/Payment Bank (Scenario B)

8 The process steps to execute an optional cash sweep in T2S are same as the process steps to execute the
 9 “multiple liquidity provider” facility. This process depends on the setup of the “standing liquidity transfer
 10 orders” by the relevant Payment Bank. These liquidity transfers are setup to be processed, at the completion
 11 of automatic reimbursement of central auto-collateralisation to its payment banks.

12 The Central Bank [Payment Bank] receives the posting notifications and alert notifications for violation of
 13 floor/ ceiling limits during every cash sweep.

14 For details on the multiple liquidity provider transfers of liquidity taking place at the end of night-time
 15 settlement, refer to process “Multiple Liquidity Provider Transfer of Liquidity from T2S to RTGS
 16 [T2S.BPD.LQMG.MLPT]”.

17

1 The Central Bank [Payment Bank] receives the following messages from T2S:

2 **Table 6-21: Messages from T2S [T2S.BPD.STDA.EODC.03]**

Message Name	ISO Code	To/From T2S	Event	UDFS Chapter
LiquidityCreditTransferV03	Camt.050.001.03	From T2S	“Settlement” of generated liquidity credit transfer in T2S	3.3.3.13
ReceiptV03	Camt.025.001.03	From T2S	Receipt of an RTGS Answer by T2S (to the outbound liquidity transfer sent from T2S to RTGS), As an information to the Central Bank when the RTGS sends an “invalid” or a “rejection” as an RTGS Answer	3.3.3.12
ReturnAccountV05	camt.004.001.05	From T2S	Floor or a ceiling violation when a cash posting occurs on a T2S dedicated cash account	3.3.3.2
BankToCustomerDebitCreditNotificationV03	camt.054.001.03	From T2S	Confirmation of the debit or credit cash posting on a T2S dedicated cash account	3.3.3.17

3 **6.5.3.5 MANAGE END-OF-DAY CASH SWEEP**

Reference ID	T2S.BPD.STDA.EODC.04
--------------	----------------------

4 T2S Actors: Central Bank (Scenario A)/Payment Bank (Scenario B)

5 The “end-of-day” cash sweep starts at 5.45 p.m. CET in T2S. The process steps to execute end-of-day cash
 6 sweep in T2S are same as the process steps to execute “Multiple liquidity provider” facility with the
 7 difference that the liquidity transfer generated in T2S depends on the end-of-day link configured on the T2S
 8 dedicated cash account. This liquidity transfer can be of two types:

- 9 • A liquidity credit transfer for a transfer of any positive cash balance from a T2S DCA to its linked RTGS
 10 account,

- 1 • A liquidity debit transfer for a transfer of any negative cash balance from the central bank cash account
- 2 to its linked RTGS account.
- 3 The Central Bank [Payment Bank] receives posting notifications and alert notifications for violation of floor/
- 4 ceiling limits during processing of every such liquidity transfer.
- 5 For details on the multiple liquidity provider transfers of liquidity taking place at the end of night-time
- 6 settlement, refer to process “Multiple Liquidity Provider Transfer of Liquidity from T2S to RTGS
- 7 [T2S.BPD.LQMG.MLPT]”.

8 **Table 6-22: Messages from T2S [T2S.BPD.STDA.EODC.04]**

Message Name	ISO Code	To/From T2S	Event	UDFS Chapter
LiquidityCreditTransferV03	Camt.050.001.03	From T2S	“Settlement” of generated liquidity credit transfer in T2S	3.3.3.13
ReceiptV03	Camt.025.001.03	From T2S	Receipt of an RTGS Answer by T2S (to the outbound liquidity transfer sent from T2S to RTGS), As an information to the Central Bank when the RTGS sends an “invalid” or a “rejection” as an RTGS Answer	3.3.3.12
ReturnAccountV05	camt.004.001.05	From T2S	Floor or a ceiling violation when a cash posting occurs on a T2S dedicated cash account	3.3.3.2
BankToCustomerDebitCreditNotificationV03	camt.054.001.03	From T2S	Confirmation of the debit or credit cash posting on a T2S dedicated cash account	3.3.3.17

1 7. STATIC DATA MAINTENANCE PROCESSES

2 7.1 MAINTENANCE OF SECURITIES [T2S.BPD.STDA.MSEC]

3 7.1.1 OVERVIEW

4 This process describes the act of creating, updating and deleting securities static data in T2S. The Securities
5 Reference Data stores information about securities in T2S. This business object stores a standardised set of
6 details required for settlement and auto-collateralisation in T2S only. T2S allows CSDs to store additional
7 market-specific attributes for each security¹⁰⁷. The market-specific attributes can be included in reports for
8 informational purpose or used for set-up of processing rules. The Securities Reference Data consists of the
9 securities name, ISIN code and other essential information required for settlement processing in T2S (e.g.
10 issuance date, maturity date, settlement unit multiple, etc).

11 The Securities Reference Data in T2S is required for processes such as validation of incoming settlement
12 instructions, inclusion in reports generated by T2S and set-up of processing restrictions in T2S based on
13 specific attributes of the securities.

14 The Securities Reference Data business object is referenced by the T2S business validation service in
15 business processes that make use of the core settlement services of T2S (e.g. intra and cross CSD
16 settlements) as well as in other business processes that depend on the static data stored in T2S (e.g. securities
17 lending and borrowing, pledge).

18 After the CSD acting as a Securities Maintaining Entity has set-up a new security (or with a change of
19 security, i.e. change of ISIN code¹⁰⁸), other CSDs can make the security available for settlement for its CSD
20 Participants (description may be found in the business process on the Maintain Cross-CSD Settlement Link
21 and Securities Eligibility).

22 In addition, Central Banks can make the security eligible for auto-collateralisation for its Payment Banks and
23 provide a price for the new security (description may be found in the business process on Maintenance of
24 Securities Valuation).

25 The securities maintenance process includes all technical activities to maintain the static data information of
26 a security, (i.e. creation, update, and deletion of securities reference data) depending on whether the data

¹⁰⁷ Market-specific attributes defined by a CSD (independently of whether the CSD is a Securities Maintaining Entity for the Security or not) are only accessible for this CSD.

¹⁰⁸ Only T2S operator can maintain it in case of input error by the responsible CSD when creating the security)

1 already exists and the intended result. It is possible for non-SME CSDs to update the securities reference
 2 data, e.g. to maintain their Market Specific Attributes and to maintain Intra-day restrictions.

3 **Trigger:**

4 CSD receives a maintenance request of a security from its CSD Participant, a CSD in T2S or a third party
 5 (issuer, agent of the issuer).

6 **Preconditions:**

7 None

8 **T2S Instructing Party:**

9 CSD

10 **7.1.2 BUSINESS PROCESS DIAGRAM**

11 **Figure 7-1: Business Process Diagram [T2S.BPD.STDA.MSEC]**

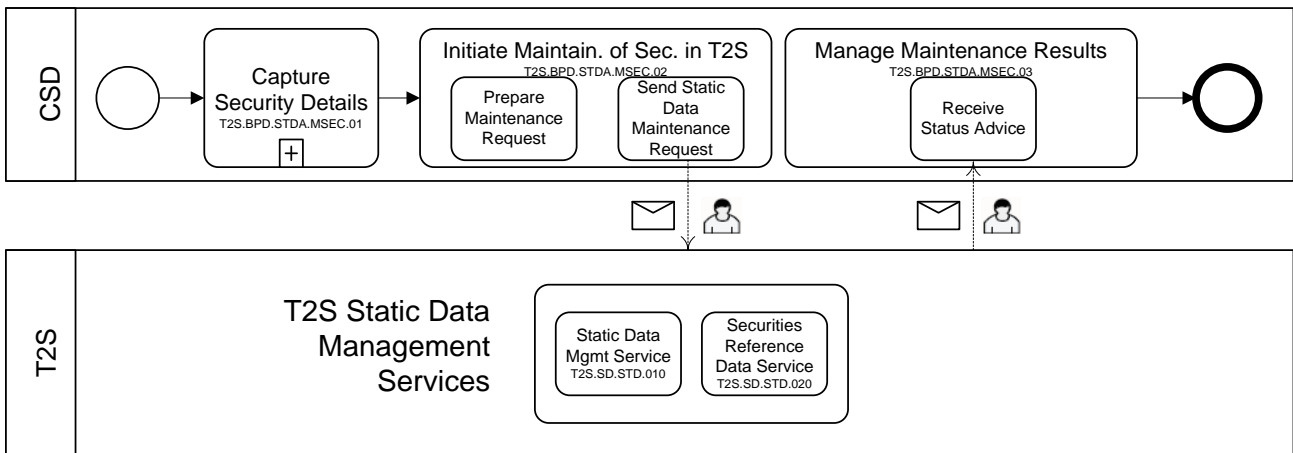

13 **7.1.3 BUSINESS PROCESS DESCRIPTION**

14 **7.1.3.1 CAPTURE SECURITY DETAILS**

Reference ID	T2S.BPD.STDA.MSEC.01
--------------	----------------------

15 T2S Actors: CSD

16 The CSD collects maintenance details of the securities from the issuer, market data vendors, or other market
 17 intermediaries providing information on the securities reference data.

18 The CSD may also conduct more steps such as validation and comparison of data received from multiple
 19 sources to produce the master copy of the securities reference data.

1 **7.1.3.2 INITIATE MAINTENANCE OF SECURITIES IN T2S**

Reference ID	T2S.BPD.STDA.MSEC.02
--------------	----------------------

2 T2S Actors: CSD

3 The CSD uses the securities details previously captured to create a maintenance instruction (i.e. Security
4 Creation Request, Security Maintenance Request or Security Deletion Request) for T2S and sends the
5 instruction to T2S.

6 References:

7 UDFS: Use Case “Maintain SD” (Chapter 2.20)

8 GUI BFD: T2S.GUI.SDSE.SEC.0060, T2S.GUI.SDSE.SEC.0040, T2S.GUI.SDSE.SEC.0050

9 **7.1.3.2.1 Prepare Maintenance Request**

Reference ID	T2S.BPD.STDA.MSEC.02.01
--------------	-------------------------

10 The CSD collects the securities maintenance details and prepares the securities maintenance instruction.

11 *Creation of new securities*

12 The creation of securities reference data is performed by a CSD. By creating new security reference data in
13 T2S this CSD does not become a Securities Maintaining Entity for this security automatically (the process to
14 become a Securities Maintaining Entity is described in the business process on the Maintain Cross-CSD
15 Settlement Link and Securities Eligibility).

16 Securities can be created intraday wherein the issuance date can be in the past, current business date or a
17 future business date.

18 If a CSD defined mandatory market specific attributes, then they must be included in the request for set-up of
19 new securities in T2S. The CSD could include optional market specific attributes as well in any case.

20 *Amendment of securities reference data*

21 The CSD that has the role of the Securities Maintaining Entity for a security can update the security’s
22 reference data and add/amend market-specific attributes for its own use.

23 The CSD that has not the role of the Securities Maintaining Entity for a security can only add/amend market-
24 specific attributes for its own use.

25 The Security Maintenance Request can be sent intraday only as of a future business date. For updates of the
26 minimum and multiple settlement unit, of the deviating settlement units and of the settlement type the
27 request cannot be sent intraday unless the update applies to a security created on the current settlement day

1 or the security is not eligible for auto-collateralisation since the start of day. For the before mentioned
 2 updates and those related to the Final Maturity/Expiry Date, the static data maintenance will be queued and
 3 then resumed and completed at the End of Day phase (daytime) or end of sequence (night time). If needed,
 4 the queued static data maintenance request might be revoked via GUI (followed by a new update request)
 5 and will be processed without having to wait for T2S to resume and complete it.

6 Modification of Securities reference data might trigger a revalidation of all pending settlement instructions.
 7 If a blocked restriction applying on a Security is removed by the CSD intraday (or the validity is ended), T2S
 8 will recycle the transactions previously considered ineligible because of the blocking. If a new blocked
 9 restriction is created, T2S will make the relevant transactions ineligible when the blocking becomes active.

10 *Deletion of securities*

11 The CSD that has the role of the Securities Maintaining Entity for a security can perform the logical deletion
 12 of the security’s reference data.

13 A logical deletion of securities reference data is only allowed for a future business date, if the maturity date
 14 is in the past.

15 The CSD can restore a deleted Security.

16 **7.1.3.2.2 Send Static Data Maintenance Request**

Reference ID	T2S.BPD.STDA.MSEC.02.02
--------------	-------------------------

17 The CSD formats the maintenance instruction depending upon the type of maintenance action (i.e. create,
 18 update or delete) with T2S specific securities reference data and sends the maintenance instruction to the
 19 T2S.

20 The instruction of T2S is also possible via the T2S GUI.

21 The CSD sends the following message to T2S:

22 *For creation of security reference data*

23 **Table 7-1: Messages to T2S [T2S.BPD.STDA.MSEC.02.02/Creation]**

Message Name	ISO Code	To/From T2S	UDFS Chapter
SecurityCreationRequest V01	Reda.006.001.01	To T2S	3.3.6.1

24 *For amendment of securities reference data*

1 **Table 7-2: Messages to T2S [T2S.BPD.STDA.MSEC.02.02/Amendment]**

Message Name	ISO Code	To/From T2S	UDFS Chapter
SecuritiesMaintenanceRequestV01	Reda.007.001.01	To T2S	3.3.6.2

2

3

1 *For deletion of securities reference data*

2 **Table 7-3: Messages to T2S [T2S.BPD.STDA.MSEC.02/Deletion]**

Message Name	ISO Code	To/From T2S	UDFS Chapter
SecuritiesDeletionRequestV01	Reda.013.001.01	To T2S	3.3.6.7

3 **7.1.3.3 T2S PROCESSING**

4 The **Static Data Management Service (T2S.SD.STD.010)** validates the incoming request
 5 (SecurityCreationRequestV01 or SecuritiesMaintenanceRequestV01 or SecuritiesDeletionRequestV01). The
 6 **Securities Reference Data Service (T2S.SD.STD.020)** triggers the creation/update/deletion of the securities
 7 reference data and informs about the results (SecurityCreationStatusAdviceV01 or
 8 SecuritiesMaintenanceStatusAdviceV01 or SecuritiesDeletionStatusAdviceV01).

9 **7.1.3.4 MANAGE MAINTENANCE RESULTS**

Reference ID	T2S.BPD.STDA.MSEC.03
--------------	----------------------

10 The CSD receives status advice messages from T2S.

11 **7.1.3.4.1 Receive Securities Maintenance Instruction Status Advice**

12 The CSD receives the securities maintenance instruction status advice and may trigger other internal
 13 activities such as update of the CSD system, amend the securities maintenance instruction, define itself as
 14 Security Maintenance Entity if required, define eligible counterpart CSDs for the security in T2S, and trigger
 15 notification to its participants or start sending settlement instructions for a newly created security.

16 If T2S has been instructed via the T2S GUI the status is shown on the screen.

17 The CSD receives the following message from T2S:

18 *For creation of reference data*

19 **Table 7-4: Messages from T2S [T2S.BPD.STDA.MSEC.03/Creation]**

Message Name	ISO Code	To/From T2S	Event	UDFS Chapter
SecurityCreationStatusAdviceV01	Reda.008.001.01	From T2S	Maintenance request is “queued”, “rejected” or “completed”	3.3.6.3

20

21

1 *For amendment of securities reference data*

2 **Table 7-5: Messages from T2S [T2S.BPD.STDA.MSEC.03/Amendment]**

Message Name	ISO Code	To/From T2S	Event	UDFS Chapter
SecuritiesMaintenanceStatusAdviceV01	Reda.029.001.01	From T2S	Maintenance request is “queued”, “rejected” or “completed”	3.3.6.23

3 *For deletion of securities reference data*

4 **Table 7-6: Messages from T2S [T2S.BPD.STDA.MSEC.03/Deletion]**

Message Name	ISO Code	To/From T2S	Event	UDFS Chapter
SecuritiesDeletionStatusAdviceV01	Reda.030.001.01	From T2S	Maintenance request is “queued”, “rejected” or “completed”	3.3.6.24

5

1 7.2 MAINTENANCE OF SECURITIES ACCOUNT [T2S.BPD.STDA.MSAC]

2 7.2.1 OVERVIEW

3 This process describes the act of creating, updating and deleting T2S Securities Account Reference Data
4 required for processing and booking operations in T2S. T2S allows CSDs to store additional market-specific
5 attributes for each security account. The market-specific attributes can be included in reports for
6 informational purpose or used for setting-up processing rules.

7 The Securities Account Reference Data in T2S is required for processes such as validation of incoming
8 settlement instructions and set-up of processing restrictions in T2S based on specific attributes of the
9 securities account. The data can be retrieved via the T2S GUI (U2A) or via A2A queries and reports.

10 The Securities Account Reference Data business object is referenced by the T2S business validation service
11 in business processes that make use of the core settlement services of T2S (e.g. intra and cross CSD
12 settlements) as well as in other business processes that depend on the static data stored in T2S.

13 Each T2S Securities Account is attributed legally and technically to only one CSD. The T2S Securities
14 Account concept covers all types of securities accounts (e.g. issuance account, mirror account, omnibus
15 account).

16 The securities account maintenance process includes all technical activities to maintain the static data
17 information of a security account, (i.e. creation, update, and deletion of securities account reference data)
18 depending on whether the data already exists and what the intended result is.

19 **Trigger:**

20 CSD receives a request for maintaining a security account.

21 **Preconditions:**

22 None

23 **T2S Instructing Party:**

24 CSD

1 **7.2.2 BUSINESS PROCESS DIAGRAM**

2 **Figure 7-2: Business Process Diagram [T2S.BPD.STDA.MSAC]**

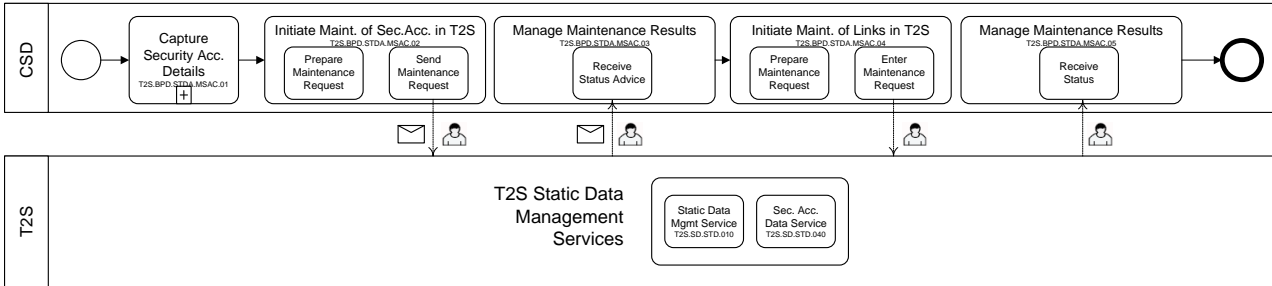

4 **7.2.3 BUSINESS PROCESS DESCRIPTION**

5 **7.2.3.1 CAPTURE SECURITIES ACCOUNT DETAILS**

Reference ID	T2S.BPD.STDA.MSAC.01
--------------	----------------------

6 T2S Actors: CSD

7 The CSD collects the securities account data that T2S requires for creating or updating a securities account in
 8 T2S. The Securities account data¹⁰⁹ includes:

- 9 • securities account details (securities account number, account type, negative position, opening/closing
 10 dates, hold and release default, End Investor Account Flag),
 11 • CSD/CSD Participant that owns the Securities Account,
 12 • securities account restrictions: the earmarking, ~~or~~ blocking, or rejection at validation level (insolvency
 13 procedure), if any,
 14 • T2S Dedicated Cash Account(s) to which the securities account should be linked, if any,
 15 • market-specific attributes if applicable,
 16 • pricing scheme to be applied (by account or ISIN).

17 **7.2.3.2 INITIATE MAINTENANCE OF SECURITIES ACCOUNT IN T2S**

Reference ID	T2S.BPD.STDA.MSAC.02
--------------	----------------------

18 T2S Actors: CSD

¹⁰⁹ Further information about the description of the attributes for a securities account reference data may be found in the T2S User Requirements Document (requirement T2S.16.590)

1 The CSD uses the securities account details from the data received in the Capture Securities Account Details
 2 step to create a maintenance instruction (i.e. Security Account Creation Request, Security Account
 3 Maintenance Request or Security Account Deletion Request) for T2S and sends the instruction to T2S.

4 This holds true for all the securities account details except for the T2S Dedicated cash account(s) to which
 5 the securities account is linked. Maintenance of the links to the T2S dedicated cash accounts is initiated in a
 6 separate step “Maintenance of link between Securities and Cash Accounts” (T2S.BPD.STDA.MSAC.04).

7 References:

8 UDFS: Use Case “Maintain SD” (Chapter 2.20)

9 GUI BFD: T2S.GUI.SDSE.SAC.0070, T2S.GUI.SDSE.SAC.0040, T2S.GUI.SDSE.SAC.0050,
 10 T2S.GUI.SDSE.SAC.0060

11 **7.2.3.2.1 Prepare Maintenance Request**

Reference ID	T2S.BPD.STDA.MSAC.02.01
--------------	-------------------------

12 The CSD collects the securities account maintenance details and prepares the securities account maintenance
 13 instruction.

14 *Creation of new securities account*

15 Securities account can be created as of the current or a future business day (i.e. the opening date can be
 16 current business date).

17 If the CSD defined any mandatory market specific attributes, then the related values must be included in the
 18 creation request to T2S. The CSD could include optional market specific attributes as well in any case.

19 *Amendment of securities account reference data*

20 The CSD, to which the security account belongs, can update the securities account’s reference data.

21 Modification of Securities account reference data might trigger revalidation of all pending settlement
 22 instructions.

23 If a blocked restriction applying on a Security Account is removed by the CSD intraday (or the validity is
 24 ended), T2S will recycle the transactions previously considered ineligible because of the blocking. If a new
 25 blocked restriction is created, T2S will make the relevant transactions ineligible when the blocking becomes
 26 active.

27 If a rejection restriction is applied on a Security Account, any settlement instruction debiting the insolvent
 28 account will be rejected. Instructions already in the system would not be automatically cancelled.

29

1 The CSD can update the relationship between a CSD Participant and a Securities Account in the T2S GUI
2 (U2A) only¹¹⁰.

3

¹¹⁰ Change of party securities account relationship in T2S may be used as a mechanism by CSD and custodian banks to affect portfolio transfers.

1 *Deletion of securities account*

2 The CSD, to which the security account belongs, can perform a (logical) deletion of the securities account.
 3 Before requesting a deletion, the CSD could check whether there was any pending instruction on this account
 4 by a query (see BPD on Queries).

5 A (logical) deletion of the securities account is only allowed as of a future business date. In addition the
 6 securities accounts must be closed.

7 The CSD can restore a deleted Securities Account.

8 **7.2.3.2.2 Send Request to T2S**

Reference ID	T2S.BPD.STDA.MSAC.01.02
--------------	-------------------------

9 The CSD formats the maintenance instruction depending upon the type of maintenance action (i.e. create,
 10 update or delete) with T2S specific securities account reference data and sends the maintenance instruction to
 11 T2S.

12 The instruction of T2S is also possible via the T2S GUI.

13 The CSD sends the following message to T2S:

14 *For creation of reference data*

15 **Table 7-7: Messages to T2S [T2S.BPD.STDA.MSAC.01.02/Creation]**

Message Name	ISO Code	To/From T2S	UDFS Chapter
SecuritiesAccountCreationRequestV01	Reda.018.001.01	To T2S	3.3.6.12

16 *For amendment of securities account reference data*

17 **Table 7-8: Messages to T2S [T2S.BPD.STDA.MSAC.01.02/Amendment]**

Message Name	ISO Code	To/From T2S	UDFS Chapter
SecuritiesAccountModificationRequestV01	Reda.023.001.01	To T2S	3.3.6.17

18

1 *For deletion of securities account reference data*

2 **Table 7-9: Messages to T2S [T2S.BPD.STDA.MSAC.01.02/Deletion]**

Message Name	ISO Code	To/From T2S	UDFS Chapter
SecuritiesAccountDeletionRequestV01	Reda.032.001.01	To T2S	3.3.6.26

3 **7.2.3.3 T2S PROCESSING**

4 The **Static Data Management Service (T2S.SD.STD.010)** validates the incoming request
 5 (SecuritiesAccountCreationRequestV01 or SecuritiesAccountModificationRequestV01 or
 6 SecuritiesAccountDeletionRequestV01). The **Securities Account Data Service (T2S.SD.STD.040)** triggers
 7 the creation/update/deletion of the securities account reference data and informs about the results
 8 (SecuritiesAccountStatusAdviceV01).

9 **7.2.3.4 MANAGE MAINTENANCE RESULTS OF SECURITIES ACCOUNT**

Reference ID	T2S.BPD.STDA.MSAC.03
--------------	----------------------

10 T2S Actors: CSD

11 The CSD receives the status advice from T2S, which might trigger other internal activities.

12 **7.2.3.4.1 Receive Status Advice**

Reference ID	T2S.BPD.STDA.MSAC.03.01
--------------	-------------------------

13 The CSD receives the status advices informing about the processing results of the securities account
 14 maintenance instruction.

15 If T2S has been instructed via the T2S GUI the status is shown on the screen.

16 This may trigger other internal activities such as updates in the CSD system, amendment of the securities
 17 account maintenance instruction, notification to its participants or free-of-payment settlement instructions for
 18 a newly created securities account as well as definition of CSD Account links for the securities account in
 19 T2S.

20

1 The CSD receives the following message from T2S:

2 For maintenance of securities account reference data

3 **Table 7-10: Messages from T2S [T2S.BPD.STDA.MSAC.03.01]**

Message Name	ISO Code	To/From T2S	Event	UDFS Chapter
SecuritiesAccountS tatusAdviceV01	Reda.020.001.01	From T2S	Maintenance request is “queued”, “rejected” or “completed”	3.3.6.14

4 **7.2.3.5 INITIATE MAINTENANCE OF LINK BETWEEN SECURITIES AND CASH**
 5 **ACCOUNTS**

Reference ID	T2S.BPD.STDA.MSAC.04
--------------	----------------------

6 T2S Actors: CSD

7 After the creation of a new Securities Account, the CSD uses the data received in the Capture Securities
 8 Account Details process or subsequent request from a CSD Participant to create or update links between the
 9 Securities Account and T2S Dedicated Cash Accounts. The update or creation of this link is possible in the
 10 T2S GUI (U2A) as well as in A2A.

11 The link between a Security Account and a Dedicated Cash Account is used by:

- 12 • A payment bank for cash settlement purposes,
- 13 • A credit receiver to specify the Security Account from which T2S takes the securities in a
 14 collateralisation operation when there is a lack of cash of the linked Dedicated Cash Account,
- 15 • A credit provider to indicate the Securities Account (i.e. regular collateral account or auto-
 16 collateralisation account) to which the securities have to be moved in a collateralisation operation
 17 when there is a lack of cash of the linked Dedicated Cash Account.

18 A pre-requisite for this process is the definition of party BIC(s) eligible to use the T2S Dedicated Cash
 19 Account for cash settlement purposes. The Central Bank owning the T2S Dedicated Cash Account is
 20 responsible for the maintaining the list of party BIC(s) in T2S static data.

21 References:

22 GUI BFD: T2S.GUI.SDSE.SAC.0040

23

1 **7.2.3.5.1 Prepare Maintenance Request**

Reference ID	T2S.BPD.STDA.MSAC.04.01
--------------	-------------------------

2 The CSD prepares the account link creation/maintenance request depending on the type of maintenance
 3 action (i.e. create, update or delete).

4 **7.2.3.5.2 Enter Request to T2S**

Reference ID	T2S.BPD.STDA.MSAC.04.02
--------------	-------------------------

5 The CSD formats the create/maintenance request and sends the instruction to T2S.

6 The instruction of T2S is also possible via the T2S GUI.

7 The CSD sends the following message to T2S:

8 *For creation of account link*

9 **Table 7-11: Messages to T2S [T2S.BPD.STDA.MSAC.04.02/Creation]**

Message Name	ISO Code	To/From T2S	UDFS Chapter
AccountLinkCreationRequestV01	Reda.049.001.01	To T2S	3.3.6.42

10 *For maintenance of account link*

11 **Table 7-12: Messages to T2S [T2S.BPD.STDA.MSAC.04.02/Maintenance]**

Message Name	ISO Code	To/From T2S	UDFS Chapter
AccountLinkMaintenanceRequestV01	Reda.050.001.01	To T2S	3.3.6.43

12 **7.2.3.6 MANAGE MAINTENANCE RESULTS OF LINK**

Reference ID	T2S.BPD.STDA.MSAC.05
--------------	----------------------

13 T2S Actors: CSD

14 The CSD receives the status advices informing about the processing results of the account link
 15 creation/maintenance request.

16 If T2S has been instructed via the T2S GUI the status is shown on the screen.

17 The result may trigger other internal activities such as update of the CSD system, trigger notification to its
 18 participants or start sending against payment settlement instructions.

19

1 **Table 7-13: Messages from T2S [T2S.BPD.STDA.MSAC.03.01]Message**

Name	ISO Code	To/From T2S	Event	UDFS Chapter
AccountLinkStatus AdviceV01	Reda.051.001.01	From T2S	Creation/Maintenance request is “queued”, “rejected” or “completed”	3.3.6.51

2

1 **7.3 MAINTENANCE OF CSD PARTICIPANT [T2S.BPD.STDA.MPTY]**

2 **7.3.1 OVERVIEW**

3 This process describes the act of creating, updating and deleting CSD Participant Reference Data in T2S.

4 The CSD Participant Reference Data in T2S is required for the usage of any securities-related services in
5 T2S e.g. cash services, securities settlement and auto-collateralisation in central bank money. T2S allows
6 CSDs to store additional market-specific attributes for each CSD Participant. The market-specific attributes
7 can be included in reports for informational purpose or used for set-up of processing rules.

8 The data can be retrieved via the T2S GUI (U2A) or via A2A queries and reports.

9 Each CSD Participant is attributed legally and technically to only one CSD.

10 The CSD Participant maintenance process includes all technical activities to maintain the static data
11 information of a CSD Participant, (i.e. creation, update, and deletion of CSD Participant reference data).

12 **Trigger:**

13 CSD receives a request for maintaining a CSD Participant details in T2S.

14 **Preconditions:**

15 None

16 **T2S Instructing Party:**

17 CSD

18 **7.3.2 BUSINESS PROCESS DIAGRAM**

19 **Figure 7-3: Business Process Diagram [T2S.BPD.STDA.PTYC]**

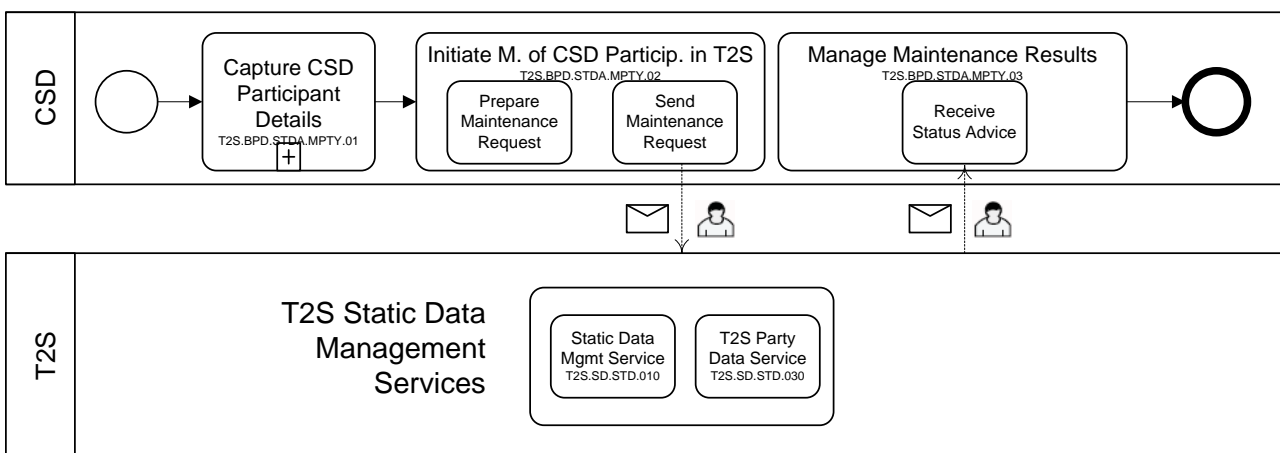

20

1 **7.3.3 BUSINESS PROCESS DESCRIPTION**

2 **7.3.3.1 CAPTURE CSD PARTICIPANT DETAILS**

Reference ID	T2S.BPD.STDA.MPTY.01
--------------	----------------------

3 T2S Actors: CSD

4 The CSD collects the CSD Participant data that T2S requires for creating or updating and deleting a CSD
 5 Participant in T2S upon request of the CSD Participant. The CSD Participant data¹¹¹ includes:

- 6 • CSD Participant details with its related validity start (short and long name with Valid from Date, party
 7 code, address, technical address, opening/closing dates, “CSD Participant” as party type),
- 8 • Market-specific attributes if applicable,
- 9 • Restriction details, if the Payment Bank has to be block or unblock and its validity period.

10 **7.3.3.2 INITIATE MAINTENANCE OF CSD PARTICIPANT IN T2S**

Reference ID	T2S.BPD.STDA.MPTY.02
--------------	----------------------

11 T2S Actors: CSD

12 The CSD uses the CSD Participant details from the data gathered in the Capture CSD Participant Details
 13 process to create a maintenance instruction (i.e. CSD Participant Creation Request, CSD Participant
 14 Maintenance Request or CSD Participant Deletion Request) for T2S and sends the instruction to T2S.

15 References:

16 UDFS: Use Case “Maintain SD” (Chapter 2.20)

17 GUI BFD: T2S.GUL.SDSE.PTY.0010, T2S.GUL.SDSE.PTY.0020, T2S.GUL.SDSE.PTY.0030,
 18 T2S.GUL.SDSE.PTY.0040, T2S.GUL.SDSE.PTY.0050, T2S.GUL.SDSE.PTY.0060

19 **7.3.3.2.1 Prepare Maintenance Request**

Reference ID	T2S.BPD.STDA.MPTY.02.01
--------------	-------------------------

20 The CSD prepares the CSD Participant maintenance instruction.

21 *For creation of CSD Participant reference data*

22 CSD Participant can be created as of the current or a future business day (i.e. the opening date can be current
 23 business date).

¹¹¹ Further information about the description of the attributes for Party Reference Data may be found in the T2S User Requirements Document (requirement T2S.16.550)

1 If a CSD defined mandatory market specific attributes, then they must be included in the request for set-up of
 2 new CSD Participant in T2S. The CSD could include optional market specific attributes as well in any case.

3 *For amendment of CSD Participant reference data*

4 The CSD, to which the CSD Participant belongs, can update the CSD Participant’s reference data.

5 Modification of CSD Participant’s reference data might trigger a revalidation of the relevant pending
 6 settlement instructions.

7 If a blocked restriction applying on a CSD Participant is removed by the CSD intraday (or the validity is
 8 ended), T2S will recycle the transactions previously considered ineligible because of the blocking. If a new
 9 blocked restriction is created, T2S will make the relevant transactions ineligible when the blocking becomes
 10 active.

11 In order to amend a CSD Participant in U2A, the CSD has to query it first.

12 *For deletion of CSD Participant reference data*

13 The CSD, to which the CSD Participant belongs, can perform a (logical) deletion of the CSD Participant.

14 A (logical) deletion of the CSD Participant is only allowed if the validity of the CSD Participant is closed
 15 and there is no link with a Securities Account, Security CSD Link and CSD Account Link.

16 The CSD can restore a deleted CSD Participant.

17 In order to delete a CSD Participant in U2A, the CSD has to query it first.

18 **7.3.3.2.2 Send Request to T2S**

Reference ID	T2S.BPD.STDA.MPTY.01.02
--------------	-------------------------

19 The CSD formats the maintenance instruction depending upon the type of maintenance action (i.e. create,
 20 update or delete) with T2S specific CSD Participant reference data and sends the maintenance instruction to
 21 T2S.

22 The instruction of T2S is also possible via the T2S GUI.

23 The CSD sends the following message to T2S:

24 *For creation of CSD Participant reference data*

25 **Table 7-14: Messages to T2S [T2S.BPD.STDA.MPTY.01.02/Creation]**

Message Name	ISO Code	To/From T2S	UDFS Chapter
PartyCreationRequestV0 1	reda.014.001.01	To T2S	3.3.6.8

1 For amendment of CSD Participant reference data

2 **Table 7-15: Messages to T2S [T2S.BPD.STDA.MPTY.01.02/Amendment]**

Message Name	ISO Code	To/From T2S	UDFS Chapter
PartyModificationRequestV01	reda.022.001.01	To T2S	3.3.6.16

3 For deletion of CSD Participant reference data

4 **Table 7-16: Messages to T2S [T2S.BPD.STDA.MPTY.01.02/Deletion]**

Message Name	ISO Code	To/From T2S	UDFS Chapter
PartyDeletionRequestV01	reda.031.001.01	To T2S	3.3.6.25

5 **7.3.3.3 T2S PROCESSING**

6 The **Static Data Management Service (T2S.SD.STD.010)** validates the incoming request
 7 (PartyCreationRequestV01 or PartyModificationRequestV01 or PartyDeletionRequestV01). The **T2S Party**
 8 **Data Service (T2S.SD.STD.030)** triggers the creation/update/deletion of party reference data and informs
 9 about the results (PartyStatusAdviceV01).

10 **7.3.3.4 MANAGE MAINTENANCE RESULTS**

Reference ID	T2S.BPD.STDA.MPTY.03
--------------	----------------------

11 T2S Actors: CSD

12 The CSD receives messages from T2S, which might trigger other internal activities.

13 **7.3.3.4.1 Receive Status Advice**

Reference ID	T2S.BPD.STDA.MPTY.03.01
--------------	-------------------------

14 The CSD receives the status advices informing about the processing results of the CSD Participant
 15 maintenance instruction.

16 If T2S has been instructed via the T2S GUI the status is shown on the screen.

17 This may trigger other internal activities such as updates in the CSD system, notification to the CSD
 18 Participant.

19 In addition, the party administrator of the CSD could grant the relevant privileges to the party administrator
 20 of the CSD Participant (see BPD on Maintenance of Roles and Privileges).

21 The CSD receives the following message from T2S:

1 **Table 7-17: Messages from T2S [T2S.BPD.STDA.MPTY.03.01]**

Message Name	ISO Code	To/From T2S	Event	UDFS Chapter
PartyStatusAdvice V01	reda.016.001.01	From T2S	CSD Participant maintenance request is “queued”, “rejected” or “completed”	3.3.6.10

2

1 **7.4 MAINTENANCE OF PAYMENT BANK [T2S.BPD.STDA.MPBK]**

2 **7.4.1 OVERVIEW**

3 This process describes the act of creating, updating and deleting Payment Bank Reference Data in T2S.

4 The Payment Bank Reference Data in T2S is required for settlement and auto-collateralisation in central
5 bank money. The data can be retrieved via the T2S GUI (U2A) or via A2A queries and reports. T2S allows
6 Central Banks to store additional market-specific attributes for each Payment Bank. The market-specific
7 attributes can be included in reports for informational purpose or used for set-up of processing rules.

8 Each Payment Bank is attributed legally and technically to only one Central Bank.

9 The Payment Bank maintenance process includes all technical activities to maintain the static data
10 information of a Payment Bank.

11 **Trigger:**

12 Central Bank receives a request for maintaining a Payment Bank details in T2S.

13 **Preconditions:**

14 None

15 **T2S Instructing Party:**

16 Central Bank

17 **7.4.2 BUSINESS PROCESS DIAGRAM**

18 **Figure 7-4: Business Process Diagram [T2S.BPD.STDA.MPBK]**

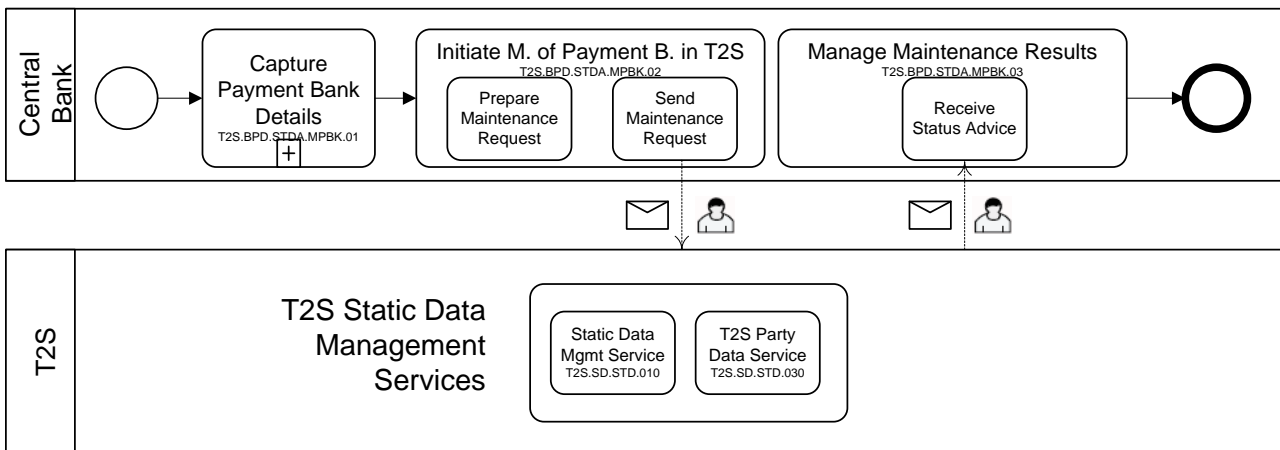

19

1 **7.4.3 BUSINESS PROCESS DESCRIPTION**

2 **7.4.3.1 CAPTURE PAYMENT BANK DETAILS**

Reference ID	T2S.BPD.STDA.MPBK.01
--------------	----------------------

3 T2S Actors: Central Bank

4 The Central Bank collects the Payment Bank data that T2S requires for creating or updating a Payment Bank
5 in T2S upon request of the Payment Bank.

6 **7.4.3.2 INITIATE MAINTENANCE OF PAYMENT BANK IN T2S**

Reference ID	T2S.BPD.STDA.MPBK.02
--------------	----------------------

7 T2S Actors: Central Bank

8 The Central Bank uses the Payment Bank details from the data gathered in the Capture Payment Bank
9 Details process to create a maintenance instruction (i.e. Payment Bank Creation Request, Payment Bank
10 Maintenance Request or Payment Bank Deletion Request) for T2S and sends the instruction to T2S.

11 References:

12 UDFS: Use Case “Maintain SD” (Chapter 2.20)

13 GUI BFD: T2S.GULSDSE.PTY.0010, T2S.GULSDSE.PTY.0020, T2S.GULSDSE.PTY.0030,
14 T2S.GULSDSE.PTY.0040, T2S.GULSDSE.PTY.0050, T2S.GULSDSE.PTY.0060

15 **7.4.3.2.1 Prepare Maintenance Request**

Reference ID	T2S.BPD.STDA.MPBK.02.01
--------------	-------------------------

16 The Central Bank prepares the Payment Bank maintenance instruction.

17 The Payment Bank data¹¹² includes:

- 18 • Payment Bank details with its related validity start (short and long name, party code, address, technical
19 address, opening/closing dates, “Payment Bank” as party type),
- 20 • Market-specific attributes if applicable,
- 21 • Restriction details, if the Payment Bank is blocked and its validity period.

22 *Creation of Payment Bank reference data*

¹¹² Further information about the description of the attributes for Party reference data may be found in the T2S User Requirements Document (requirement T2S.16.550)

1 Payment Bank can be created as of the current or a future business day (i.e. the opening date can be current
2 business date).

3 If a Central Bank defined mandatory market specific attributes, then they must be included in the request for
4 set-up of new Payment Bank in T2S. The Central Bank could include optional market specific attributes as
5 well in any case.

6 *Amendment of Payment Bank reference data*

7 The Central Bank, to which the Payment Bank belongs, can update the Payment Bank’s reference data.

8 Modification of Payment Bank’s reference data will not trigger a real-time validation of pending settlement
9 instructions.

10 If a blocked restriction applying on a Payment Bank is removed by the Central Bank intraday (or the validity
11 is ended), T2S will recycle the transactions previously considered ineligible because of the blocking. If a
12 new blocked restriction is created, T2S will make the relevant transactions ineligible when the blocking
13 becomes active.

14 In order to amend a Payment Bank in U2A, the Central Bank has to query it first.

15 *Deletion of Payment Bank reference data*

16 The Central Bank, to which the Payment Bank belongs, can perform a (logical) deletion of the Payment
17 Bank.

18 A (logical) deletion of the Payment Bank is only allowed if the Payment Bank is closed and there is no link
19 with a Securities Account, T2S Dedicated Cash Account and External RTGS Account.

20 The Central Bank can restore a deleted Payment Bank.

21 In order to delete a Payment Bank in U2A, the Central Bank has to query it first.

22 **7.4.3.2.2 Send Request to T2S**

Reference ID	T2S.BPD.STDA.MPBK.01.02
--------------	-------------------------

23 The Central Bank formats the maintenance instruction depending upon the type of maintenance action (i.e.
24 create, update or delete) with T2S specific Payment Bank reference data and sends the maintenance
25 instruction to T2S.

26 The instruction of T2S is also possible via the T2S GUI.

27 The Central Bank sends the following message to T2S:

28

1 *For creation of reference data*

2 **Table 7-18: Messages to T2S [T2S.BPD.STDA.MPBK.01.02/Creation]**

Message Name	ISO Code	To/From T2S	UDFS Chapter
PartyCreationRequestV01	reda.014.001.01	To T2S	3.3.6.8

3 *For amendment of Payment Bank reference data*

4 **Table 7-19: Messages to T2S [T2S.BPD.STDA.MPBK.01.02/Amendment]**

Message Name	ISO Code	To/From T2S	UDFS Chapter
PartyModificationRequestV01	reda.022.001.01	To T2S	3.3.6.16

5 *For deletion of Payment Bank reference data*

6 **Table 7-20: Messages to T2S [T2S.BPD.STDA.MPBK.01.02/Deletion]**

Message Name	ISO Code	To/From T2S	UDFS Chapter
PartyDeletionRequestV01	reda.031.001.01	To T2S	3.3.6.25

7 **7.4.3.3 T2S PROCESSING**

8 The **Static Data Management Service (T2S.SD.STD.010)** validates the incoming request
 9 (PartyCreationRequestV01 or PartyModificationRequestV01 or PartyDeletionRequestV01). The **T2S Party**
 10 **Data Service (T2S.SD.STD.030)** triggers the creation/update/deletion of party reference data and informs
 11 about the results (PartyStatusAdviceV01).

12 **7.4.3.4 MANAGE MAINTENANCE RESULTS OF PAYMENT BANK**

Reference ID	T2S.BPD.STDA.MPBK.03
--------------	----------------------

13 T2S Actors: Central Bank

14 The Central Bank receives the status advice from T2S, which might trigger other internal activities.

15 **7.4.3.4.1 Receive Status Advice**

Reference ID	T2S.BPD.STDA.MPBK.03.01
--------------	-------------------------

16 The Central Bank receives the status advices informing about the processing results of the Payment Bank
 17 maintenance instruction.

18 If T2S has been instructed via the T2S GUI the status is shown on the screen.

1 This may trigger other internal activities such as updates in the Central Bank system, notification to the
 2 Payment Bank.

3 In addition, the Central Bank may continue defining the auto-collateralisation parameters and close links for
 4 the Payment Bank in U2A or A2A. For details on the set-up of auto-collateralisation rules, refer to process
 5 “Maintenance of Auto-Collateralisation Eligibility [T2S.BPD.STDA.MACE]”. Moreover, the party
 6 administrator of the Central Bank could also grant the relevant privileges to the party administrator of the
 7 Payment Bank.

8 The Central Bank receives the following message from T2S:

9 **Table 7-21: Messages from T2S [T2S.BPD.STDA.MPBK.03.01]**

Message Name	ISO Code	To/From T2S	Event	UDFS Chapter
PartyStatusAdvice V01	reda.016.001.01	From T2S	Payment Bank maintenance request is “queued”, “rejected” or “completed”	3.3.6.10

10

1 **7.5 MAINTENANCE OF DEDICATED CASH ACCOUNT**
2 **[T2S.BPD.STDA.MDCA]**

3 **7.5.1 OVERVIEW**

4 This process describes the act of creating, updating and deleting T2S Dedicated Cash Account Reference
5 Data in T2S.

6 The Dedicated Cash Account Reference Data in T2S is required for the liquidity provision for securities
7 settlement services in T2S. The data can be retrieved via the T2S GUI (U2A) or via A2A queries and reports.

8 Each T2S Dedicated Cash Account is attributed legally and technically to only one Central Bank. The T2S
9 Dedicated Cash Account concept covers all types of Dedicated Cash Accounts (i.e. T2S Central Bank
10 Account, T2S Dedicated Cash Account and RTGS Dedicated Transit Account)¹¹³.

11 The Dedicated Cash Account maintenance process includes all technical activities to maintain the static data
12 information of a Dedicated Cash Account, (i.e. creation, update, and deletion of Dedicated Cash Account
13 reference data).

14 **Trigger:**

15 Central Bank receives a request for maintaining a Dedicated Cash Account.

16 **Preconditions:**

17 None

18 **T2S Instructing Party:**

19 Central Bank

¹¹³ T2S dedicated cash accounts are denominated in a specific T2S settlement currency and they are used for the settlement of the cash leg of Settlement Instructions in T2S;

RTGS Dedicated Transit Accounts are opened by and belong to Central Banks and they are used to track liquidity transfers from/to RTGS;

T2S Central Bank Accounts also belong to central banks and are used to provide intraday liquidity to their payment banks.

1 **7.5.2 BUSINESS PROCESS DIAGRAM**

2 **Figure 7-5: Business Process Diagram [T2S.BPD.STDA.MDCA]**

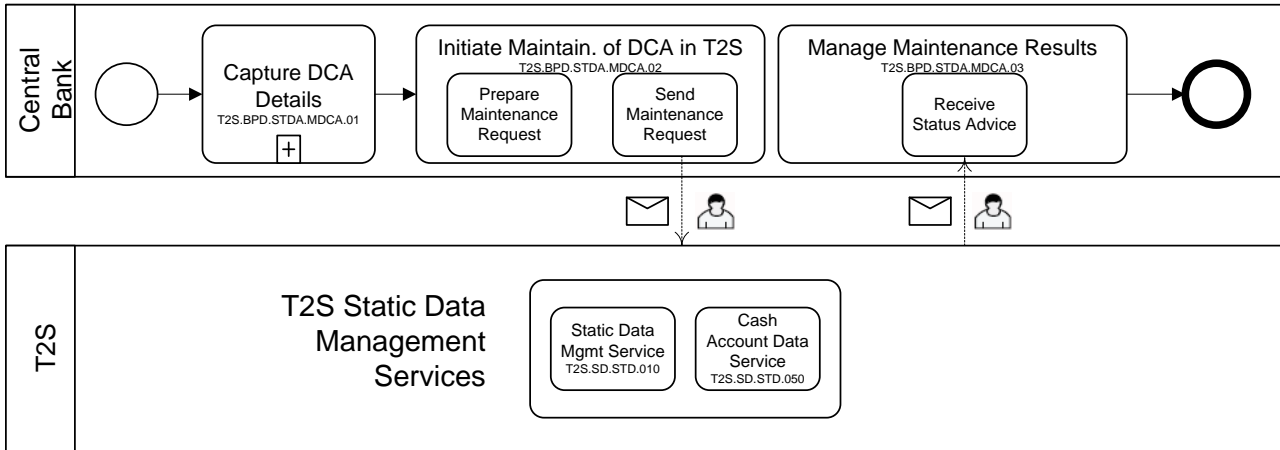

3

4 **7.5.3 BUSINESS PROCESS DESCRIPTION**

5 **7.5.3.1 CAPTURE DEDICATED CASH ACCOUNT DETAILS**

Reference ID	T2S.BPD.STDA.MDCA.01
--------------	----------------------

6 T2S Actors: Central Bank

7 The Central Bank collects the Dedicated Cash Account data that T2S requires for creating or updating a
 8 Dedicated Cash Account in T2S upon request of the Payment Bank. The Dedicated Cash Account data¹¹⁴
 9 includes:

- 10 • T2S Dedicated Cash Account details (T2S Dedicated Cash Account number, account type, currency;
 11 opening/closing date; floor/ceiling notification amounts),
 12 • Payment Bank that owns the T2S dedicated Cash Account,
 13 • External RTGS Account to which the account is linked for end-of-day cash sweep purposes,
 14 • T2S Dedicated Cash Account Restriction if the account is blocked or subject to rejection at validation of
 15 related settlement instructions (under insolvency procedure) and its validity period.

16

¹¹⁴ Further information about the description of the attributes for a Dedicated Cash Account reference data may be found in the T2S User Requirements Document (requirement T2S.16.600)

1 **7.5.3.2 INITIATE MAINTENANCE OF DEDICATED CASH ACCOUNT IN T2S**

Reference ID	T2S.BPD.STDA.MDCA.02
--------------	----------------------

2 T2S Actors: Central Bank

3 The Central Bank uses the Dedicated Cash Account details from the data received in the Capture Dedicated
 4 Cash Account Details step to create a maintenance instruction (i.e. Dedicated Cash Account Maintenance
 5 Request) for T2S and sends the instruction to T2S.

6 This process also allows the Central Bank to authorise a third T2S Party or group of T2S Parties to use a
 7 Dedicated Cash Account.

8 A pre-requisite for this process is the definition of party BIC(s) eligible to use the T2S Dedicated Cash
 9 Account for cash settlement purposes. The Central Bank owning the T2S Dedicated Cash Account is
 10 responsible for the maintaining the list of party BIC(s) in T2S static data.

11 References:

12 UDFS: Use Case “Maintain SD” (Chapter 2.20)

13 GUI BFD: T2S.GUI.SDSE.DCA.0010, T2S.GUI.SDSE.DCA.0020, T2S.GUI.SDSE.DCA.0030,
 14 T2S.GUI.SDSE.DCA.0040, T2S.GUI.SDSE.DCA.0050, T2S.GUI.SDSE.DCA.0060

15 **7.5.3.2.1 Prepare Maintenance Request**

Reference ID	T2S.BPD.STDA.MDCA.02.01
--------------	-------------------------

16 The Central Bank collects the Dedicated Cash Account maintenance details and prepares the Dedicated Cash
 17 Account maintenance instruction.

18 *For creation of Dedicated Cash Account reference data*

19 Dedicated Cash Account can be created as of the current or a future business date (i.e. the opening date can
 20 be current business date).

21 *For amendment of Dedicated Cash Account reference data*

22 The Central Bank, to which the Dedicated Cash Account belongs, can update the Dedicated Cash Account’s
 23 reference data.

24 Modification of the closing date of a Dedicated Cash Account might trigger a revalidation of pending
 25 settlement instructions that included this account.

26 If a blocked restriction applying on a Dedicated Cash Account is removed by the Central Bank intraday (or
 27 the validity is ended), T2S will recycle the transactions previously considered ineligible because of the

1 blocking. If a new blocked restriction is created, T2S will make the relevant transactions ineligible when the
2 blocking becomes active.

3 If a rejection restriction is applied on a Dedicated Cash Account, any settlement instruction debiting the
4 insolvent account will be rejected. Instructions already in the system would not be automatically cancelled.

5 In order to amend a Dedicated Cash Account in U2A, the Central Bank has to query it first.

6

1 *For deletion of Dedicated Cash Account reference data*
 2 The Central Bank, to which the Dedicated Cash Account belongs, can perform a (logical) deletion of the
 3 Dedicated Cash Account.
 4 A (logical) deletion of the Dedicated Cash Account is only allowed as of a future business date. In addition
 5 the Dedicated Cash Account must not to have any link with a Payment Bank/Central Bank, must not be
 6 linked to any liquidity transfer order and must be closed or have an opening date greater than the current
 7 date.
 8 The Central Bank can restore a deleted Dedicated Cash Account.
 9 In order to delete a Dedicated Cash Account in U2A, the Central Bank has to query it first.

10 **7.5.3.2.2 Send Request to T2S**

Reference ID	T2S.BPD.STDA.MDCA.01.02
--------------	-------------------------

11 The Central Bank formats the maintenance instruction depending upon the type of maintenance action (i.e.
 12 create, update or delete) with T2S specific Dedicated Cash Account reference data and sends the
 13 maintenance instruction to T2S.
 14 The instruction of T2S is also possible via the T2S GUI.
 15 The Central Bank sends the following message to T2S:

16 *For creation of Dedicated Cash Account reference data*

17 **Table 7-22: Messages to T2S [T2S.BPD.STDA.MDCA.01.02/Creation]**

Message Name	ISO Code	To/From T2S	UDFS Chapter
AccountOpeningRequest V01	acmt.007.001.01	To T2S	3.3.1.1

18 *For amendment of Dedicated Cash Account reference data*

19 **Table 7-23: Messages to T2S [T2S.BPD.STDA.MDCA.01.02/Amendment]**

Message Name	ISO Code	To/From T2S	UDFS Chapter
AccountExcludedManda teMaintenanceRequestV 01	acmt.015.001.01	To T2S	3.3.1.4

20

1 *For deletion of Dedicated Cash Account reference data*

2 **Table 7-24: Messages to T2S [T2S.BPD.STDA.MDCA.01.02/Deletion]**

Message Name	ISO Code	To/From T2S	UDFS Chapter
AccountClosingRequestV01	acmt.019.001.01	To T2S	3.3.1.5

3 **7.5.3.3 T2S PROCESSING**

4 The **Static Data Management Service (T2S.SD.STD.010)** validates the incoming request
 5 (AccountOpeningRequestV01 or AccountExcludedMandateMaintenanceRequestV01 or
 6 AccountClosingRequestV01). The **Cash Account Data Service (T2S.SD.STD.050)** triggers the
 7 creation/update/deletion of cash account data and informs about the results
 8 (AccountRequestAcknowledgementV01 or AccountRequestRejectionV01).

9 **7.5.3.4 MANAGE MAINTENANCE RESULTS**

Reference ID	T2S.BPD.STDA.MDCA.03
--------------	----------------------

10 T2S Actors: Central Bank

11 The Central Bank receives the status advice from T2S, which might trigger other internal activities.

12 **7.5.3.4.1 Receive Status Advice**

Reference ID	T2S.BPD.STDA.MDCA.03.01
--------------	-------------------------

13 The Central Bank receives the status advices informing about the processing results of the Dedicated Cash
 14 Account maintenance instruction.

15 If T2S has been instructed via the T2S GUI the status is shown on the screen.

16 This may trigger other internal activities such as updates in the Central Bank system, amendment of the
 17 Dedicated Cash Account maintenance instruction, and notification to the Payment Bank.

18 In addition, the Central Bank and Payment Bank may continue defining the auto-collateralisation related
 19 configuration (i.e. limit management, eligible counterparties, securities account for auto-collateralisation).

20 For details on the set-up of auto-collateralisation rules, refer to process “Maintenance of Auto-
 21 Collateralisation Eligibility [T2S.BPD.STDA.MACE]”. For details on limit management, refer to process
 22 “Management of Limits [T2S.BPD.STDA.MLIM]”.

23

1 The Central Bank receives the following messages from T2S:

2 **Table 7-25: Messages from T2S [T2S.BPD.STDA.MDCA.03.01]**

Message Name	ISO Code	To/From T2S	Event	UDFS Chapter
AccountRequestAc knowledgeV0 1	acmt.010.001.01	From T2S	T2S Dedicated Cash Account maintenance request is “queued” or “completed”	3.3.1.2
AccountRequestRe jectionV01	acmt.011.001.01	From T2S	“rejection” of a T2S Dedicated Cash Account maintenance request	3.3.1.3

3

1 7.6 MAINTENANCE OF EXTERNAL RTGS ACCOUNT [T2S.BPD.STDA.MRAC]

2 7.6.1 OVERVIEW

3 This process describes the act of creating, updating and deleting External RTGS Account Reference Data
4 using the T2S Graphical User Interface (GUI) – U2A communication mode.

5 The External RTGS Account Reference Data in T2S is required for

- 6 • The definition of T2S dedicated cash accounts,
- 7 • transferring liquidity from T2S dedicated cash account to an RTGS account via an outbound liquidity
8 transfer,
- 9 • the validation of internal liquidity transfers connected to the same RTGS account,
- 10 • and the retransfer of liquidity from the T2S dedicated cash accounts to the RTGS systems at the end of
11 the day.

12 The data can be retrieved via the T2S GUI.

13 The External RTGS Account Reference Data business object is referenced by the Liquidity transfer service
14 in business processes of liquidity management. Each External RTGS Account is attributed legally and
15 technically to only one Central Bank.

16 The External RTGS Account maintenance process includes all technical activities to maintain the static data
17 information of an External RTGS Account, (i.e. creation, update, and deletion of External RTGS Account
18 reference data).

19 **Trigger:**

- 20 • The Central Bank receives a request to create a T2S Dedicated Cash Account that is linked to a central
21 bank money account opened in the books of a Central Bank in a RTGS outside T2S and the latter
22 account has not already been created by the Central Bank in T2S.
- 23 • The Central Bank wants either to delete or edit the details of an External RTGS Account (e.g. to add or
24 update a restriction on the Account).

25 **Preconditions:**

26 None

27 **T2S Instructing Party:**

28 Central Bank

1 **7.6.2 BUSINESS PROCESS DIAGRAM**

2 **Figure 7-6: Business Process Diagram [T2S.BPD.STDA.MRAC]**

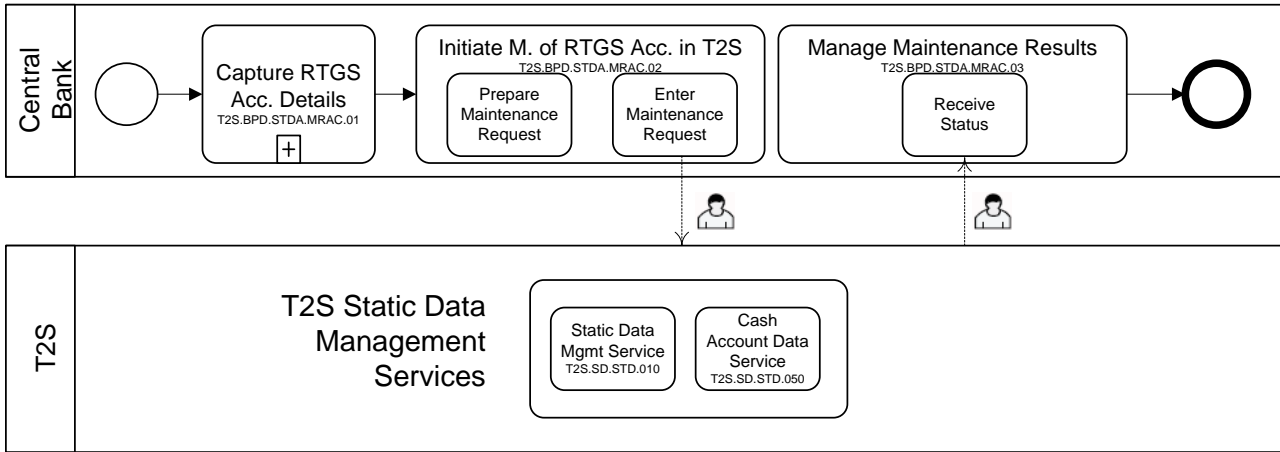

3

4 **7.6.3 BUSINESS PROCESS DESCRIPTION**

5 **7.6.3.1 CAPTURE EXTERNAL RTGS ACCOUNT DETAILS**

Reference ID	T2S.BPD.STDA.MRAC.01
--------------	----------------------

6 T2S Actors: Central Bank

7 The Central Bank collects the External RTGS Account data that T2S requires for creating or updating an
8 External RTGS Account in T2S. The External RTGS Account data¹¹⁵ includes:

- 9
- 10 • External RTGS account details (RTGS system outside T2S to which the account belongs; account reference in the RTGS system outside T2S; currency),
 - 11 • External RTGS Account Restriction if the RTGS account is (to be) blocked and its validity period.

12 **7.6.3.2 INITIATE MAINTENANCE OF EXTERNAL RTGS ACCOUNT IN T2S**

Reference ID	T2S.BPD.STDA.MRAC.02
--------------	----------------------

13 T2S Actors: Central Bank

14 The Central Bank uses the External RTGS Account details from the data received in the Capture External
15 RTGS Account Details step to enter the data and submit the request in the T2S GUI (U2A).

16

¹¹⁵ Further information about the description of the attributes for a Dedicated Cash Account reference data may be found in the T2S User Requirements Document (requirement T2S.16.655)

1 References:

2 GUI BFD: T2S.GUI.SDSE.RGA.0010. T2S.GUI.SDSE.RGA.0020, T2S.GUI.SDSE.RGA.0030,
 3 T2S.GUI.SDSE.RGA.0040, T2S.GUI.SDSE.RGA.0050, T2S.GUI.SDSE.RGA.0060

4 **7.6.3.2.1 Prepare Maintenance Request**

Reference ID	T2S.BPD.STDA.MRAC.02.01
--------------	-------------------------

5 The Central Bank enriches the External RTGS Account maintenance request.

6 *For creation of external RTGS account reference data*

7 External RTGS Account is created as of the current business date.

8 *For amendment of external RTGS account reference data*

9 The Central Bank, to which the External RTGS Account belongs, can update the External RTGS Account's
 10 reference data intraday.

11 Modification of External RTGS Account's reference data will not trigger a real-time validation of pending
 12 settlement instructions.

13 If a blocked restriction applying on a External RTGS Account is removed by the Central Bank intraday (or
 14 the validity is ended), T2S will recycle the transactions previously considered ineligible because of the
 15 blocking. If a new blocked restriction is created, T2S will make the relevant transactions ineligible when the
 16 blocking becomes active.

17 In order to amend an External RTGS Account, the Central Bank has to query it first.

18 *For deletion of external RTGS account reference data*

19 The Central Bank, to which the External RTGS Account belongs, can perform a (logical) deletion of the
 20 External RTGS Account.

21 A (logical) deletion of the External RTGS Account is only allowed as of the current business date. T2S does
 22 not allow the deletion if there is an active link with at T2S Dedicated Cash Account, and it is defined in a
 23 current standing liquidity transfer order.

24 The Central Bank can restore a deleted External RTGS Account.

25 In order to delete an External RTGS Account, the Central Bank has to query it first.

26

1 **7.6.3.2.2 Enter Maintenance Request**

Reference ID	T2S.BPD.STDA.MRAC.01.02
--------------	-------------------------

2 The Central Bank captures the maintenance instruction request in T2S via the T2S GUI.

3 **7.6.3.3 T2S PROCESSING**

4 The **Static Data Management Service (T2S.SD.STD.010)** validates the incoming request entered via the
 5 GUI and shows the acceptance or rejection of the request on the screen. The **Cash Account Data Service**
 6 **(T2S.SD.STD.050)** triggers the creation/update/deletion of RTGS account data.

7 **7.6.3.4 MANAGE MAINTENANCE RESULTS**

Reference ID	T2S.BPD.STDA.MRAC.03
--------------	----------------------

8 T2S Actors: Central Bank

9 The Central Bank can view the results of validation/processing of the request in the T2S GUI.

10 **7.6.3.4.1 Receive Status**

Reference ID	T2S.BPD.STDA.MRAC.03.01
--------------	-------------------------

11 The Central Bank views the results of validation/processing of the request in the T2S GUI. The Central Bank
 12 might trigger other internal activities such as updates in the Central Bank system, and the creation or
 13 maintenance of the relevant T2S Dedicated Cash Accounts.

14

1 **7.7 MAINTENANCE OF MESSAGE SUBSCRIPTION [T2S.BPD.STDA.MMSG]**

2 **7.7.1 OVERVIEW**

3 This process describes the act of creating, updating and deleting message subscriptions in T2S.

4 CSDs, Central banks and their directly connected parties may need a variety of information from T2S in the
5 form of messages, reports and queries to conduct its daily business activities. Such needs can be for its asset
6 and custodial services, cash settlement services, securities settlement services, corporate actions, securities
7 lending and borrowing, money market settlement etc.

8 T2S in its current scope provides a facility to choose the messages that the CSDs, Central Banks and their
9 participants wish to receive from T2S via message subscriptions. T2S will not send any message not
10 subscribed beforehand. The exception is for the messages; A2A acknowledgement on receipt, Reactions on
11 erroneous inbound messages, Query results, which does not require any message subscription. All changes in
12 message subscription need to be conducted using the T2S GUI. Only CSDs and Central Banks can configure
13 the message subscription on their own behalf or on behalf of their participants. The maintenance of the
14 message subscription rules and rule set is only possible as of a future date.

15 **Trigger:**

16 The CSD/ Central Bank identifies the need to create, update or remove message subscriptions.

17 **Preconditions:**

18 None

19 **T2S Instructing Party:**

20 There are two scenarios for the instruction of T2S:

- 21 • Scenario A: CSD instructs T2S (on its own behalf or on behalf of its participants).
22 • Scenario B: Central Bank instructs T2S (on its own behalf or on behalf of its participants).

1 **7.7.2 BUSINESS PROCESS DIAGRAM**

2 **Figure 7-7: Business Process Diagram [T2S.BPD.SETT.MMSG]**

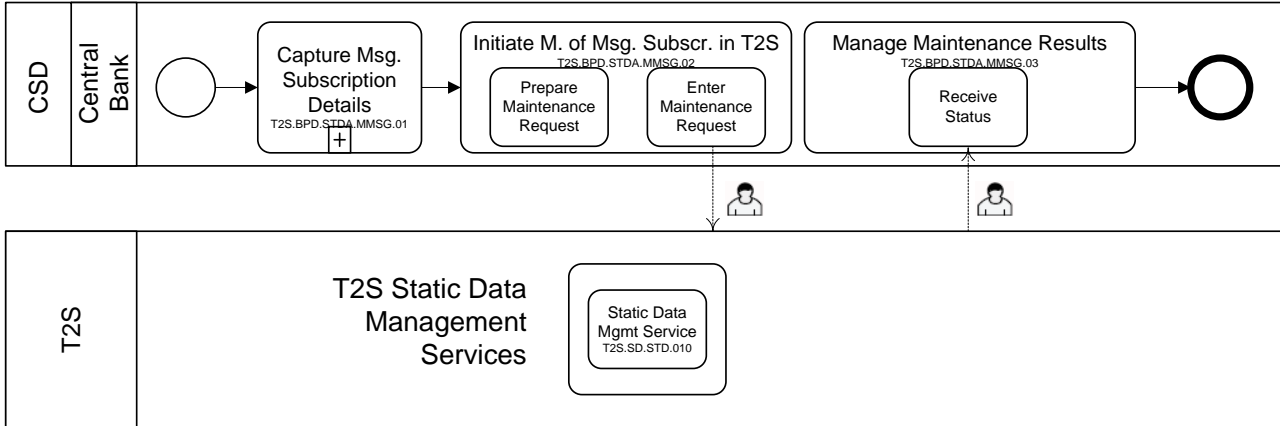

3

4 **7.7.3 BUSINESS PROCESS DESCRIPTION**

5 This Business Process Description is applicable to Scenario A and B unless otherwise noted. For the purpose
 6 of readability, the actor names in the text refer to Scenario A with the Scenario B actor indicated in square
 7 brackets.

8 **7.7.3.1 CAPTURE MESSAGE SUBSCRIPTION DETAILS**

Reference ID	T2S.BPD.SETT.MMSG.01
--------------	----------------------

9 T2S Actors: CSD (Scen.A) / Central Bank (Scen.B)

10 The CSD [Central Bank] verifies incoming maintenance requests from its clients and captures them.

11 **7.7.3.1.1 Initiate Maintenance of Message Subscription in T2S**

Reference ID	T2S.BPD.SETT.MMSG.02
--------------	----------------------

12 T2S Actors: CSD (Scen.A) / Central Bank (Scen.B)

13 The CSD [Central Bank] initiates the creation/update/removal of message subscriptions via the T2S GUI. It
 14 is not possible to send messages for the maintenance of message subscriptions.

15 References:

16 T2S GUI: T2S.GUI.INSE.MSB.0010, T2S.GUI.INSE.MSB.0020, T2S.GUI.INSE.MSB.0030,
 17 T2S.GUI.INSE.MSB.0040, T2S.GUI.INSE.MSB.0050, T2S.GUI.INSE.MSB.0060

18 **7.7.3.1.1.1 Prepare Maintenance Request**

Reference ID	T2S.BPD.SETT.MMSG.02.01
--------------	-------------------------

1 The CSD [Central Bank] collects all information necessary to create/update/remove a message subscription.

2 **7.7.3.1.1.2 Enter Maintenance Request**

Reference ID	T2S.BPD.SETT.MMSG.02.02
--------------	-------------------------

3 The CSD [Central Bank] enters the data required by T2S into the T2S GUI.

4 The CSD [Central Bank] can specify its message subscription needs for push mode information by setting
 5 values for different criteria in T2S and a determined validity period. The CSD [Central Bank] can subscribe
 6 to any message or any copy of any message, according to its access rights (including "power of attorney"). In
 7 this case, copy refers to a message sent to a party (who is neither the instructing party, nor the counterparty
 8 to the instruction) communicating the exact same information as that sent to the instructing
 9 party/counterparty to the instruction. T2S allows CSD [Central Bank] and its directly connected parties to
 10 include or exclude one or several message subscription criteria but still subscribe to all the messages for the
 11 remaining criteria.

12 **7.7.3.1.2 T2S Processing**

13 The **Static Data Management Service (T2S.SD.STD.010)** validates the incoming request entered via the
 14 GUI and shows the acceptance or rejection of the request on the screen. It also triggers the
 15 creation/maintenance/deletion of the message subscription.

16 **7.7.3.1.3 Manage Maintenance Results**

Reference ID	T2S.BPD.SETT.MMSG.03
--------------	----------------------

17 T2S Actors: CSD (Scen.A) / Central Bank (Scen.B)

18 The CSD [Central Bank] views the on-screen message about the approval or rejection of the maintenance
 19 request to initiate any further processing.

20 References:

21 T2S GUI: T2S.GUI.INSE.MSB.0010, T2S.GUI.INSE.MSB.0020, T2S.GUI.INSE.MSB.0030,
 22 T2S.GUI.INSE.MSB.0040, T2S.GUI.INSE.MSB.0050, T2S.GUI.INSE.MSB.0060

23

1 **7.8 MAINTENANCE OF REPORT SUBSCRIPTION [T2S.BPD.STDA.MREP]**

2 **7.8.1 OVERVIEW**

3 This process describes the act of creating, updating and deleting report subscriptions in T2S.
 4 T2S Actors such as CSDs, Central Banks and their directly connected parties may need a variety of
 5 information from T2S in the form of messages, reports and queries to conduct its daily business activities.
 6 Such needs can be for its asset and custodial services, cash settlement services, securities settlement services,
 7 corporate actions, securities lending and borrowing, money market settlement etc.
 8 T2S in its current scope provides a facility to choose the reports they do or do not wish to receive from T2S.
 9 T2S will not send any report not subscribed beforehand by the CSD, Central Bank or directly connected T2S
 10 party concerned. All changes in report subscription need to be conducted using the T2S GUI.

11 **Trigger:**

12 The T2S Actor identifies the need to create, update or remove report subscriptions.

13 **Preconditions:**

14 None

15 **T2S Instructing Party:**

16 There are four scenarios for the instruction of T2S:

- 17 • Scenario A: CSD instructs T2S.
- 18 • Scenario B: CSD Participant instructs T2S.
- 19 • Scenario C: Central Bank instructs T2S.
- 20 • Scenario D: Payment Bank instructs T2S.

21 **7.8.2 BUSINESS PROCESS DIAGRAM**

22 **Figure 7-8: Business Process Diagram [T2S.BPD.SETT.MMSG]**

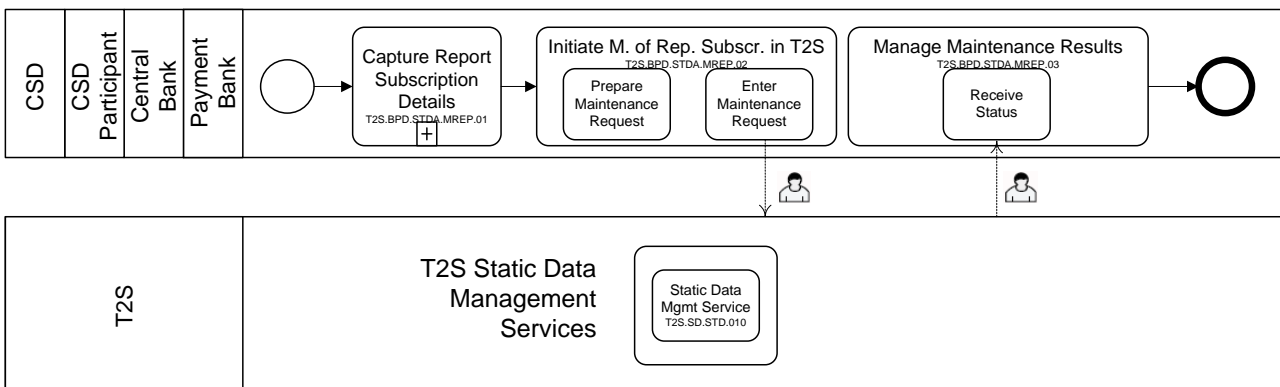

1 **7.8.3 BUSINESS PROCESS DESCRIPTION**

2 This Business Process Description is applicable to all scenarios unless otherwise noted. For the purpose of
 3 readability, the actor names in the text refer to Scenario A with the other scenarios' actors indicated in square
 4 brackets.

5 **7.8.3.1 CAPTURE REPORT SUBSCRIPTION DETAILS**

Reference ID	T2S.BPD.SETT.MREP.01
--------------	----------------------

6 T2S Actors: CSD (Scen.A)/CSD Participant (Scen.B)/Central Bank (Scen.C)/Payment Bank (Scen.D)

7 The CSD [CSD Participant/Central Bank/Payment Bank] verifies incoming maintenance requests.

8 **7.8.3.1.1 Initiate Maintenance of Report Subscription in T2S**

Reference ID	T2S.BPD.SETT.MREP.02
--------------	----------------------

9 T2S Actors: CSD (Scen.A)/CSD Participant (Scen.B)/Central Bank (Scen.C)/Payment Bank (Scen.D)

10 The CSD [CSD Participant/Central Bank/Payment Bank] initiates the creation/update/removal of message
 11 subscriptions via the T2S GUI. It is not possible to send messages for the maintenance of report
 12 subscriptions.

13 References:

14 T2S GUI: T2S.GUI.INSE.RPT.0010, T2S.GUI.INSE.RPT.0020, T2S.GUI.INSE.RPT.0030,
 15 T2S.GUI.INSE.RPT.0040, T2S.GUI.INSE.RPT.0060

16 **7.8.3.1.1.1 Prepare Maintenance Request**

Reference ID	T2S.BPD.SETT.MREP.02.01
--------------	-------------------------

17 The CSD [CSD Participant/Central Bank/Payment Bank] collects all information necessary to
 18 create/update/remove a report subscription.

19 **7.8.3.1.1.2 Enter Maintenance Request**

Reference ID	T2S.BPD.SETT.MREP.02.02
--------------	-------------------------

20 The CSD [CSD Participant/Central Bank/Payment Bank] enters the data required by T2S into the T2S GUI.

21 The CSD [CSD Participant/Central Bank/Payment Bank] can specify the relevant reports needs for a time or
 22 event driven reporting by setting values for different report subscription criteria such as full or delta reports,
 23 push/pull mode, etc. T2S will generate reports based on the report subscriptions, for those who have
 24 subscribed for.

1 Additionally, this service gives the CSDs [CSD Participants/Central Banks/Payment Banks] the possibility to
 2 subscribe to any report with the intended list of recipients. The CSD/NCB can also configure a report for all
 3 its scope, e.g. “system entity wide report” for a given report type.

4 **7.8.3.1.2 T2S Processing**

5 The **Static Data Management Service (T2S.SD.STD.010)** validates the incoming request entered via the
 6 GUI and shows the acceptance or rejection of the request on the screen. It also triggers the
 7 creation/update/deletion of the report subscription.

8 **7.8.3.1.3 Manage Maintenance Results**

Reference ID	T2S.BPD.SETT.MREP.03
--------------	----------------------

9 T2S Actors: CSD (Scen.A)/CSD Participant (Scen.B)/Central Bank (Scen.C)/Payment Bank (Scen.D)

10 The CSD [CSD Participant/Central Bank/Payment Bank] views the on-screen message about the approval or
 11 rejection of the maintenance request.

12 References:

13 T2S GUI: T2S.GUI.INSE.RPT.0010, T2S.GUI.INSE.RPT.0020, T2S.GUI.INSE.RPT.0030,
 14 T2S.GUI.INSE.RPT.0040, T2S.GUI.INSE.RPT.0060

15

1 **7.9 MAINTENANCE OF ROLES [T2S.BPD.STDA.MROL]**

2 **7.9.1 OVERVIEW**

3 This process describes the act of creating, updating and deleting roles in T2S.

4 T2S uses privileges to grant T2S Actors access to T2S functionality. Examples of possible privileges in T2S
 5 are “add security”, “delete security”, “update security” and “display security”, etc. Similarly, examples of
 6 possible roles which can be configured by CSDs, Central Banks other authorized T2S parties are “Securities
 7 management”, “Party management” etc.

8 Roles are used to group individual privileges for easier maintenance. T2S Actors can create/ update/ remove
 9 roles for themselves or on behalf of their clients.

10 The privileges can be maintained by the T2S Operator only.

11 **Trigger:**

12 The T2S Actor identifies the need to create, update or remove roles configured in T2S.

13 **Preconditions:**

14 None

15 **T2S Instructing Party:**

16 There are four scenarios for the instruction of T2S:

- 17 • Scenario A: CSD instructs T2S.
 18 • Scenario B: CSD Participant instructs T2S.
 19 • Scenario C: Central Bank instructs T2S.
 20 • Scenario D: Payment Bank instructs T2S.

21 **7.9.2 BUSINESS PROCESS DIAGRAM**

22 **Figure 7-9: Business Process Diagram [T2S.BPD.SETT.MROL]**

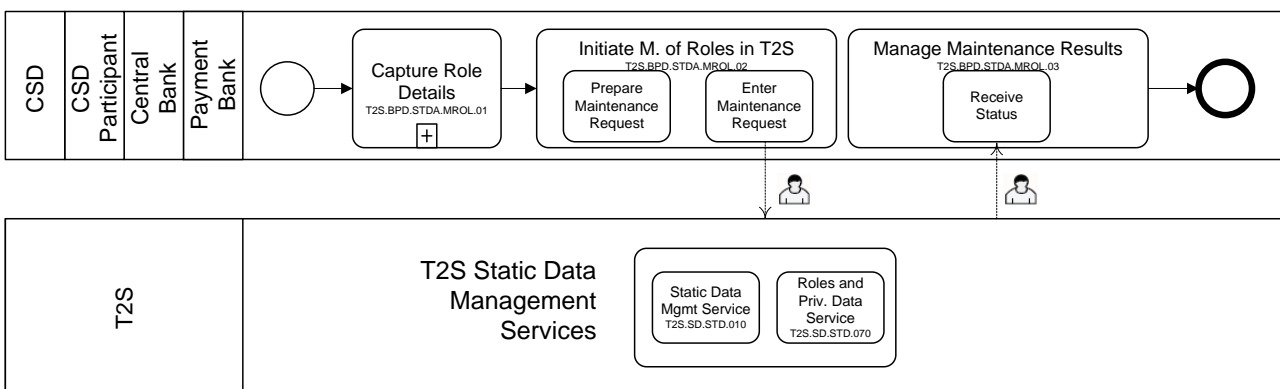

23

1 **7.9.3 BUSINESS PROCESS DESCRIPTION**

2 This Business Process Description is applicable to all scenarios unless otherwise noted. For the purpose of
 3 readability, the actor names in the text refer to Scenario A with the other scenarios' actors indicated in square
 4 brackets.

5 **7.9.3.1 CAPTURE ROLE DETAILS**

Reference ID	T2S.BPD.SETT.MROL.01
--------------	----------------------

6 T2S Actors: CSD, CSD Participant, Central Bank, Payment Bank

7 The CSD [CSD Participant, Central Bank, Payment Bank] queries the list of available roles and privileges as
 8 well as the current configuration of their roles in T2S via the T2S GUI.

9 References:

10 T2S GUI: T2S.GUI.SDSE.PRI.0010, T2S.GUI.SDSE.PRI.0020, T2S.GUI.SDSE.ROL.0010,
 11 T2S.GUI.SDSE.ROL.0020, T2S.GUI.SDSE.ROL.0030, T2S.GUI.SDSE.ROL.0040,
 12 T2S.GUI.SDSE.ROL.0050

13 **7.9.3.2 INITIATE MAINTENANCE IN T2S**

Reference ID	T2S.BPD.SETT.MROL.02
--------------	----------------------

14 T2S Actors: CSD, , Central Bank

15 The CSD [Central Bank] initiates the creation/update/removal of roles.

16 References:

17 T2S GUI: T2S.GUI.SDSE.PRI.0010, T2S.GUI.SDSE.PRI.0020, T2S.GUI.SDSE.ROL.0010,
 18 T2S.GUI.SDSE.ROL.0020, T2S.GUI.SDSE.ROL.0030, T2S.GUI.SDSE.ROL.0040,
 19 T2S.GUI.SDSE.ROL.0050, T2S.GUI.SDSE.ROL.0060

20 **7.9.3.2.1 Prepare Maintenance Request**

Reference ID	T2S.BPD.SETT.MROL.02.01
--------------	-------------------------

21 The CSD [Central Bank] identifies the necessary updates and gathers all information necessary to
 22 create/update/remove the corresponding roles.

23 **7.9.3.3 ENTER MAINTENANCE REQUEST**

Reference ID	T2S.BPD.SETT.MROL.02.02
--------------	-------------------------

1 The CSD [Central Bank] enters the data required by T2S into the T2S GUI.

2 **7.9.3.4 T2S PROCESSING**

3 The **Static Data Management Service (T2S.SD.STD.010)** validates the incoming request entered via the
 4 GUI and shows the acceptance or rejection of the request on the screen. The **Roles and Privileges Data**
 5 **Service (T2S.SD.STD.070)** triggers the creation/update/deletion of roles (with or without its privileges).

6 **7.9.3.5 MANAGE MAINTENANCE RESULTS**

Reference ID	T2S.BPD.SETT.MROL.03
--------------	----------------------

7 T2S Actors: CSD, Central Bank

8 The CSD [CSD Participant, Central Bank, Payment Bank] views the on-screen message about the approval
 9 or rejection of the maintenance request, to perform any further processing.

10 References:

11 T2S GUI: T2S.GUI.SDSE.ROL.0010, T2S.GUI.SDSE.ROL.0020, T2S.GUI.SDSE.ROL.0030,
 12 T2S.GUI.SDSE.ROL.0040, T2S.GUI.SDSE.ROL.0050, T2S.GUI.SDSE.ROL.0060

13 **7.9.3.6 MANAGE MAINTENANCE RESULTS**

Reference ID	T2S.BPD.SETT.MROL.03.01
--------------	-------------------------

14 The CSD [CSD ParticipantPayment Bank] views the status of the processing in the T2S GUI.

15

1 7.10 MAINTENANCE OF RESTRICTIONS [T2S.BPD.STD.MRES]

2 7.10.1 OVERVIEW

3 This process describes the act of creating, updating and deleting restriction in T2S as accessible to CSDs and
4 Central Banks via T2S GUI.

5 The T2S restriction concept covers three aspects:

6 *Case 1: Definition and set-up of restrictions for settlement instructions and settlement restrictions, i.e.*
7 *“rejection” and “CSD Validation Hold”*

8 The CSD can create restrictions so that T2S performs additional validations on the settlement instructions
9 and settlement restrictions on securities sent by itself or its participants (e.g. CSD Participants). These
10 additional validations can result in the “rejection” of the settlement instruction or settlement restriction on
11 securities position, or it can result in the settlement instruction to be set on “CSD Validation Hold”¹¹⁶ by
12 T2S. The validation in T2S is based on a set of rules for which parameter type values have been defined in
13 static data. Market specific attributes for parties, securities and securities account can also be used as
14 parameters for the rules.

15 The Central Bank can similarly define restrictions so that T2S performs additional validations on the
16 settlement restriction on cash balance sent by itself or its participants (e.g. Payment Banks). These additional
17 validations can only result in the “rejection” of the settlement restriction on cash balance based on a set of
18 rules for which some parameter types values have been defined in static data. Market specific attributes for
19 parties can also be used as parameters for the rules.

20 In a cross-CSD settlement scenario, the Issuer CSD will set-up the rules for CSD Validation Hold, which
21 will apply on the realignment instructions. Upon being notified of the CSD Validation Hold the Issuer CSD
22 can release the realignment instructions. However, it is not possible for the Issuer CSD to cancel the original
23 settlement instructions coming from the Investor CSD, nor the realignment instructions generated by T2S.
24 Therefore the Investor CSDs can implement the same restrictions as the Issuer CSD and put the underlying
25 settlement instructions on hold directly. Similarly, in case of settlement within an Investor CSD, where the
26 restrictions set-up by the Issuer CSD do not apply (as there are no realignment messages), the Investor will
27 need to replicate the restrictions.

28

¹¹⁶ “CSD Validation Hold” is not applicable to settlement restriction on securities (also not for settlement restriction on cash balance)

1 *Case 2: Definition and set-up of restrictions for securities account, securities, party, T2S dedicated cash*
2 *account and RTGS account (i.e. intra-day restrictions)*

3 The CSDs can define restrictions for the following objects: securities account, security, party. These
4 restrictions do not require the set-up of matrix of rules with a set of parameter types except for the securities
5 object for which the ISO transaction code can be used. They are applied to the relevant static data object via
6 static data maintenance requests for intra-day restriction e.g. blocking of an ISIN, blocking of a securities
7 account, blocking of a CSD Participant.

8 The Central Banks can define restrictions for the following objects: T2S dedicated cash account, party and
9 RTGS account. These restrictions do not require either the set-up of matrix of rules with a set of parameter
10 types. They are as well applied to the object via static data maintenance requests for intra-day restrictions
11 (e.g. blocking of T2S dedicated cash account, blocking of Payment Bank, blocking of RTGS account).

12 For details on restrictions on static data objects, refer to section “Static Data Restriction Processes”.

13 *Case 3: Definition and set-up of restrictions for securities position and cash balance*

14 The CSD can define restrictions applying on the securities position object. These restrictions are used to
15 segregate the holdings on a given securities account. Different processing type such as “blocking”,
16 “reservation” or “earmarking” can be used. These restrictions do not necessitate the set-up of set of rules.

17 The Central Bank can define restrictions applying on the cash balance object. These restrictions are used to
18 segregate the balance on a given dedicated cash account. Different processing type such as “blocking” and
19 “reservation” can be created. These restrictions do not necessitate the set-up of set of rules.

20 For details on the reservation or blocking of a securities position, refer to process “Reservation or Blocking
21 of Securities Position [T2S.BPD.SETT.RBSP]”.

22 For details on the reservation or blocking of cash balance, refer to process “Reservation or Blocking of Cash
23 Balance [T2S.BPD.SETT.RBCB]”.

24 For details on the earmarking of a securities position, refer to process “Earmarking of Securities Position
25 [T2S.BPD.SETT.EARM]”.

26 *Case 4: Definition and set-up of restriction of securities accounts and T2S dedicated cash accounts for*
27 *insolvency procedures.*

28 *The CSD can define a specific intraday restriction on a securities account being its owner under insolvency*
29 *procedures. This restriction does not require the set-up of matrix of rules with a set of parameter types. It is*
30 *applied to the relevant securities account via static data maintenance request for intra-day restriction i.e.*
31 *rejection of incoming settlement instructions intended to debit a securities account of the insolvent Party.*

32

1 The Central Bank can define a specific intraday restriction on a cash account being its owner under
 2 insolvency procedures. This restriction does not require the set-up of matrix of rules with a set of parameter
 3 types. It is applied to the relevant T2S dedicated cash account via static data maintenance request for intra-
 4 day restriction i.e. rejection of incoming settlement instructions intended to debit a cash account of the
 5 insolvent Party.

6

7 **Trigger:**

8 The CSD or Central Bank identifies the need to create, amend or delete a restriction type, its details, its rules
 9 or parameter values either for additional specific validations, intra-day restrictions or specific sub-
 10 position/balance.

11 **Preconditions:**

12 In case of maintenance or deletion of existing restriction type, the restriction type needs to be known in T2S.

13 **T2S Instructing Party:**

14 There are two scenarios for the instruction of T2S:

- 15 • Scenario A: CSD instructs T2S.
- 16 • Scenario B: Central Bank instructs T2S.

17 **7.10.2 BUSINESS PROCESS DIAGRAM**

18 **Figure 7-10: Business Process Diagram [T2S.BPD.STDA.MRES]**

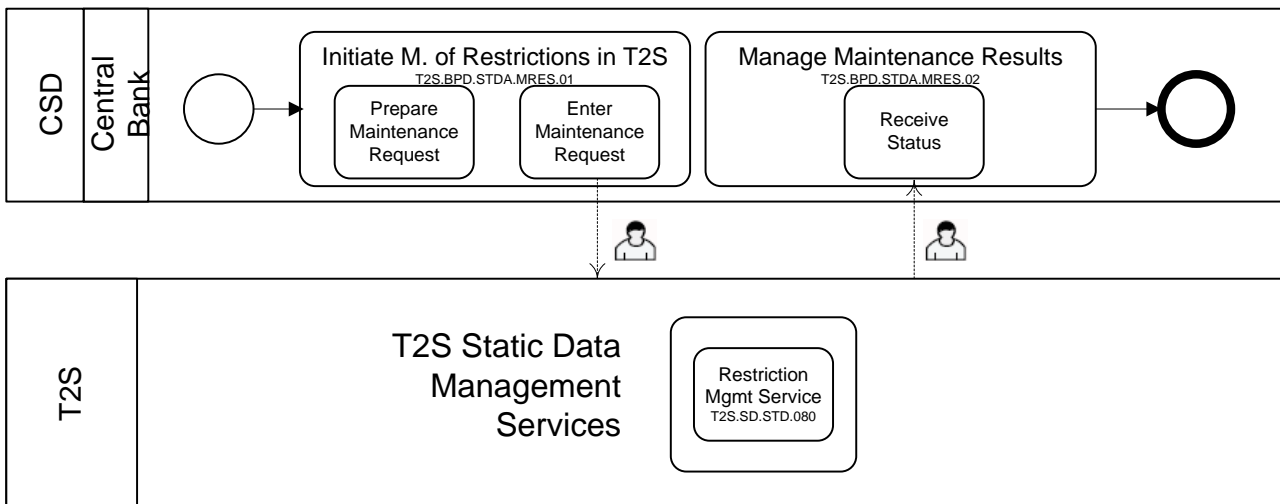

19

1 **7.10.3 BUSINESS PROCESS DESCRIPTION**

2 This Business Process Description is applicable to Scenario A and B unless otherwise noted. For the purpose
 3 of readability, the actor names in the text refer to Scenario A with the Scenario B actor indicated in square
 4 brackets.

5 **7.10.3.1 INITIATE MAINTENANCE OF RESTRICTIONS IN T2S**

Reference ID	T2S.BPD.STD.MRES.01
--------------	---------------------

6 T2S Actors: CSD (Scenario A)/Central Bank (Scenario B)

7 The CSD [Central Bank] enriches the maintenance request with details required for the static data processing
 8 in T2S and sends the static data maintenance instruction to T2S via GUI. No messages are available for the
 9 creation of restriction in T2S.

10 References:

11 GUI BFD: T2S.GUI.SDSE.RST.0010, T2S.GUI.SDSE.RST.0020, T2S.GUI.SDSE.RST.0030,
 12 T2S.GUI.SDSE.RST.0040, T2S.GUI.SDSE.RST.0050, T2S.GUI.SDSE.RST.0060,
 13 T2S.GUI.SDSE.RST.0070, T2S.GUI.SDSE.RST.0080, T2S.GUI.SDSE.RST.0090,
 14 T2S.GUI.SDSE.RST.0100, T2S.GUI.SDSE.RST.0110, T2S.GUI.SDSE.RST.0120,
 15 T2S.GUI.SDSE.RST.0130.

16 **7.10.3.1.1 Prepare Maintenance Request**

Reference ID	T2S.BPD.STD.MRES.01.01
--------------	------------------------

17 The CSD [Central Bank] can create, update or delete restriction types. It may use the queries in T2S to view
 18 existing restriction type details and the rules matrix associated when relevant.

19 The CSD [Central Bank] can enhance the maintenance request with the details (such as T2S party identifiers,
 20 market specific attributes, etc), as needed for T2S.

21 **Table 7-26: Restriction Process Types and Objects Available for Case 1 [T2S.BPD.STD.MRES.01.01]**

Restriction processing	Object	Actor
Rejection	Settlement instruction	CSD
	Restriction on securities position	CSD
	Restriction on cash balance	Central Bank
CSD Validation Hold	Settlement instruction	CSD

- 1 *For creation of restrictions*
- 2 The CSD [Central Bank] creates a restriction by defining a restriction type code and a description, selecting
- 3 the required processing type and relevant object. It also specifies the validity dates of the restriction type as
- 4 well as whether the restriction type created is a positive or negative one, i.e. whether T2S applies the
- 5 restriction based on the parameters that will be defined in the rule(s) (positive) or not (negative).
- 6 In a second step the CSD [Central Bank] creates a rule set that will include the rules and criteria for the
- 7 possible triggering of the restriction type. Within a rule the CSD [Central Bank] can define multiple groups.

8 **Figure 7-11: Rule Sets in T2S [T2S.BPD.STD.MRES.01.01]**

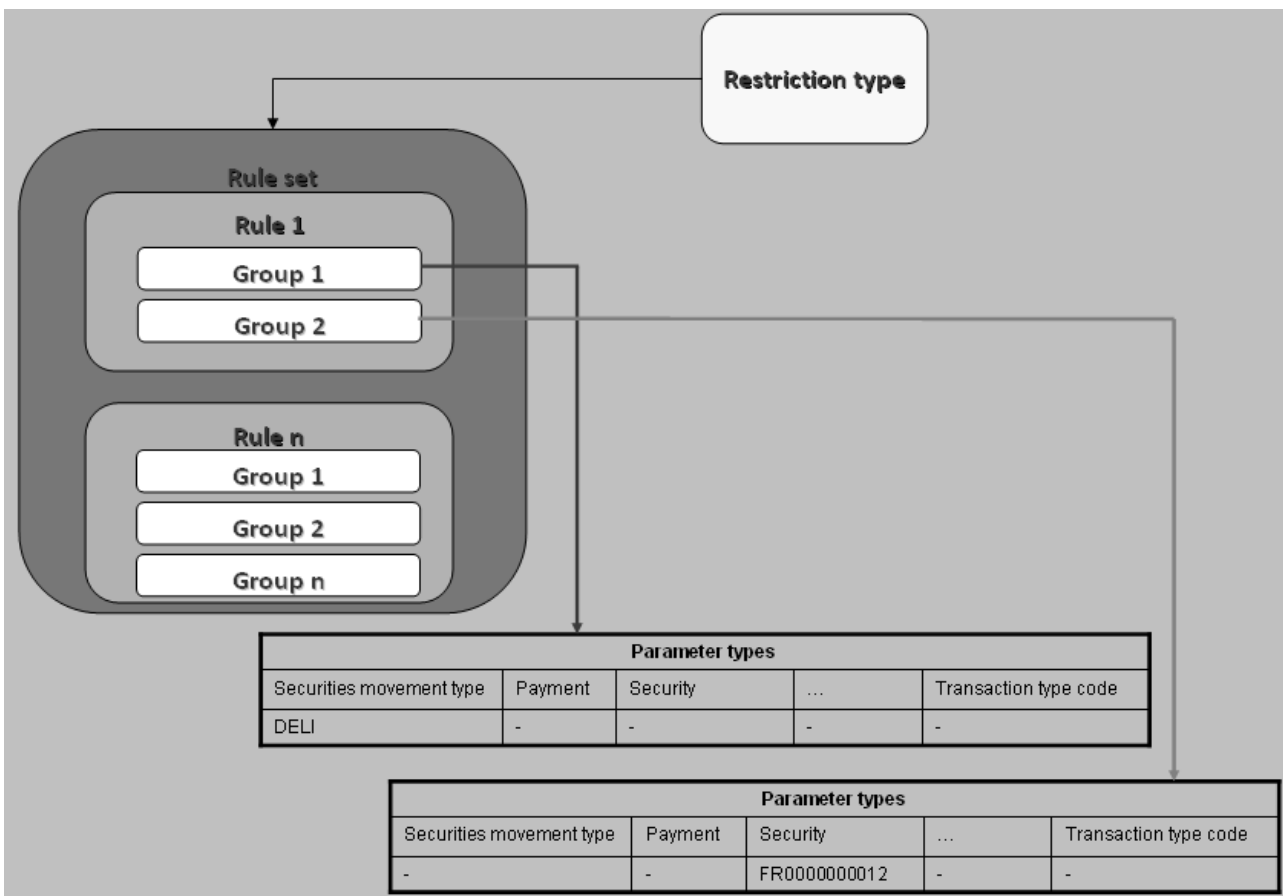

- 9
- 10 If the CSD [Central Bank] creates multiple rules, a rule matrix and the sequence in which the rules will be
- 11 checked is created.

- 12 *For modification of restrictions*
- 13 The CSD [Central Bank] can modify the parameter type's values for the groups; change the validity dates of
- 14 a restriction type, the negative/positive parameter of the restriction type, text description of a restriction type.
- 15 It can also add rule(s) to an existing restriction type rule matrix, add group(s) to an existing rule and change
- 16 the sequencing of the rules.

- 1 *For deletion of restrictions*
- 2 The CSD [Central Bank] can delete a restriction type; delete rule(s) and/or group(s) of a restriction type rule
- 3 matrix.
- 4

1 **Table 7-27: Restriction Process Types and Objects Available for Case 2 [T2S.BPD.STD.MRES.01.01]**

Restriction processing	Object	Actor
Blocking	Party	CSD/Central Bank ¹¹⁷
	Security	CSD
	Securities account	CSD
	T2S Dedicated cash account	Central Bank
	RTGS account	Central Bank

2 *For creation of restrictions*

3 The CSD [Central Bank] creates a restriction by defining a restriction type code and description for the
4 “blocking” on the relevant object and set the validity dates of the restriction.

5 No rules have to be defined by the CSD [Central Bank], these restrictions are applied via static data
6 maintenance requests on the object for which the restriction was set-up. However for restrictions “case 2” on
7 Security, it is possible to define a rule based on the ISO transaction type code of the settlement instruction.

8 *For modification of restrictions*

9 The CSD [Central Bank] can modify the validity dates of the restriction type and its description.

10 *For deletion of restrictions*

11 The CSD [Central Bank] can delete the restriction type.

12 **Table 7-28: Restriction Process Types and Objects Available for Case 3 [T2S.BPD.STD.MRES.01.01]**

Restriction processing	Object	Actor
Blocking	Securities position	CSD
	Cash balance	Central Bank
Reservation	Securities position	CSD
	Cash balance	Central Bank
Earmarking	Securities position	CSD

13

¹¹⁷ For their own parties

1 *For creation of restrictions*

2 The CSD [Central Bank] creates a restriction by defining a restriction type code, validity dates and
 3 description. It also specifies the processing type of the restriction type and the relevant object for which the
 4 restriction applies to.

5 To use these restrictions the CSD [Central Bank] will use settlement instructions, settlement restrictions on
 6 securities position or cash balance. Also static data updates are used in the case of earmarking of a securities
 7 account.

8 *For modification of restrictions*

9 The CSD [Central Bank] can modify the validity dates of the restriction and its description.

10 *For deletion of restrictions*

11 The CSD [Central Bank] can delete the restriction type.

12 **Table 7-29: Restriction Process Types and Objects Available for Case 4 [T2S.BPD.STD.MRES.01.01]**

<u>Restriction processing</u>	<u>Object</u>	<u>Actor</u>
<u>Rejection</u>	<u>Securities account</u>	<u>CSD</u>
	<u>Cash account</u>	<u>Central Bank</u>

13 *For creation of restrictions*

14 The CSD [Central Bank] creates the restriction by using the specific restriction type code for these
 15 insolvency procedures, validity dates and description. It also specifies the processing type of the restriction
 16 type and the relevant object for which the restriction applies to.

17 To use this restriction the CSD [Central Bank] will use settlement instructions which debit the insolvency
 18 flagged securities accounts / dedicated cash accounts. Static data updates are produced in both cases.

19 *For modification of restrictions*

20 The CSD [Central Bank] can modify the validity dates of the restriction.

21 *For deletion of restrictions*

22 The CSD [Central Bank] can delete the restriction type.

23

24

25

1 **7.10.3.1.2 Enter Maintenance Request**

Reference ID	T2S.BPD.STD.MRES.01.02
--------------	------------------------

2 The CSD [Central Bank] enters the restriction maintenance details and submit the request to T2S via the
3 GUI.

4 **7.10.3.2 T2S PROCESSING**

5 The **Restriction Management Service (T2S.SD.STD 080)** covers the creation, maintenance and deletion of
6 restriction types and their associated rules and matrices where applicable.

7 **7.10.3.3 MANAGE RESULTS**

Reference ID	T2S.BPD.STD.MRES.02
--------------	---------------------

8 T2S Actors: CSD (Scenario A)/Central Bank (Scenario B)

9 The CSD [Central Bank] views the on-screen message about the validation and processing result of the
10 restriction maintenance request.

11 The CSD [Central Bank] initiates the relevant process on its side based on the outcome of the GUI answer.

12

1 **7.11 MAINTENANCE OF COSD PARAMETERS [T2S.BPD.STDA.MCOS]**

2 **7.11.1 OVERVIEW**

3 This process describes the act of creating, updating and deleting Conditional Securities Delivery (CoSD)
4 rules in T2S. CoSD process allows the CSD to handle exceptions wherein the securities settlement is allowed
5 to take place in T2S upon fulfilment of a settlement condition outside T2S only. For example, free of
6 payment settlement in T2S can be coordinated with cash settlement outside T2S using the CoSD
7 functionality.

8 The CoSD rules are required for identification of settlement instructions that must settle upon successful
9 completion of an additional action or external condition(s) only. The CSD is responsible for the set-up and
10 maintenance of CoSD rules applicable on the settlement instructions owned by the CSD. The CSD must
11 define a date-dependent configuration of CoSD rules and is allowed to modify the CoSD rules intraday.
12 However, the changes to CoSD rules are effective as of a future date only.

13 The Administrating Party is an entity that manages the COSD process and ensures the completion of external
14 condition for the settlement of CoSD impacted settlement instruction in T2S. The CoSD process may require
15 the blocking of resources in T2S before the Administrating Party can initiate the completion of external
16 condition. The Administration Type refers to the CoSD processing condition involving cash only, securities
17 only or both cash and securities.

18 CoSD Rule is a logical set of parameters (one or more) that determine whether a CoSD applies to a
19 settlement instruction. For each CoSD Rule, the CSD may set-up one or more values for a set of
20 parameter(s). A CoSD Rule Matrix refers to a group of values for a CoSD Rule. The CSD may define one or
21 more CoSD Rules and group the CoSD Rules together by Administrating Party and Administration Type. A
22 CoSD Rule Set refers to a group of CoSD Rules and provides the CSD the flexibility to sequence the rules
23 within the rule set.

24 T2S validates the instruction on its intended settlement date or current business date (whichever is later) for
25 applying CoSD rules. The CoSD analysis process analyses all COSD Rule Sets configured by a CSD during
26 the CoSD analysis of a settlement instruction owned by the respective CSD. The CoSD Rules in a CoSD
27 Rule Set are analyzed in the sequence specified in the CoSD Rule Set configuration.

28 The CoSD maintenance process includes all technical activities to maintain the static data information of
29 CoSD (i.e. creation, update, and deletion) depending on whether the data already exists and the intended
30 result.

31 For details on the administration of a Conditional Securities Delivery, refer to process “Administration of
32 Conditional Securities Delivery [T2S.BPD.SETT.COSD]”.

1 **Trigger:**

2 The CSD has identified that certain securities settlement instructions require the fulfilment of an external
3 condition for settlement in T2S

4 **Preconditions:**

5 The CSD must determine the Administrating Party for each CoSD Rule Set and ensure that the
6 Administrating Party has been set-up in T2S.

7 **T2S Instructing Party:**

8 CSD

9 **7.11.2 BUSINESS PROCESS DIAGRAM**

10 **Figure 7-12: Business Process Diagram [T2S.BPD.STDA.MCOS]**

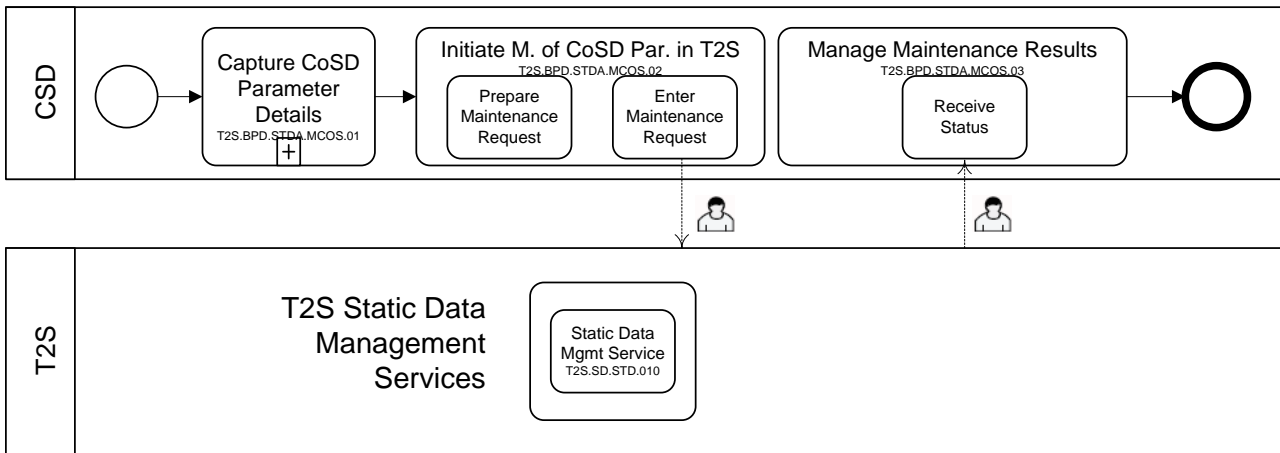

11

12 **7.11.3 BUSINESS PROCESS DESCRIPTION**

13 **7.11.3.1 CAPTURE COSD PARAMETER DETAILS**

Reference ID	T2S.BPD.STDA.MCOS.01
--------------	----------------------

14 T2S Actors: CSD

15 For set-up of CoSD rules in T2S, the CSD must determine the list of configuration parameters and associated
16 values that will uniquely identify the business transaction(s) subjected to CoSD process. Depending upon the
17 external condition to be validated, the CSD determines the Administrating Party and Administration Type. In
18 case of multiple CoSD Rules in a CoSD Rule Set, the CSD also has to determine the sequence in which T2S
19 must validate the CoSD Rules.

20 Core principles for setting up CoSD rules:

- 21 • CoSD Rule Set is unique for a CSD, Administrating Party and Administration Type i.e.

- 1 • Multiple CoSD Rule Sets for a CSD are possible.
- 2 • Each CoSD Rule Set consists of CoSD Rules administered by a single Administrating Party for a
3 specific Administration Type only.
- 4 • A CoSD Rule Set is date dependent.
- 5 • CoSD Rules define the sequence in which T2S will apply a logical set of parameters to determine
6 whether a conditional securities delivery applies. The more restrictive CoSD Rule(s) must be sequenced
7 before the relatively broader CoSD Rules.
- 8 • CoSD Rules Matrix will define the specific parameter values within a rule that T2S will compare to
9 identify whether T2S shall generate a conditional securities delivery.

10 **7.11.3.2 INITIATE MAINTENANCE OF COSD RULES IN T2S**

Reference ID	T2S.BPD.STDA.MCOS.02
--------------	----------------------

11 T2S Actors: CSD

12 The CSD initiates the maintenance of CoSD rules via the T2S GUI. It is not possible to send messages for
13 maintenance of CoSD rule details.

14 References:

15 GUI BFD: T2S.GUI.SDSE.COS.0060, T2S.GUI.SDSE.COS.0050, T2S.GUI.SDSE.COS.0040

16 **7.11.3.2.1 Enter CoSD Maintenance Request**

Reference ID	T2S.BPD.STDA.MCOS.02.01
--------------	-------------------------

17 The CSD enters the CoSD Rule details via T2S GUI and submits the CoSD maintenance request for T2S
18 processing.

19 *For creation of CoSD Rule Sets*

20 The CSD may set-up new CoSD Rules Set by

- 21 • naming a CoSD Rule Set,
- 22 • defining CoSD Rules and CoSD Rule Matrix (rules and the corresponding matrix defining the specific
23 parameter values within a rule) that T2S applies to settlement instruction to identify its settlement as
24 conditional,
- 25 • specifying the Administrating party and
- 26 • defining whether T2S shall block securities positions, cash amount or both when an instruction is marked
27 for conditional delivery (Administration Type).

1 *For amendment of CoSD Rule Sets*

2 The CSD may amend existing CoSD Rule Set by

- 3 • adding rules (rule parameters and associated matrix of parameter values within a CoSD rule),
- 4 • deleting rules,
- 5 • reorder the sequence of CoSD rules for a conditional securities delivery,
- 6 • amend the Administrating Party,
- 7 • and amend the Administration Type.

8 *For deletion of CoSD Rule Sets*

9 The CSD may delete a CoSD Rule Set.

10 **7.11.3.3 T2S PROCESSING**

11 The **Static Data Management Service (T2S.SD.STD.010)** validates the incoming request entered via the
 12 GUI and shows the acceptance or rejection of the request on the screen. It also triggers the
 13 creation/update/deletion of the CoSD rule sets.

14 **7.11.3.4 MANAGE MAINTENANCE RESULTS**

Reference ID	T2S.BPD.STDA.MCOS.03
--------------	----------------------

15 T2S Actors: CSD

16 The CSD views in the results in the T2S GUI.

17 **7.11.3.4.1 Receive Status**

Reference ID	T2S.BPD.STDA.MCOS.03.01
--------------	-------------------------

18 The CSD views the on-screen message about the completion or rejection of the CoSD maintenance request.

19 Other internal activities might be conducted.

20

1 **7.12 MAINTENANCE OF CROSS-CSD SETTLEMENT LINK AND SECURITIES** 2 **ELIGIBILITY [T2S.BPD.STDA.MCSL]**

3 **7.12.1 OVERVIEW**

4 This process describes the act of creating, updating and deleting cross CSD settlement links and securities
5 eligibility static data in T2S.

6 The Security CSD Link business object stores information about the security's settlement eligibility in T2S.
7 A CSD in T2S must set-up in T2S static data, the securities eligible for settlement in the respective CSD.
8 This business object also stores information regarding the Securities Maintaining Entity for a security.

9 The Security CSD Link, CSD Account Link and Eligible Counterpart CSD business objects store
10 information about the cross CSD settlement links. Apart from the securities settlement eligibility details, the
11 Security CSD Link business object also stores information about the bilateral links between the CSDs for
12 settlement of a specific security. CSDs in T2S can be categorised as Investor CSD and Issuer CSD. An
13 Investor CSD may maintain either direct or indirect links with the Issuer CSD. In case the Investor CSD
14 maintains a direct link with the Issuer CSD, then the Issuer CSD is defined as the Technical Issuer CSD for
15 the Investor CSD for a specific security. In case of indirect links, an Investor CSD may use another Investor
16 CSD that has a direct link with the Issuer CSD, as its Technical Issuer CSD and thereby maintain an indirect
17 link with the Issuer CSD. An Issuer CSD on the other hand, acts as a Technical Issuer CSD for itself.
18 Optionally, the issuance account for a given ISIN can be specified in the Security CSD Link. When one or
19 more Issuance accounts are defined for a given ISIN, at least one of them will have to be marked as the
20 "primary" Issuance account to be used for realignment.

21 The CSD Account Link business object stores information about the relationship between the Investor CSD
22 and its Technical Issuer CSD accounts (i.e., participant, mirror and inter-CSD accounts in Investor CSD and
23 omnibus account in Technical Issuer CSD). During a cross CSD settlement involving participants of the two
24 CSDs that have a direct / indirect link with each other, T2S automatically realigns the securities positions
25 held in the participant and technical accounts. There is no need of additional procedures to be carried out by
26 the involved CSDs for realignment of securities positions.

27 The Eligible Counterpart CSD business object stores information about the eligibility of settlement between
28 two CSD for a specific security or set of securities grouped by country of issuance.

29 All the business objects described above are required for enabling intra-CSD and cross CSD settlements in
30 T2S. T2S instruction validation process references the Eligible Counterpart CSD business object for cross
31 CSD settlements and the Security CSD Link business object to determine the eligibility of security for
32 settlement in the CSD. T2S realignment process references the Security CSD Link and CSD Account Link
33 business object for building the realignment chain between the selling and buying CSDs.

1 The cross CSD settlement links and securities eligibility maintenance process includes all technical activities
2 to maintain the static data information of cross CSD settlement links and securities eligibility (i.e. creation,
3 update, and deletion) depending on whether the data already exists and the intended result.

4 **Trigger:**

5 For the set-up of a security's CSD settlement eligibility in T2S,

- 6 • For an Issuer CSD or a Securities Maintaining Entity "SME" (an Investor CSD in case the Issuer CSD is
7 outside T2S), this process is initiated along with the process of securities creation in T2S.
- 8 • For an Investor CSD (other than the "SME"), this process is initiated when a new security is available
9 for settlement in the CSD books.
- 10 • Change of "Issuer CSD".

11 For the set-up of cross CSD settlement links in T2S,

- 12 • The CSD establishes contractual agreement with the other CSD(s) for providing cross CSD securities
13 settlement services.

14 **Preconditions:**

15 For the set-up a security's CSD settlement eligibility in T2S, the prerequisite is the existence of securities
16 reference data in T2S. For CSD links involving CSD outside T2S, the Investor or Issuer CSD in T2S that
17 maintains direct link with the CSD outside T2S must complete the set-up of the CSD outside T2S as an
18 External CSD¹¹⁸ in T2S.

19 For cross CSD settlement link information, the prerequisite within T2S is the creation of mirror and inter-
20 CSD accounts in Investor CSD and omnibus account in Technical Issuer CSD. In addition, the two CSDs
21 must have a contractual relationship with each other outside T2S.

22 The creation of link reference data is possible intra-day; however, the update or deletion is only allowed as of
23 a future date.

24 **T2S Instructing Party:**

25 CSD

¹¹⁸ External CSDs are CSDs that do not exist in T2S at level 2 of the T2S party hierarchy data model. Such CSD are defined as *External CSD* (i.e. CSD Participant type) by the CSD in T2S that maintain direct links with them.

1 **7.12.2 BUSINESS PROCESS DIAGRAM**

2 **Figure 7-13: Business Process Diagram [T2S.BPD.STDA.MCSL]**

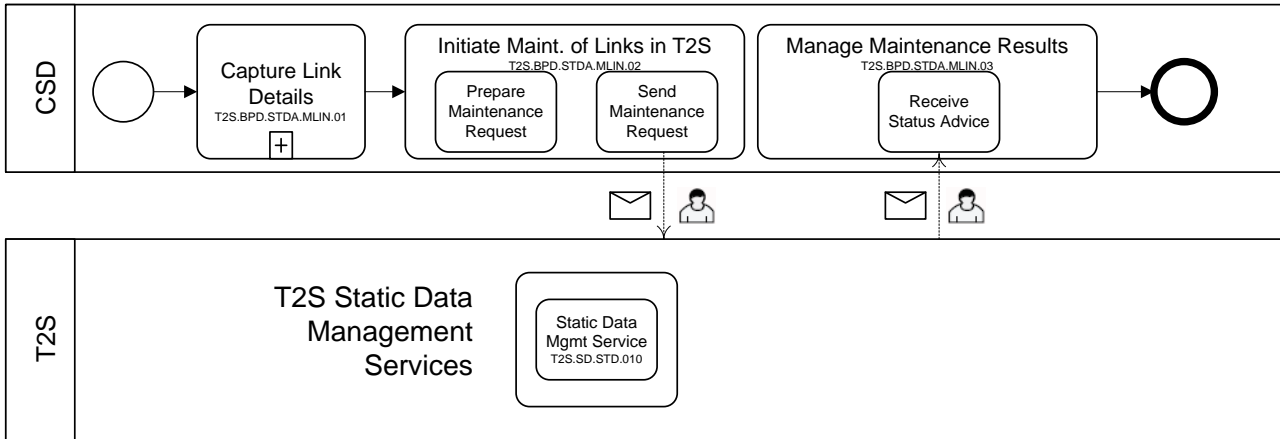

3

4 **7.12.3 BUSINESS PROCESS DESCRIPTION**

5 **7.12.3.1 CAPTURE LINK DETAILS**

Reference ID	T2S.BPD.STDA.MCSL.01
--------------	----------------------

6 T2S Actors: CSD

7 For a security’s settlement eligibility in a CSD, the CSD performs all procedures to meet its business, legal
 8 and regulatory requirements for allowing a security to settle in its books. The CSD may also specify itself as
 9 the Securities Maintaining Entity for the security in the Security CSD Link business object. The CSD may
 10 also conduct additional steps to determine the Technical Issuer CSD for a security. While the Issuer CSD(s)
 11 of a security is the Technical Issuer CSD for itself, an Investor CSD (in T2S) has to identify the Technical
 12 Issuer CSD for a specific security¹¹⁹.

13 For cross CSD settlement links, the CSD (acting as Investor CSD) collects information about the relationship
 14 between the securities account(s) in the Investor CSD books and the Technical Issuer CSD¹²⁰. The CSD
 15 ensures that the securities accounts have been set-up in the respective CSDs and the contractual agreement(s)
 16 necessary for bilateral links between the CSDs have been completed and are effective.

17 For set-up of eligible counterpart CSDs in T2S, the CSD identifies all the counterpart CSDs with whom its
 18 participants can settle trades for specific security or a group of securities by issuance country. It is not

¹¹⁹ In case the Technical Issuer CSD is outside T2S, then the Investor CSD has to set-up the Technical Issuer CSD as a party in T2S at the Level 3 of the T2S party hierarchy data model with party type as *External CSD*. For Investor CSDs outside T2S, the Technical Issuer CSD (in T2S) has to set-up the Investor CSD as a party in T2S at the Level 3 of the T2S party hierarchy data model with party type as *External CSD* (see BPD on *Maintenance of Parties*)

¹²⁰ Depending upon whether the Investor CSD or its Technical Issuer CSD is in T2S or out of T2S, some securities accounts may not exist in T2S

1 necessary that direct links exist between the counterparty CSDs. There may be single or multiple CSDs
 2 acting as intermediary CSD between the counterparty CSDs.

3 **7.12.3.2 INITIATE MAINTENANCE OF LINKS IN T2S**

Reference ID	T2S.BPD.STDA.MCSL.02
--------------	----------------------

4 T2S Actors: CSD

5 The CSD uses the cross-CSD settlement link and securities settlement eligibility details to create a
 6 maintenance instruction for the business objects (i.e. Security CSD Link, CSD Account Link and Eligible
 7 Counterpart CSD) and sends the instruction to T2S.

8 References:

9 UDFS: Use Case “Maintain SD” (Chapter 2.20)

10 GUI BFD:

11 *For creation of link reference data*

12 Security CSD Link (T2S.GUI.SDSE.SCL.0060)

13 CSD Account Link (T2S.GUI.SDSE.CSA.0060)

14 Eligible Counterpart CSD (T2S.GUI.SDSE.ECC.0060)

15 *For amendment of link reference data*

16 Security CSD Link (T2S.GUI.SDSE.SCL.0040)

17 CSD Account Link (T2S.GUI.SDSE.CSA.0040)

18 Eligible Counterpart CSD (T2S.GUI.SDSE.ECC.0040)

19 *For deletion of link reference data*

20 Security CSD Link (T2S.GUI.SDSE.SCL.0050)

21 CSD Account Link (T2S.GUI.SDSE.CSA.0050)

22 Eligible Counterpart CSD (T2S.GUI.SDSE.ECC.0050)

23 **7.12.3.2.1 Preparation Maintenance Request**

Reference ID	T2S.BPD.STDA.MCSL.02.01
--------------	-------------------------

24 The CSD collects the cross CSD settlement link maintenance details and prepares the cross CSD settlement
 25 link maintenance instruction.

1 *For creation of link reference data*

2 The creation of cross CSD settlement link is performed by a CSD.

3 All the business objects related to cross CSD settlement links can be created intraday wherein the valid from
4 date can be a future business date or the same day.

5 The CSD Account Link business object can be created in the U2A mode only while the Eligible Counterpart
6 CSD and Security CSD Link business objects can be created in both U2A and A2A modes.

7 In case the Investor CSD has defined a mandatory market specific attribute for a security and does not
8 provide any value for the attribute during security creation, T2S will reject the creation of a new Security
9 CSD link from this Investor CSD.

10 When creating security CSD link, it is also possible to specify the Issuance account(s) for this ISIN. In case
11 of multi-issued securities, this is mandatory to provide at least one “primary” Issuance account as this
12 account will be used in case of cross-CSD settlement where the two Issuer CSDs in T2S are the technical
13 issuers of Investor CSDs. T2S will also check for any settlement on these accounts, that the ISIN can be
14 settled on this account.

15 *For amendment of link reference data*

16 The amendment of cross CSD settlement links is performed by the CSD.

17 All the business objects related to cross CSD settlement links can be amended intraday wherein the valid
18 from date can be a future business date only.

19 The CSD Account Link and Eligible Counterpart CSD business objects can be amended in U2A mode only
20 while the Security CSD Link can be updated also in A2A (e.g. closing of security CSD link only is allowed).

21 *For deletion of link reference data*

22 The deletion of cross CSD settlement links is performed by the CSD.

23 All the business objects related to cross CSD settlement links can be deleted intraday wherein the valid from
24 date can be a future business date only.

25 The Security CSD Link, CSD Account Link and Eligible Counterpart CSD business objects can be deleted in
26 U2A mode only.

27 **7.12.3.2.2 Send Static Data Maintenance Request**

Reference ID	T2S.BPD.STDA.MCSL.02.02
--------------	-------------------------

28 For the creation of Eligible Counterpart CSD and Security CSD Link reference data the maintenance
29 activities can be initiated via A2A mode. In this case, the CSD formats the maintenance instruction

1 depending upon the type of maintenance action (i.e. creation of Eligible Counterparty CSD) and sends the
 2 maintenance instruction to the T2S.

3 For maintenance activities initiated via U2A mode, the CSD enter details and submit the maintenance
 4 request online.

5 The CSD sends the following message to T2S:

6 **Table 7-30: Messages to T2S [T2S.BPD.STDA.MCSL.02.02]**

Message Name	ISO Code	To/From T2S	UDFS Chapter
EligibleCounterpartCSD CreationRequestV01	reda.026.001.01	To T2S	3.3.6.20
SecurityCSDLinkCreatio nRequestV01	reda.045.001.01	To T2S	3.3.6.39

7 **7.12.3.3 T2S PROCESSING**

8 The **Static Data Management Service (T2S.SD.STD.010)** validates the incoming request entered via the
 9 GUI and shows the acceptance or rejection of the request on the screen. It also triggers the
 10 creation/update/deletion of the link reference data.

11 **7.12.3.4 MANAGE MAINTENANCE RESULTS**

Reference ID	T2S.BPD.STDA.MCSL.03
--------------	----------------------

12 T2S Actors: CSD

13 The CSD receives status advice messages from T2S or views the status in the T2S GUI.

14 For security CSD links, the maintenance (e.g. closing) is available in A2A also:

15 **Table 7-30: Messages to T2S [T2S.BPD.STDA.MCSL.02.02]**

Message Name	ISO Code	To/From T2S	Event	UDFS Chapter
SecurityCSDLink MaintenanceReque stV01	reda.046.001.01	From T2S		3.3.6.40

16

17 **7.12.3.4.1 Receive Status Advice**

Reference ID	T2S.BPD.STDA.MCSL.03.01
--------------	-------------------------

1 For the creation of Eligible Counterpart CSD and Security CSD Link reference data the maintenance
 2 activities can be initiated via A2A mode. In this case, the CSD receives the maintenance instruction status
 3 advice.

4 For maintenance activities initiated via U2A mode, the CSD views the status of the maintenance request in
 5 the T2S GUI.

6 The CSD receives the following message from T2S:

7 **Table 7-31: Messages from T2S [T2S.BPD.STDA.MCSL.03]**

Message Name	ISO Code	To/From T2S	Event	UDFS Chapter
EligibleCounterpart CSDStatusAdvice V01	reda.044.001.01	From T2S		3.3.6.38
SecurityCSDLinkS tatusAdviceV01	reda.047.001.01	From T2S		3.3.6.41

8

1 **7.13 MAINTENANCE OF MULTIPLE LIQUIDITY PROVIDERS**
2 **[T2S.BPD.STDA.MMLP]**

3 **7.13.1 OVERVIEW**

4 This process describes the act of creating, updating and deleting Multiple Liquidity Provider data in T2S. A
5 Central Bank and/or a Payment Bank can have a dedicated cash account in T2S to facilitate securities
6 settlement for itself or to its client(s) to which it provides cash settlement services. Some examples of such
7 securities settlement are trade settlement, Repo, Securities lending and borrowing, etc. For these purposes, a
8 Central Bank and/or a Payment Bank funds liquidity in its dedicated cash account in T2S. Such a funding of
9 the T2S dedicated cash accounts can be from one or more liquidity providers in the RTGS, at the start of a
10 business day in T2S. The funds available in a T2S dedicated cash account prior to the start of night-time
11 settlement (NTS) will be made use for the settlement of transactions in night-time settlement sequences.

12 A Payment Bank in T2S can optionally decide to reimburse the funds to its relevant liquidity providers
13 towards the end of the night-time settlement (i.e. with settlement sequence Y) based on relevant standing
14 liquidity transfers and a prioritised sequence of reimbursement via order link set.

15 **Trigger:**

16 Need of a Payment Bank for an automated retransfer funds at the end of night-time settlement in T2S to the
17 liquidity providers in RTGS

18 **Preconditions:**

19 The needed standing liquidity transfer orders are defined in T2S

20 **T2S Instructing Party:**

21 There are two scenarios for the instruction of T2S:

- 22 • Scenario A: Central Bank instructs T2S.
23 • Scenario B: Payment Bank instructs T2S.

1 **7.13.2 BUSINESS PROCESS DIAGRAM**

2 **Figure 7-14: Business Process Diagram [T2S.BPD.STDA.MMLP]**

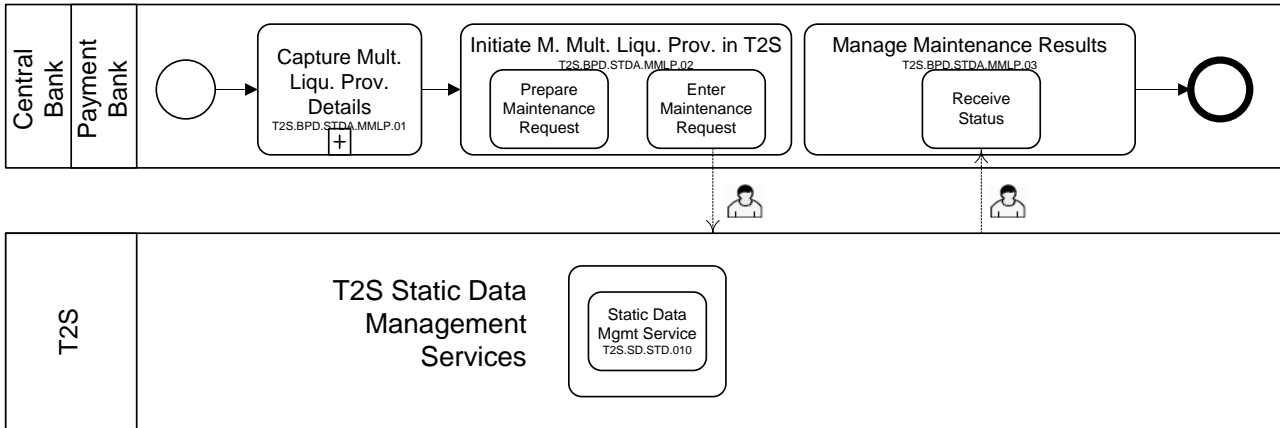

3

4 **7.13.3 BUSINESS PROCESS DESCRIPTION**

5 **7.13.3.1 CAPTURE MULTIPLE LIQUIDITY PROVIDER MAINTENANCE REQUEST**

Reference ID	T2S.BPD.STDA.MMLP.01
--------------	----------------------

6 T2S Actors: Central Bank (Scenario A)/Payment Bank (Scenario B)

7 The Central Bank [Payment Bank] decides to create, modify or delete multiple liquidity provider details in
8 T2S static data. These details include

- 9 • standing liquidity transfer orders,
10 • order link set¹²¹.

11 The Central Bank [Payment Bank] checks all the details received from its clients against the reference data
12 maintained by itself and may perform additional checks/validations using query facilities in RTGS and/or
13 T2S.

14 **7.13.3.2 INITIATE MAINTENANCE OF ORDER LINK SET IN T2S**

Reference ID	T2S.BPD.STDA.MMLP.02
--------------	----------------------

15 T2S Actors: Central Bank (Scenario A)/Payment Bank (Scenario B)

16 The Central Bank [Payment Bank] enriches the maintenance of order link set request with details required in
17 T2S and placing the maintenance request in T2S using the T2S GUI.

¹²¹ The order link set includes a set of standing liquidity transfer orders with a defined sequence of execution during the reimbursement of multiple liquidity provider process

1 References:

2 GUI BFD: See section 4.12 to query and maintain “Order link set” in T2S via the T2S GUI,
 3 T2S.GUI.SDSE.MLP.0010, T2S.GUI.SDSE.MLP.0020, T2S.GUI.SDSE.MLP.0030,
 4 T2S.GUI.SDSE.MLP.0040, T2S.GUI.SDSE.MLP.0050, T2S.GUI.SDSE.MLP.0060

5 **7.13.3.2.1 Prepare Maintenance Request**

Reference ID	T2S.BPD.STDA.MMLP.02.01
---------------------	--------------------------------

6 The Central Bank [Payment Bank] identifies and enriches the maintenance request using specific information
 7 such as:

- 8 • the T2S party identifiers,
- 9 • the debit T2S dedicated cash accounts (of the Payment Bank) and credit RTGS accounts (of the liquidity
 10 providers to be reimbursed),
- 11 • the identification of the standing liquidity transfer orders,
- 12 • sequence of execution of standing liquidity transfer orders.

13 The Central Bank [Payment Bank] might want to use the query facilities in RTGS and/or T2S to get the
 14 necessary information.

15 **7.13.3.2.2 Enter Maintenance Request**

Reference ID	T2S.BPD.STDA.MMLP.02.02
---------------------	--------------------------------

16 The Central Bank [Payment Bank] converts the maintenance request enriched with specific information to
 17 the format specified by T2S and captures the maintenance request via the T2S GUI. The processing of the
 18 “order link set” maintenance request in T2S depends on the values specified in the request.

19 **7.13.3.3 T2S PROCESSING**

20 The **Static Data Management Service (T2S.SD.STD.010)** validates the incoming request entered via the
 21 GUI and shows the acceptance or rejection of the request on the screen. It also triggers the
 22 creation/update/deletion of the order link set.

23 **7.13.3.4 MANAGE MAINTENANCE RESULTS**

Reference ID	T2S.BPD.STDA.MMLP.03
--------------	----------------------

24 T2S Actors: Central Bank (Scenario A)/Payment Bank (Scenario B)

25 The Central Bank [Payment Bank] can view the status in the T2S GUI.

1 References:

2 GUI BFD: See section 4.12 to query and maintain “Order link set” in T2S via the T2S GUI,
3 T2S.GUI.SDSE.MLP.0010, T2S.GUI.SDSE.MLP.0020, T2S.GUI.SDSE.MLP.0030,
4 T2S.GUI.SDSE.MLP.0040, T2S.GUI.SDSE.MLP.0050, T2S.GUI.SDSE.MLP.0060

5 **7.13.3.5 RECEIVE STATUS**

Reference ID	T2S.BPD.STDA.MMLP.03.01
--------------	-------------------------

6 The Central Bank [Payment Bank] receives the status of the validation and processing in the T2S GUI and
7 initiates relevant internal processes.

8

1 7.14 MAINTENANCE OF STANDING/PREDEFINES LIQUIDITY TRANSFER 2 ORDERS [T2S.BPD.STDA.MLTO]

3 7.14.1 OVERVIEW

4 This process describes the act of creating, updating and deleting data on Standing/redefined Liquidity
5 Transfer Orders in T2S. A Payment Bank as a client of a Central Bank can have a dedicated cash account in
6 T2S to facilitate securities settlement for itself or to its client(s) to which it provides cash settlement services.
7 Some examples of such securities settlement are trade settlement, Repo, Securities lending and borrowing,
8 etc. For these purposes, a Payment Bank funds liquidity in its dedicated cash account in T2S. Such a funding
9 of the T2S dedicated cash accounts can be from one or more liquidity providers in the RTGS, for use in
10 securities settlement, at any time during a business day in T2S.

11 A Payment Bank in T2S can optionally decide to retransfer the funds to its relevant liquidity providers at any
12 time (e.g. 3.00 p.m. CET) or on the occurrence of a business event during a business day. Some examples of
13 the business events are:

- 14 • “Corporate action rebalancing liquidity (CARL)” where the cash proceeds resulting on a T2S dedicated
15 cash account due to a corporate action has to be retransferred to the relevant RTGS account.
- 16 • Similarly “monetary policy operation” where the cash proceeds resulting on a T2S dedicated cash
17 account due to a monetary policy operation has to be retransferred to the relevant RTGS account.
- 18 • “End of night-time settlement” for reimbursement of multiple liquidity providers.
- 19 • “End of automatic reimbursement of auto-collateralisation”.

20 T2S facilitates the Payment Bank for such a need with the maintenance of standing or predefined liquidity
21 transfer orders.

- 22 • When a Payment Bank needs such a retransfer of funds to occur only once, then it can setup a predefined
23 liquidity transfer order.
- 24 • When a Payment Bank needs such a retransfer of funds to occur repetitively, it can setup a standing
25 liquidity transfer order (Only one per day for a given time/event per DCA).

26 The maintenance activities shall include creation/ update/ deletion of such liquidity transfer orders in T2S.
27 This process covers such needs as “Maintain standing/ predefined liquidity transfer orders” with the standard
28 steps within the context of a Central Bank.

29 **Trigger:**

30 The Central Bank or Payment Bank identifies the need of an automated retransfer of funds from a T2S
31 dedicated cash account to an RTGS account.

1 **Precondition:**

2 None

3 **T2S Instructing Party:**

4 There are two scenarios for the instruction of T2S:

- 5 • Scenario A: Central Bank instructs T2S.
- 6 • Scenario B: Payment Bank instructs T2S.

7 **7.14.2 BUSINESS PROCESS DIAGRAM**

8 **Figure 7-15: Business Process Diagram [T2S.BPD.STDA.MLTO]**

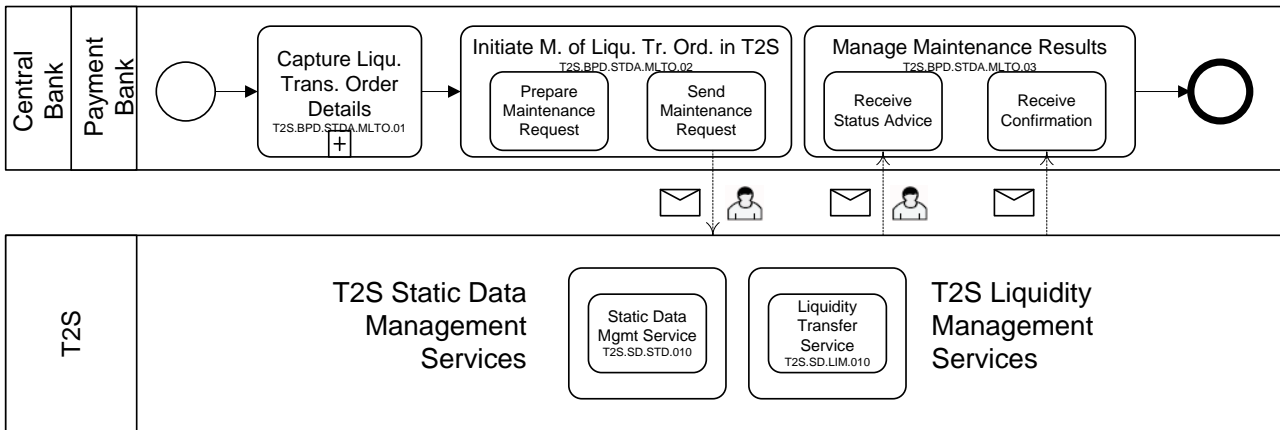

10 **7.14.3 BUSINESS PROCESS DESCRIPTION**

11 **7.14.3.1 CAPTURE LIQUIDITY TRANSFER ORDER DETAILS**

Reference ID	T2S.BPD.STDA.MLTO.01
--------------	----------------------

12 T2S Actors: Central Bank (Scenario A)/Payment Bank (Scenario B)

13 This process starts when the Central Bank [Payment Bank] decides to create, modify or delete¹²² predefined
 14 or standing liquidity transfer orders intending to retransfer liquidity from a T2S dedicated cash account of a
 15 Payment Bank in T2S to an RTGS account.

16 The Central Bank [Payment Bank] checks all the details received from its clients related to maintenance of
 17 liquidity transfer order against the reference data maintained by itself and may perform additional
 18 checks/validations using query facilities in RTGS and/or T2S.

¹²² Deletion of a predefined or standing liquidity transfer order is possible via U2A only

1 **7.14.3.2 INITIATE MAINTENANCE OF LIQUIDITY TRANSFER ORDER IN T2S**

Reference ID	T2S.BPD.STDA.MLTO.02
--------------	----------------------

2 T2S Actors: Central Bank (Scenario A)/Payment Bank (Scenario B)

3 The Central Bank [Payment Bank] enriches the maintenance of liquidity transfer order request with details
 4 required in T2S and sends the maintenance request to T2S using an A2A message (or) by placing the
 5 maintenance request in T2S using the T2S GUI via U2A.

6 References:

7 UDFS: Use Case “Maintain Static Data” (Chapter 2.20)

8 GUI BFD: See section 4.11 to query and maintain “Liquidity Transfer Orders” in T2S via the T2S GUI,
 9 T2S.GUI.SDSE.LTO.0010, T2S.GUI.SDSE.LTO.0020, T2S.GUI.SDSE.LTO.0030,
 10 T2S.GUI.SDSE.LTO.0040, T2S.GUI.SDSE.LTO.0050, T2S.GUI.SDSE.LTO.0060

11 **7.14.3.2.1 Prepare Maintenance Request**

Reference ID	T2S.BPD.STDA.MLTO.02.01
--------------	-------------------------

12 The Central Bank [Payment Bank] enriches the maintenance request with specific information such as:

- 13 • the T2S party identifiers,
- 14 • the T2S dedicated cash account as the debit account,
- 15 • the RTGS account as the credit account,
- 16 • the specific transferable amount (or) all cash indicator,
- 17 • type of order (i.e. predefined or standing order),
- 18 • trigger event (i.e. either a time or business event trigger).

19 The Central Bank [Payment Bank] might want to use the query facilities in RTGS and/or T2S to get the
 20 necessary information.

21 **7.14.3.2.2 Send Maintenance Request**

Reference ID	T2S.BPD.STDA.MLTO.02.02
--------------	-------------------------

22 The Central Bank [Payment Bank] converts the maintenance request enriched with specific information to
 23 the format specified by T2S and transmits it to T2S.

24 The instruction of T2S is also possible via the T2S GUI.

1 The processing of the “predefined or standing liquidity transfer order” maintenance request in T2S depends
 2 on the values specified in the request.

3 The Central Bank [Payment Bank] sends the following message to T2S:

4 **Table 7-32: Messages to T2S [T2S.BPD.STDA.MLTO.02.02]**

Message Name	ISO Code	To/From T2S	UDFS Chapter
ModifyStandingOrder	Camt.024.001.04	To T2S	3.3.3.11

5 **7.14.3.3 T2S PROCESSING**

6 The **Static Data Management Service (T2S.SD.STD.010)** validates the incoming request
 7 (ModifyStandingOrder). The **Liquidity Transfer Service (T2S.SD.LIM.010)** triggers the
 8 creation/update/deletion of the “predefined or standing liquidity transfer order”. The **Static Data**
 9 **Management Service (T2S.SD.STD.010)** then sends the related status advice (Receipt) and confirmation
 10 (Receipt).

11 **7.14.3.4 MANAGE MAINTENANCE RESULTS**

Reference ID	T2S.BPD.STDA.MLTO.03
--------------	----------------------

12 T2S Actors: Central Bank (Scenario A)/Payment Bank (Scenario B)

13 The Central Bank [Payment Bank] receives the maintenance related messages and can initiate related
 14 internal processes.

15 References:

16 UDFS: Use Case “Maintain Static Data” (Chapter 2.20)

17 GUI BFD: See section 4.11 to query and maintain “Liquidity Transfer Orders” in T2S via the T2S GUI,
 18 T2S.GUI.SDSE.LTO.0010, T2S.GUI.SDSE.LTO.0020, T2S.GUI.SDSE.LTO.0030,
 19 T2S.GUI.SDSE.LTO.0040, T2S.GUI.SDSE.LTO.0050, T2S.GUI.SDSE.LTO.0060

20 **7.14.3.4.1 Receive Status Advice**

Reference ID	T2S.BPD.STDA.MLTO.03.01
--------------	-------------------------

21 The Central Bank [Payment Bank] receives status advice messages for every change of status code to the
 22 “predefined or standing liquidity transfer order” maintenance request in T2S for the results of the validation/
 23 processing of the static data maintenance request.

24 If T2S has been instructed via the T2S GUI the status is shown on the screen.

1 Subsequently, other internal activities might be conducted such as:

- 2 • aligning the status of the “predefined or standing liquidity transfer order” maintenance request in the
- 3 Central Bank or the Payment Bank’s systems with the status in T2S,
- 4 • triggering notification to their relevant clients.

5 The Central Bank [Payment Bank] receives the following message from T2S:

6 **Table 7-33: Messages from T2S [T2S.BPD.STDA.MLTO.03.01]**

Message Name	ISO Code	To/From T2S	Event	UDFS Chapter
Receipt	Camt.025.001.03	From T2S	T2S “Rejects” or “Queues” the “predefined or standing liquidity transfer order” maintenance request	3.3.3.12

7 **7.14.3.4.2 Receive Confirmation**

Reference ID	T2S.BPD.STDA.MLTO.03.02
--------------	-------------------------

8 The Central Bank [Payment Bank] receives and validates the confirmation of the processing of “predefined
9 or standing liquidity transfer order” maintenance request.

10 Subsequently, other internal activities might be conducted such as:

- 11 • aligning the status of the maintenance request in the Central Bank or the Payment Bank’s books with the
- 12 status in T2S,
- 13 • triggering notification to their relevant clients.

14 The Central Bank [Payment Bank] receives the following message from T2S:

15

1 **Table 7-34: Messages from T2S [T2S.BPD.STDA.MLTO.03.02]**

Message Name	ISO Code	To/From T2S	Event	UDFS Chapter
Receipt	Camt.025.001.03	From T2S	T2S “completes” the “predefined or standing liquidity transfer order” maintenance request	3.3.3.12

2

1 7.15 MAINTENANCE OF AUTO-COLLATERALISATION ELIGIBILITY 2 [T2S.BPD.STDA.MACE]

3 7.15.1 OVERVIEW

4 This process describes the act of creating, updating and deleting data referring to auto-collateralisation
5 eligibility in T2S. Central Banks, its Payment Banks and clients of Payment Banks can use the auto-
6 collateralisation facilities in T2S to facilitate the securities settlement transactions, when there is lack of cash.
7 The credit provider must identify the eligible clients (i.e. Payment Banks/ clients of Payment Banks) to use
8 the facility in T2S.

- 9 • T2S triggers auto-collateralisation with central banks when a Payment Bank lacks cash to process a
10 Settlement Instruction.
- 11 • T2S triggers auto-collateralisation with Payment Banks (otherwise known as client-collateralisation) for
12 the owner of a securities account involved in a Settlement Instruction, when the client of the Payment
13 Bank lacks external guarantee headroom.

14 Central Banks and Payment Banks are responsible for defining the eligibility for auto-collateralisation
15 purpose. The setup of the auto-collateralisation feature in T2S includes the configuration and maintenance
16 of:

- 17 • Auto-collateralisation rules i.e. maximum credit percentage, the type of collateralisation procedure,
18 information specifying whether the Central Bank uses the maximum credit percentage for the
19 implementation of auto-collateralisation operations,
- 20 • Eligible Counterparties i.e. a list of “eligible parties” to which a Central Bank or a Payment Bank can
21 provide auto-collateralisation facilities in T2S,
- 22 • Securities auto-collateralisation eligibility for the “eligible assets”, i.e. the specification of which
23 financial instruments are eligible as collateral against provision of credit in a given currency,
- 24 • Securities valuation, i.e. the specification of the prices that T2S can use for the valuation of securities
25 positions, when triggering the auto-collateralisation process for the relevant currency,
- 26 • Close-links, i.e. the specification of securities not used as collateral by a party (having a close link with
27 the issuer of the securities) in an auto-collateralisation process though it might be eligible.

28 Additionally, Central Banks and Payment Banks can also maintain concentration limits for a list of eligible
29 assets. T2S in its current scope does not support the processing of such information on concentration limits.

30 For details on the management of auto-collateralisation within the settlement process, refer to process
31 “Management of Auto-Collateralisation [T2S.BPD.SETT.ACOL]”.

1 **Trigger:**

2 The following triggers can initiate this business process

3 • A Central Bank may need to manage the auto-collateralisation eligibility information in T2S due to the
4 following reasons

5 ○ Its Payment Bank needs a certain maintenance of its auto-collateralisation (i.e. client-
6 collateralisation) rules.

7 ○ A client of a Central Bank or Payment Bank needs auto-collateralisation facilities in T2S.

8 • A Central Bank and/or the Payment Banks can provide the following information on a daily basis, either
9 directly or indirectly via a collateral management system to T2S. Further they can update this
10 information only when changes occur or when it receives a certain update from its sources

11 ○ securities auto-collateralisation eligibility,

12 ○ close-links information,

13 ○ securities prices for valuation purposes.

14 This involves the below sub-processes, which take place independently of each other

15 • Maintenance of auto-collateralisation rules

16 • Maintenance of eligible counterparties

17 • Maintenance of securities auto-collateralisation eligibility

18 • Maintenance of securities prices for valuation purposes

19 • Maintenance of close-links information

20

1 **7.15.2 BUSINESS PROCESS DIAGRAM**

2 *Maintenance of auto-collateralisation rules*

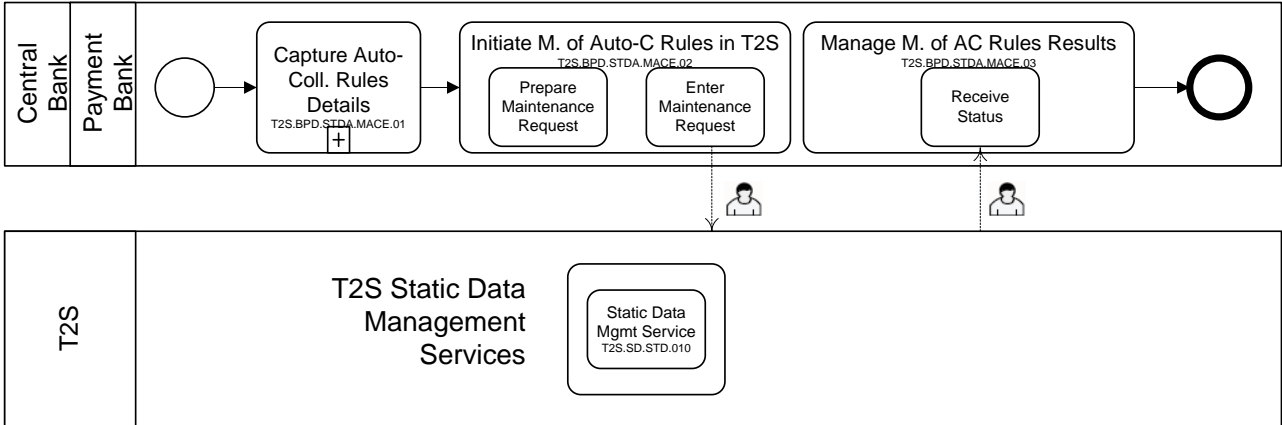

3

4 *Maintenance of eligible counterparties*

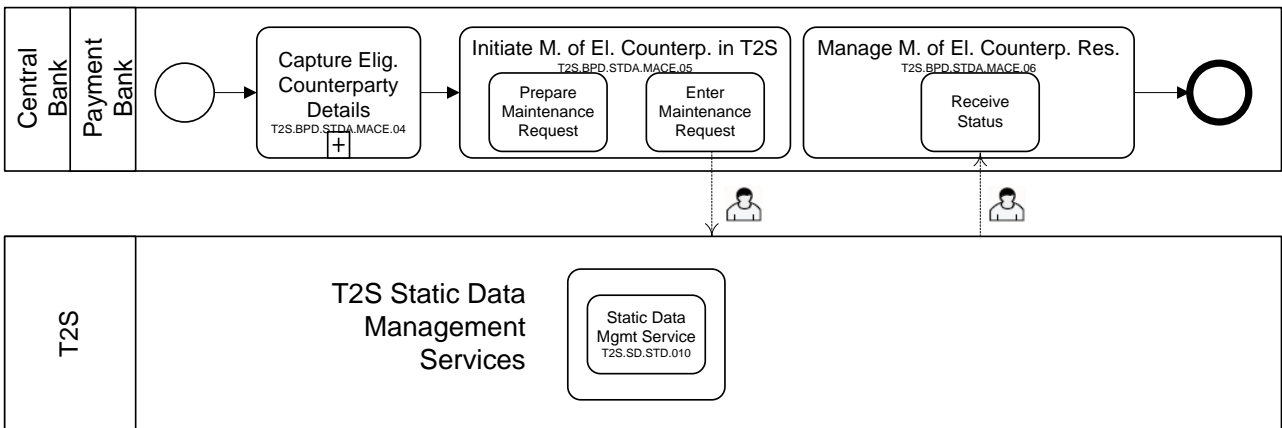

5

6 *Maintenance of securities auto-collateralisation eligibility*

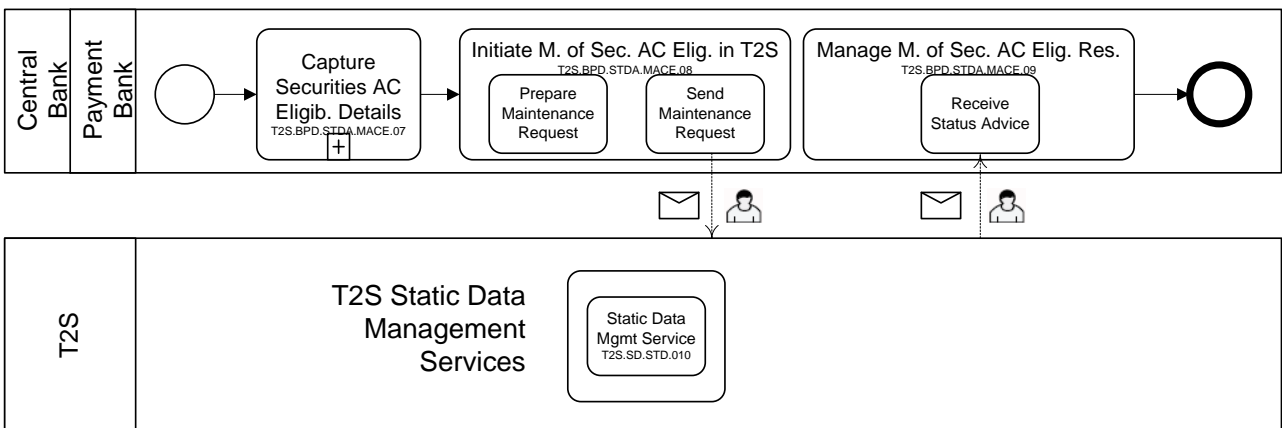

7

8

1 *Maintenance of securities prices for valuation purposes*

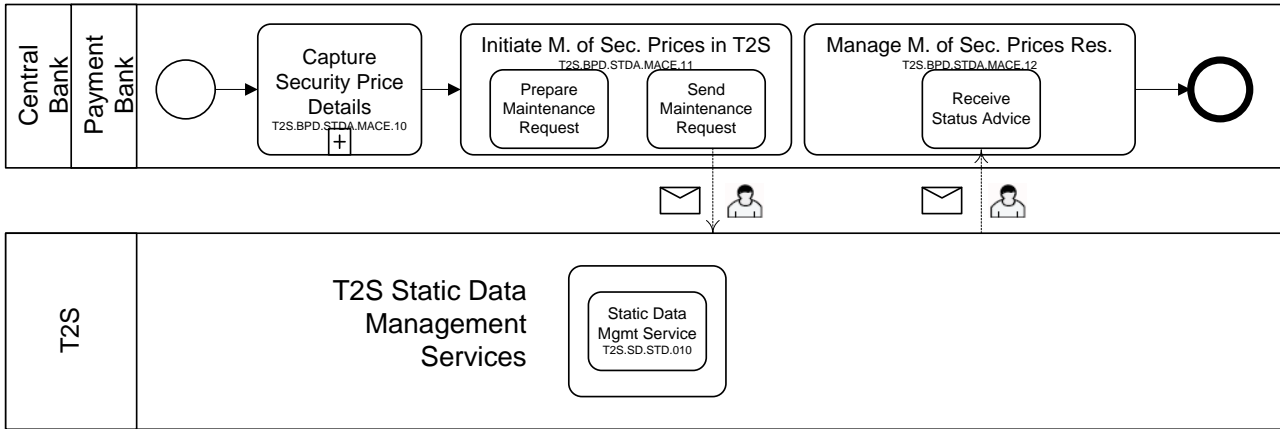

2

3 *Maintenance of close-links information*

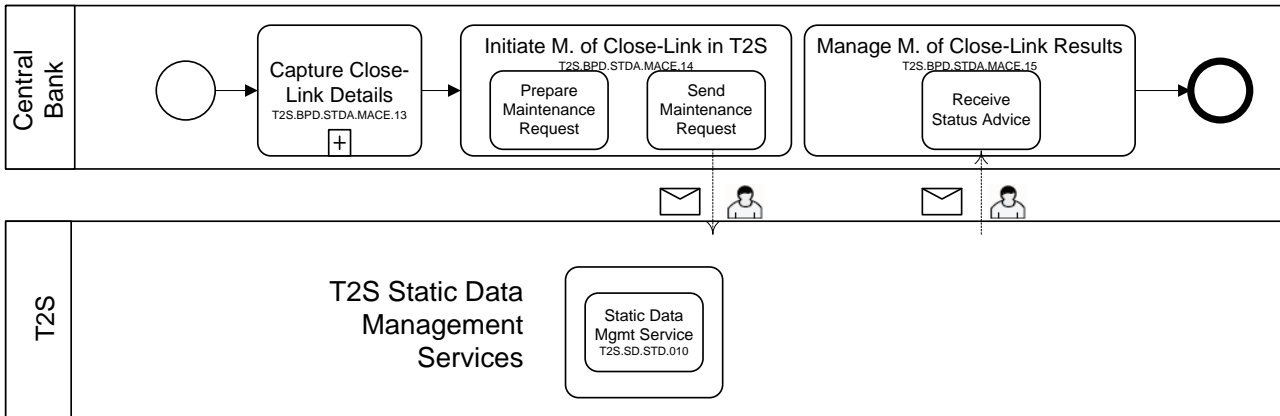

4

5 **7.15.3 BUSINESS PROCESS DESCRIPTION**

6 **7.15.3.1 MAINTENANCE OF AUTO-COLLATERALISATION RULES IN T2S**

7 T2S Actors: Central Bank (Scenario A)/Payment Bank (Scenario B)

8 This process starts when a Central Bank [Payment Bank] intends to maintain (i.e. create/ update/ delete) the
 9 auto-collateralisation rules in T2S for its market, either for itself or for its Payment Bank being a credit
 10 provider. The collateralisation rules includes the collateralisation procedure as “repo” or “pledge” or
 11 “pledge-sub” as allowed by the central bank in its market for the purpose of auto-collateralisation with its
 12 Payment Banks. However for the client-collateralisation, “repo” is the only collateralisation procedure
 13 allowed in T2S.

14 References:

15 GUI BFD: “Collateralisation Eligibility” (Chapter 4.7)

16

1 **7.15.3.1.1 Capture Auto-Collateralisation Rules Details**

Reference ID	T2S.BPD.STDA.MACE.01
---------------------	-----------------------------

2 T2S Actors: Central Bank (Scenario A)/Payment Bank (Scenario B)

3 The Central Bank [Payment Bank] receives the auto-collateralisation related information from other sources
4 in the Central Bank [Payment Bank] or from its Payment Bank(s) prior to setup in T2S.

5 The Central Bank [Payment Bank] validates for the correctness of this information. The Central Bank
6 [Payment Bank] can further enrich the auto-collateralisation related information with any other needed
7 information (e.g. T2S Party identifier) prior to setup in T2S.

8 **7.15.3.1.2 Initiate Maintenance of Auto-Collateralisation Rules in T2S**

Reference ID	T2S.BPD.STDA.MACE.02
---------------------	-----------------------------

9 T2S Actors: Central Bank (Scenario A)/Payment Bank (Scenario B)

10 The Central Bank [Payment Bank] uses the details to create a maintenance instruction for the maintenance of
11 auto-collateralisation rules.

12 References:

13 GUI BFD: T2S.GUI.SDSE.COL.0010, T2S.GUI.SDSE.COL.0020, T2S.GUI.SDSE.COL.0030,
14 T2S.GUI.SDSE.COL.0040, T2S.GUI.SDSE.COL.0050, T2S.GUI.SDSE.COL.0060,
15 T2S.GUI.SDSE.COL.0070

16 **7.15.3.1.2.1 Prepare Maintenance Request**

Reference ID	T2S.BPD.STDA.MACE.02.01
---------------------	--------------------------------

17 The Central Bank [Payment Bank] collects the auto-collateralisation rules maintenance details and prepares
18 the maintenance instruction.

19 *For creation of auto-collateralisation rules*

20 The Central Bank [Payment Bank] creates the auto-collateralisation rules either for itself or for its Payment
21 banks as the credit provider. T2S allows the Central Bank to create these rules intraday.

22 *For amendment of auto-collateralisation rules*

23 The Central Bank [Payment Bank] can amend the auto-collateralisation rules for its market. T2S allows the
24 Central Bank to amend these rules intraday.

25

1 *For deletion of auto-collateralisation rules*

2 The Central Bank [Payment Bank] can perform the logical deletion of the auto-collateralisation rules data.
 3 T2S allows the Central Bank [Payment Bank] to delete these rules intraday.

4 **7.15.3.1.2.2 Enter Maintenance Request**

Reference ID	T2S.BPD.STDA.MACE.02.02
---------------------	--------------------------------

5 The Central Bank [Payment Bank] initiates the maintenance instruction depending on the type of
 6 maintenance action (i.e. create, update or delete) with T2S specific reference data, in T2S GUI.

7 **7.15.3.1.3 T2S Processing**

8 The **Static Data Management Service (T2S.SD.STD.010)** validates the incoming requests entered via the
 9 GUI. The **Static Data Management Service (T2S.SD.STD.010)** executes the creation/update/deletion of
 10 data and shows the acceptance of rejection of the request on the screen.

11 **7.15.3.1.4 Manage Maintenance Results**

Reference ID	T2S.BPD.STDA.MACE.03
---------------------	-----------------------------

12 T2S Actors: Central Bank (Scenario A)/Payment Bank (Scenario B)
 13 The Central Bank [Payment Bank] receives results of the maintenance from T2S.

14 **7.15.3.1.4.1 Receive Status**

Reference ID	T2S.BPD.STDA.MACE.03.01
---------------------	--------------------------------

15 The Central Bank [Payment Bank] can view the results of the processing in the T2S GUI. The Central Bank
 16 [Payment Bank] can subsequently update its internal applications for reasons such as amending the auto-
 17 collateralisation rules or cascade the information to its market participants.

18 **7.15.3.2 MAINTENANCE OF ELIGIBLE COUNTERPARTIES IN T2S**

19 T2S Actors: Central Bank (Scenario A)/Payment Bank (Scenario B)
 20 This process starts when a client of a Central Bank [Payment Bank] needs to use auto-collateralisation or
 21 client-collateralisation facilities in T2S.
 22 References:
 23 GUI BFD: Chapters “Amend T2S Dedicated Cash Account Details”, “Display Securities Account(s) or
 24 Party(ies) Linked to T2S Dedicated Cash Account” or “Limits”

1 **7.15.3.2.1 Capture Eligible Counterparty Details**

Reference ID	T2S.BPD.STDA.MACE.04
---------------------	-----------------------------

2 T2S Actors: Central Bank (Scenario A)/Payment Bank (Scenario B)

3 The Central Bank [Payment Bank] receives the information related to eligible counterparties from other
4 sources in the Central Bank [Payment Bank] or from its Payment Bank(s) prior to setup in T2S.

5 The Central Bank [Payment Bank] validates for the correctness of this information. It can further enrich the
6 information with any other needed information (e.g. T2S Party identifier, Limits) prior to setup in T2S.

7 **7.15.3.2.2 Initiate Maintenance of Eligible Counterparties in T2S**

Reference ID	T2S.BPD.STDA.MACE.05
---------------------	-----------------------------

8 T2S Actors: Central Bank (Scenario A)/Payment Bank (Scenario B)

9 The Central Bank [Payment Bank] uses the details from the data received in the previous step to create a
10 maintenance instruction. This activity relates to a maintenance activity in T2S of the list of parties authorised
11 to use a T2S dedicated cash account, initiated via U2A by a user of a Central Bank [Payment Bank]. Further,
12 the Central Bank [Payment Bank] can setup limits to its authorised clients.

13 References:

14 UDFS: Use Case “Maintain Static Data” (Chapter 2.20)

15 GUI BFD: T2S.GUI.SDSE.DCA.0010, T2S.GUI.SDSE.DCA.0020, T2S.GUI.SDSE.DCA.0030,
16 T2S.GUI.SDSE.DCA.0040, T2S.GUI.SDSE.DCA.0070, T2S.GUI.SDSE.DCA.0080,
17 T2S.GUI.SDSE.LMT.0010, T2S.GUI.SDSE.LMT.0020, T2S.GUI.SDSE.LMT.0030,
18 T2S.GUI.SDSE.LMT.0040, T2S.GUI.SDSE.LMT.0050, T2S.GUI.SDSE.LMT.0060

19 **7.15.3.2.2.1 Prepare Maintenance Request**

Reference ID	T2S.BPD.STDA.MACE.05.01
---------------------	--------------------------------

20 The Central Bank [Payment Bank] collects its list of eligible counterparties maintenance details and prepares
21 the maintenance instruction with “Amendment of T2S dedicated cash account details” for the addition or
22 deletion of eligible counterparties authorized to use a T2S dedicated cash account. T2S allows the owner of
23 T2S dedicated cash account to add or delete the parties that are eligible to use the T2S dedicated cash
24 account for the cash leg settlement of securities settlement instructions.

25 Further, the Central Bank [Payment Bank] collects the details of the limits to be setup for each of its eligible
26 counterparties and prepares the maintenance instruction with “Add/ Amend limits”.

1 **7.15.3.2.2 Enter Maintenance Request**

Reference ID	T2S.BPD.STDA.MACE.05.02
---------------------	--------------------------------

2 The Central Bank [Payment Bank] initiates the maintenance instruction(s) with T2S specific reference data
 3 to maintain the set of eligible counterparties via T2S GUI.

4 **7.15.3.2.3 T2S Processing**

5 The **Static Data Management Service (T2S.SD.STD.010)** validates the incoming requests entered via the
 6 GUI. The **Static Data Management Service (T2S.SD.STD.010)** executes the creation/update/deletion of
 7 data and shows the acceptance of rejection of the request on the screen.

8 **7.15.3.2.4 Manage Maintenance of Eligible Counterparty Results**

Reference ID	T2S.BPD.STDA.MACE.06
---------------------	-----------------------------

9 T2S Actors: Central Bank (Scenario A)/Payment Bank (Scenario B)
 10 The Central Bank [Payment Bank] receives results of the maintenance from T2S.

11 **7.15.3.2.4.1 Receive Status**

Reference ID	T2S.BPD.STDA.MACE.06.01
---------------------	--------------------------------

12 The Central Bank [Payment Bank] views the results of the processing in the T2S GUI. The Central Bank
 13 [Payment Bank] can subsequently update its internal applications for reasons such as amending the list of
 14 eligible counterparties or cascade the information to its market participants.

15 **7.15.3.3 MAINTENANCE OF SECURITIES AUTO-COLLATERALISATION ELIGIBILITY IN**
 16 **T2S**

17 T2S Actors: Central Bank (Scenario A)/Payment Bank (Scenario B)

18 This process starts when a Central Bank intends to maintain (i.e. create/ update/ delete) the list of securities
 19 eligible for auto-collateralisation in a specific currency in T2S for its market. Either it can perform such
 20 maintenance for itself or for its Payment Bank being a credit provider.

21 References:

22 UDFS: Use Case “Maintain Static Data” (Chapter 2.20)

23 GUI BFD: “Collateralisation Eligibility” (Chapter 4.7)

24

1 **7.15.3.3.1 Capture Securities for Auto-collateralisation Details**

Reference ID	T2S.BPD.STDA.MACE.07
---------------------	-----------------------------

2 T2S Actors: Central Bank (Scenario A)/Payment Bank (Scenario B)

3 The Central Bank [Payment Bank] receives information on one or more securities as eligible or ineligible for
 4 auto-collateralisation in a specific currency, from other sources in the Central Bank [Payment Bank] or from
 5 its Payment Bank(s) prior to setup in T2S. The Central Bank [Payment Bank] validates for the correctness of
 6 this information.

7 The Central Bank [Payment Bank] further enriches the list of securities for auto-collateralisation related
 8 information with any other needed information (e.g. T2S Party identifier) prior to setup in T2S.

9 **7.15.3.3.2 Initiate Maintenance of Securities for Auto-collateralisation in T2S**

Reference ID	T2S.BPD.STDA.MACE.08
---------------------	-----------------------------

10 T2S Actors: Central Bank (Scenario A)/Payment Bank (Scenario B)

11 The Central Bank [Payment Bank] initiates the maintenance of the eligible securities for auto-
 12 collateralisation, via U2A or via A2A.

13 References:

14 UDFS: Use Case “Maintain SD” (Chapter 2.20)

15 GUI BFD: T2S.GUI.SDSE.COL.0010, T2S.GUI.SDSE.COL.0020, T2S.GUI.SDSE.COL.0030,
 16 T2S.GUI.SDSE.COL.0040, T2S.GUI.SDSE.COL.0050, T2S.GUI.SDSE.COL.0060,
 17 T2S.GUI.SDSE.COL.0070

18 **7.15.3.3.2.1 Prepare Maintenance Request**

Reference ID	T2S.BPD.STDA.MACE.08.01
---------------------	--------------------------------

19 The Central Bank [Payment Bank] collects the details on securities eligible (or ineligible) for auto-
 20 collateralisation maintenance details and prepares the maintenance instruction.

21 *For creation of new list of securities for auto-collateralisation*

22 The Central Bank [Payment Bank] creates the list of securities eligible for auto-collateralisation via U2A or
 23 A2A, either for itself or for its Payment Banks as the credit provider. T2S allows the Central Bank [Payment
 24 Bank] to create this list intraday.

25

1 *For amendment of the list of securities for auto-collateralisation*

2 The Central Bank [Payment Bank] can amend the list of securities for auto-collateralisation via U2A only.
 3 T2S allows the Central Bank [Payment Bank] to amend this list, intraday.

4 *For deletion of one or more securities from the list of securities for auto-collateralisation rules*

5 The Central Bank [Payment Bank] can perform the logical deletion of the list of securities for auto-
 6 collateralisation via U2A only. T2S allows the Central Bank [Payment Bank] to delete one or more securities
 7 from this list, intraday.

8 **7.15.3.3.2.2 Send Maintenance Request**

Reference ID	T2S.BPD.STDA.MACE.08.02
---------------------	--------------------------------

9 The Central Bank [Payment Bank] formats the maintenance instruction for the creation of eligible securities
 10 reference data with T2S specific securities reference data and sends the maintenance instruction to T2S.

11 For amendment and deletion of data (and alternatively for its creation), the Central Bank [Payment Bank]
 12 enters the request in the T2S GUI.

13 The Central Bank [Payment Bank] sends the following message to T2S:

14 *For creation of eligible securities reference data*

15 **Messages to T2S [T2S.BPD.STDA.MACE.08.02]**

Message Name	ISO Code	To/From T2S	UDFS Chapter
EligibleSecuritiesCreationRequestV01	Reda.025.001.01	To T2S	3.3.6.19

16 **7.15.3.3.3 T2S Processing**

17 The **Static Data Management Service (T2S.SD.STD.010)** validates the incoming requests entered via the
 18 GUI or message (EligibleSecuritiesCreationRequestV01). The **Static Data Management Service**
 19 **(T2S.SD.STD.010)** executes the creation/update/deletion of data and informs about the results via status
 20 advice (CollateralDataStatsAdviceV01) or shows the acceptance of rejection of the request on the screen (for
 21 requests via the GUI).

22 **7.15.3.3.4 Manage Maintenance of Securities for Auto-collateralisation Results**

Reference ID	T2S.BPD.STDA.MACE.09
---------------------	-----------------------------

23 T2S Actors: Central Bank (Scenario A)/Payment Bank (Scenario B)

24 The Central Bank [Payment Bank] receives status advice messages from T2S.

1 **7.15.3.3.4.1 Receive Status Advice**

Reference ID	T2S.BPD.STDA.MACE.09.01
---------------------	--------------------------------

2 The Central Bank [Payment Bank] receives the status advice or views the results of the processing in the T2S
 3 GUI. The Central Bank [Payment Bank] can subsequently update its internal applications for reasons such as
 4 amending the eligible securities maintenance instruction or cascade the information to its market
 5 participants.

6 The Central Bank [Payment Bank] receives the following message from T2S:

7 *For creation of eligible securities reference data*

8 **Table 7-35: Messages from T2S [T2S.BPD.STDA.MACE.09.01]**

Message Name	ISO Code	To/From T2S	Event	UDFS Chapter
CollateralDataSta tsAdviceV01	Reda.028.001.01	From T2S	success, delay or failure of creating the eligible securities reference data	3.3.6.22

9 **7.15.3.4 MAINTENANCE OF SECURITIES PRICES FOR VALUATION PURPOSES IN T2S**

10 T2S Actors: Central Bank (Scenario A)/Payment Bank (Scenario B)

11 This process starts when a Central Bank [Payment Bank] as credit provider intends to provide the collateral
 12 prices (i.e. including haircut) for its list of eligible securities for auto-collateralisation.

13 T2S expects a daily price feed in the respective currency for every financial instrument defined eligible for
 14 auto-collateralisation by the credit provider, for the purposes of securities valuation. If the Central Bank
 15 [Payment Bank] provides credit in multiple currencies, then it has to provide daily price feeds for each of
 16 these currencies.

17 References:

18 UDFS: Use Case “Maintain Static Data” (Chapter 2.20)

19 GUI BFD: Chapter “Securities Valuation” (Chapter 4.3)

20

1 **7.15.3.4.1 Capture Securities Price Details**

Reference ID	T2S.BPD.STDA.MACE.10
---------------------	-----------------------------

2 T2S Actors: Central Bank (Scenario A)/Payment Bank (Scenario B)

3 The Central Bank [Payment Bank] receives securities price information for one or more securities identified
 4 as eligible for auto-collateralisation in a specific currency, from other sources in a Central Bank [Payment
 5 Bank] or from its Payment Bank(s) prior to setup in T2S. The Central Bank [Payment Bank] validates for the
 6 correctness of this information such as haircuts, etc. Further, the Central Bank [Payment Bank] can enrich
 7 the securities price information with any other needed information (e.g. evaluate a dirty price) prior to setup
 8 in T2S.

9 **7.15.3.4.2 Initiate Maintenance of Securities Prices in T2S**

Reference ID	T2S.BPD.STDA.MACE.11
---------------------	-----------------------------

10 T2S Actors: Central Bank (Scenario A)/Payment Bank (Scenario B)

11 The Central Bank [Payment Bank] initiates the maintenance (i.e. create/ update/ delete) of security prices in
 12 T2S, via U2A or A2A. CBs [Payment Banks] send their daily securities valuations in A2A mode via flat
 13 files. They can still use the U2A mode for contingency reasons or maintenance operations concerning a
 14 limited number of records

15 References:

16 UDFS: Use Case “Maintain SD” (Chapter 2.20)

17 GUI BFD: T2S.GUI.SDSE.SVA.0010, T2S.GUI.SDSE.SVA.0020, T2S.GUI.SDSE.SVA.0030,
 18 T2S.GUI.SDSE.SVA.0040, T2S.GUI.SDSE.SVA.0050

19 **7.15.3.4.2.1 Prepare Maintenance Request**

Reference ID	T2S.BPD.STDA.MACE.11.01
---------------------	--------------------------------

20 The Central Bank [Payment Bank] collects the details on securities prices for eligible securities for auto-
 21 collateralisation and prepares the maintenance instruction.

22 *For creation of securities prices reference data*

23 The Central Bank [Payment Bank] creates the list of eligible securities with its prices in the respective
 24 currency as eligible for auto-collateralisation via A2A or U2A. T2S allows Central Bank [Payment Bank] to
 25 create this list intraday and at least once a day. T2S will make use of the latest available prices during
 26 collateral valuation.

1 *For deletion of securities prices reference data*

2 The Central Bank [Payment Bank] can perform the logical deletion of the securities prices for the list of
 3 eligible securities for auto-collateralisation via U2A only. T2S allows the Central Bank [Payment Bank] to
 4 delete securities prices of one or more eligible securities, intraday. T2S will make use of the latest available
 5 prices during collateral valuation.

6 **7.15.3.4.2 Send Maintenance Request**

Reference ID	T2S.BPD.STDA.MACE.11.02
---------------------	--------------------------------

7 The Central Bank [Payment Bank] formats the maintenance instruction for the creation of securities price
 8 reference data with T2S specific securities reference data and sends the maintenance instruction to T2S.

9 For amendment and deletion of data (and alternatively for its creation), the Central Bank [Payment Bank]
 10 enters the request in the T2S GUI.

11 The Central Bank [Payment Bank] sends the following message to T2S:

12 *For creation of securities prices reference data*

13 **Messages to T2S [T2S.BPD.STDA.MACE.11.02]**

Message Name	ISO Code	To/From T2S	UDFS Chapter
Securities Valuation Flat File	NA	To T2S	2.26

14 **7.15.3.4.3 T2S Processing**

15 The **Static Data Management Service (T2S.SD.STD.010)** validates the incoming requests entered via the
 16 GUI or flat file. The **Static Data Management Service (T2S.SD.STD.010)** executes the
 17 creation/update/deletion of data and informs about the results via response file, only mentioning the not
 18 successfully proceeded values, or shows the acceptance or rejection of the request on the screen (for requests
 19 via the GUI).

20 **7.15.3.4.4 Manage Maintenance of Securities Prices Results**

Reference ID	T2S.BPD.STDA.MACE.12
---------------------	-----------------------------

21 T2S Actors: Central Bank (Scenario A)/Payment Bank (Scenario B)

22 The Central Bank [Payment Bank] receives response files from T2S.

23

1 **7.15.3.4.4.1 Receive Status Advice**

Reference ID	T2S.BPD.STDA.MACE.12.01
---------------------	--------------------------------

2 The Central Bank [Payment Bank] receives the response file or views the results of the processing in the T2S
 3 GUI. The Central Bank [Payment Bank] can subsequently update its internal applications for reasons such as
 4 amending the securities prices or related information or cascade the information to its market participants.

5 The Central Bank [Payment Bank] receives the following message from T2S:

6 *For creation of securities prices reference data*

7 **Table 7-36: Messages from T2S [T2S.BPD.STDA.MACE.12.01]**

Message Name	ISO Code	To/From T2S	Event	UDFS Chapter
Response File	NA	From T2S	Generic response and variable number of rows, one for each insertion which triggered an error and was consequently not processed	2.26

8 **7.15.3.5 MAINTENANCE OF CLOSE-LINKS INFORMATION IN T2S**

9 T2S Actors: Central Bank

10 This process starts when a Central Bank as credit provider intends to provide the list of securities not
 11 acceptable as collateral, from a party having a close-link with the issuer of the securities, though the
 12 securities might be eligible for other parties in T2S.

13 References:

14 UDFS: Use Case “Maintain Static Data” (Chapter 2.20)

15 GUI BFD: Chapter “Close Links” (Chapter 4.14)

16

1 **7.15.3.5.1 Capture Close-link Details**

Reference ID	T2S.BPD.STDA.MACE.13
---------------------	-----------------------------

2 T2S Actors: Central Bank

3 The Central Bank receives close links information for one or more securities identified as eligible for auto-
 4 collateralisation, from other sources in a Central Bank prior to setup in T2S. The Central Bank validates for
 5 the correctness of this information.

6 The Central Bank further enriches the close links information with any other needed information (e.g. T2S
 7 Party identifier) prior to setup in T2S.

8 **7.15.3.5.2 Initiate Maintenance of Close-links in T2S**

Reference ID	T2S.BPD.STDA.MACE.14
---------------------	-----------------------------

9 T2S Actors: Central Bank

10 The Central Bank initiates the maintenance of close links.

11 References:

12 UDFS: Use Case “Maintain SD” (Chapter 2.20)

13 GUI BFD: T2S.GUI.SDSE.CLK.0010, T2S.GUI.SDSE.CLK.0020, T2S.GUI.SDSE.CLK.0030,
 14 T2S.GUI.SDSE.CLK.0040, T2S.GUI.SDSE.CLK.0050

15 **7.15.3.5.2.1 Prepare Maintenance Request**

Reference ID	T2S.BPD.STDA.MACE.14.01
---------------------	--------------------------------

16 The Central Bank collects the details on close-links involving eligible securities for auto-collateralisation and
 17 a T2S Party and further prepares the maintenance instruction.

18 *For creation of close-links reference data*

19 The Central Bank creates the list of close-links via U2A or A2A. T2S allows the Central Bank to create this
 20 list intraday.

21 *For amendment of the close-links reference data*

22 The Central Bank can amend the close-links information via U2A only. T2S allows the Central Bank to
 23 amend this list, intraday.

24

1 *For deletion of close-links reference data*

2 The Central Bank can perform the logical deletion of the close-links via U2A only. T2S allows the Central
3 Bank to delete close-links, intraday.

4 **7.15.3.5.2.2 Send Maintenance Request**

Reference ID	T2S.BPD.STDA.MACE.14.01
---------------------	--------------------------------

5 The Central Bank formats the maintenance instruction for creation of close-links reference data with T2S
6 specific securities reference data and sends the maintenance instruction to T2S.

7 For amendment and deletion of data (and alternatively for its creation), the Central Bank enters the request in
8 the T2S GUI.

9 The Central Bank sends the following message to T2S:

10 *For creation of close-links reference data*

11 **Messages to T2S [T2S.BPD.STDA.MACE.14.01]**

Message Name	ISO Code	To/From T2S	UDFS Chapter
CloseLinkCreationRequestV01	Reda.027.001.01	To T2S	3.3.6.21

12 **7.15.3.5.3 T2S Processing**

13 The **Static Data Management Service (T2S.SD.STD.010)** validates the incoming requests entered via the
14 GUI or message (CloseLinkCreationRequestV01). The **Static Data Management Service**
15 **(T2S.SD.STD.010)** executes the creation/update/deletion of data and informs about the results via status
16 advice (CollateralDataStatsAdviceV01) or shows the acceptance of rejection of the request on the screen (for
17 requests via the GUI).

18 **7.15.3.5.4 Manage Maintenance of Close-links Results**

Reference ID	T2S.BPD.STDA.MACE.15
---------------------	-----------------------------

19 T2S Actors: Central Bank

20 The Central Bank receives status advice messages from T2S.

21

1 **7.15.3.5.4.1 Receive Status Ddvice**

Reference ID	T2S.BPD.STDA.MACE.15.01
---------------------	--------------------------------

2 The Central Bank received a status advice or views the results of the processing in the T2S GUI. It can
 3 subsequently update its internal applications for reasons such as amending the close-link maintenance
 4 instruction or cascade the information to its market participants.

5 The Central Bank receives the following message from T2S:

6 *For creation of close-links reference data*

7 **Table 7-37: Messages from T2S [T2S.BPD.STDA.MACE.15.01]**

Message Name	ISO Code	To/From T2S	Event	UDFS Chapter
CollateralDataStats AdviceV01	Reda.028.001.01	From T2S	success, delay or failure of creating the close-links reference data	3.3.6.22

8

1 7.16 MAINTENANCE OF MARKET SPECIFIC ATTRIBUTES 2 [T2S.BPD.STD.MMSA]

3 7.16.1 OVERVIEW

4 This process describes the act of creating, updating and deleting Market Specific Attributes in T2S as
5 accessible to CSDs and Central Banks in the T2S GUI.

6 T2S allows CSDs and Central Banks to define for their market, additional attributes for the Security, Party
7 and Securities account reference data. The Central Banks are only allowed to define Market Specific
8 Attributes for the Party object.

- 9 • The values for these market specific attributes should be defined at the time of the migration of data in
10 T2S.
- 11 • T2S also offers the possibility to create some Market Specific Attributes at any time once a CSD
12 [Central Bank] has migrated its data, in which case the CSD or Central Bank is responsible to migrate
13 the values for the Market Specific Attributes for the Securities, Party and Securities Account which are
14 already defined in T2S.

15 These market specific attributes can then be used for information purposes and/or for validation purposes.
16 Additional validations can be defined by the CSD or Central Bank via the set-up of restrictions in order to be
17 able to “reject” or “hold” an instruction based on a set of rules/parameter values (including its defined market
18 specific attributes) defined in the T2S static data.

19 If a CSD or Central Bank has defined mandatory Market Specific Attributes for a given object, it has to
20 specify a value for it when creating the relevant object in static data. Otherwise the static data creation
21 request will be rejected. For instance the security maintaining CSD needs to provide the Market Specific
22 Attributes(s) it has defined as mandatory when creating the ISIN in T2S.

23 If a CSD or Central Bank wants to modify an existing Market Specific Attributes and change the cardinality
24 from optional to mandatory, it needs to update the relevant static data objects via maintenance requests in
25 order to provide a value for the Market Specific Attributes before submitting the maintenance of the Market
26 Specific Attributes via the GUI.

27 With regards to security Market Specific Attributes, an investor CSD that has created Market Specific
28 Attributes(s) for its own securities should also fill these values for securities for which it creates a Security
29 CSD link (if the Market Specific Attributes is defined as mandatory). Otherwise the Security CSD link
30 creation request will be rejected.

1 If a Market Specific Attributes requires its values to be defined as a fixed list, T2S will check that at the time
 2 the CSD or Central Bank provides the Market Specific Attributes value when creating a static data object
 3 (security, party, securities account), the value is valid with regards to the list of values defined for the
 4 relevant attribute domain.

5 To provide a value of Market Specific Attributes for a given object, the CSD or Central Bank needs to use
 6 the related static data maintenance functions, for instance Security Creation or Maintenance request to
 7 provide the Market Specific Attributes value for a given ISIN.

8 For details, refer to processes “Maintenance of Securities [T2S.BPD.STDA.MSEC]”, “Maintenance of
 9 Securities Account [T2S.BPD.STDA.MSAC]”, “Maintenance of CSD Participant
 10 [T2S.BPD.STDA.MPTY]”, “Maintenance of Payment Bank [T2S.BPD.STDA.MPBK]”.

11 For details on the use of Market Specific Attributes for the set-up of restriction rules, refer to process
 12 “Management of Restrictions [T2S.BPD.STDA.MRES]”.

13 **Trigger:**

14 The CSD or Central Bank identifies the need to create, amend or delete a market specific attribute for
 15 Security, Securities account or Party¹²³ entities in T2S.

16 **Preconditions:**

17 None

18 **T2S Instructing Party:**

19 There are two scenarios for the instruction of T2S:

- 20 • Scenario A: CSD instructs T2S.
- 21 • Scenario B: Central Bank instructs T2S.

22 **7.16.2 BUSINESS PROCESS DIAGRAM**

23 **Figure 7-16: Business Process Diagram [T2S.BPD.STD.MMSA]**

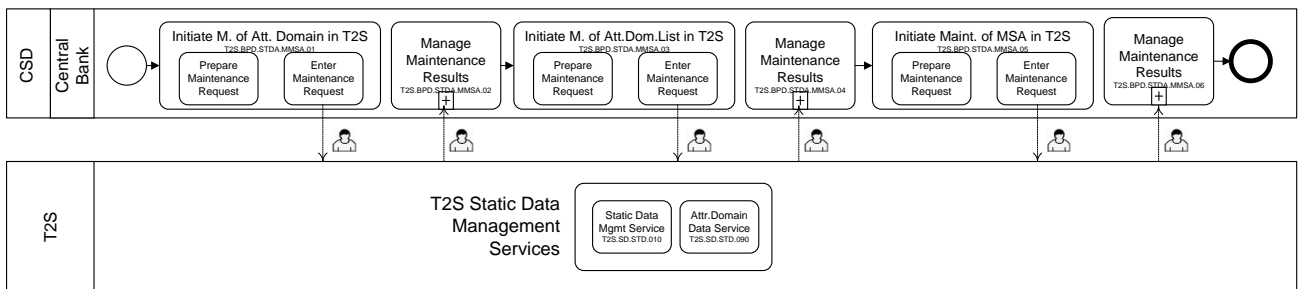

¹²³ Only Party object is available for Central Bank market specific attribute definition

1 **7.16.3 BUSINESS PROCESS DESCRIPTION**

2 This Business Process Description is applicable to Scenario A and B unless otherwise noted. For the purpose
 3 of readability, the actor names in the text refer to Scenario A with the Scenario B actor indicated in square
 4 brackets.

5 **7.16.3.1 MAINTAIN ATTRIBUTE DOMAIN**

6 **7.16.3.1.1 Initiate Maintenance of Attribute Domain in T2S**

Reference ID	T2S.BPD.STD.MMSA.01
--------------	---------------------

7 T2S Actors: CSD (Scenario A)/Central Bank (Scenario B)

8 The CSD [Central Bank] enriches the maintenance request with details required for the static data processing
 9 in T2S and sends the static data maintenance instruction to T2S via GUI and views the result of the
 10 maintenance.

11 References:

12 GUI BFD: T2S.GUI.SDSE.ADN.0010, T2S.GUI.SDSE.ADN.0020, T2S.GUI.SDSE.ADN.0030,
 13 T2S.GUI.SDSE.ADN.0040, T2S.GUI.SDSE.ADN.0050, T2S.GUI.SDSE.ADN.0060

14 **7.16.3.1.1.1 Prepare Maintenance Request**

Reference ID	T2S.BPD.STD.MMSA.01.01
--------------	------------------------

15 The CSD [Central Bank] can create, update or delete an attribute domain. Depending on the required action
 16 it may use the queries in T2S to view existing attribute domain details.

17 *For creation of attribute domain data*

18 For creation of an attribute domain, the CSD [Central Bank] needs to specify the following information:

- 19 • domain name,
- 20 • domain description,
- 21 • format,
- 22 • minimum length,
- 23 • maximum length,
- 24 • case.

25 *For modification of attribute domain data*

26 The CSD [Central Bank] can modify an existing attribute domain it has created.

1 *For deletion of attribute domain data*

2 The CSD [Central Bank] can delete an attribute domain that it has previously defined.

3 **7.16.3.1.1.2 Enter Maintenance Request**

Reference ID	T2S.BPD.STD.MMSA.01.02
--------------	------------------------

4 The CSD [Central Bank] enters the attribute domain maintenance details and submit the request to T2S via
5 the GUI.

6 **7.16.3.1.2 T2S Processing**

7 The **Static Data Management Service (T2S.SD.STD.010)** validates the incoming requests entered via the
8 GUI and shows the acceptance or rejection of the request on the screen. The **Attribute Domain Data**
9 **Service (T2S.SD.STD.090)** triggers the maintenance of attribute domains, their list of valid values and the
10 definition of market specific attributes.

11 **7.16.3.1.3 Manage Maintenance Results**

Reference ID	T2S.BPD.STD.MMSA.02
--------------	---------------------

12 T2S Actors: CSD (Scenario A)/Central Bank (Scenario B)

13 The CSD [Central Bank] views the on-screen message about the execution or rejection of the attribute
14 domain maintenance request.

15 It triggers the relevant processes on the CSD [Central Bank] side based on the result of the maintenance.

16 **7.16.3.2 MAINTAIN ATTRIBUTE DOMAIN LIST OF VALID VALUES**

17 **7.16.3.2.1 Initiate Maintenance of Attribute Domain List in T2S**

Reference ID	T2S.BPD.STD.MMSA.03
--------------	---------------------

18 T2S Actors: CSD (Scenario A)/Central Bank (Scenario B)

19 The CSD [Central Bank] enriches the maintenance request with details required for the static data processing
20 in T2S and sends the static data maintenance instruction to T2S via GUI and receive the result of the
21 maintenance. No messages are available for the maintenance of attribute domain list of valid values in T2S.

22 References:

23 GUI BFD: T2S.GUI.SDSE.ADN.0010, T2S.GUI.SDSE.ADN.0020, T2S.GUI.SDSE.ADN.0030,
24 T2S.GUI.SDSE.ADN.0040, T2S.GUI.SDSE.ADN.0050, T2S.GUI.SDSE.ADN.0060

1 **7.16.3.2.1.1 Prepare Maintenance Request**

Reference ID	T2S.BPD.STD.MMSA.03.01
--------------	------------------------

2 The CSD [Central Bank] can create, update or delete an attribute domain list of valid values. Depending on
 3 the required action it may use the queries in T2S to view existing attribute domain list of values details.

4 It is not necessary to create an attribute domain list of values if the CSD [Central Bank] wishes to create a
 5 Market Specific Attributes for which there is no need of pre-defined list of values. In this case the CSD
 6 [Central Bank] can directly create the Market Specific Attributes after having created the attribute domain.

7 *For creation of list*

8 CSD [Central Bank] can create a list of valid values for a given attribute domain.

9 *For modification of list*

10 CSD [Central Bank] can modify the list of valid values for a given attribute domain.

11 *For deletion of list*

12 CSD [Central Bank] can delete an existing value out of a list for a given attribute domain.

13 **7.16.3.2.1.2 Enter Maintenance Request**

Reference ID	T2S.BPD.STD.MMSA.03.02
--------------	------------------------

14 The CSD [Central Bank] enters the attribute domain list of values maintenance details and submit the request
 15 to T2S via the GUI.

16 **7.16.3.2.2 T2S Processing**

17 The **Static Data Management Service (T2S.SD.STD.010)** validates the incoming requests entered via the
 18 GUI and shows the acceptance or rejection of the request on the screen. The **Attribute Domain Data**
 19 **Service (T2S.SD.STD.090)** triggers the maintenance of attribute domains, their list of valid values and the
 20 definition of market specific attributes.

21 **7.16.3.2.3 Manage Maintenance Results**

Reference ID	T2S.BPD.STD.MMSA.04
--------------	---------------------

22 The CSD [Central Bank] views the on-screen message about the execution or rejection of the attribute
 23 domain list of value maintenance request.

24 It triggers the relevant processes on the CSD [Central Bank] side based on the result of the maintenance.

1 **7.16.3.3 MAINTAIN MARKET SPECIFIC ATTRIBUTE**

2 **7.16.3.3.1 Initiate Maintenance of Market Specific Attribute in T2S**

Reference ID	T2S.BPD.STD.MMSA.05
--------------	---------------------

3 T2S Actors: CSD (Scenario A)/Central Bank (Scenario B)

4 The CSD [Central Bank] enriches the maintenance request with details required for the static data processing
 5 in T2S and sends the static data maintenance instruction to T2S via GUI and receive the result of the
 6 maintenance. No messages are available for the maintenance of Market Specific Attribute in T2S¹²⁴.

7 References:

8 GUI BFD: T2S.GUI.SDSE.MSD.0010, T2S.GUI.SDSE.MSD.0020, T2S.GUI.SDSE.MSD.0030,
 9 T2S.GUI.SDSE.MSD.0040, T2S.GUI.SDSE.MSD.0050, T2S.GUI.SDSE.MSD.0060

10 **7.16.3.3.1.1 Prepare Maintenance Request**

Reference ID	T2S.BPD.STD.MMSA.05.01
--------------	------------------------

11 The CSD [Central Bank] can create, update or delete a Market Specific Attribute. Depending on the required
 12 action it may use the queries in T2S to view existing Market Specific Attribute details.

13 *For creation of attribute data*

14 In the case where the Market Specific Attribute to be created needs to have a set of pre-defined values, it is
 15 necessary to create first an Attribute Domain and in a second step to create the valid list of values for the
 16 Attribute domain. (See two previous processes)

17 In the case where the Market Specific Attribute doesn't require a pre-defined list of values, the CSD [Central
 18 Bank] can directly create the Market Specific Attributes after having defined an attribute domain that will
 19 define the format expected (minimum length, maximum length, case) in a generic.

20 The CSD [Central Bank] needs to specify as well some other types of information such as the static data
 21 object type on which the Market Specific Attributes applies, whether the Market Specific Attributes is
 22 mandatory or optional, whether the Market Specific Attributes value must be unique or not. If a market
 23 specific attribute is defined as unique, T2S will check that the value of the valid list of values for the attribute
 24 domain can only occur once when they are assigned to the relevant static data object.¹²⁵

¹²⁴ However messages are available for the Securities, Party and Securities account maintenance.

¹²⁵ In case of a market specific attribute for security object: if only values 1 and 2 are defined as valid for the attribute domain and that the market-specific attribute is defined as unique, it will not be allowed by T2S that two securities have the market specific attribute value 1 at the same time.

1 *For modification of attribute data*

2 CSD [Central Bank] can modify the Market Specific Attributes details via GUI.

3 *For deletion of attribute data*

4 CSD [Central Bank] can delete an existing Market Specific Attributes via GUI.

5 **7.16.3.3.1.2 Enter Maintenance Request**

Reference ID	T2S.BPD.STD.MMSA.05.02
--------------	------------------------

6 The CSD [Central Bank] enters the Market Specific Attribute maintenance details and submit the request to
7 T2S via the GUI.

8 **7.16.3.3.2 T2S Processing**

9 The **Static Data Management Service (T2S.SD.STD.010)** validates the incoming requests entered via the
10 GUI and shows the acceptance or rejection of the request on the screen. The **Attribute Domain Data**
11 **Service (T2S.SD.STD.090)** triggers the maintenance of attribute domains, their list of valid values and the
12 definition of market specific attributes.

13 **7.16.3.3.3 Manage Maintenance Results**

Reference ID	T2S.BPD.STD.MMSA.06
--------------	---------------------

14 The CSD [Central Bank] views the on-screen message about the execution or rejection of the Market
15 Specific Attribute maintenance request.

16 It triggers the relevant processes on the CSD [Central Bank] side based on the result of the maintenance.

17 **7.17 MAINTENANCE OF SYSTEM USER [T2S.BPD.STDA.MUSE]**

18 **7.17.1 OVERVIEW**

19 This process describes the act of maintaining system user details in T2S. A system user can be an individual
20 or an application that can communicate with T2S using a login name and authorisation credentials. Each
21 system user data in T2S receives individual grants of privileges determining how this system user is allowed
22 to interact with T2S.

23 Administrative system users for CSDs and Central Banks are created by the T2S operator initially. These
24 system users will have sufficient privileges to create the business users for their own CSD/Central Bank as
25 well as administrative and business users for their participants.

26

1 **Trigger:**

2 A CSD, CSD Participant, Central Bank or Payment Bank needs to create or maintain system user in T2S.

3 **Preconditions:**

4 None

5 **T2S Instructing Party:**

6 There are four scenarios for the instruction of T2S:

- 7 • CSD instructs T2S.
- 8 • CSD Participant instructs T2S.
- 9 • Central Bank instructs T2S.
- 10 • Payment Bank instructs T2S.

11 **7.17.2 BUSINESS PROCESS DIAGRAM**

12 **Figure 7-17: Business Process Diagram [T2S.BPD.STDA.MUSE]**

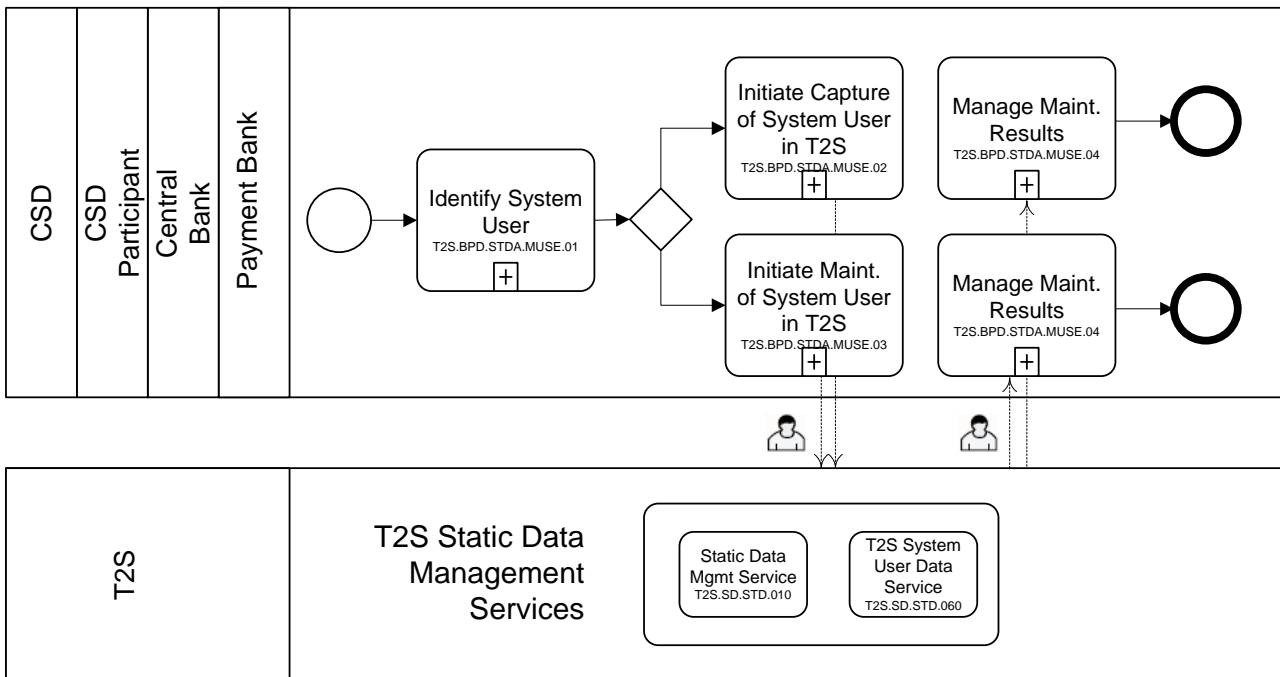

13

14

1 **7.17.3 BUSINESS PROCESS DESCRIPTION**

2 **7.17.3.1 IDENTIFY SYSTEM USER**

Reference ID	T2S.BPD.STDA.MUSE.01
--------------	----------------------

3 T2S Actors: CSD/CSD Participant/Central Bank/Payment Bank

4 The CSD [CSD Participant, Central Bank, Payment Bank] identifies whether a new user has to be created or
 5 an existing user details has to be updated in T2S.

6 **7.17.3.2 INITIATE CAPTURE OF SYSTEM USER IN T2S**

Reference ID	T2S.BPD.STDA.MUSE.02
--------------	----------------------

7 T2S Actors: CSD/CSD Participant/Central Bank/Payment Bank

8 An administrative system user in the CSD [CSD Participant, Central Bank, Payment Bank] captures the
 9 details of the T2S system user to be created in T2S. A creation of new system users is only possible via the
 10 T2S GUI (U2A).

11 References:

12 GUI BFD: T2S.GUI.SDSE.ROL.0090

13 **7.17.3.3 INITIATE MAINTENANCE OF SYSTEM USER IN T2S**

Reference ID	T2S.BPD.STDA.MUSE.03
--------------	----------------------

14 T2S Actors: CSD/CSD Participant/Central Bank/Payment Bank

15 An administrative user of the CSD [CSD Participant, Central Bank, Payment Bank] can query the details of
 16 the system user, as they are stored in T2S, to assess the necessary updates.

17 An administrative user of the CSD [CSD Participant, Central Bank, Payment Bank] performs the necessary
 18 updates by either changing the status of the system user (i.e. for delete, unlock, lock) or updating the system
 19 user's attributes (i.e. for updates, changing privileges).

20 References:

21 GUI BFD: T2S.GUI.SDSE.USR.0010, T2S.GUI.SDSE.USR.0020, T2S.GUI.SDSE.USR.0030,
 22 T2S.GUI.SDSE.USR.0040, T2S.GUI.SDSE.USR.0060

1 **7.17.3.4 T2S PROCESSING**

2 The Static Data Management Service (**T2S.SD.STD.010**) validates the incoming requests entered via the
3 GUI and shows the acceptance or rejection of the request on the screen. The **T2S System User Data Service**
4 (**T2S.SD.STD.060**) triggers the capture or maintenance of the system user in T2S.

5 **7.17.3.5 MANAGE MAINTENANCE RESULTS**

Reference ID	T2S.BPD.STDA.MUSE.04
--------------	----------------------

6 T2S Actors: CSD/CSD Participant/Central Bank/Payment Bank

7 The CSD [CSD Participant, Central Bank, Payment Bank] receives, via GUI, the response messages as a
8 result of the initiated maintenance request or the system user capture request. In case the response is an error,
9 the business actor could correct the details in the GUI screen and initiate the maintenance/capture request
10 again.

11

1 7.18 MANAGEMENT OF LIMITS [T2S.BPD.STDA.MLIM]

2 7.18.1 OVERVIEW

3 This process describes the act of administrating limits in T2S. The Central Bank and its Payment Banks (and
4 any other authorised T2S Actors) needs to manage the below mentioned limits in T2S to control and monitor
5 the usage of its liquidity in T2S by its clients:

- 6 • auto-collateralisation limit,
- 7 • external guarantee limit,
- 8 • client-collateralisation limit,
- 9 • unsecured limit.

10 The need to set or reset such limits is realised for reasons as mentioned below

- 11 • A client of a Central Bank or of a Payment Bank becomes an eligible/ineligible party for auto-
12 collateralisation or client-collateralisation respectively.
- 13 • A client of a Payment Bank has an arrangement with its Payment Bank to have an external guarantee
14 limit and/or an unsecured limit to be used in T2S for the purposes of securities settlement, which needs
15 to be managed by the Payment Bank.
- 16 • An eligible party (i.e. a client of an Central Bank or of a Payment Bank) has changes to its credit
17 worthiness as its credit rating by the rating agencies could have implications to its available limits in
18 T2S.
- 19 • An eligible party has used its available limits in T2S but failed to reimburse its liquidity provider .

20 The privileged T2S Actors can use the below mentioned limit maintenance facilities to set or reset the limits
21 in T2S as per their needs:

- 22 • create limit,
- 23 • update limit,
- 24 • delete limit.

25 These facilities will be available at any time during a settlement day in T2S for all privileged T2S Actors.

26 **Trigger:**

27 This process starts when the Payment Bank/Central Bank intends to set or reset the limits in T2S for its
28 clients.

- 29 • Central Bank(s) receive liquidity usage details from T2S and/or its Payment Banks.

- Payment banks receive liquidity usage details from T2S and/or its clients.

Preconditions:

None

T2S Instructing Party:

There are two scenarios for the instruction of T2S:

- Scenario A: Central Bank instructs T2S (for its own or on behalf of the Payment Bank).
- Scenario B: Payment Bank instructs T2S.

7.18.2 BUSINESS PROCESS DIAGRAM

Figure 7-18: Business Process Diagram [T2S.BPD.STDA.MLIM]

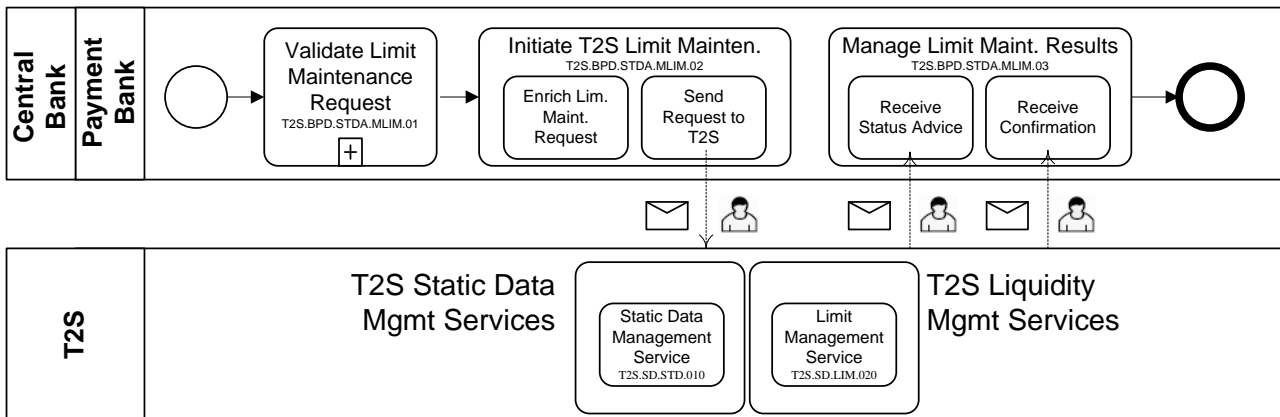

10

7.18.3 BUSINESS PROCESS DESCRIPTION

This Business Process Description is applicable to Scenario A and B unless otherwise noted. For the purpose of readability, the actor names in the text refer to Scenario A with the Scenario B actor indicated in square brackets.

7.18.3.1 VALIDATE LIMIT MAINTENANCE REQUEST

Reference ID	T2S.BPD.STDA.MLIM.01
--------------	----------------------

T2S Actors: Central Bank (Scenario A)/Payment Bank (Scenario B)

The Central Bank [Payment Bank] checks all the details related to limit maintenance against the reference data (maintained by the Central Bank or Payment Bank) and may perform additional checks/validations.

19

1 **7.18.3.2 INITIATE T2S LIMIT MAINTENANCE**

Reference ID	T2S.BPD.STDA.MLIM.02
--------------	----------------------

2 T2S Actors: Central Bank (Scenario A)/Payment Bank (Scenario B)

3 The Central Bank [Payment Bank] enriches the limit maintenance request with details required for setting or
 4 resetting one or more limits in T2S and sends the limit maintenance request to T2S via a message (or) place
 5 the limit maintenance request via the T2S GUI.

6 References:

7 UDFS: Use Case “Maintain Static data” (Chapter 2.20)

8 GUI BFD: See section 4.13 to query and maintain limits in T2S via the T2S GUI

9 **7.18.3.2.1 Enrich Limit Maintenance Request**

Reference ID	T2S.BPD.STDA.MLIM.02.01
--------------	-------------------------

10 The Central Bank [Payment Bank] enriches the limit maintenance request with specific information such as
 11 account numbers, currency, limit amounts, type of limit etc.

12 The Central Bank [Payment Bank] might want to use the query facilities in the RTGS system or T2S to get
 13 the necessary information.

14 **7.18.3.2.2 Send Request to T2S**

Reference ID	T2S.BPD.STDA.MLIM.02.02
--------------	-------------------------

15 The Central Bank [Payment Bank] converts the limit maintenance request into the required message format
 16 and transmits it to T2S as a message (or) capture the limit maintenance request via the T2S GUI. The
 17 processing of the limit maintenance request in T2S depends on the values specified in the request.

18 The Central Bank [Payment Bank] sends the following message to T2S:

19 **Table 7-38: Messages to T2S [T2S.BPD.STDA.MLIM.02.02]**

Message Name	ISO Code	To/From T2S	UDFS Chapter
ModifyLimit	camt.011.001.05	To T2S	3.3.3.7
DeleteLimit	camt.012.001.05	To T2S	3.3.3.8

1 **7.18.3.3 T2S PROCESSING**

2 The **Static Data Management Service (T2S.SD.STD.010)** validates the incoming request (ModifyLimit or
 3 DeleteLimit). The **Limit Management Service (T2S.SD.LIM.020)** performs the update or deletion of limit
 4 data in T2S and informs about the results (Receipt).

5 **7.18.3.4 MANAGE LIMIT MAINTENANCE RESULTS**

Reference ID	T2S.BPD.STDA.MLIM.03
--------------	----------------------

6 T2S Actors: Central Bank (Scenario A)/Payment Bank (Scenario B)

7 The Central Bank [Payment Bank] receives the limit maintenance related messages, as responses from T2S
 8 and initiates related internal processes, for a limit maintenance request sent to T2S via a message.

9 When the Central Bank [Payment Bank] places a limit maintenance request via the T2S GUI, the flow of
 10 status advices and confirmations as messages to the Central Bank or Payment Bank does not apply. The
 11 results of the validation/processing are available in the T2S GUI.

12 References:

13 UDFS: Use Case “Maintain Static data” (Chapter 2.20)

14 GUI BFD: See section 4.13 to query and maintain limits in T2S via the T2S GUI

15 **7.18.3.4.1 Receive Status Advice**

Reference ID	T2S.BPD.STDA.MLIM.03.01
--------------	-------------------------

16 The Central Bank [Payment Bank] receives status advice messages for every change of status code to the
 17 limit maintenance request in T2S as a result of the validation/processing of the static data maintenance
 18 request.

19 If T2S has been instructed via the T2S GUI the status is shown on the screen.

20 Following the message reception, other internal activities might be conducted such as:

- 21 • aligning the status of the limit maintenance request in the Central Bank’s or Payment bank’s systems
 22 with the status in T2S,
- 23 • triggering notification to their relevant clients.

24

1 The Central Bank [Payment Bank] receives the following message from T2S:

2 **Table 7-39: Messages from T2S [T2S.BPD.STDA.MLIM.03.01]**

Message Name	ISO Code	To/From T2S	Event	UDFS Chapter
Receipt	camt.025.001.03	From T2S	T2S sends a “rejection” (or) “queued” status of an limit maintenance request	3.3.3.12

3 **7.18.3.4.2 Receive Confirmations**

Reference ID	T2S.BPD.STDA.MLIM.03.02
--------------	-------------------------

4 The Central Bank [Payment Bank] receives and validates the confirmations of the limit maintenance request,
 5 sent by T2S to the Central Bank.

6 Following the message reception, other internal activities might be conducted such as:

- 7 • aligning the status of the limit maintenance request in the Central Bank’s or Payment Bank’s books with
- 8 the status in T2S,
- 9 • triggering notification to their relevant clients.

10 The Central Bank [Payment Bank] receives the following message from T2S:

11 **Table 7-40: Messages from T2S [T2S.BPD.STDA.MLIM.03.02]**

Message Name	ISO Code	To/From T2S	Event	UDFS Chapter
Receipt	camt.025.001.03	From T2S	T2S sends “completed” status of an limit maintenance request	3.3.3.12

1 8. STATIC DATA RESTRICTION PROCESSES

2 8.1 (UN)BLOCKING OF SECURITIES [T2S.BPD.STDA.BSEC]

3 8.1.1 OVERVIEW

4 This process describes the act of blocking and unblocking a security in T2S. CSDs in T2S (i.e. Investor
5 CSDs and Issuer CSDs) may need to block the securities for specific purposes. This might be

- 6 • to prevent processing of settlement instructions (trades, Repo, lending and borrowing, reimbursements,
7 etc), or
- 8 • to prevent processing for other purposes such as corporate action, completion of issuance activities,
9 redemptions, securities conversion, annual general meetings, etc.

10 Such a blocking of securities is applicable only to the sphere of responsibility of the CSD setting the
11 blocking (without creating an impact to other participating CSDs in T2S).

12 The securities can also be blocked when the securities are being created. For details on the creation of
13 securities, refer to process “Maintenance of Securities [T2S.BPD.STDA.MSEC]”.

14 CSDs in T2S would normally need to unblock a previously blocked security (i.e. ISIN) to restore normal
15 processing of settlement instructions such as trades, Repo, lending and borrowing, reimbursements, etc
16 and/or settlement restrictions such as intra-position movements. CSDs would need to restore such normal
17 processing, when the need for blocking of that security (i.e. ISIN) expires (e.g. completion of processing of a
18 corporate action, etc).

19 **Trigger:**

- 20 • Blocking: Business reason to block securities are identified by the CSD
- 21 • Unblocking: Business reason to block securities is no longer valid

22 **Preconditions**

23 The restriction types related to blocking of securities are setup in T2S by the relevant CSD (or the T2S
24 Operator).

25 **T2S Instructing Party:**

26 CSD

1 **8.1.2 BUSINESS PROCESS DIAGRAM**

2 **Figure 8-1: Business Process Diagram [T2S.BPD.STDA.BSEC]**

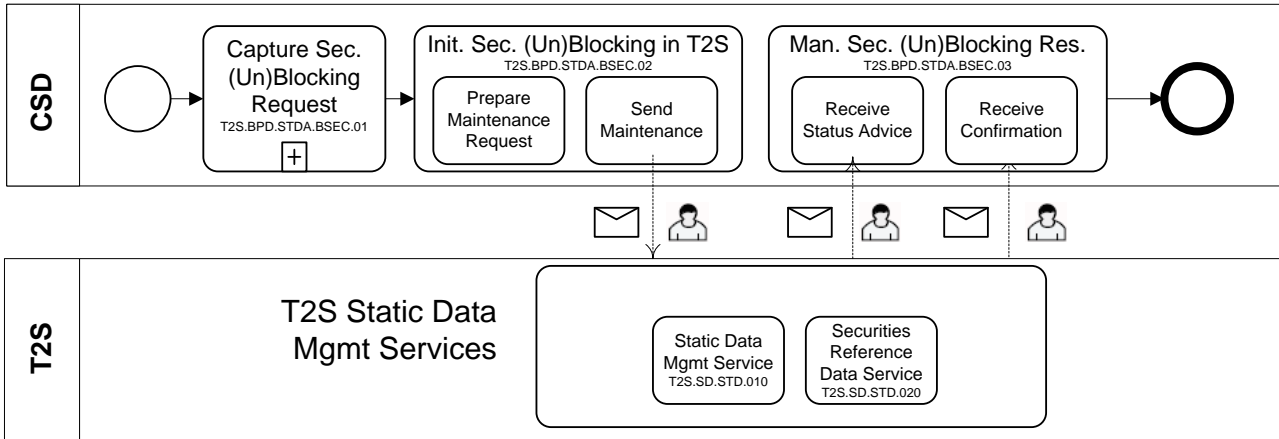

4 **8.1.3 BUSINESS PROCESS DESCRIPTION**

5 **8.1.3.1 CAPTURE SECURITY (UN)BLOCKING REQUEST**

Reference ID	T2S.BPD.STDA.BSEC.01
--------------	----------------------

6 T2S Actors: CSD

7 The CSD checks all the details related to (un)blocking of securities against the reference data (maintained by
8 the CSD) and may perform additional checks/validations.

9 For the unblocking of securities, these checks can include the validation of the “valid till” of the blocking
10 request originally placed in T2S, as the “valid till” may need to be updated [if not specified (or) was
11 incorrectly specified, when the security (i.e. ISIN) was originally blocked in T2S] or may not need to be
12 updated.

13 **8.1.3.2 INITIATE SECURITY (UN)BLOCKING IN T2S**

Reference ID	T2S.BPD.STDA.BSEC.02
--------------	----------------------

14 T2S Actors: CSD

15 The CSD enriches the blocking of securities request with details required in T2S and sends the blocking of
16 securities request to T2S using an A2A message or by placing the blocking request in T2S using the T2S
17 GUI (U2A).

18 References:

19 UDFS: Use Case “Restrict Static data” (Chapter 2.21)

1 GUI BFD: See section 4.10 to query and maintain “Intraday Restrictions” in T2S via the T2S GUI

2 **8.1.3.2.1 Prepare Maintenance Request**

Reference ID	T2S.BPD.STDA.BSEC.02.01
--------------	-------------------------

3 *For blocking of securities*

4 The CSD enriches the blocking of securities request with specific information such as:

- 5 • the security as ISIN,
- 6 • restriction type in T2S for blocking of securities,
- 7 • validity period of the blocking with valid from and valid till timestamps. (For blocking, the request in
8 T2S could be place with valid from timestamp only). In the case where the CSD wants to immediately
9 block the security, a specific timestamp has to be input in the maintenance instruction.

10 The CSD may want to use the query facilities in the CSD system or T2S to get the necessary information.

11 *For unblocking of securities*

12 The unblocking request takes the form of either updating the value of field “valid till” of an existing blocking
13 or deleting the blocking. T2S will add or update such a value to define the time of expiry of the blocking
14 request of the security (i.e. ISIN), after successful processing of the unblocking request. In case the CSD
15 wants immediate removal of the restriction, a specific timestamp has to be input.

16 **8.1.3.2.2 Send Maintenance Request**

Reference ID	T2S.BPD.STDA.BSEC.02.02
--------------	-------------------------

17 The CSD converts the (un)blocking of securities request into the required message format and transmits it to
18 T2S as a message (or) capture the (un)blocking of securities request via the T2S GUI.

19 **Table 8-1: Messages to T2S [T2S.BPD.STDA.BSEC.02.02]**

Message Name	ISO Code	To/From T2S	UDFS Chapter
SecuritiesMaintenanceRequest	reda.007.001.01	To T2S	3.3.6.2

20 **8.1.3.3 T2S PROCESSING**

21 The **Static Data Management Service (T2S.SD.STD.010)** validates the incoming request
22 (SecuritiesMaintenanceRequest). The **Securities Reference Data Service (T2S.SD.STD.020)** triggers the
23 blocking of the security and informs about the processing result (SecuritiesMaintenanceStatusAdvice).

1 **8.1.3.4 MANAGE SECURITIES (UN)BLOCKING RESULTS**

Reference ID	T2S.BPD.STDA.BSEC.03
--------------	----------------------

2 T2S Actors: CSD

3 The CSD receives the blocking of securities maintenance related messages, as responses from T2S and
 4 initiates related internal processes, for a “blocking of securities” maintenance request sent to T2S via a
 5 message.

6 When the CSD places a “blocking of securities” maintenance request via the T2S GUI the results of the
 7 validation and processing status of the blocking request will be shown in T2S GUI. The results of the
 8 processed blocking request will be communicated via A2A.

9 References:

10 UDFS: Use Case “Restrict Static data” (Chapter 2.21)

11 GUI BFD: See section 4.10 to query and maintain “Intraday Restrictions” in T2S via the T2S GUI

12 **8.1.3.4.1 Receive Status Advice**

Reference ID	T2S.BPD.STDA.BSEC.03.01
--------------	-------------------------

13 This activity receives status advice messages for every change of status code to the “blocking of securities”
 14 maintenance request in T2S for the results of the validation/processing of the static data maintenance request.

15 Subsequent to receiving such messages triggers other internal activities as mentioned below

- 16 • aligning the status of the “blocking of securities” or “unblocking of securities” maintenance request in
 17 the CSD’s systems with the status in T2S,
- 18 • triggering notification to their relevant clients.

19 The CSD receives the following message from T2S:

20 **Table 8-2: Messages from T2S [T2S.BPD.STDA.BSEC.03.01]**

Message Name	ISO Code	To/From T2S	Event	UDFS Chapter
SecuritiesMaintenanceStatusAdvice	reda.029.001.01	From T2S	T2S “Rejects” or “Queues” the “blocking of securities” or “unblocking of securities” maintenance request	3.3.6.23

1 **8.1.3.4.2 Receive Confirmation**

Reference ID	T2S.BPD.STDA.BSEC.03.02
--------------	-------------------------

2 The CSD receives and validates the confirmation of the processing of “blocking of securities” or
 3 “unblocking of securities” maintenance request, sent by T2S to the CSD.

4 Subsequent to receiving such messages triggers other internal activities as mentioned below:

- 5 • aligning the status of the “blocking of securities” or “unblocking of securities” maintenance request in
 6 the CSD’s books with the status in T2S,
- 7 • triggering notification to their relevant clients.

8 The CSD receives the following message from T2S:

9 **Table 8-3: Messages from T2S [T2S.BPD.STDA.BSEC.03.02]**

Message Name	ISO Code	To/From T2S	Event	UDFS Chapter
SecuritiesMaintenanceStatusAdvice	reda.029.001.01	From T2S	T2S “completes” the “blocking of securities” or ”unblocking of securities” maintenance request	3.3.6.23

10

1 **8.2 (UN)BLOCKING OF SECURITIES ACCOUNT [T2S.BPD.STDA.BSAC]**

2 **8.2.1 OVERVIEW**

3 This process describes the act of blocking and unblocking a securities account in T2S. A CSD or CSD
4 Participant in T2S may need to block the securities account to prevent processing of settlement instructions
5 on the securities account. As a result, T2S will not consider the settlement instructions on the blocked
6 securities accounts for settlement purpose.

7 This facility will be available at any time during a settlement day in T2S. This procedure takes place by
8 putting a restriction on the static data object “securities account”.

9 CSDs in T2S would normally need to unblock a previously blocked securities account to restore normal
10 processing of relevant settlement instructions (such as trades, Repo, lending and borrowing, reimbursements,
11 etc) and/or settlement restrictions such as intra-position movements. CSDs would need to restore such
12 normal processing, when the need for blocking of a securities account is no longer valid.

13 **Trigger:**

- 14 • Blocking: A business reason to a block securities account is identified
- 15 • Unblocking: Business reason to block securities account is no longer valid

16 **Preconditions**

17 The restriction types related to blocking of securities account are setup in T2S by the relevant CSD (or the
18 T2S Operator).

19 **T2S Instructing Party:**

20 CSD

1 **8.2.2 BUSINESS PROCESS DIAGRAM**

2 **Figure 8-2: Business Process Diagram [T2S.BPD.STDA.BSAC]**

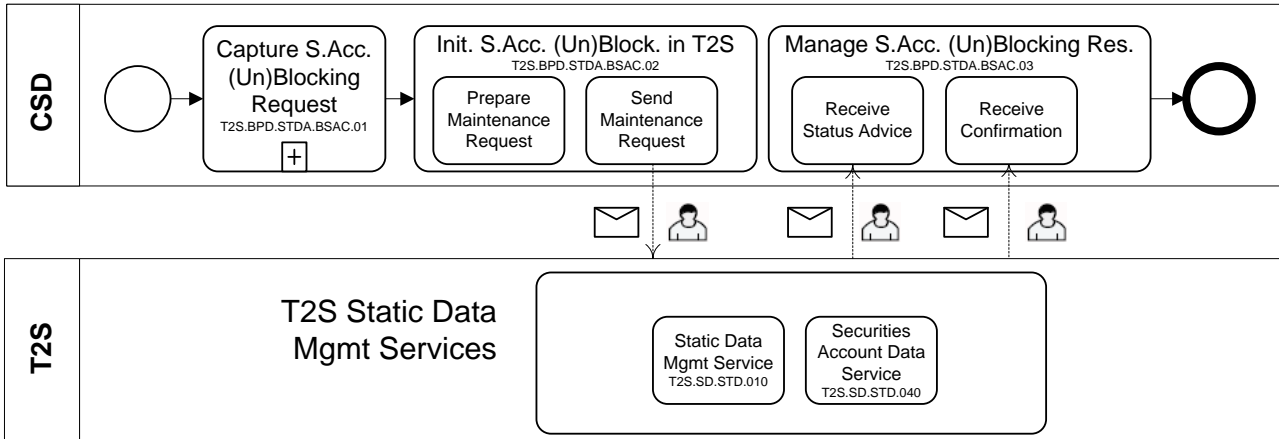

3

4 **8.2.3 BUSINESS PROCESS DESCRIPTION**

5 **8.2.3.1 CAPTURE SECURITIES ACCOUNT (UN)BLOCKING REQUEST**

Reference ID	T2S.BPD.STDA.BSAC.01
--------------	----------------------

6 T2S Actors: CSD

7 The CSD checks all the details related to (un)blocking of securities account against the reference data
8 (maintained by the CSD) and may perform additional checks and validations.

9 For the unblocking of securities position, these checks can include the validation of the “valid till” of the
10 blocking request originally placed in T2S, as the “valid till” may need to be updated [if not specified (or) was
11 incorrectly specified, when the securities account was originally blocked in T2S] or may not need to be
12 updated.

13 **8.2.3.2 INITIATE SECURITIES ACCOUNT (UN)BLOCKING IN T2S**

Reference ID	T2S.BPD.STDA.BSAC.02
--------------	----------------------

14 T2S Actors: CSD

15 The CSD enriches the (un)blocking of securities account request with details required in T2S and sends the
16 blocking of securities account request to T2S using an A2A message or by placing the (un)blocking request
17 in T2S using the T2S GUI (U2A).

18 References:

19 UDFS: Use Case “Restrict Static data” (Chapter 2.21) with the maintenance request as
20 “SecuritiesAccountModificationRequest”

1 GUI BFD: Section 4.10 to query and maintain “Intraday Restrictions” in T2S via the T2S GUI

2 **8.2.3.2.1 Prepare Maintenance Request**

Reference ID	T2S.BPD.STDA.BSAC.02.01
--------------	-------------------------

3 *For blocking of securities position*

4 The CSD enriches the blocking of securities account request with specific information such as

- 5 • securities account number in T2S,
- 6 • restriction type in T2S for blocking of securities account,
- 7 • validity period of the blocking with valid from and valid till timestamps. For blocking, the request in
- 8 T2S could be place with valid from timestamp only.

9 The CSD might want to use the query facilities in the CSD system or T2S to get the necessary information.

10 In case the CSD wants to immediately block the securities account, a specific timestamp has to be used.

11 *For unblocking of securities position*

12 The unblocking request takes the form of updating the value of field “valid till” of an existing blocking. T2S
 13 will update such a value to define the time of expiry of the blocking request of the securities account, after
 14 successful processing of the unblocking request.

15 In case the CSD wants to immediately unblock the securities account, a specific timestamp has to be used.

16 **8.2.3.2.2 Send Maintenance Request**

Reference ID	T2S.BPD.STDA.BSAC.02.02
--------------	-------------------------

17 The CSD converts the (un)blocking of securities account request into the required message format and
 18 transmits it to T2S as an A2A message or by capturing the blocking of securities account request via the T2S
 19 GUI (U2A).

20 The CSD sends the following message to T2S:

21 **Table 8-4: Messages to T2S [T2S.BPD.STDA.BSAC.02.02]**

Message Name	ISO Code	To/From T2S	UDFS Chapter
SecuritiesAccountModificationRequest	reda.023.001.01	To T2S	3.3.6.17

1 **8.2.3.3 T2S PROCESSING**

2 The **Static Data Management Service (T2S.SD.STD.010)** validates the incoming request
 3 (SecuritiesAccountModificationRequest). The **Securities Account Data Service (T2S.SD.STD.040)** triggers
 4 the (un)blocking of the securities account and informs about the processing result
 5 (SecuritiesAccountStatusAdvice).

6 **8.2.3.4 MANAGE SECURITIES ACCOUNT (UN)BLOCKING RESULTS**

Reference ID	T2S.BPD.STDA.BSAC.03
--------------	----------------------

7 T2S Actors: CSD

8 The CSD receives the (un)blocking of securities account related messages, as responses from T2S and
 9 initiates related internal processes.

10 When the CSD places a (un)blocking of securities account request via the T2S GUI, the results of the
 11 validation and processing status of the (un)blocking request will be shown in T2S GUI. The results of the
 12 processed blocking request will be communicated via A2A.

13 References:

14 UDFS: Use Case “Restrict Static data” (Chapter 2.21) with the maintenance request as
 15 “SecuritiesAccountModificationRequest”

16 GUI BFD: Section 4.10 to query and maintain “Intraday Restrictions” in T2S via the T2S GUI

17 **8.2.3.4.1 Receive Status Advice**

Reference ID	T2S.BPD.STDA.BSAC.03.01
--------------	-------------------------

18 The CSD receives status advice messages for every change of status code to the (un)blocking of securities
 19 account request in T2S for the results of the validation and processing of the static data maintenance request.

20 Subsequent to receiving such messages triggers other internal activities as mentioned below

- 21 • aligning the status of the (un)blocking of securities account request in the CSD’s systems with the status
 22 in T2S,
- 23 • triggering notification to their relevant clients.

24

1 The CSD receives the following message from T2S:

2 **Table 8-5: Messages from T2S [T2S.BPD.STDA.BSAC.03.01]**

Message Name	ISO Code	To/From T2S	Event	UDFS Chapter
SecuritiesAccountStatusAdvice	reda.020.001.01	From T2S	T2S “rejects” or “queues” the “blocking of securities account” or “unblocking of securities” request	3.3.6.14

3

1 **8.2.3.4.2 Receive Confirmation**

Reference ID	T2S.BPD.STDA.BSAC.03.02
--------------	-------------------------

2 The CSD receives and validates the confirmation of the processing of (un)blocking of securities account
 3 request, sent by T2S to the CSD.

4 Subsequent to receiving such messages triggers other internal activities as mentioned below:

- 5 • aligning the status of the (un)blocking of securities account request in the CSD’s books with the status in
 6 T2S,
- 7 • triggering notification to their relevant clients.

8 The CSD receives the following message from T2S:

9 **Table 8-6: Messages from T2S [T2S.BPD.STDA.BSAC.03.02]**

Message Name	ISO Code	To/From T2S	Event	UDFS Chapter
SecuritiesAccountSt atusAdvice	reda.020.001.01	From T2S	T2S successfully “completes” the “blocking of securities account” or “unblocking of securities account” request	3.3.6.14

10

1 **8.3 (UN)BLOCKING OF PARTY [T2S.BPD.SETT.BPRT]**

2 **8.3.1 OVERVIEW**

3 This process describes the act of blocking and unblocking one or several parties in T2S. CSDs and Central
4 Banks in T2S may need to block T2S parties for specific purposes. This might be because

- 5 • CSD wants to prevent settlement of settlement instructions from a specific or all of its participants in
6 T2S. Blocking of CSD Participant automatically blocks all of its own securities accounts from
7 settlement. Blocking of a CSD automatically blocks all of its own securities accounts and securities
8 accounts of all of its participants from settlement (CSDs can only be blocked by T2S operator)
- 9 • Central Bank wants to prevent cash leg settlement processing of instructions (settlement instruction/
10 liquidity transfer) for any of its Payment Banks in T2S. Blocking of a Payment Bank automatically
11 blocks all of its own DCAs from settlement. Blocking of a Central Bank automatically blocks all of its
12 own DCAs, DCAs of all of its Payment Banks from settlement (NCBs can only be blocked by T2S
13 Operator).

14 A party can also be blocked during its creation in T2S. For details on the creation of a party, refer to process
15 “Maintenance of CSD Participant [T2S.BPD.STDA.MPTY]”.

16 CSDs/ Central Banks initiate unblocking of party in T2S when the need for blocking of that party is no more
17 (e.g. Bankruptcy of a participant, etc.). The CSD/ Central Bank cannot initiate unblocking of itself, this
18 needs to be done by the T2S Operator.

19 Alternatively, in case a “valid till” timestamp is specified by CSD or Central Bank in the initial “blocking of
20 party” request to T2S, T2S unblocks the party on reaching the “valid till” timestamp.

21 **Trigger:**

- 22 • Blocking: Business reason to block party is identified by the CSD or Central Bank.
- 23 • Unblocking: Business reason to block party is no longer valid.

24 **Preconditions:**

25 The restriction types related to blocking of party are setup in T2S by the relevant CSD or Central Bank (or
26 the T2S Operator)

27 **T2S Instructing Party:**

28 There are two scenarios for the instruction of T2S.

- 29 • Scenario A: CSD instructs T2S
- 30 • Scenario B: Central Bank instructs T2S

1 **8.3.2 BUSINESS PROCESS DIAGRAM**

2 **Figure 8-3: Business Process Diagram [T2S.BPD.STDA.BPTY]**

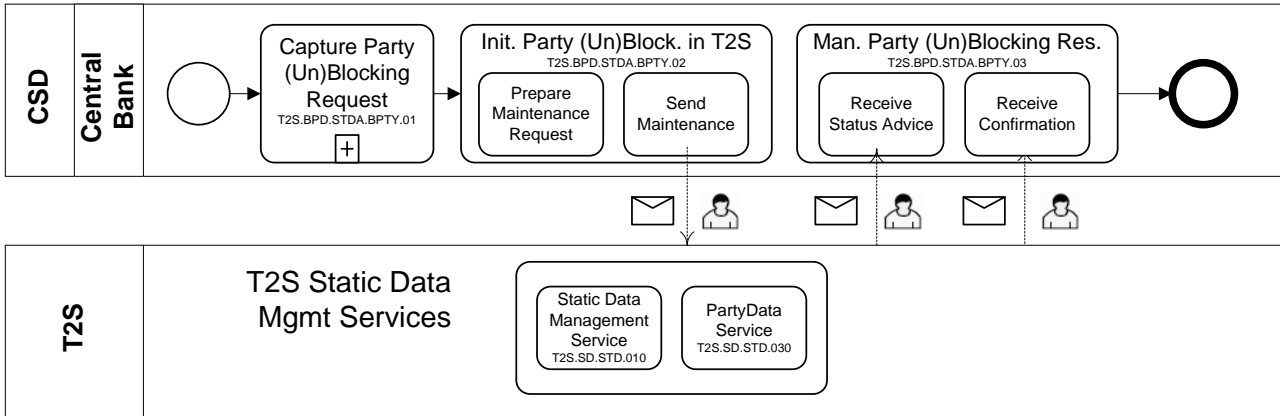

3

4 **8.3.3 BUSINESS PROCESS DESCRIPTION**

5 **8.3.3.1 CAPTURE PARTY (UN)BLOCKING REQUESTS**

Reference ID	T2S.BPD.STDA.BPTY.01
--------------	----------------------

6 T2S Actors: CSD (Scenario A)/Central Bank (Scenario B)

7 The CSD [Central Bank] checks all the details related to (un)blocking of party against the reference data
 8 (maintained by the CSD [Central Bank]) and may perform additional checks/ validations.

9 **8.3.3.2 INITIATE PARTY (UN)BLOCKING IN T2S**

Reference ID	T2S.BPD.STDA.BPTY.02
--------------	----------------------

10 T2S Actors: CSD (Scenario A)/Central Bank (Scenario B)

11 The CSD [Central Bank] enriches the blocking of party request with details required in T2S. The CSD
 12 [Central Bank] initiates blocking of party by sending the blocking request to T2S using an A2A message or
 13 by placing the blocking request in T2S using the T2S GUI (U2A).

14 References:

15 UDFS: Use Case “Restrict Static data” (Chapter 2.21)

16 GUI BFD: T2S.GUI.SDSE.RES.0010, T2S.GUI.SDSE.RES.0020, T2S.GUI.SDSE.RES.0030,
 17 T2S.GUI.SDSE.RES.0040

18

1 **8.3.3.2.1 Prepare Maintenance Request**

Reference ID	T2S.BPD.STDA.BPTY.02.01
--------------	-------------------------

2 *For blocking of party*

3 The CSD [Central Bank] enriches the blocking of party request with specific information such as

- 4 • the BIC of the party to be blocked by which it is identified in T2S,
- 5 • restriction type in T2S for blocking of parties,
- 6 • validity period of the blocking with valid from and valid till timestamps. (For blocking, the request in
- 7 T2S could be place with valid from timestamp only).

8 The CSD [Central Bank] may want to use the query facilities in their system or T2S to get the necessary

9 information.

10 In case the CSD[Central Bank] wants to immediately block a party, a specific timestamp has to be used.

11 *For unblocking of party*

12 The CSD [Central Bank] can achieve unblocking of party in T2S in two ways.

- 13 • By deleting the blocking restriction on the party in T2S. In this case the party will be unblocked by T2S
- 14 immediately.

15 By updating the “valid till” timestamp in the previously placed “blocking of party” request. In this case the

16 party will be unblocked by T2S on reaching the “valid till” timestamp. In case the CSD[Central Bank] wants

17 to immediately unblock a party, a specific timestamp has to be used.

18 **8.3.3.2.2 Send Maintenance Request**

Reference ID	T2S.BPD.STDA.BPTY.02.02
--------------	-------------------------

19 The CSD [Central Bank] converts the blocking of party request enriched with specific information to the

20 format specified by T2S and transmits it to the T2S platform as a message (or) capture the blocking of party

21 request via the T2S GUI.

22 The CSD [Central Bank] sends the following message to T2S:

23 **Table 8-7: Messages to and from T2S [T2S.BPD.STDA.BPTY.02.02]**

Message Name	ISO Code	To/From T2S	UDFS Chapter
PartyModificationRequestV01	reda.022.001.01	To T2S	3.3.6.16

1 **8.3.3.3 T2S PROCESSING**

2 The **Static Data Management Service (T2S.SD.STD.010)** validates the incoming request
 3 (PartyModificationRequestV01). The **T2S Party Data Service (T2S.SD.STD.030)** triggers the (un)blocking
 4 of the party and informs about the processing result (PartyStatusAdviceV01).

5 **8.3.3.4 MANAGE PARTY (UN)BLOCKING RESULTS**

Reference ID	T2S.BPD.STDA.BPTY.03
--------------	----------------------

6 T2S Actors: CSD (Scenario A)/Central Bank (Scenario B)

7 Subsequent to the CSD [Central Bank]’s request to T2S for (un)blocking of party the CSD [Central Bank]
 8 receives messages from T2S as responses. The CSD [Central Bank] could then initiate the related internal
 9 processes based on these responses.

10 When the CSD [Central Bank] places a (un)blocking of party modification request via the T2S GUI the
 11 results of the validation and processing status of the (un)blocking request will be shown in T2S GUI. The
 12 results of the processed blocking request will be communicated via A2A.

13 References:

14 UDFS: Use Case “Restrict Static data” (Chapter 2.21)

15 GUI BFD: T2S.GUI.SDSE.RES.0010, T2S.GUI.SDSE.RES.0020, T2S.GUI.SDSE.RES.0030,
 16 T2S.GUI.SDSE.RES.0040

17 **8.3.3.4.1 Receive Status Advice**

Reference ID	T2S.BPD.STDA.BPTY.03.01
--------------	-------------------------

18 The CSD [Central Bank] receives status advice messages for every change of status to the (un)blocking of
 19 party modification request in T2S.

20 Subsequently, such messages could trigger other internal activities as mentioned below:

- 21 • aligning the status of the (un)blocking of party modification request in the CSD’s or Central Bank’s
- 22 systems with the status in T2S,
- 23 • triggering notification to their relevant clients.

24

1 The CSD [Central Bank] receives the following message from T2S:

2 **Table 8-8: Messages form T2S [T2S.BPD.STDA.BPTY.03.01]**

Message Name	ISO Code	To/From T2S	Event	UDFS Chapter
PartyStatusAdvice V0.1	reda.016.001.01	From T2S	The “Blocking or Party” or “Unblocking of Party” request is “rejected” or “queued” by T2S	3.3.6.10

3 **8.3.3.4.2 Receive Confirmation**

Reference ID	T2S.BPD.STDA.BPTY.03.02
--------------	-------------------------

4 The CSD [Central Bank] receives the confirmation of the processing of (un)blocking of party modification
 5 request in T2S.

6 Subsequently, such messages could trigger other internal activities:

- 7 • aligning the status of the (un)blocking of party modification request in the CSD [Central Bank]’s
- 8 systems with the status in T2S,
- 9 • triggering notification to their relevant clients.

10 The CSD [Central Bank] receives the following message from T2S:

11 **Table 8-9: Messages form T2S [T2S.BPD.STDA.BPTY.03.02]**

Name	ISO Code	To/From T2S	Event	UDFS Chapter
PartyStatusAdvice V0.1	reda.016.001.01	From T2S	T2S “completes” the “blocking of parties” pr “unblocking of party” modification request	3.3.6.10

12

1 **8.4 (UN)BLOCKING OF T2S DEDICATED CASH ACCOUNTS** 2 **[T2S.BPD.STDA.BDCA]**

3 **8.4.1 OVERVIEW**

4 This process describes the act of blocking and unblocking dedicated cash accounts in T2S. Central Banks
5 may need to block dedicated cash accounts in T2S to prevent the settlement (such as trades, repo, corporate
6 actions, intra-balance movements, etc) on these accounts.

7 The T2S dedicated cash account can also be blocked when the cash account is being created. For details on
8 the creation of a dedicated cash account, refer to process “Maintenance of Dedicated Cash Account
9 [T2S.BPD.STDA.MDCA]”.

10 Central Banks in T2S would normally need to unblock a previously blocked T2S dedicated cash account to
11 restore normal processing of relevant instructions (such as trades, Repo, lending and borrowing,
12 reimbursements, etc) and/or settlement restrictions such as intra-balance movements. Central Banks would
13 need to restore such normal processing, when the need for blocking of a T2S dedicated cash account is no
14 longer valid.

15 **Trigger:**

- 16 • Blocking: Business reason to block dedicated cash accounts is identified by the Central Bank.
- 17 • Unblocking: Business reason to block dedicated cash account is no longer valid.

18 **Preconditions**

19 The restriction types related to blocking of dedicated cash accounts have been setup in T2S by the relevant
20 Central Bank.

21 **T2S Instructing Party:**

22 Central Bank

1 **8.4.2 BUSINESS PROCESS DIAGRAM**

2 **Figure 8-4: Business Process Diagram [T2S.BPD.STDA.BDCA]**

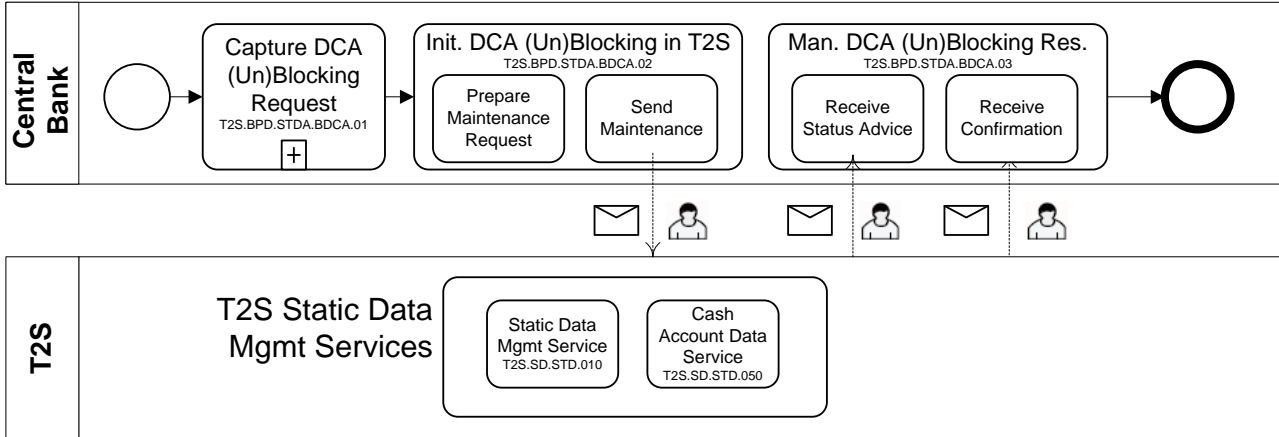

3

4 **8.4.3 BUSINESS PROCESS DESCRIPTION**

5 **8.4.3.1 CAPTURE DEDICATED CASH ACCOUNT (UN)BLOCKING REQUEST**

Reference ID	T2S.BPD.STDA.BDCA.01
--------------	----------------------

6 T2S Actors: Central Bank

7 The Central Bank checks all the details related to (un)blocking of T2S dedicated cash account against the
 8 reference data (maintained by the Central Bank) and may perform additional checks and validations.

9 **8.4.3.2 INITIATE DEDICATED CASH ACCOUNT (UN)BLOCKING IN T2S**

Reference ID	T2S.BPD.STDA. BDCA.02
--------------	-----------------------

10 T2S Actors: Central Bank

11 The Central Bank enriches the (un)blocking of T2S dedicated cash account request with details required in
 12 T2S and sends the blocking of T2S DCA request to T2S using an A2A message (or) by placing the blocking
 13 request in T2S using the T2S GUI (U2A).

14 References:

15 UDFS: Use Case “Restrict Static data” (Chapter 2.21)

16 GUI BFD: Section 4.10 to query and maintain “Intraday Restrictions” in T2S via the T2S GUI

17 T2S.GUI.SDSE.RES.0010, T2S.GUI.SDSE.RES.0020, T2S.GUI.SDSE.RES.0030,
 18 T2S.GUI.SDSE.RES.0040, T2S.GUI.SDSE.RES.0050, T2S.GUI.SDSE.RES.0060

1 **8.4.3.2.1 Prepare Maintenance Request**

Reference ID	T2S.BPD.STDA. BDCA.02.01
--------------	--------------------------

2 *For blocking of dedicated cash account*

3 The Central Bank identifies the applicable restriction type and enriches the blocking of dedicated cash
4 account request accordingly.

5 The Central Bank enriches the blocking of T2S DCA request with specific information such as:

- 6 • T2S dedicated cash account number in T2S,
- 7 • restriction type in T2S for blocking of T2S DCA,
- 8 • validity period of the blocking with valid from and valid till timestamps. For blocking the request in T2S
9 could be place with valid from timestamp only.

10 The Central Bank might want to use the query facilities in the Central Bank or T2S to get the necessary
11 information.

12 In case the Central Bank wants to immediately block the T2S DCA, it has to specify a specific timestamp.

13 *For unblocking of dedicated cash account*

14 The unblocking request takes the form of updating the value of field “valid till” of an existing blocking. T2S
15 will update such a value to define the time of expiry of the blocking request of the T2S dedicated cash
16 account, after successful processing of the unblocking request.

17 In case the Central Bank wants to immediately unblock the T2S DCA, it has to specify a specific timestamp.

18

19 **8.4.3.2.2 Send Maintenance Request**

Reference ID	T2S.BPD.STDA.BDCA.02.02
--------------	-------------------------

20 The Central Bank converts the (un)blocking of dedicated cash account maintenance request into the required
21 message format and transmits it to T2S as an A2A message or by capturing the blocking of T2S dedicated
22 cash account via T2S GUI (U2A).

23 The Central Bank sends the following message to T2S:

24

1 **Table 8-10: Messages to T2S [T2S.BPD.STDA.BDCA.02.02]**

Message Name	ISO Code	To/From T2S	UDFS Chapter
AccountExcludedMandateMaintenanceRequestV01	acmt.015.001.01	To T2S	3.3.1.4

2 **8.4.3.3 T2S PROCESSING**

3 The **Static Data Management Service (T2S.SD.STD.010)** validates the incoming request
 4 (AccountExcludedMandateMaintenanceRequestV01). The **Cash Account Data Service (T2S.SD.STD.050)**
 5 triggers the (un)blocking of the dedicated cash account and informs about the processing result
 6 (AccountRequestAcknowledgementV01).

7 **8.4.3.4 MANAGE DEDICATED CASH ACCOUNT (UN)BLOCKING RESULTS**

Reference ID	T2S.BPD.STDA.BDCA.03
--------------	----------------------

8 T2S Actors: Central Bank

9 The Central Bank receives the (un)blocking of dedicated cash account maintenance related messages, as
 10 responses from T2S and initiates related internal processes.

11 When the Central Bank places a (un)blocking of T2S DCA request via the T2S GUI, the flow of status
 12 advices and confirmations as messages to the Central Bank does not apply. The results of the validation and
 13 processing will be shown in the T2S GUI only.

14 References:

15 UDFS: Use Case “Restrict Static data” (Chapter 2.21)

16 GUI BFD: Section 4.10 to query and maintain “Intraday Restrictions” in T2S via the T2S GUI

17 T2S.GUI.SDSE.RES.0010, T2S.GUI.SDSE.RES.0020, T2S.GUI.SDSE.RES.0030,
 18 T2S.GUI.SDSE.RES.0040, T2S.GUI.SDSE.RES.0050, T2S.GUI.SDSE.RES.0060

19

1 **8.4.3.4.1 Receive Status Advice**

Reference ID	T2S.BPD.STDA.BDCA.03.01
--------------	-------------------------

2 The Central Bank receives status advice messages for every change of status code to the (un)blocking of
 3 dedicated cash account maintenance request in T2S for the results of the validation/processing of the static
 4 data maintenance request.

5 Subsequent to receiving such messages triggers other internal activities might be conducted such as:

- 6 • aligning the status of the blocking of dedicated cash account maintenance request in the Central Bank’s
 7 systems with the status in T2S,
- 8 • triggering notification to their relevant clients.

9 The Central Bank receives the following message from T2S:

10 **Table 8-11: Messages from T2S [T2S.BPD.STDA.BDCA.03.01]**

Message Name	ISO Code	To/From T2S	Event	UDFS Chapter
AccountRequestRe jectionV01	acmt.011.001.01	From T2S	T2S “Rejects” the “blocking of dedicated cash account” or “unblocking of dedicated cash account” maintenance request	3.3.1.3
AccountRequestAc knowledgementV0 1	Acmt.010.001.01	From T2S	T2S “queues” the “blocking of dedicated cash account” or “unblocking of dedicated cash account” maintenance request	3.3.1.2

11 **8.4.3.4.2 Receive Confirmation**

Reference ID	T2S.BPD.STDA.BDCA.03.02
--------------	-------------------------

12 The Central Bank receives and validates the confirmation of the processing of (un)blocking of dedicated cash
 13 account maintenance request.

14 Subsequent to receiving such messages triggers other internal activities as mentioned below:

- 1 • aligning the status of the blocking of dedicated cash account maintenance request in the Central Bank’s
- 2 books with the status in T2S,
- 3 • triggering notification to their relevant clients.

4 The Central Bank receives the following message from T2S:

5 **Table 8-12: Messages from T2S [T2S.BPD.STDA.BDCA.03.02]**

Message Name	ISO Code	To/From T2S	Event	UDFS Chapter
AccountRequestAc knowledgeV0 1	acmt.010.001.01	From T2S	T2S “completes” the “blocking of dedicated cash account” or “unblocking of dedicated cash account” maintenance request	3.3.1.2

6

1 **8.5 (UN)BLOCKING OF RTGS ACCOUNT [T2S.BPD.STD.BRTG]**

2 **8.5.1 OVERVIEW**

3 This process describes the act of blocking and unblocking an RTGS account in T2S. Central Banks in T2S
4 may need to block RTGS accounts for different purposes (e.g. bankruptcy of a Payment Bank). T2S does not
5 allow any settlement on T2S dedicated cash accounts linked to an RTGS account in blocked status, except
6 for those due to Liquidity transfers. For instance as soon as the blocking is processed by T2S, all pending
7 settlement instructions using dedicated cash accounts (for credit or debit) linked to the RTGS account will
8 become ineligible.

9 It is also possible to block an RTGS account directly at the time of its creation. For details on the creation of
10 a RTGS account, refer to process “Maintenance of External RTGS Account [T2S.BPD.STDA.MRAC]”.

11 Central Banks in T2S may need to unblock RTGS accounts because a previous blocking is not relevant
12 anymore and settlement on the linked dedicated cash account can be resumed for settlement instructions and
13 settlement restrictions on cash balance.

14 Alternatively, when blocking an RTGS account by applying the restriction via maintenance request, a valid
15 to date/time can be specified. In the case it is specified and that the date/time is reached, T2S unblocks the
16 RTGS account automatically.

17 **Trigger:**

- 18 • Blocking: Business reason to block an RTGS account is identified by Central Bank (e.g. block all
19 Payment Banks DCAs).
- 20 • Unblocking: Business reason to block RTGS account is no longer valid.

21 **Preconditions:**

22 The restriction types related to blocking of RTGS account are setup in T2S by the relevant Central Bank.

23 **T2S Instructing Party:**

24 Central Bank

1 **8.5.2 BUSINESS PROCESS DIAGRAM**

2 **Figure 8-5: Business Process Diagram [T2S.BPD.STD.BRTG]**

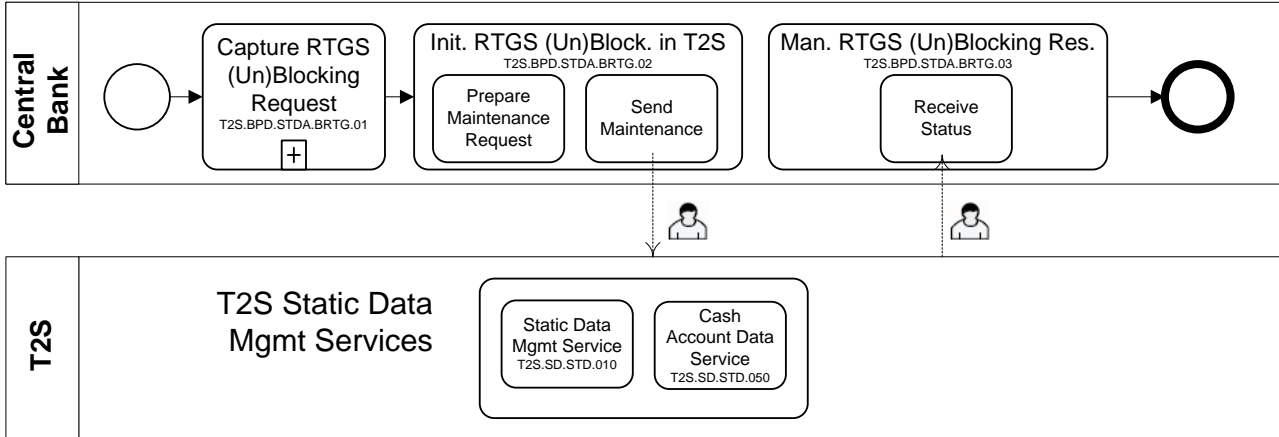

3

4 **8.5.3 BUSINESS PROCESS DESCRIPTION**

5 **8.5.3.1 CAPTURE RTGS ACCOUNT (UN)BLOCKING REQUEST**

Reference ID	T2S.BPD.STD.BRTG.01
--------------	---------------------

6 T2S Actors: Central Bank

7 The Central Bank checks all the details related to the (un)blocking of RTGS account against the reference
8 data (maintained by the Central Bank) and may perform additional checks/ validations.

9 **8.5.3.2 INITIATE RTGS ACCOUNT (UN)BLOCKING IN T2S**

Reference ID	T2S.BPD.STD.BRTG.02
--------------	---------------------

10 T2S Actors: Central Bank

11 The Central Bank enriches the (un)blocking of RTGS request with details required in T2S and sends the
12 request via T2S GUI (U2A).

13 References:

14 GUI BFD: T2S.GUI.SDSE.RGA.0010, T2S.GUI.SDSE.RGA.0020, T2S.GUI.SDSE.RGA.0030,
15 T2S.GUI.SDSE.RGA.0040

16 **8.5.3.2.1 Prepare Maintenance Request**

Reference ID	T2S.BPD.STD.BRTG.02.01
--------------	------------------------

17

1 *For blocking of RTGS account*

2 The Central Bank enriches the blocking of RTGS account request with specific information such as:

- 3 • the identifier of the RTGS account to be blocked,
 4 • restriction type in T2S for blocking of RTGS account,

5 validity period of the blocking with valid from and valid till timestamps. For blocking the request in T2S
 6 could be place with valid from timestamp only. In case the Central Bank wants to immediately block the T2S
 7 DCA, it has to specify a specific timestamp.

8 The Central Bank may want to use the query facilities in their system or T2S to get the necessary
 9 information.

10 *For unblocking of RTGS account*

11 The Central Bank may remove the blocking with immediate effect or at a specific date and time in future
 12 depending upon the business need. There are two ways with which Central Bank can unblock a RTGS
 13 account.

14 Modification of Validity date via maintenance request: In case the Central Bank knows in advance at what
 15 point in time the restriction should be removed, then it can send a maintenance request to modify the Valid
 16 To Date/Time of the relevant blocking restriction. When the time specified will be reached, T2S will remove
 17 the blocking from the RTGS account. In case the Central Bank wants to immediately block the T2S DCA, it
 18 has to specify a specific timestamp.

- 19 • Deletion of the restriction via maintenance request: Otherwise, if the Central Bank needs to unblock
 20 immediately the RTGS account, it can delete the restriction via maintenance request as well.

21 **8.5.3.2.2 Enter Maintenance Request**

Reference ID	T2S.BPD.STD.BRTG.02.02
--------------	------------------------

22 The Central Bank enters the (un)blocking of RTGS request enriched with specific information via the T2S
 23 GUI. No messages are available to (un)block an RTGS account.

24 **8.5.3.3 T2S PROCESSING**

25 The **Static Data Management Service (T2S.SD.STD.010)** validates the request entered via the GUI. The
 26 **Cash Account Data Service (T2S.SD.STD.050)** triggers the (un)blocking of the RTGS account and shows
 27 the result of the processing on the screen.

1 **8.5.3.4 MANAGE RTGS ACCOUNT (UN)BLOCKING RESULTS**

Reference ID	T2S.BPD.STD.BRTG.03
--------------	---------------------

2 T2S Actors: Central Bank

3 The Central Bank views the status of the processing in the T2S GUI.

4 **8.5.3.4.1 Receive Status**

Reference ID	T2S.BPD.STD.BRTG.03.01
--------------	------------------------

5 The Central Bank is notified via screen about the validation/ processing results of the maintenance request
6 via the GUI.

7 Subsequently, other internal activities might be conducted such as:

- 8 • aligning the status of the maintenance instruction,
- 9 • triggering notification to relevant clients,
- 10 • launching analysis after a rejected maintenance request.

1 **9. REPORTING AND QUERIES**

2 **9.1 REPORTS [T2S.BPD.INFO.REPT]**

3 **9.1.1 OVERVIEW**

4 This process describes the act of obtaining reports from T2S. CSDs and CSD Participants as well as Central
5 Banks and Payment Banks may use reports to obtain data from T2S as part of a larger end-to-end business
6 process or in order to perform internal activities such as reconciliation, or as part of their regulatory/audit
7 requirements.

8 Reports need to be configured in advance via the report configuration by the CSDs and Central Banks and
9 are then triggered based on a business or a time event in T2S.

10 When configuring the report, the user can choose to either receive it via A2A message, or to retrieve it via
11 GUI.

12 The latest available data is retrieved. T2S provides a range of predefined reports for different data objects
13 such as securities positions, cash balance, static data, settlement instructions, etc. T2S offers delta reporting
14 for certain report types. These will report the new items between the generation of the previous report and
15 the generation of the delta report. It is to be noted that if the first report generated after a change of business
16 day is a delta report, it will report the changes since the beginning of that day.

17 For some reports, pagination will be available, which means that the retrieved data might be split across
18 several messages in case the maximum size for the message is breached.

19 **Trigger:**

20 The business or time-based event configured for the report has been reached.

21 **Preconditions:**

22 The report has been configured by the T2S Actor.

23 **T2S Instructing Party:**

24 T2S Actors are only recipients.

1 **9.1.2 BUSINESS PROCESS DIAGRAM**

2 **Figure 9-1: Business Process Diagram [T2S.BPD.INFO.REPT]**

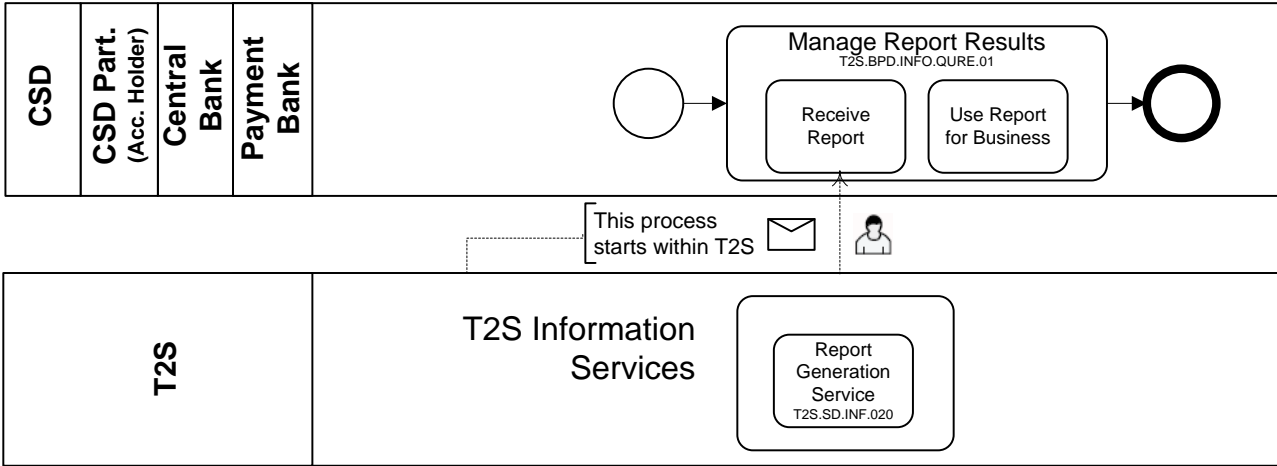

3

4 **9.1.3 BUSINESS PROCESS DESCRIPTION**

5 **9.1.3.1 T2S PROCESSING**

6 The **Report Generation Service (T2S.SD.INF.020)** generates reports based on the previously configured
7 report subscription.

8 **9.1.3.2 MANAGE REPORT RESULTS**

Reference ID	T2S.BPD.INFO.REPT.01
--------------	----------------------

9 T2S Actors: CSD/CSD Participant/Central Bank/Payment Bank

10 The CSD/CSD Participant/Central Bank/Payment Bank receives the report¹²⁶ from T2S and initiates related
11 internal processes.

12 References:

13 UDFS: Use Case “Receive report” (Chapter 2.19)

14 GUI BFD: T2S.GUI.INSE.RPT.0070, T2S.GUI.INSE.RPT.0080, T2S.GUI.INSE.RPT.0090

15 **9.1.3.2.1 Receive Report**

Reference ID	T2S.BPD.INFO.REPT.01.01
--------------	-------------------------

16 The CSD/CSD Participant/Central Bank/Payment Bank receives from T2S the report containing the latest
17 available data for the report type configured.

¹²⁶ Either retrieved via GUI or sent via A2A message depending on report configuration set-up

1 **9.1.3.2.2 Use Report Results for Business Process**

Reference ID	T2S.BPD.INFO.REPT.01.02
--------------	-------------------------

2 The CSD/CSD Participant/Central Bank/Payment Bank extracts the relevant data from the report in order to
3 perform the underlying business process on the participant's side such as:

- 4 • starting a reconciliation of data,
5 • storing the data for audit purposes,
6 • transmitting the information or parts of it to indirectly connected participants.

7

1 9.2 QUERIES [T2S.BPD.INFO.QURE]

2 9.2.1 OVERVIEW

3 This process describes the act of querying T2S. CSDs and CSD Participants as well as Central Banks and
4 Payment Banks may use queries and/or reports to obtain data from T2S as part of a larger end-to-end
5 business process or in order to perform internal activities such as reconciliation, or as part of regulatory/audit
6 requirements. Queries allow the retrieval of data based on pre-defined set of queries and search criteria in a
7 request/response way. T2S provides a range of predefined query types such as securities positions, cash
8 balance, static data, settlement instructions, etc.

9 Generally, all queries are processed in real time. Exceptions occur during the maintenance window and
10 during the night-time period. Queries sent in A2A mode during the maintenance window are queued and
11 answered afterwards. It is not possible to send queries in U2A mode during the maintenance window.
12 Balance queries sent in A2A mode during sequences of the night-time period are queued and answered
13 afterwards. It is not possible to send balance queries in U2A mode during a sequence.

14 In the case of the query result takes too long to be retrieved, a timeout will be sent to the querying party and
15 the request will be processed and responded when T2S finished retrieving the data.

16 In case of oversize¹²⁷, an error will be returned to the querying party notifying that the query result cannot be
17 sent.

18 **Trigger:**

19 T2S Actor identifies need for information, which can be obtained via query

20 **Pre-condition:**

21 None

22 **T2S Instructing Party:**

23 There are four scenarios for the instruction of T2S:

- 24 • CSD instructs T2S.
- 25 • CSD Participant instructs T2S.
- 26 • Central Bank instructs T2S.
- 27 • Payment Bank instructs T2S.

¹²⁷ At Network level, the size of single message/file cannot exceed 32MB.

1 **9.2.2 BUSINESS PROCESS DIAGRAM**

2 **Figure 9-2: Business Process Diagram [T2S.BPD.INFO.QURE]**

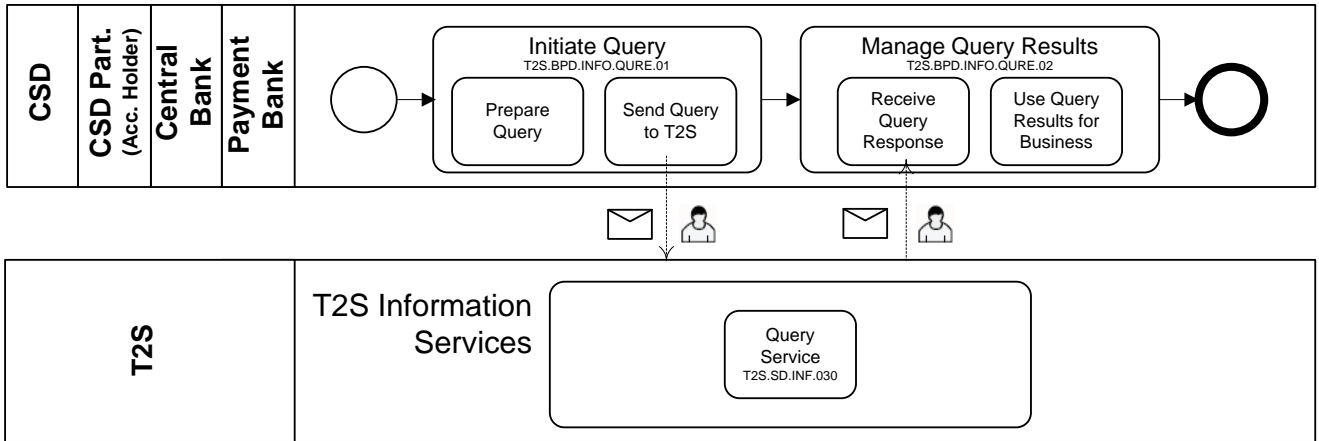

3

4 **9.2.3 BUSINESS PROCESS DESCRIPTION**

5 This Business Process Description is applicable to all scenarios, unless otherwise noted. For the purpose of
6 readability, the actor names in the text refer to Scenario A only.

7 **9.2.3.1 INITIATE QUERY**

Reference ID	T2S.BPD.INFO.QURE.01
--------------	----------------------

8 T2S Actors: CSD/CSD Participant/Central Bank/Payment Bank

9 The CSD (CSD Participant/Central Bank/Payment Bank) selects the search criteria for the query according
10 to the information requested for the business process, formats it in the format expected by T2S and transmits
11 the query via A2A or U2A.

12 References:

13 UDFS: Use Case “Send query” (Chapter 2.18.)

14 **9.2.3.1.1 Prepare Query**

Reference ID	T2S.BPD.INFO.QURE.01.01
--------------	-------------------------

15 The CSD (CSD Participant/Central Bank/Payment Bank) identifies the query type to be used, selects the
16 appropriate search criteria according to the information need of the participant.

17

1 **9.2.3.1.2 Send Query to T2S**

Reference ID	T2S.BPD.INFO.QURE.01.02
--------------	-------------------------

2 The CSD (CSD Participant/Central Bank/Payment Bank) converts the query into the required message
 3 format and transmits the query request to T2S via A2A or U2A.

4 **9.2.3.2 T2S PROCESSING**

5 The **Query Service (T2S.SD.INF.030)** processes queries according to the access rights of the user and sends
 6 the query results or rejection.

7 **9.2.3.3 MANAGE QUERY RESULTS**

Reference ID	T2S.BPD.INFO.QURE.02
--------------	----------------------

8 T2S Actors: CSD/CSD Participant/Central Bank/Payment Bank

9 The CSD (CSD Participant/Central Bank/Payment Bank) receives query response message from T2S and
 10 initiates related internal processes.

11 References:

12 UDFS: Use Case “Send query” (Chapter 2.18.)

13 **9.2.3.3.1 Receive Query Response**

Reference ID	T2S.BPD.INFO.QURE.02.01
--------------	-------------------------

14 The CSD (CSD Participant/Central Bank/Payment Bank) will receive from T2S:

- 15 • a rejection of the previously sent query notifying a failure in the query processing (e.g. due to an invalid
 16 parameter) or,
- 17 • the query result providing the latest available data in accordance with the used search criteria.

18 The reception of the Query Response triggers for instance an analysis after a failed query, or initiates the use
 19 of the data received.

20

1 **9.2.3.3.2 Use Query Results for Business**

Reference ID	T2S.BPD.INFO.QURE.02.02
--------------	-------------------------

2 The CSD (CSD Participant/Central Bank/Payment Bank) extracts the relevant data from the query response
3 in order to perform the underlying business process such as:

- 4 • starting a reconciliation of data
5 • storing the data for audit purposes
6 • transmitting the information or parts of it to indirectly connected participants

1 **10. OPERATIONS AND SUPPORT PROCESSES**

2 **10.1 INVOICING OF CSDS AND CENTRAL BANKS [T2S.BPD.SUPP.INVO]**

3 **10.1.1 OVERVIEW**

4 This process describes invoicing of CSDs and Central Banks.

5 **Trigger:**

6 End of Invoicing period is reached.

7 **Preconditions:**

8 None

9 **T2S Instructing Party:**

10 T2S Actors do not instruct T2S for this process, but are recipients of messages.

11 **10.1.2 BUSINESS PROCESS DIAGRAM**

12 **Figure 10-1: Business Process Diagram [T2S.BPD.SUPP.INVO]**

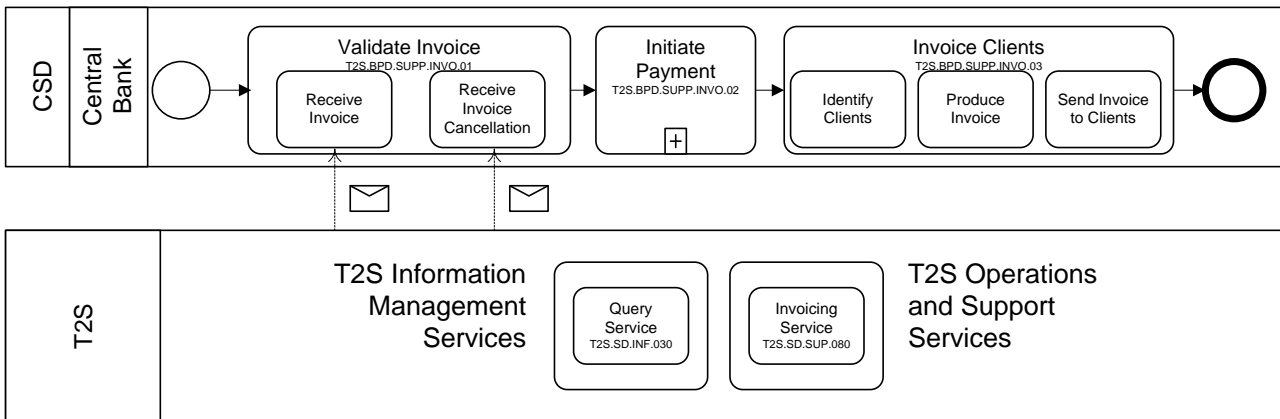

13

14 **10.1.3 BUSINESS PROCESS DESCRIPTION**

15 **10.1.3.1 T2S PROCESSING**

16 The **Invoicing Services (T2S.SD.SUP.080)** creates and sends the invoice and handles of
 17 validation/cancellation of the latter. If additional information is needed, this can be retrieved using the **Query**
 18 **Service (T2S.SD.INF.030)** that allows T2S actors to query detailed information about the billable events on
 19 the T2S platform that can be attributed to specific clients or accounts.

1 **10.1.3.2 VALIDATE INVOICE**

Reference ID	T2S.BPD.SUP.INVO.01
--------------	---------------------

2 T2S Actors: CSD (Scenario A)/Central Bank (Scenario B)

3 This process receives the cumulative invoice from T2S and validates the invoice for further processing, or
 4 receives an invoice cancellation triggered by the T2S operator should the previously sent invoice contain
 5 errors.

6 References:

7 UDFS: Use Cases “Receive Invoice” (Chapter 2.24) and “Receive Invoice Cancellation” (Chapter 2.25)

8 **10.1.3.2.1 Receive Invoice**

Reference ID	T2S.BPD.SUPP.INVO.01.01
--------------	-------------------------

9 T2S Actors: CSD (Scenario A)/Central Bank (Scenario B)

10 The CSD [Central Bank] receives the cumulative invoice from T2S. It triggers on the CSD [Central Bank]
 11 side the process of validating the invoice against the expected amount to be billed for the period covered by
 12 the invoice.¹²⁸ The output of this activity is either to initiate the payment if the CSD [Central Bank] validates
 13 the invoice, or receive the invoice cancellation from T2S (triggered by the T2S operator) in case of rejection
 14 of the invoice.

15 The invoice sent by T2S covers the following non-exhaustive information:

- 16 • invoice reference,
- 17 • period covered by the invoice and payment due date,
- 18 • total amount of the invoice in EUR,
- 19 • total amount per service category in EUR,
- 20 • total number of items per service category,
- 21 • price per item unit in EUR,
- 22 • total amount per item in EUR.

23 The CSD [Central Bank] receives the following message form T2S:

24

¹²⁸ T2S sends monthly invoices. The T2S operator can exceptionally also send invoices for periods shorter than the monthly period based on request from the CSD or Central Bank.

1 **Table 10-1: Messages from T2S [T2S.BPD.SUPP.INVO.01.01]**

Name	ISO Code	From/To T2S	Event	UDFS Chapter
BillingReport "Invoice"	Camt.077.001.01	From T2S	Invoice processing completed after the end of the billing period	3.3.3.31

2 **10.1.3.2.2 Receive Invoice Cancellation**

Reference ID	T2S.BPD.SUPP.INVO.01.02
--------------	-------------------------

3 If the T2S Operator cancels a previously sent invoice due to errors detected by the T2S Operator, the CSD
 4 [Central Bank] receives the invoice cancellation from T2S. The invoice cancellation refers to the previously
 5 sent erroneous invoice and otherwise contains the same information as the cancelled invoice.

6 The CSD [Central Bank] receives the following message form T2S:

7 **Table 10-2: Messages from T2S [T2S.BPD.SUPP.INVO.01.02]**

Name	ISO Code	From/To T2S	Event	UDFS Chapter
BillingReport "Invoice cancellation"	Camt.077.001.01	From T2S	Cancellation of the invoice by the T2S Operator	3.3.3.31

8 **10.1.3.3 INITIATE PAYMENT**

Reference ID	T2S.BP.SUPP.INVO.02
--------------	---------------------

9 T2S Actors: CSD (Scenario A)/Central Bank (Scenario B)
 10 The CSD [Central Bank] initiates the payment in EUR for the previously validated invoice via Target2. The
 11 exact procedure will be defined later in the process.

12 **10.1.3.4 INVOICE CLIENTS**

Reference ID	T2S.BPD.SUPP.INVO.03
--------------	----------------------

13 T2S Actors: CSD (Scenario A)/Central Bank (Scenario B)
 14 The CSD [Central Bank] produces the invoices for the clients of the CSDs and Central Banks.
 15 References:
 16 UDFS: Use Case "Send Query" (Chapter 2.18)
 17 GUI BFD: T2S.GUI.OSSE.BIL.0010, T2S.GUI.OSSE.BIL.0020, T2S.GUI.OSSE.BIL.0030

1 **10.1.3.4.1 Identify Clients**

Reference ID	T2S.BPD.SUPP.INVO.03.01
--------------	-------------------------

2 The CSD [Central Bank] identifies the respective amounts to be billed to its clients. The CSD or Central
 3 Bank can either use its own data or use the information in the invoice from T2S or request additional
 4 information from the T2S system via query¹²⁹.

5 **10.1.3.4.2 Produce Invoice**

Reference ID	T2S.BPD.SUPP.INVO.03.02
--------------	-------------------------

6 The CSD [Central Bank] compiles the data retrieved and produces invoices for its clients.

7 **10.1.3.4.3 Send Invoice To Clients**

Reference ID	T2S.BPD.SUPP.INVO.03.03
--------------	-------------------------

8 The CSD [Central Bank] sends the invoice to its client in the format specified by their bilateral agreement
 9 which triggers the payment on the client's side.

10

¹²⁹ The Itemised billing data query allows retrieving the detail of a previously received invoice per CSD or Central Bank client, it allows as well to receive this information per Securities Account or Dedicated cash account. See UDFS section 3.3.3.29 and 3.3.3.30.

1 **10.2 ACCESS TO ARCHIVED DATA [T2S.BPD.SUPP.ARCH]**

2 **10.2.1 OVERVIEW**

3 This process describes the act of retrieving archived data from the T2S Operator. T2S archives the files and
4 instructions three months after they reach their final status. The archived data include static and transactional
5 data.

6 The CSD or Central Bank can send a request to T2S operator, with the details of the data they require. T2S
7 operator will retrieve the requested archived data from the T2S system, and send it to the requesting CDS or
8 Central Bank.

9 **Trigger:**

10 The CSD or Central Bank realised the need to access specific archived data.

11 **Preconditions:**

12 None

13 **T2S Instructing Party:**

14 There are two scenarios for the instruction of T2S:

- 15 • Scenario A: CSD instructs T2S.
16 • Scenario B: Central Bank instructs T2S.

1 **10.2.2 BUSINESS PROCESS DIAGRAM**

2 **Figure 10-2: Business Process Diagram [T2S.BPD.SUPP.ARCH]**

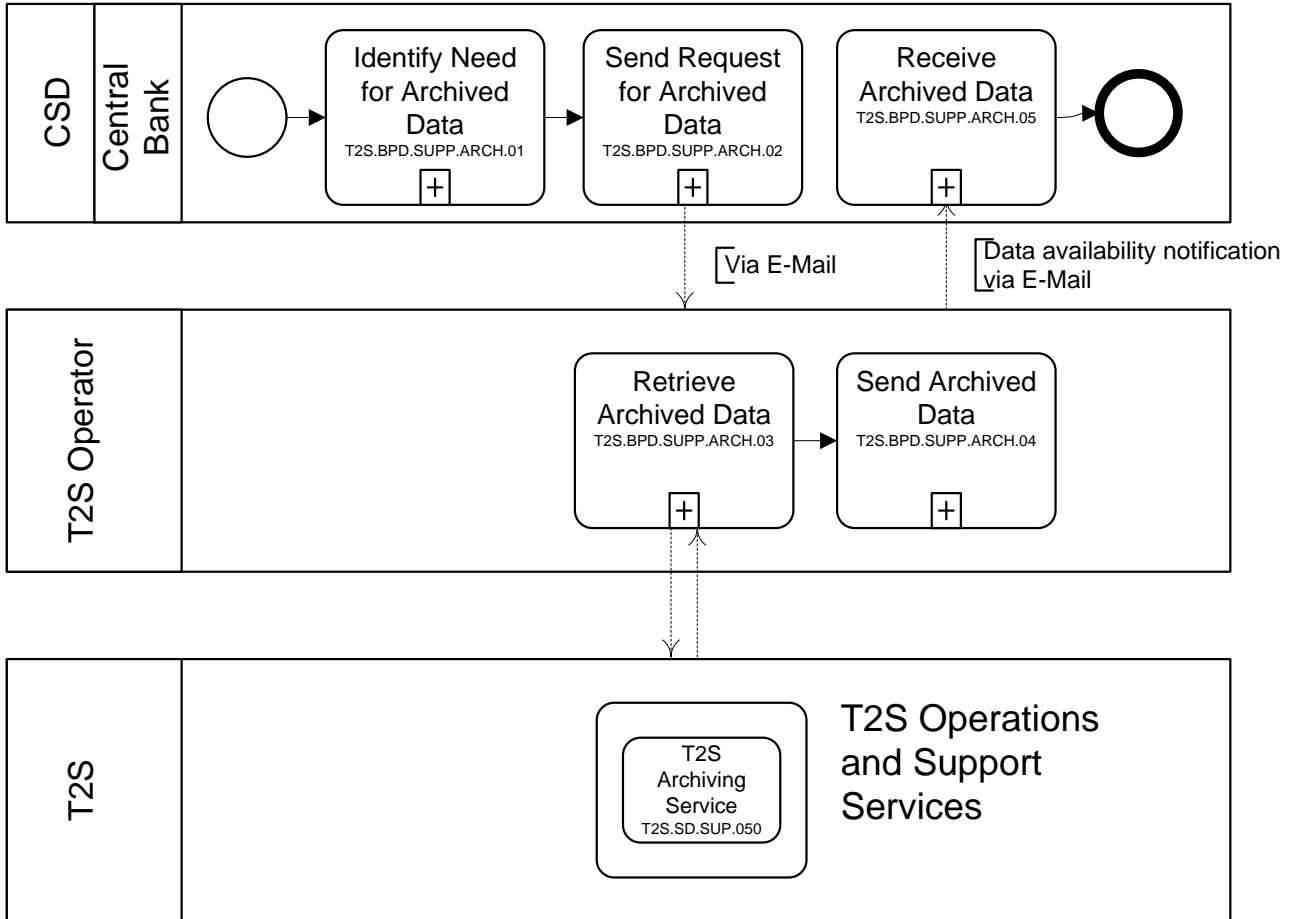

3

4 **10.2.3 BUSINESS PROCESS DESCRIPTION**

5 **10.2.3.1 IDENTIFY NEED FOR ARCHIVED DATA**

Reference ID	T2S.BPD.SUPP.ARCH.01
--------------	----------------------

6 T2S Actors: CSD (Scenario A)/Central Bank (Scenario B)

7 The CSD [Central Bank] identifies the need for retrieving archived data from T2S. This could be because of
 8 a request for data e.g. from regulatory authorities or from its participants, and the CSD [Central Bank] does
 9 not have the required data in its own books.

10 **10.2.3.2 SEND REQUEST FOR ARCHIVED DATA**

Reference ID	T2S.BPD.SUPP.ARCH.02
--------------	----------------------

11 T2S Actors: CSD (Scenario A)/Central Bank (Scenario B)

1 The CSD [Central Bank] prepares a precise definition/description of the required data, and sends a request to
 2 T2S for the archived data. The archived data request will be outside of the T2S system (e.g. e-mail, fax etc).

3 **10.2.3.3 RETRIEVE ARCHIVED DATA**

Reference ID	T2S.BPD.SUPP.ARCH.03
--------------	----------------------

4 T2S Actors: T2S Operator
 5 The T2S Operator retrieves the archived data from the T2S archive based on the request parameters creating
 6 one or more files.

7 **10.2.3.4 T2S PROCESSING**

8 **The T2S Archiving Service (T2S.SD.SUP.050)** archives static and dynamic data that has reached its final
 9 status and retrieves the data upon request

10 **10.2.3.5 SEND ARCHIVED DATA**

Reference ID	T2S.BPD.SUPP.ARCH.04
--------------	----------------------

11 T2S Actors: T2S Operator
 12 The T2S Operator sends a notification that the retrieved archived data is available to the requesting CSD
 13 [Central Bank]. Depending on the size of data both sides agree on the best way to transfer the archived data
 14 to the requesting CSD [Central Bank].
 15 Alternatively, the T2S Operator could send information to the CSD [Central Bank] stating, that there is no
 16 archived data, which is compliant with the specified criteria.

17 **10.2.3.6 RECEIVE ARCHIVED DATA**

Reference ID	T2S.BPD.SUPP.ARCH.05
--------------	----------------------

18 T2S Actors: CSD (Scenario A)/Central Bank (Scenario B)
 19 The CSD [Central Bank] receives the archived data from the T2S Operator.

1 10.3 APPROVAL OR REVOCATION OF REQUESTS SUBJECT TO THE FOUR- 2 EYE-PRINCIPLE [T2S.BPD.SUPP.FEYE]

3 10.3.1 OVERVIEW

4 This process describes the act of approving or revoking a request that is subject to the Four-Eye-Principle.
5 The request can be either a static data request or a dynamic¹³⁰ data request.

6 T2S allows the administrators of CSD, CSD Participants, Central Bank and Payment Banks to define for the
7 privileges they grant to the users falling under their responsibility a binary setting that specifies whether the
8 privilege and its associated functionality in T2S is subject to 4 eye principle.

9 Only the requests submitted in U2A can be subject to the Four-Eye-Principle. The Four-Eye-Principle is not
10 applicable to privileges related to queries and reports. Yet, the Four-Eye-Principle related privileges can
11 include any functionality related to static data or transactional data in T2S.

12 For example a CSD administrator could define that the privilege “send settlement instruction” should be
13 subject to 4 eye principle when granting this privilege to one of its user. This action would result in a two
14 step approach when this user send a settlement instruction to T2S, i.e. the instruction will be validated by
15 T2S once a second user of the CSD will have “approved” the request. The second user can as well revoke the
16 request in case the action is not allowed. After the second user has approved the request, the life cycle of the
17 request is the same as for Two-Eye-Principle requests.

18 It must be possible for an authorised T2S system user to

- 19 • identify all static and dynamic data changes awaiting approvals,
- 20 • search for specific static and dynamic data changes,
- 21 • search and display historic change information, both approved and rejected changes,
- 22 • and approve and reject static and dynamic data changes.

23 **Trigger:**

24 Some actions have been performed by a user of a CSD, CSD Participant, Central Bank or Payment Bank that
25 requires approval by a second user of the same entity.

26 **Pre-condition:**

27 Roles and privileges properly defined in T2S.

28 **T2S Instructing Party:**

29 The so-called “Four Eye User” instructs T2S.

¹³⁰ For instance transactional requests

1 **10.3.2 BUSINESS PROCESS DIAGRAM**

2 **Figure 10-3: Business Process Diagram [T2S.BPD.SUPP.FEYE]**

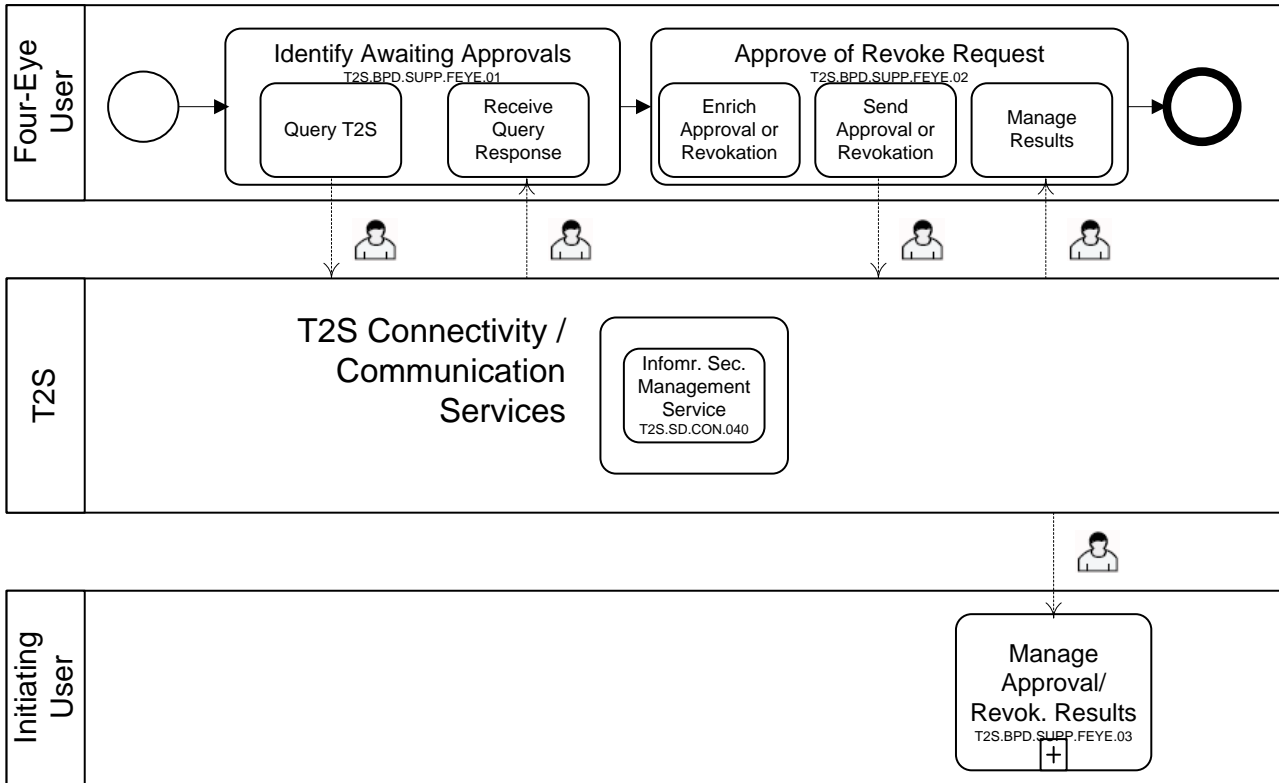

3

4 **10.3.3 BUSINESS PROCESS DESCRIPTION**

5 **10.3.3.1 IDENTIFY AWAITING APPROVALS**

Reference ID	T2S.BPD.SUPP.FEYE.01
--------------	----------------------

6 T2S Actors: Four Eye User¹³¹

7 The Four Eye User identifies the request(s) pending for its approval via queries available via the T2S GUI.

8 No messages are available for these activities in T2S.

9 References:

10 GUI BFD: T2S.GUI.OSSE.APR.0010, T2S.GUI.OSSE.APR.0020, T2S.GUI.OSSE.APR.0030

11 **10.3.3.1.1 Query T2S**

Reference ID	T2S.BPD.SUPP.FEYE.01.01
--------------	-------------------------

¹³¹ User belongs to either a CSD, CSD Participant, Central Bank or Payment Bank.

1 The Four Eye User selects the search criteria relevant for the query it wants to perform and enters into T2S
 2 GUI the relevant search criteria and submits the request.

3 It is possible to identify changes awaiting approval by:

- 4 • the type of data (e.g. static data or dynamic data),
- 5 • the period in which the request was made,
- 6 • the user Id of the person who performed an update,
- 7 • and by a specific mnemonic (e.g. ISIN, account number).

8 **10.3.3.1.2 T2S Processing**

9 The **Query Service (T2S.SD.INF.030)** processes queries according to the access rights of the user and sends
 10 the query results or rejection.

11 **10.3.3.1.3 Received Query Response**

Reference ID	T2S.BPD.SUPP.FEYE.01.02
--------------	-------------------------

12 The Four Eye User receives on its screen the query results or an error. In case of multiple pending approval
 13 requests, a list will be provided. It is possible to see the details for each of the pending request.

14 The T2S response triggers the relevant process on the four eye user side, for instance:

- 15 • submitting a new query in case of error or no result found,
- 16 • initiating analysis for approval or revocation of the pending request(s).

17 **10.3.3.2 APPROVE OR REVOKE PENDING REQUEST**

Reference ID	T2S.BPD.SUPP.FEYE.02
--------------	----------------------

18 T2S Actors: Four Eye User

19 The Four Eye User analyses whether the submitted request(s) can be approved and submit the approval via
 20 the T2S GUI. If not the four eye user revokes the pending request.

21 References:

22 GUI BFD: T2S.GUI.OSSE.APR.0040

23

1 **10.3.3.2.1 Enrich Approval or Revocation**

Reference ID	T2S.BPD.SUPP.FEYE.02.01
--------------	-------------------------

2 The Four Eye User analyses whether the pending requests can be approved for further processing in T2S. It
 3 can use other queries in T2S to get additional information, or use information in its system.

4 **10.3.3.2.2 Send Approval or Revocation**

Reference ID	T2S.BPD.SUPP.FEYE.02.02
--------------	-------------------------

5 The Four Eye User submits the approval or revocation via the T2S GUI.

6 **10.3.3.2.3 T2S Processing**

7 The **Information Security Management Service (T2S.SD.CON.040)** identifies requests subject to the four
 8 eye principle and handles the approval or rejection thereof.

9 **10.3.3.2.4 Manage Result**

Reference ID	T2S.BPD.SUPP.FEYE.02.03
--------------	-------------------------

10 The Four Eye User receives the T2S response for the previous submission.

11 It triggers the relevant processes on the 4 eye user side.

12 **10.3.3.3 MANAGE APPROVAL OR REVOCATION RESULTS**

Reference ID	T2S.BPD.SUPP.FEYE.03
--------------	----------------------

13 T2S Actors: Initiating User

14 The Initiating User is notified via GUI of the result of the four eye validation. It triggers the relevant
 15 processes on the initiating user side. For instance in case of approval, it will trigger the further processing in
 16 T2S of the submitted request.

1 **11. APPENDICES**

2 **11.1 READING GUIDE TO THE BPD**

3 This guide aims at illustrating the reading of the Business Process Diagram in conjunction with the Business
4 Process Description using the examples of the “Intra-CSD Settlement [T2S.BPD.SETT.ICSD]” and
5 “Reservation and Blocking of Cash Balance [T2S.BPD.SETT.RBCB]” processes. It is to be along with the
6 Introduction.

7 **11.1.1 GENERAL READING GUIDELINES**

- 8 • Begin by starting to read the first pool of the Business Process Diagram. This pool usually represents the
9 T2S Actor who will instruct T2S i.e. the T2S instructing party. An exception to this occurs only when
10 the process is started form within T2S. These cases are specifically highlighted with a comment “Process
11 starts within T2S” (e.g. process “Reports [T2S.BPD.INFO.REPT]”).

1 **Figure 11-1: Intra-CSD Settlement with instruction by CSD only**

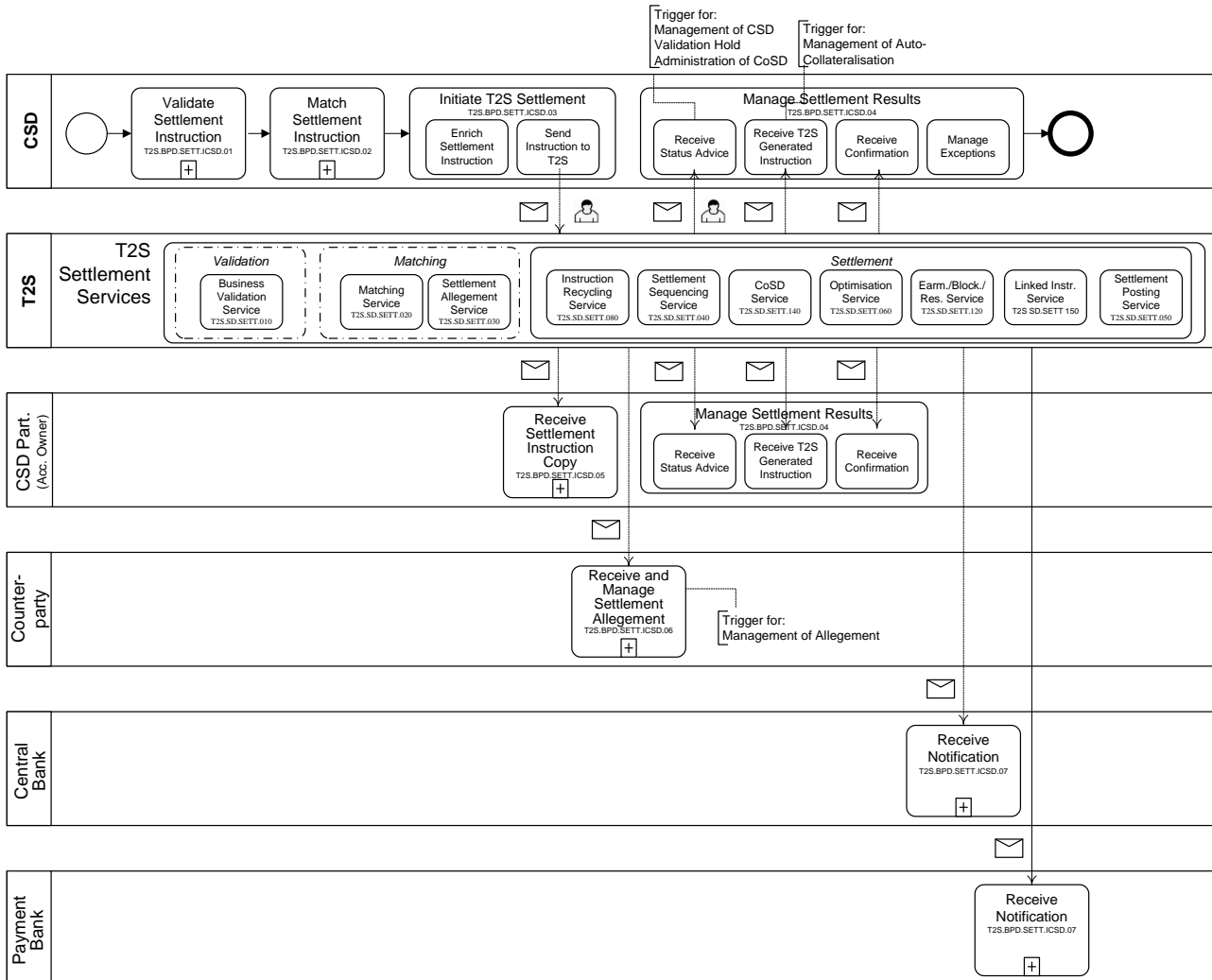

- 2
- 3 • Read along the sub-processes and their tasks.
- 4 ○ There are sub-processes, which are not split into tasks as they represent sub-processes internal to the
- 5 respective T2S actor.
- 6 ○ Other sub-processes, so-called collaborative sub-processes, are divided into tasks. These processes
- 7 are the ones involving T2S interaction.
- 8 ○ In the example below the first sub-process “Validate Settlement Instruction” is an internal sub-
- 9 process at the CSD and is hence not detailed further. The same holds true for the second sub-process
- 10 “Match Settlement Instruction”. The third sub-process “Initiate T2S Settlement” is a collaborative
- 11 sub-process involving interaction with T2S.
- 12 ○ The interaction with T2S is represented by the dotted arrows to or from T2S. You can identify
- 13 whether interaction is possible via A2A or U2A by reading the symbols i.e. mail symbol for A2A
- 14 interaction and user symbol for U2A interaction.

- 1 • In order to understand the other T2S Actors’ involvement in the process read along the sub-processes
2 and activities of the remaining pools of the process. These pools illustrate the messages received by the
3 other T2S Actors as a result of the process. In the example the counterpart might receive a settlement
4 allegement (“Receive and Manage Settlement Allegement”), whereas the Central Bank and Payment
5 Bank receive notifications from T2S (“Receive Notification”).
- 6 • To get more information on the sub-processes and activities, read the corresponding descriptions in the
7 section “Business Process Description”.
 - 8 ○ The IDs used will enable you to find the correct activity.
 - 9 ○ The hierarchy represented in the Business Process Diagram is maintained for the Business Process
10 Description. In the example, the sub-process “Initiate T2S Settlement” is described on a generic
11 level first, the two tasks belonging to this sub-process (“Enrich Settlement Instruction” and “Send
12 Instruction to T2S”) are subsequently detailed.
 - 13 ○ Whether an activity description refers to a sub-process or a task can also be identified using the ID as
14 tasks have a lower level of numbering (e.g. T2S.BPD.SETT.ICSD.03.01) than sub-processes (e.g.
15 T2S.BPD.SETT.ICSD.03).
 - 16 ○ In order to get more information on the interaction with T2S, refer to the message tables shown for
17 all collaborative activities. They include multiple references to the UDFS, in order to enable you to
18 find more details quickly.
- 19 • The pool “T2S” details the T2S services involved in the process. Details on how these services interact
20 with one another are described in the activity “T2S Processing” (or “Initial T2S Processing” for
21 processes started within T2S

22 11.1.2 READING OF SCENARIOS

23 For many processes there are several options as to who can instruct T2S. In the sample process “Intra-CSD
24 Settlement” the CSD can instruct T2S, but also any other CSD Participant e.g. a bank or custodian or CCP.
25 Likewise in the process “Reservation and blocking of cash balance either the Central Bank or the Payment
26 Bank can instruct T2S. In almost all processes the activities and messages used for interaction with T2S do
27 not differ. In order to avoid repetitions while accounting for the different possibilities of instruction, the
28 scenario notation is used.

- 29 • The scenario notation can immediately be identified by the number of T2S Actors listed on the left side
30 of the first pool. If more than one T2S Actor is listed, the scenario notation has been applied.
- 31 • Reading scenarios does not differ much from reading other processes; therefore the “General Reading
32 Guidelines” above apply. The only challenging aspect is the identification of the correct T2S actor
33 executing an activity.

- 1 • First of all, look at the T2S Actors that can instruct T2S and determine which scenario would want to read.
- 2 In the example “Intra-CSD Settlement” you have the choice between reading the processes from the perspective of a CSD instructing T2S or a CSD Participant instructing T2S. For the example
- 3 from the perspective of a CSD instructing T2S or a CSD Participant instructing T2S. For the example
- 4 “Reservation and blocking of cash balance” you can choose between the Central Bank and the Payment
- 5 Bank instructing T2S.

6 **Figure 11-2: Intra-CSD Settlement with both options for instruction**

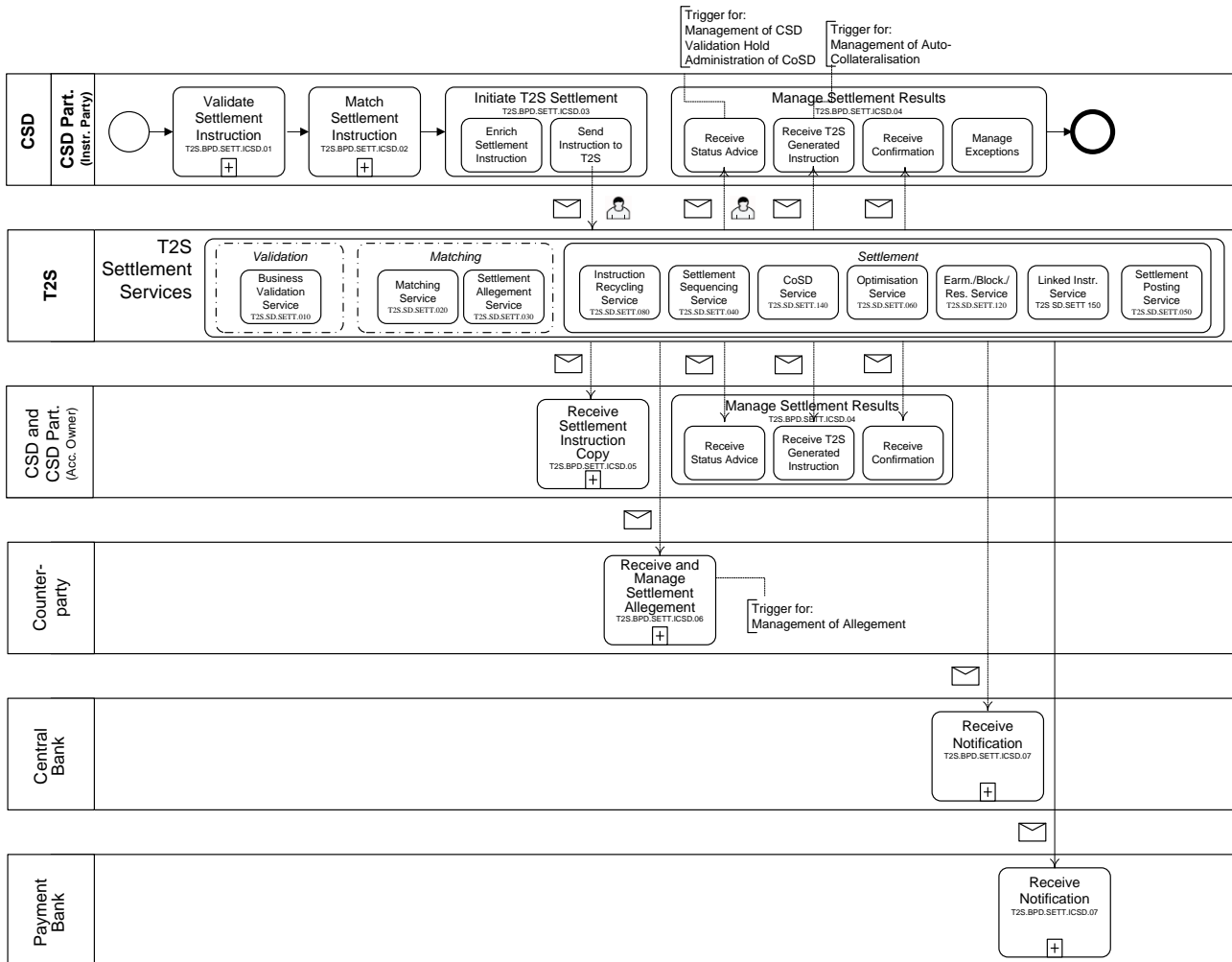

7

1 **Figure 11-3: Reservation and Blocking of Cash Balance**

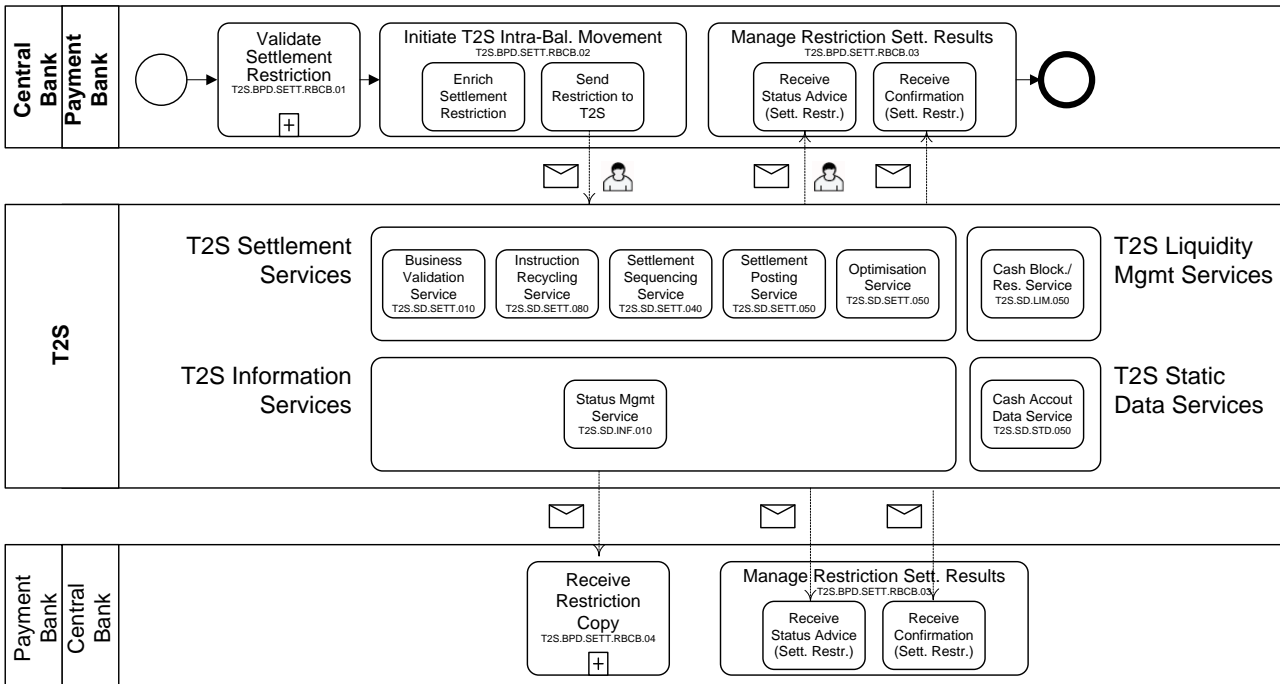

- 2
- 3 • Once you have identified the instructing party, follow the reading of this pool as described in the
- 4 “General reading Guidelines” above.
- 5 • If you want to read another pool, you need to identify first the actor for which this pool applies in your
- 6 chosen scenario. This is done by following the “column” or your instructing party down to the other
- 7 pool.
- 8 ○ In many processes, the T2S actors in this pool are the same for both scenarios and no further
- 9 differentiation needs to be made. For instance, in the process “Intra-CSD Settlement” the third pool
- 10 always applies to the CSD as well as account-owing CSD Participant.
- 11 ○ Only in a few cases the T2S actors differ depending on the scenario you have chosen. For example,
- 12 in the process “Reservation and blocking of cash balance”, if you follow the column of the Central
- 13 Bank, the third pool refers to the Payment Bank. If you read the first pool from the perspective of the
- 14 Central Bank (instructing T2S), the third pool needs to be read from the perspective of the Payment
- 15 Bank. The same applies if you chose the other T2S actor listed in the first pool for your scenario: if
- 16 you read the first pool from the perspective of the Payment Bank (instructing T2S), the third pool
- 17 needs to be read from the perspective of the Central Bank.

18

1 **11.2 INDEX OF PROCESSES**

2 The following table summarised the T2S actors involved in each business process.

- 3 • I (Instructing Party): the T2S actor can instruct T2S for this business process;
- 4 • R (Recipient): the T2S actor receives messages from T2S out of this business process;
- 5 • (I) indicates that the CSD or CSD Participant need to have a specific role in order to be involved in the
- 6 process, in this case the role is detailed in the “comment” column.

7 **Table 11-1: Overview of T2S actors' involvement in business processes**

Process	CSD	CSD Part.	Central Bank	Payment Bank	Comment
Core Settlement Processes					
Intra-CSD Settlement [T2S.BPD.SETT.ICSD]	I	I	R	R	
Cross-CSD Settlement (with CSD inside T2S) [T2S.BPD.SETT.CCSD]	I	I	R	R	
External CSD Settlement (involving CSD outside T2S) [T2S.BPD.ECSD]	I	I	R	R	
Supporting Settlement Processes					
Management of Allegement [T2S.BPD.SETT.ALEG]	I	I			
Management of CSD Validation Hold [T2S.BPD.SETT.CSDH]	I				
Administration of Conditional Securities Delivery [T2S.BPD.SETT.COSD]	R/(I)			R	CoSD Admin. Party
Management of Auto-Collateralisation [T2S.BPD.SETT.ACOL]	R	I	R	R	
Reservation or Blocking of Securities Position [T2S.BPD.SETT.RBSP]	I	I			
Unreservation or Unblocking of Securities Position [T2S.BPD.SETT.UUSP]	I	I			
Earmarking of Securities Position [T2S.BPD.SETT.EARM]	I	I			
Unearmarking of Securities Position [T2S.BPD.SETT.UEAR]	I	I			
Reservation or Blocking of Cash Balance [T2S.BPD.SETT.RBCB]			I	I	

Process	CSD	CSD Part.	Central Bank	Payment Bank	Comment
Unreservation or Unblocking of Cash Balance [T2S.BPD.SETT.UUCB]			I	I	
Hold of Settlement Instruction [T2S.BPD.SETT.HOLD]	I	I			
Release of Settlement Instruction [T2S.BPD.SETT.RELE]	I	I			
Cancellation of Settlement Instruction [T2S.BPD.SETT.CINS]	I	I			
Cancellation of Intra-Position Movement [T2S.BPD.SETT.CIPM]	I	I			
Cancellation of Intra-Balance Movement [T2S.BPD.SETT.CIBM]			I	I	
Amendment of Settlement Instruction or Restriction [T2S.BPD.SETT.AINS]	I	I	I	I	
Account Allocation [T2S.BPD.SETT.AALO]	I	I	R	R	
Pledging of Securities [T2S.BPD.SETT.PLED]	I	I			
Asset Services Processes					
Repurchase Agreements [T2S.BPD.SETT.REPO]	I	I	R	R	
Issuance of Securities [T2S.BPD.SETT.ISSU]	I	R			
Securities Lending and Borrowing [T2S.BPD.SETT.LEND]	I	I	R	R	
Back-to-back Trades [T2S.BPD.SETT.BTOB]	I	I	R	R	
Basket Trades [T2S.BPD.SETT.BASK]	I	I	R	R	
Coupon Stripping [T2S.BPD.SETT.CSTR]	I	R	R	R	
Coupon Reconstitution [T2S.BPD.SETT.CREC]	I	R	R	R	
Buy In and Sell Out [T2S.BPD.SETT.BISO]		(I)			CCP
Mark-up/ Mark-Down of Securities Positions [T2S.BPD.SETT.MKUP]	I	I			
Fund Shares Subscription [T2S.BPD.SETT.FNDS]		(I)			Fund Instr.& Transfer Agent
Account Transfer of Securities [T2S.BPD.SETT.ATRA]	I	R			

Process	CSD	CSD Part.	Central Bank	Payment Bank	Comment
Corporate Actions Processes					
Securities Distributions [T2S.BPD.SETT.SECD]	I	R			
Cash Distributions [T2S.BPD.SETT.CSHD]	I	R	R	R	
Distribution with Options [T2S.BPD.SETT.CHOS]	I	R	R	R	
Mandatory Reorganisations [T2S.BPD.SETT.MAND]	I	R	R	R	
Voluntary Reorganisations [T2S.BPD.SETT.VOLU]	I	R	R	R	
Mandatory Reorganisations with Options [T2S.BPD.SETT.RGOP]	I	R	R	R	
Market Claims [T2S.BPD.SETT.MCLA]	I	R	R	R	
Transformations [T2S.BPD.SETT.TRAN]	I	R	R	R	
Buyer Protection [T2S.BPD.SETT.BPRO]	I	R	R	R	
Liquidity Management Processes					
Transfer of Liquidity from RTGS to T2S [T2S.BPD.LQMG.INBD]			I	R	
Intraday Transfer of Liquidity from T2S to RTGS [T2S.BPD.LQMG.OTBD]			I	I	
Multiple Liquidity Provider Transfer of Liquidity from T2S to RTGS [T2S.BPD.LQMG.MLPT]			I	R	
Transfer of Liquidity within T2S [T2S.BPD.LQMG.INLT]			R	I	
End of Day Cash Management [T2S.BPD.LQMT.EODC]			R	R	
Static Data Maintenance Processes					
Maintenance of Securities [T2S.BPD.STDA.MSEC]	I				
Maintenance of Securities Account [T2S.BPD.STDA.MSAC]	I				
Maintenance of CSD Participant [T2S.BPD.STDA.MPTY]	I				
Maintenance of Payment Bank [T2S.BPD.STDA.MPBK]			I		

Process	CSD	CSD Part.	Central Bank	Payment Bank	Comment
Maintenance of Dedicated Cash Account [T2S.BPD.STDA.MDCA]			I		
Maintenance of External RTGS Account [T2S.BPD.STDA.MRAC]			I		
Maintenance of Message Subscription [T2S.BPD.STDA.MMSG]	I		I		
Maintenance of Report Subscription [T2S.BPD.STDA.MREP]	I	I	I	I	
Maintenance of Roles [T2S.BPD.STDA.MROL]	I	I	I	I	
Maintenance of Restrictions [T2S.BPD.STDA.MRES]	I		I		
Maintenance of CoSD Parameters [T2S.BPD.STDA.MCOS]	I				
Maintenance of Cross-CSD Settlement Link and Securities Eligibility [T2S.BPD.STDA.MCSL]	I				
Maintenance of Multiple Liquidity Providers [T2S.BPD.STDA.MMLP]			I	I	
Maintenance of Standing/Predefines Liquidity Transfer Orders [T2S.BPD.STDA.MLTO]			I	I	
Maintenance of Auto-Collateralisation Eligibility [T2S.BPD.STDA.MACE]			I	I	
Maintenance of Market Specific Attributes [T2S.BPD.STDA.MMSA]	I		I		
Maintenance of System User [T2S.BPD.STDA.MUSE]	I	I	I	I	
Management of Limits [T2S.BPD.STDA.MLIM]			I	I	
Static Data Restriction Processes					
(Un)Blocking of Securities [T2S.BPD.STDA.BSEC]	I				
(Un)Blocking of Securities Account [T2S.BPD.STDA.BSAC]	I				
(Un)Blocking of Party [T2S.BPD.SETT.BPRT]	I		I		
(Un)Blocking of T2S Dedicated Cash Accounts [T2S.BPD.STDA.BDCA]			I		

Process	CSD	CSD Part.	Central Bank	Payment Bank	Comment
(Un)Blocking of RTGS Account [T2S.BPD.STD.BRTG]			I		
Reporting And Queries					
Reports [T2S.BPD.INFO.REPT]	I	I	I	I	
Queries [T2S.BPD.INFO.QUIRE]	I	I	I	I	
Operations and Support Processes					
Invoicing of CSDs and Central Banks [T2S.BPD.SUPP.INVO]	R		R		
Access to Archived Data [T2S.BPD.SUPP.ARCH]	I		I		
Approval or Revocation of Requests Subject to the Four-Eye-Principle [T2S.BPD.SUPP.FEYE]	(I)	(I)	(I)	(I)	Four-Eye User

1 11.3 INDEX OF FIGURES

2 FIGURE 1-1: EXAMPLE OF SCENARIOS 14

3 FIGURE 1-2: EXAMPLE OF A VARIATION 16

4 FIGURE 2-1: BUSINESS PROCESS DIAGRAM [T2S.BPD.SETT.ICSD]..... 18

5 FIGURE 2-2: BUSINESS PROCESS DIAGRAM [T2S.BPD.SETT.CCSD]..... 31

6 FIGURE 2-3: EXTERNAL-CSD SETTLEMENT - BUSINESS SCENARIO 1 41

7 FIGURE 2-4: EXTERNAL-CSD SETTLEMENT - BUSINESS SCENARIO 2 42

8 FIGURE 2-5: EXTERNAL-CSD SETTLEMENT - BUSINESS SCENARIO 3 43

9 FIGURE 2-6: EXTERNAL-CSD SETTLEMENT - BUSINESS SCENARIO 4 44

10 FIGURE 2-7: EXTERNAL-CSD SETTLEMENT WITH BOTH INVESTOR CSDs IN T2S AND THE ISSUER CSD OUTSIDE T2S 45

11 FIGURE 2-8: BUSINESS PROCESS DIAGRAM [T2S.BPD.SETT.ECSD/VAR. 1]..... 46

12 FIGURE 2-9: EXTERNAL CSD SETTLEMENT WITH ONE INVESTOR CSD IN T2S AND THE ISSUER CSD OUTSIDE T2S..... 56

13 FIGURE 2-10: BUSINESS PROCESS DIAGRAM [T2S.BPD.SETT.ECSD/VAR. 2]..... 58

14 FIGURE 3-1: BUSINESS PROCESS DIAGRAM [T2S.BPD.SETT.ALEG] 70

15 FIGURE 3-2: BUSINESS PROCESS DIAGRAM [T2S.BPD.SETT.CVHD]..... 75

16 FIGURE 3-3: BUSINESS PROCESS DIAGRAM [T2S.BPD.SETT.COSD] 79

17 FIGURE 3-4: BUSINESS PROCESS DIAGRAM [T2S.BPD.SETT.ACOL] 90

18 FIGURE 3-5: BUSINESS PROCESS DIAGRAM [T2S.BPD.SETT.RBSP] 97

19 FIGURE 3-6: ENRICH SETTLEMENT RESTRICTION [T2S.BPD.SETT.RBSP.02.01] 99

20 FIGURE 3-7: BUSINESS PROCESS DIAGRAM [T2S.BPD.SETT.UUSP]..... 104

21 FIGURE 3-8: ENRICH SETTLEMENT RESTRICTION [T2S.BPD.SETT.UUSP.01.01] 105

22 FIGURE 3-9: BUSINESS PROCESS DIAGRAM [T2S.BPD.SETT.EARM] 110

23 FIGURE 3-10: BUSINESS PROCESS DIAGRAM [T2S.BPD.SETT.UEAR] 116

24 FIGURE 3-11: BUSINESS PROCESS DIAGRAM [T2S.BPD.SETT.RBCB] 121

25 FIGURE 3-12: ENRICH SETTLEMENT RESTRICTION [T2S.BPD.SETT.RBCB.02.01]..... 123

26 FIGURE 3-13: BUSINESS PROCESS DIAGRAM [T2S.BPD.SETT.UUCB]..... 128

27 FIGURE 3-14: ENRICH SETTLEMENT RESTRICTION [T2S.BPD.SETT.UUCB.01.01] 129

28 FIGURE 3-15: BUSINESS PROCESS DIAGRAM [T2S.BPD.SETT.HOLD] 134

29 FIGURE 3-16: BUSINESS PROCESS DIAGRAM [T2S.BPD.SETT.RELE] 140

30 FIGURE 3-17: BUSINESS PROCESS DIAGRAM [T2S.BPD.SETT.CINS] 146

31 FIGURE 3-18: BUSINESS PROCESS DIAGRAM [T2S.BPD.SETT.CIPM] 153

32 FIGURE 3-19: BUSINESS PROCESS DIAGRAM [T2S.BPD.SETT.CIBM]..... 159

33 FIGURE 3-20: BUSINESS PROCESS DIAGRAM [T2S.BPD.SETT.AINS]..... 164

34 FIGURE 4-1: BUSINESS PROCESS DIAGRAM [T2S.BPD.SETT.REPO]..... 172

35 FIGURE 4-2: BUSINESS PROCESS DIAGRAM [T2S.BPD.SETT.ISSU] 177

36 FIGURE 4-3: BUSINESS PROCESS DIAGRAM [T2S.BPD.SETT.LEND] 184

1	FIGURE 4-4: BUSINESS PROCESS DIAGRAM [T2S.BPD.SETT.BTOB]	189
2	FIGURE 4-5: BUSINESS PROCESS DIAGRAM [T2S.BPD.SETT.BASK]	192
3	FIGURE 4-6: BUSINESS PROCESS DIAGRAM [T2S.BPD.SETT.CSTR]	195
4	FIGURE 4-7: EXAMPLE OF COUPON STRIPPING [T2S.BPD.SETT.CSTR.02]	197
5	FIGURE 4-8: BUSINESS PROCESS DIAGRAM [T2S.BPD.SETT.CREC].....	199
6	FIGURE 4-9: EXAMPLE OF COUPON RECONSTITUTION [T2S.BPD.SETT.CREC]	202
7	FIGURE 4-10: BUSINESS PROCESS DIAGRAM [T2S.BPD.SETT.BISO]	205
8	FIGURE 4-11: BUSINESS PROCESS DIAGRAM [T2S.BPD.SETT.FNDS].....	210
9	FIGURE 4-12: DOMESTIC SUBSCRIPTION OF FUND SHARES IN THE CONTEXT OF T2S [T2S.BPD.SETT.ICSD.04.01].....	214
10	FIGURE 4-13: CROSS CSD SUBSCRIPTION OF FUND SHARES IN THE CONTEXT OF T2S [T2S.BPD.SETT.ICSD.04.01]	215
11	FIGURE 5-1: BUSINESS PROCESS DIAGRAM [T2S.BPD.SETT.SECD].....	219
12	FIGURE 5-2: SECURITIES DISTRIBUTION IN THE CONTEXT OF T2S [T2S.BPD.SETT.SECD.04.02].....	224
13	FIGURE 5-3: BUSINESS PROCESS DIAGRAM [T2S.BPD.SETT.CSHD]	228
14	FIGURE 5-4: CASH DISTRIBUTION IN THE CONTEXT OF T2S [T2S.BPD.SETT.CSHD.02.02].....	231
15	FIGURE 5-5: BUSINESS PROCESS DIAGRAM [T2S.BP.SETT.MAND].....	235
16	FIGURE 5-6: SECURITIES REMOVAL IN THE CONTEXT OF T2S [T2S.BP.SETT.MAND.03.02]	238
17	FIGURE 5-7: SECURITIES DISTRIBUTION IN THE CONTEXT OF T2S [T2S.BP.SETT.MAND.03.02].....	239
18	FIGURE 5-8: CREDIT OF CASH IN THE CONTEXT OF T2S [T2S.BP.SETT.MAND.03.02]	240
19	FIGURE 5-9: BUSINESS PROCESS DIAGRAM [T2S.BPD.SETT.VOLU]	243
20	FIGURE 5-10: BUSINESS PROCESS DIAGRAM [T2S.BPD.SETT.RGOP]	250
21	FIGURE 5-11: BUSINESS PROCESS DIAGRAM [T2S.BPD.SETT.MCLA]	253
22	FIGURE 5-12: BUSINESS PROCESS DIAGRAM [T2S.BPD.SETT.TRAN]	264
23	FIGURE 5-13: BUSINESS PROCESS DIAGRAM [T2S.BPD.SETT.BPRO].....	275
24	FIGURE 6-1: BUSINESS PROCESS DIAGRAM [T2S.BPD.LQMG.INBD]	280
25	FIGURE 6-2: BUSINESS PROCESS DIAGRAM [T2S.BPD.LQMG.OTBD/SCEN. A].....	286
26	FIGURE 6-3: BUSINESS PROCESS DIAGRAM [T2S.BPD.LQMG.OTBD/SCEN. B].....	286
27	FIGURE 6-4: BUSINESS PROCESS DIAGRAM [T2S.BPD.LQMG.MLPT]	294
28	FIGURE 6-5: BUSINESS PROCESS DIAGRAM [T2S.BPD.LQMG.INLT/SCEN. A]	296
29	FIGURE 6-6: BUSINESS PROCESS DIAGRAM [T2S.BPD.LQMG.INLT/SCEN. B].....	297
30	FIGURE 6-7: BUSINESS PROCESS DIAGRAM [T2S.BPD.LQMT.EODC]	303
31	FIGURE 7-1: BUSINESS PROCESS DIAGRAM [T2S.BPD.STDA.MSEC]	312
32	FIGURE 7-2: BUSINESS PROCESS DIAGRAM [T2S.BPD.STDA.MSAC].....	319
33	FIGURE 7-3: BUSINESS PROCESS DIAGRAM [T2S.BPD.STDA.PTYC]	327
34	FIGURE 7-4: BUSINESS PROCESS DIAGRAM [T2S.BPD.STDA.MPBK].....	332
35	FIGURE 7-5: BUSINESS PROCESS DIAGRAM [T2S.BPD.STDA.MDCA]	338
36	FIGURE 7-6: BUSINESS PROCESS DIAGRAM [T2S.BPD.STDA.MRAC]	345
37	FIGURE 7-7: BUSINESS PROCESS DIAGRAM [T2S.BPD.SETT.MMSG].....	349

1	FIGURE 7-8: BUSINESS PROCESS DIAGRAM [T2S.BPD.SETT.MMSG]\.....	351
2	FIGURE 7-9: BUSINESS PROCESS DIAGRAM [T2S.BPD.SETT.MROL]	354
3	FIGURE 7-10: BUSINESS PROCESS DIAGRAM [T2S.BPD.STDA.MRES]	359
4	FIGURE 7-11: RULE SETS IN T2S [T2S.BPD.STD.MRES.01.01]	361
5	FIGURE 7-12: BUSINESS PROCESS DIAGRAM [T2S.BPD.STDA.MCOS].....	367
6	FIGURE 7-13: BUSINESS PROCESS DIAGRAM [T2S.BPD.STDA.MCSL]	372
7	FIGURE 7-14: BUSINESS PROCESS DIAGRAM [T2S.BPD.STDA.MMLP]	378
8	FIGURE 7-15: BUSINESS PROCESS DIAGRAM [T2S.BPD.STDA.MLTO].....	382
9	FIGURE 7-16: BUSINESS PROCESS DIAGRAM [T2S.BPD.STD.MMSA].....	405
10	FIGURE 7-17: BUSINESS PROCESS DIAGRAM [T2S.BPD.STDA.MUSE]	411
11	FIGURE 7-18: BUSINESS PROCESS DIAGRAM [T2S.BPD.STDA.MLIM]	415
12	FIGURE 8-1: BUSINESS PROCESS DIAGRAM [T2S.BPD.STDA.BSEC]	420
13	FIGURE 8-2: BUSINESS PROCESS DIAGRAM [T2S.BPD.STDA.BSAC].....	425
14	FIGURE 8-3: BUSINESS PROCESS DIAGRAM [T2S.BPD.STDA.BPTY]	431
15	FIGURE 8-4: BUSINESS PROCESS DIAGRAM [T2S.BPD.STDA.BDCA]	436
16	FIGURE 8-5: BUSINESS PROCESS DIAGRAM [T2S.BPD.STD.BRTG]	442
17	FIGURE 9-1: BUSINESS PROCESS DIAGRAM [T2S.BPD.INFO.REPT]	446
18	FIGURE 9-2: BUSINESS PROCESS DIAGRAM [T2S.BPD.INFO.QUIRE]	449
19	FIGURE 10-1: BUSINESS PROCESS DIAGRAM [T2S.BPD.SUPP.INVO]	452
20	FIGURE 10-2: BUSINESS PROCESS DIAGRAM [T2S.BPD.SUPP.ARCH]	457
21	FIGURE 10-3: BUSINESS PROCESS DIAGRAM [T2S.BPD.SUPP.FEYE]	460
22	FIGURE 11-1: INTRA-CSD SETTLEMENT WITH INSTRUCTION BY CSD ONLY	464
23	FIGURE 11-2: INTRA-CSD SETTLEMENT WITH BOTH OPTIONS FOR INSTRUCTION.....	466
24	FIGURE 11-3: RESERVATION AND BLOCKING OF CASH BALANCE	467
25		

1 11.4 INDEX OF TABLES

2 TABLE 1-1: BPMN ELEMENTS..... 8

3 TABLE 1-2: BPMN ELEMENTS FOR VARIATIONS..... 15

4 TABLE 2-1: MESSAGES TO T2S [T2S.BPD.SETT.ICSD.03.02] 20

5 TABLE 2-2: MESSAGES FROM T2S [T2S.BPD.SETT.ICSD.04.01]..... 25

6 TABLE 2-3: MAPPING OF T2S GENERATED INSTRUCTION AND T2S PROCESSES [T2S.BPD.SETT.ICSD.04.02] 26

7 TABLE 2-4: MESSAGES FROM T2S [T2S.BPD.SETT.ICSD.04.02]..... 26

8 TABLE 2-5: MESSAGES FROM T2S [T2S.BPD.SETT.ICSD.04.03]..... 27

9 TABLE 2-6: MESSAGES FROM T2S [T2S.BPD.SETT.ICSD.05]..... 28

10 TABLE 2-7: MESSAGES FROM T2S [T2S.BPD.SETT.ICSD.06]..... 29

11 TABLE 2-8: MESSAGES FROM T2S [T2S.BPD.SETT.ICSD.07]..... 29

12 TABLE 2-9: MESSAGES TO T2S [T2S.BPD.SETT.CCSD.02.02] 33

13 TABLE 2-10: MESSAGES FROM T2S [T2S.BPD.SETT.CCSD.03.01] 35

14 TABLE 2-11: MAPPING OF T2S GENERATED INSTRUCTION AND T2S PROCESSES [T2S.BPD.SETT.CCSD.03.02] 36

15 TABLE 2-12: MESSAGES FROM T2S [T2S.BPD.SETT.CCSD.03.02] 36

16 TABLE 2-13: MESSAGES FROM T2S [T2S.BPD.SETT.CCSD.03.03] 37

17 TABLE 2-14: MESSAGES FROM T2S [T2S.BPD.SETT.CCSD.04] 38

18 TABLE 2-15: MESSAGES FROM T2S [T2S.BPD.SETT.CCSD.05] 38

19 TABLE 2-16: MESSAGES FROM T2S [T2S.BPD.SETT.CCSD.07] 40

20 TABLE 2-17: MESSAGES TO T2S [T2S.BPD.SETT.ECSD.02.02] 48

21 TABLE 2-18: MESSAGES FROM T2S [T2S.BPD.SETT.ECSD.03.01]..... 50

22 TABLE 2-19: MAPPING OF T2S GENERATED INSTRUCTION AND T2S PROCESSES [T2S.BPD.SETT.ECSD.03.02] 51

23 TABLE 2-20: MESSAGES FROM T2S [T2S.BPD.SETT.ECSD.03.02]..... 51

24 TABLE 2-21: MESSAGES FROM T2S [T2S.BPD.SETT.ECSD.03.03]..... 52

25 TABLE 2-22: MESSAGES FROM T2S [T2S.BPD.SETT.ECSD.04]..... 53

26 TABLE 2-23: MESSAGES FROM T2S [T2S.BPD.SETT.ECSD.05]..... 53

27 TABLE 2-24: MESSAGES TO T2S [T2S.BPD.SETT.ECSD.02.02] 55

28 TABLE 2-25: MESSAGES FROM T2S [T2S.BPD.SETT.ECSD.10]..... 55

29 TABLE 2-26: MESSAGES FORM T2S [T2S.BPD.SETT.ECSD.12.02]..... 60

30 TABLE 2-27: MESSAGES FROM T2S [T2S.BPD.SETT.ECSD.13.01]..... 62

31 TABLE 2-28: MAPPING OF T2S GENERATED INSTRUCTION AND T2S PROCESSES [T2S.BPD.SETT.ECSD.13.02] 63

32 TABLE 2-29: MESSAGES FROM T2S [T2S.BPD.SETT.ECSD.13.02]..... 63

33 TABLE 2-30: MESSAGES FROM T2S [T2S.BPD.SETT.ECSD.13.03]..... 64

34 TABLE 2-31: MESSAGES FROM T2S [T2S.BPD.SETT.ECSD.15]..... 65

35 TABLE 2-32: MESSAGES FROM T2S [T2S.BPD.SETT.ECSD.21]..... 67

36 TABLE 2-33: MESSAGES FROM T2S [T2S.BPD.SETT.ECSD.22]..... 68

1	TABLE 3-1: MESSAGES AND REPORT FROM T2S [T2S.BPD.SETT.ALEG.01]	71
2	TABLE 3-2: MESSAGES AND REPORT FROM T2S [T2S.BPD.SETT.ALEG.05]	73
3	TABLE 3-3: MESSAGES AND REPORT FROM T2S [T2S.BPD.SETT.ALEG.06]	73
4	TABLE 3-4: MESSAGES AND REPORT FROM T2S [T2S.BPD.SETT.CSDH.01]	76
5	TABLE 3-5: MESSAGES FROM T2S [T2S.BPD.SETT.COSD.01]	81
6	TABLE 3-6: MESSAGES FROM T2S [T2S.BPD.SETT.COSD.02]	82
7	TABLE 3-7: MESSAGES FROM T2S [T2S.BPD.SETT.COSD.03]	83
8	TABLE 3-8: MESSAGES FROM T2S [T2S.BPD.SETT.COSD.08]	85
9	TABLE 3-9: MESSAGES FROM T2S [T2S.BPD.SETT.COSD.09]	86
10	TABLE 3-10: MESSAGES TO T2S [T2S.BPD.SETT.ACOL.01]	91
11	TABLE 3-11: MESSAGES TO T2S [T2S.BPD.SETT.ACOL.02.02]	93
12	TABLE 3-12: MESSAGES FROM T2S [T2S.BPD.SETT.ACOL.03]	93
13	TABLE 3-13: MESSAGES FROM T2S [T2S.BPD.SETT.ACOL.04.01]	94
14	TABLE 3-14: MESSAGES FROM T2S [T2S.BPD.SETT.ACOL.04.02]	95
15	TABLE 3-15: MESSAGES FROM T2S [T2S.BPD.SETT.ACOL.05]	95
16	TABLE 3-16: MESSAGES TO T2S [T2S.BPD.SETT.RBSP.02.02]	99
17	TABLE 3-17: MESSAGES FROM T2S [T2S.BPD.SETT.RBSP.03.01]	101
18	TABLE 3-18: MESSAGES FROM T2S [T2S.BPD.SETT.RBSP.03.02]	102
19	TABLE 3-19: MESSAGES FROM T2S [T2S.BPD.SETT.RBSP.04]	102
20	TABLE 3-20: MESSAGES TO T2S [T2S.BPD.SETT.UUSP.02.02]	105
21	TABLE 3-21: MESSAGES FROM T2S [T2S.BPD.SETT.UUSP.02.01]	107
22	TABLE 3-22: MESSAGES FROM T2S [T2S.BPD.SETT.UUSP.02.02]	108
23	TABLE 3-23: MESSAGES TO T2S [T2S.BPD.SETT.EARM.02.02]	111
24	TABLE 3-24: MESSAGES FROM T2S [T2S.BPD.SETT.EARM.03.01]	113
25	TABLE 3-25: MESSAGES FROM T2S [T2S.BPD.SETT.EARM.03.02]	113
26	TABLE 3-26: MESSAGES FROM T2S [T2S.BPD.SETT.EARM.04]	114
27	TABLE 3-27: MESSAGES FROM T2S [T2S.BPD.SETT.UEAR.02.01]	119
28	TABLE 3-28: MESSAGES FROM T2S [T2S.BPD.SETT.UEAR.02.02]	119
29	TABLE 3-29: MESSAGES TO T2S [T2S.BPD.SETT.RBCB.02.02]	123
30	TABLE 3-30: MESSAGES FROM T2S [T2S.BPD.SETT.RBCB.03.01]	125
31	TABLE 3-31: MESSAGES FROM T2S [T2S.BPD.SETT.RBCB.03.02]	126
32	TABLE 3-32: MESSAGES FROM T2S [T2S.BPD.SETT.RBCB.04]	126
33	TABLE 3-33: MESSAGES TO T2S [T2S.BPD.SETT.UUCB.01.02]	129
34	TABLE 3-34: MESSAGES FROM T2S [T2S.BPD.SETT.UUCB.02.01]	131
35	TABLE 3-35: MESSAGES FROM T2S [T2S.BPD.SETT.UUCB.02.02]	132
36	TABLE 3-36: MESSAGES TO T2S [T2S.BPD.SETT.HOLD.02.02]	136
37	TABLE 3-37: MESSAGES FROM T2S [T2S.BPD.SETT.HOLD.03.01]	137

1	TABLE 3-38: MESSAGES FROM T2S [T2S.BPD.SETT.HOLD.03.02].....	138
2	TABLE 3-39: MESSAGES FROM T2S [T2S.BPD.SETT.HOLD.04.01].....	138
3	TABLE 3-40: MESSAGES TO T2S [T2S.BPD.SETT.RELE.02.02].....	142
4	TABLE 3-41: MESSAGES FROM T2S [T2S.BPD.SETT.RELE.03.01].....	143
5	TABLE 3-42: MESSAGES FROM T2S [T2S.BPD.SETT.RELE.03.02].....	144
6	TABLE 3-43: MESSAGES FROM T2S [T2S.BPD.SETT.RELE.04.01].....	144
7	TABLE 3-44: MESSAGES TO T2S [T2S.BPD.SETT.CINS.01.02]	147
8	TABLE 3-45: MESSAGES FROM T2S [T2S.BPD.SETT.CINS.02.01].....	149
9	TABLE 3-46: MESSAGES FROM T2S [T2S.BPD.SETT.CINS.02.02].....	149
10	TABLE 3-47: MESSAGES FROM T2S [T2S.BPD.SETT.CINS.03].....	150
11	TABLE 3-48: MESSAGES TO T2S [T2S.BPD.SETT.CIPM.01.02].....	155
12	TABLE 3-49: MESSAGES FROM T2S [T2S.BPD.SETT.CIPM.02.01]	156
13	TABLE 3-50: MESSAGES FROM T2S [T2S.BPD.SETT.CIPM.02.02].....	156
14	TABLE 3-51: MESSAGES TO T2S [T2S.BPD.SETT.CIBM.01.02]	160
15	TABLE 3-52: MESSAGES FROM T2S [T2S.BPD.SETT.CIBM.02.01].....	162
16	TABLE 3-53: MESSAGES FROM T2S [T2S.BPD.SETT.CIBM.02.02].....	162
17	TABLE 3-54: MESSAGES TO T2S [T2S.BPD.SETT.AINS.02.02]	166
18	TABLE 3-55: MESSAGES TO T2S [T2S.BPD.SETT.AINS.03.01]	167
19	TABLE 4-1: REPO TRANSACTION TYPES [T2S.BPD.SETT.REPO.02.01].....	174
20	TABLE 4-2: REPO INSTRUCTION DETAILS [T2S.BPD.SETT.REPO.02.01].....	175
21	TABLE 4-3: MESSAGES TO T2S [T2S.BPD.SETT.ISSU.02.02].....	179
22	TABLE 4-4: MESSAGES FROM T2S [T2S.BPD.SETT.ISSU.03.01]	180
23	TABLE 4-5: MESSAGES FROM T2S [T2S.BPD.SETT.ISSU.03.02]	181
24	TABLE 4-6: MESSAGES FROM T2S [T2S.BPD.SETT.ISSU.03.03]	181
25	TABLE 4-7: INSTRUCTION TYPES FOR SECURITIES LENDING [T2S.BPD.SETT.LEND.02.01].....	185
26	TABLE 4-8: SECURITIES TRANSACTION TYPES FOR SECURITIES LENDING [T2S.BPD.SETT.LEND.02.01].....	186
27	TABLE 4-9: MESSAGES TO T2S [T2S.BPD.SETT.LEND.02.02].....	187
28	TABLE 4-10: MESSAGES TO T2S [T2S.BPD.SETT.BTOB.01.02]	190
29	TABLE 4-11: MESSAGES TO T2S [T2S.BPD.SETT.BASK.01.02]	193
30	TABLE 4-12: MESSAGES TO AND FROM T2S [T2S.BPD.SETT.CREC.01].....	200
31	TABLE 4-13: SETTLEMENT INSTRUCTION FOR COUPON RECONSTITUTION [T2S.BPD.SETT.CREC.03].....	201
32	TABLE 4-14: MESSAGES TO T2S [T2S.BPD.SETT.FNDS.02.02]	211
33	TABLE 4-15: MESSAGES TO T2S [T2S.BPD.SETT.FNDS.05.02]	213
34	TABLE 4-16: MESSAGES FROM T2S [T2S.BPD.SETT.ICSD.04.01].....	213
35	TABLE 5-1: MESSAGES TO AND FROM T2S [T2S.BPD.SETT.SECD.02.01].....	221
36	TABLE 5-2: INSTRUCTION FOR SECURITIES DISTRIBUTION [T2S.BPD.SETT.SECD.04.01].....	223
37	TABLE 5-3: MESSAGES TO T2S [T2S.BPD.SETT.SECD.04.02]	225

1	TABLE 5-4: MESSAGES FROM T2S [T2S.BPD.SETT.SECD.05.01].....	225
2	TABLE 5-5: MESSAGES FROM T2S [T2S.BPD.SETT.SECD.05.02].....	226
3	TABLE 5-6: SETTLEMENT INSTRUCTION TYPES FOR CASH DISTRIBUTION [T2S.BPD.SETT.CSHD.02.01]	229
4	TABLE 5-7: MESSAGES TO T2S [T2S.BPD.SETT.CSHD.02.02]	231
5	TABLE 5-8: MESSAGES FROM T2S [T2S.BPD.SETT.CSHD.03]	232
6	TABLE 5-9: SETTLEMENT INSTRUCTION TYPES FOR MANDATORY REORGANISATION [T2S.BP.SETT.MAND.03.01] ...	237
7	TABLE 5-10: MESSAGES TO T2S [T2S.BP.SETT.MAND.03.02]	240
8	TABLE 5-11: MESSAGES FROM T2S [T2S.BP.SETT.MAND.04]	241
9	TABLE 5-12: INSTRUCTION TYPES [T2S.BPD.SETT.VOLU.04.01].....	246
10	TABLE 5-13: INSTRUCTION TYPES [T2S.BPD.SETT.VOLU.04.01].....	247
11	TABLE 5-14: MESSAGES TO AND FROM T2S [T2S.BPD.SETT.MCLA.02].....	255
12	TABLE 5-15: SETTLEMENT INSTRUCTION TYPES FOR MARKET CLAIMS [T2S.BPD.SETT.MCLA.05.01]	259
13	TABLE 5-16: MESSAGES TO T2S [T2S.BPD.SETT.MCLA.05.02]	260
14	TABLE 5-17: MESSAGES FROM T2S [T2S.BPD.SETT.MCLA.06.01]	260
15	TABLE 5-18: MESSAGES FROM T2S [T2S.BPD.SETT.MCLA.06.02]	261
16	TABLE 5-19: MESSAGES FROM T2S [T2S.BPD.SETT.MCLA.07]	262
17	TABLE 5-20: MESSAGES TO AND FROM T2S [T2S.BPD.SETT.TRAN.02]	266
18	TABLE 5-21 CSD (IOC) [CCP] ACTIONS IN T2S [T2S.BPD.SETT.TRAN.04].....	267
19	TABLE 5-22: MESSAGES TO AND FROM T2S [T2S.BPD.SETT.TRAN.04].....	269
20	TABLE 5-23: MESSAGES TO T2S [T2S.BPD.SETT.TRAN.05.02].....	271
21	TABLE 5-24: MESSAGES FROM T2S [T2S.BPD.SETT.TRAN.06.01].....	272
22	TABLE 5-25: MESSAGES FROM T2S [T2S.BPD.SETT.TRAN.06.02].....	273
23	TABLE 5-26: MESSAGES FROM T2S [T2S.BPD.SETT.TRAN.07]	273
24	TABLE 5-27: MESSAGES TO AND FROM T2S [T2S.BPD.SETT.BPRO.02.01].....	276
25	TABLE 6-1: MESSAGES TO T2S [T2S.BPD.LQMG.INBD.02.03].....	281
26	TABLE 6-2: MESSAGES FROM T2S [T2S.BPD.LQMG.INBD.03.01].....	282
27	TABLE 6-3: MESSAGES FROM T2S [T2S.BPD.LQMG.INBD.03.02].....	283
28	TABLE 6-4: MESSAGES FROM T2S [T2S.BPD.LQMG.INBD.03.03].....	284
29	TABLE 6-5: MESSAGES TO T2S [T2S.BPD.LQMG.OTBD.02.02]	288
30	TABLE 6-6: MESSAGES FROM T2S [T2S.BPD.LQMG.OTBD.03].....	288
31	TABLE 6-7: MESSAGES TO T2S [T2S.BPD.LQMG.OTBD.04.02]	290
32	TABLE 6-8: MESSAGES FROM T2S [T2S.BPD.LQMG.OTBD.05.01].....	291
33	TABLE 6-9: MESSAGES FROM T2S [T2S.BPD.LQMG.OTBD.05.02].....	291
34	TABLE 6-10: MESSAGES FROM T2S [T2S.BPD.LQMG.OTBD.05.03].....	292
35	TABLE 6-11: MESSAGES TO T2S [T2S.BPD.LQMG.OTBD.02.02]	298
36	TABLE 6-12: MESSAGES FROM T2S [T2S.BPD.LQMG.OTBD.05.01].....	299
37	TABLE 6-13: MESSAGES FROM T2S [T2S.BPD.LQMG.OTBD.05.02].....	300

1	TABLE 6-14: MESSAGES FROM T2S [T2S.BPD.LQMG.OTBD.05.03].....	301
2	TABLE 6-15: MESSAGES FROM T2S [T2S.BPD.STDA.EODC.01.01].....	304
3	TABLE 6-16: MESSAGES FROM T2S [T2S.BPD.STDA.EODC.01.02].....	305
4	TABLE 6-17: MESSAGES FROM T2S [T2S.BPD.STDA.EODC.01.03].....	305
5	TABLE 6-18: MESSAGES FROM T2S [T2S.BPD.STDA.EODC.02.01].....	306
6	TABLE 6-19: MESSAGES FROM T2S [T2S.BPD.STDA.EODC.02.02].....	307
7	TABLE 6-20: MESSAGES FROM T2S [T2S.BPD.STDA.EODC.02.03].....	307
8	TABLE 6-21: MESSAGES FROM T2S [T2S.BPD.STDA.EODC.03].....	309
9	TABLE 6-22: MESSAGES FROM T2S [T2S.BPD.STDA.EODC.04].....	310
10	TABLE 7-1: MESSAGES TO T2S [T2S.BPD.STDA.MSEC.02.02/CREATION].....	314
11	TABLE 7-2: MESSAGES TO T2S [T2S.BPD.STDA.MSEC.02.02/AMENDMENT].....	315
12	TABLE 7-3: MESSAGES TO T2S [T2S.BPD.STDA.MSEC.02.02/DELETION].....	316
13	TABLE 7-4: MESSAGES FROM T2S [T2S.BPD.STDA.MSEC.03/CREATION].....	316
14	TABLE 7-5: MESSAGES FROM T2S [T2S.BPD.STDA.MSEC.03/AMENDMENT].....	317
15	TABLE 7-6: MESSAGES FROM T2S [T2S.BPD.STDA.MSEC.03/DELETION].....	317
16	TABLE 7-7: MESSAGES TO T2S [T2S.BPD.STDA.MSAC.01.02/CREATION].....	322
17	TABLE 7-8: MESSAGES TO T2S [T2S.BPD.STDA.MSAC.01.02/AMENDMENT].....	322
18	TABLE 7-9: MESSAGES TO T2S [T2S.BPD.STDA.MSAC.01.02/DELETION].....	323
19	TABLE 7-10: MESSAGES FROM T2S [T2S.BPD.STDA.MSAC.03.01].....	324
20	TABLE 7-11: MESSAGES TO T2S [T2S.BPD.STDA.MSAC.04.02/CREATION].....	325
21	TABLE 7-12: MESSAGES TO T2S [T2S.BPD.STDA.MSAC.04.02/MAINTENANCE].....	325
22	TABLE 7-13: MESSAGES FROM T2S [T2S.BPD.STDA.MSAC.03.01]MESSAGE.....	326
23	TABLE 7-14: MESSAGES TO T2S [T2S.BPD.STDA.MPTY.01.02/CREATION].....	329
24	TABLE 7-15: MESSAGES TO T2S [T2S.BPD.STDA.MPTY.01.02/AMENDMENT].....	330
25	TABLE 7-16: MESSAGES TO T2S [T2S.BPD.STDA.MPTY.01.02/DELETION].....	330
26	TABLE 7-17: MESSAGES FROM T2S [T2S.BPD.STDA.MPTY.03.01].....	331
27	TABLE 7-18: MESSAGES TO T2S [T2S.BPD.STDA.MPBK.01.02/CREATION].....	335
28	TABLE 7-19: MESSAGES TO T2S [T2S.BPD.STDA.MPBK.01.02/AMENDMENT].....	335
29	TABLE 7-20: MESSAGES TO T2S [T2S.BPD.STDA.MPBK.01.02/DELETION].....	335
30	TABLE 7-21: MESSAGES FROM T2S [T2S.BPD.STDA.MPBK.03.01].....	336
31	TABLE 7-22: MESSAGES TO T2S [T2S.BPD.STDA.MDCA.01.02/CREATION].....	341
32	TABLE 7-23: MESSAGES TO T2S [T2S.BPD.STDA.MDCA.01.02/AMENDMENT].....	341
33	TABLE 7-24: MESSAGES TO T2S [T2S.BPD.STDA.MDCA.01.02/DELETION].....	342
34	TABLE 7-25: MESSAGES FROM T2S [T2S.BPD.STDA.MDCA.03.01].....	343
35	TABLE 7-26: RESTRICTION PROCESS TYPES AND OBJECTS AVAILABLE FOR CASE 1 [T2S.BPD.STD.MRES.01.01].....	360
36	TABLE 7-27: RESTRICTION PROCESS TYPES AND OBJECTS AVAILABLE FOR CASE 2 [T2S.BPD.STD.MRES.01.01].....	363
37	TABLE 7-28: RESTRICTION PROCESS TYPES AND OBJECTS AVAILABLE FOR CASE 3 [T2S.BPD.STD.MRES.01.01].....	363

1	TABLE 7-29: MESSAGES TO T2S [T2S.BPD.STDA.MCSL.02.02].....	375
2	TABLE 7-30: MESSAGES FROM T2S [T2S.BPD.STDA.MCSL.03].....	376
3	TABLE 7-31: MESSAGES TO T2S [T2S.BPD.STDA.MLTO.02.02].....	384
4	TABLE 7-32: MESSAGES FROM T2S [T2S.BPD.STDA.MLTO.03.01].....	385
5	TABLE 7-33: MESSAGES FROM T2S [T2S.BPD.STDA.MLTO.03.02].....	386
6	TABLE 7-34: MESSAGES FROM T2S [T2S.BPD.STDA.MACE.09.01].....	397
7	TABLE 7-35: MESSAGES FROM T2S [T2S.BPD.STDA.MACE.12.01].....	400
8	TABLE 7-36: MESSAGES FROM T2S [T2S.BPD.STDA.MACE.15.01].....	403
9	TABLE 7-37: MESSAGES TO T2S [T2S.BPD.STDA.MLIM.02.02].....	416
10	TABLE 7-38: MESSAGES FROM T2S [T2S.BPD.STDA.MLIM.03.01].....	418
11	TABLE 7-39: MESSAGES FROM T2S [T2S.BPD.STDA.MLIM.03.02].....	418
12	TABLE 8-1: MESSAGES TO T2S [T2S.BPD.STDA.BSEC.02.02].....	421
13	TABLE 8-2: MESSAGES FROM T2S [T2S.BPD.STDA.BSEC.03.01].....	422
14	TABLE 8-3: MESSAGES FROM T2S [T2S.BPD.STDA.BSEC.03.02].....	423
15	TABLE 8-4: MESSAGES TO T2S [T2S.BPD.STDA.BSAC.02.02].....	426
16	TABLE 8-5: MESSAGES FROM T2S [T2S.BPD.STDA.BSAC.03.01].....	428
17	TABLE 8-6: MESSAGES FROM T2S [T2S.BPD.STDA.BSAC.03.02].....	429
18	TABLE 8-7: MESSAGES TO AND FROM T2S [T2S.BPD.STDA.BPTY.02.02].....	432
19	TABLE 8-8: MESSAGES FORM T2S [T2S.BPD.STDA.BPTY.03.01].....	434
20	TABLE 8-9: MESSAGES FORM T2S [T2S.BPD.STDA.BPTY.03.02].....	434
21	TABLE 8-10: MESSAGES TO T2S [T2S.BPD.STDA.BDCA.02.02].....	438
22	TABLE 8-11: MESSAGES FROM T2S [T2S.BPD.STDA.BDCA.03.01].....	439
23	TABLE 8-12: MESSAGES FROM T2S [T2S.BPD.STDA.BDCA.03.02].....	440
24	TABLE 10-1: MESSAGES FROM T2S [T2S.BPD.SUPP.INVO.01.01].....	454
25	TABLE 10-2: MESSAGES FROM T2S [T2S.BPD.SUPP.INVO.01.02].....	454
26	TABLE 11-1: OVERVIEW OF T2S ACTORS' INVOLVEMENT IN BUSINESS PROCESSES	468